

BMW Motorrad



The Ultimate  
Riding Machine

# Rider's Manual S 1000 XR

## Vehicle data/dealership details

### Vehicle data

---

Model

---

Vehicle Identification Number

---

Colour code

---

Date of first registration

---

Registration number

### Dealership details

---

Person to contact in Service department

---

Ms/Mr

---

Phone number

---

Dealership address/phone number (company stamp)

## **Welcome to BMW**

We congratulate you on your choice of a vehicle from BMW Motorrad and welcome you to the community of BMW riders. Familiarise yourself with your new vehicle so that you can ride it safely and confidently in all traffic situations.

### **About this Rider's Manual**

Please read this Rider's Manual carefully before starting to use your new BMW. It contains important information on how to operate the controls and how to make the best possible use of all your BMW's technical features. In addition, it contains information on maintenance and care to help you maintain your vehicle's reliability and safety, as well as its value.

### **Suggestions and criticism**

If you have questions concerning your motorcycle, your authorised BMW Motorrad dealer will gladly provide advice and assistance.

We hope you will enjoy riding your BMW and that all your journeys will be pleasant and safe

BMW Motorrad.

01 41 8 559 431



# Table of Contents

<b>1 General instructions ....</b>	<b>5</b>	<b>4 Operation.....</b>	<b>37</b>	LAPTIMER .....	71
Overview .....	6	Ignition .....	38	RACE INFO .....	76
Abbreviations and symbols .....	6	Emergency off switch (kill switch) .....	40	SETUP RACETRACK.....	82
Equipment .....	7	Lights .....	40	<b>5 Adjustment.....</b>	<b>87</b>
Technical data .....	7	Daytime riding light.....	41	Windscreen .....	88
Actuality.....	7	Hazard warning flashers.....	45	Mirrors .....	88
<b>2 General views .....</b>	<b>9</b>	Turn indicators .....	45	Headlight.....	89
General view, left side .....	11	Multifunction display .....	47	Brakes .....	90
General view, right side .....	13	Anti-theft alarm.....	50	Spring preload .....	90
Underneath the seat .....	14	Clock.....	52	Damping .....	92
Multifunction switch, left .....	15	Automatic Stability Con- trol .....	52	<b>6 Riding.....</b>	<b>95</b>
Multifunction switch, right .....	17	Dynamic Traction Control .....	53	Safety instructions .....	96
Instrument panel .....	18	Anti-lock brake system.....	54	Comply with checklist .....	99
<b>3 Status indicators .....</b>	<b>19</b>	Electronic Suspension Ad- justment.....	55	Starting.....	99
Warning and telltale lights .....	20	Riding mode .....	56	Running in .....	103
Multifunction display .....	21	Cruise-control system.....	59	Shifting gear .....	104
Warnings .....	22	Heated handlebar grips .....	61	Brakes .....	105
		Seat.....	62	Parking your motor- cycle .....	108
		SETUP MENU .....	64	Refuelling .....	109
		SETUP EQUIPMENT .....	68	Securing motorcycle for transportation .....	110

<b>7 Engineering details</b> .....	<b>113</b>	Tyres .....	138	Preserving paintwork .....	186
General instructions .....	114	Rims and tyres .....	139	Restoring motorcycle to use .....	186
Anti-lock brake system .....	114	Wheels .....	139	<b>11 Technical data</b> .....	<b>187</b>
Traction control .....	117	Lighting .....	149	Troubleshooting chart .....	188
Dynamic ESA .....	118	Body panels .....	154	Threaded fasteners .....	189
Riding mode .....	119	Jump-starting .....	156	Fuel .....	191
Riding mode RAIN .....	120	Battery .....	157	Engine oil .....	191
Riding mode ROAD .....	121	Fuses .....	162	Engine .....	192
Riding mode DYNAMIC ...	122	Chain .....	163	Clutch .....	193
Riding mode DYNAMIC PRO .....	123	<b>9 Accessories</b> .....	<b>167</b>	Transmission .....	193
Deactivatable suspension and running-gear control systems .....	125	General instructions .....	168	Rear-wheel drive .....	194
Shift assistant Pro .....	125	Power sockets .....	168	Frame .....	194
<b>8 Maintenance</b> .....	<b>127</b>	Cases .....	169	Running gear .....	195
General instructions .....	128	Topcase .....	172	Brakes .....	196
Toolkit .....	128	Navigation system .....	174	Wheels and tyres .....	196
Front-wheel stand .....	129	Socket for optional accessories .....	179	Electrics .....	198
Rear-wheel stand .....	130	<b>10 Care</b> .....	<b>183</b>	Dimensions .....	199
Engine oil .....	131	Care products .....	184	Weights .....	200
Brake system .....	133	Washing the vehicle .....	184	Riding specifications .....	200
Clutch .....	136	Cleaning easily damaged components .....	185	<b>12 Service</b> .....	<b>201</b>
Coolant .....	137	Paint .....	185	BMW Motorrad Service ...	202
		Laying up the motorcycle .....	186	BMW Motorrad Mobility services .....	202
				Maintenance work .....	202

Maintenance schedule ....	205
Standard BMW service....	206
Confirmation of maintenance work .....	207
Confirmation of service....	212
<b>13 Appendix .....</b>	<b>215</b>
Certificate for electronic immobiliser .....	216
<b>14 Index .....</b>	<b>218</b>

## General instructions

Overview .....	6
Abbreviations and symbols .....	6
Equipment .....	7
Technical data .....	7
Actuality .....	7

## Overview

An important aspect of this Rider's Manual is that it can be used for quick and easy reference. Consulting the extensive index at the end of this Rider's Manual is the fastest way to find information on a particular topic or item. To first read an overview of your motorcycle, please go to Chapter 2. All maintenance and repair work on the motorcycle is documented in Chapter 12. This record of the maintenance work you have had performed on your vehicle is a precondition for generous treatment of goodwill claims. When the time comes to sell your BMW, please remember to hand over this Rider's Manual; it is an important part of the motorcycle.

## Abbreviations and symbols

 **CAUTION** Low-risk hazard. Non-avoidance can lead to slight or moderate injury.



 **WARNING** Medium-risk hazard. Non-avoidance can lead to fatal or severe injury.

 **DANGER** High-risk hazard. Non-avoidance leads to fatal or severe injury.

 **ATTENTION** Special notes and precautionary measures. Non-compliance can lead to damage to the vehicle or accessory and, consequently, to voiding of the warranty.

 **NOTICE** Specific instructions on how to operate, control, adjust or look after items of equipment on the vehicle.

 Indicates the end of an item of information.

- Instruction.
- » Result of an activity.
-  Reference to a page with more detailed information.
- ◁ Indicates the end of a passage relating to specific accessories or items of equipment.
-  Tightening torque.
-  Technical data.
- ABS Anti-lock brake system.
- ASC Automatic Stability Control.
- DTC Dynamic Traction Control.



- DWA Anti-theft alarm (Diebstahlwarnanlage).
- ESA Electronic Suspension Adjustment.
- EWS Electronic immobiliser.
- OE Optional extras.  
The vehicles are assembled complete with all the BMW Motorrad optional extras originally ordered.
- OA Optional accessories.  
You can obtain BMW Motorrad optional accessories through your authorised BMW Motorrad dealer; optional accessories have to be retrofitted to the vehicle.
- VDS Vertical Down Sensor (drop sensor)

## Equipment

When you purchased your BMW motorcycle, you chose a model with individual equipment. This Rider's Manual describes the optional extras (OE) offered by BMW and selected optional accessories (OA). This explains why the manual may also contain descriptions of equipment which you have not ordered. Please note, too, that your motorcycle might not be exactly as illustrated in this manual on account of country-specific differences. If your motorcycle contains equipment that has not been described, its description can be found in a separate manual.

## Technical data

All dimensions, weights and power ratings stated in the Rider's Manual are quoted to the standards and comply with the

tolerance requirements of the Deutsches Institut für Normung e.V. (DIN). Versions for individual countries may differ.

## Actuality

The high safety and quality standards of BMW motorcycles are maintained by constant development work on designs, equipment and accessories. Because of this, your motorcycle may differ from the information supplied in the Rider's Manual. Nor can BMW Motorrad entirely rule out errors and omissions. We hope you will appreciate that no claims can be entertained on the basis of the data, illustrations or descriptions in this manual.





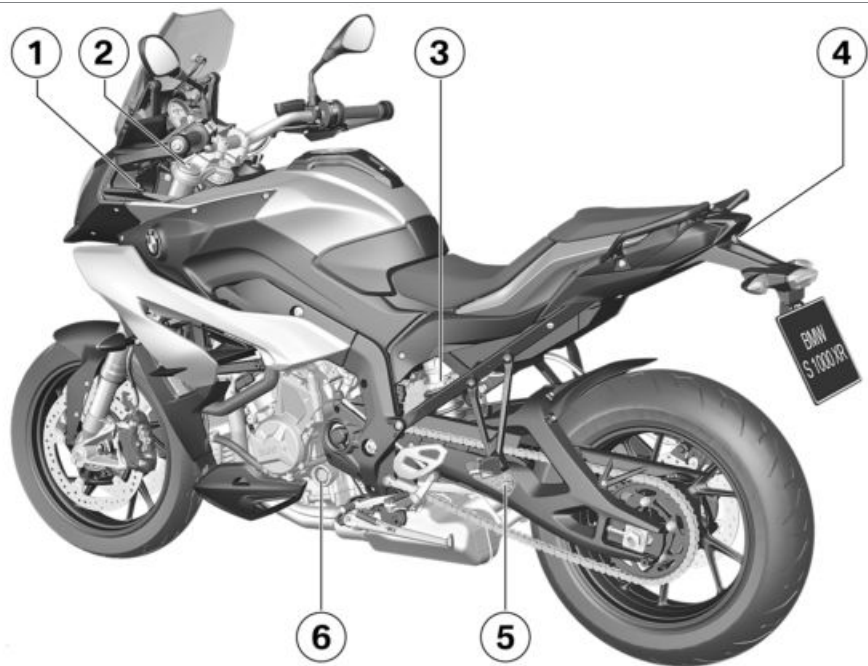

## General views

General view, left side.....	11
General view, right side .....	13
Underneath the seat .....	14
Multifunction switch, left .....	15
Multifunction switch, right.....	17
Instrument panel .....	18







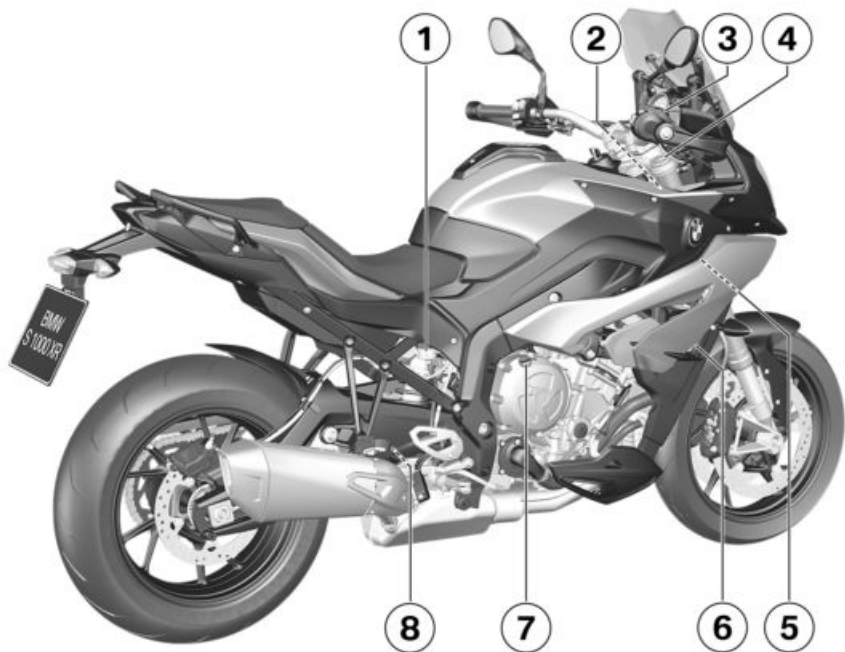

## General view, left side

- 1 Power socket
- 2 – without Dynamic ESA<sup>OE</sup>  
Adjuster for front  
compression-stage  
damping (red scale)  
( 92)
- 3 – without Dynamic ESA<sup>OE</sup>  
Adjuster for spring preload,  
rear ( 90)
- 4 Seat lock ( 62)
- 5 Table of tyre pressures  
Payload table  
Chain settings
- 6 Engine oil level indicator  
( 131)



## General view, right side

- 1 Brake-fluid reservoir, rear  
( 136)
- 2 VIN and type plate (on steering-head, right)
- 3 Brake-fluid reservoir, front  
( 135)
- 4 – without Dynamic ESA<sup>OE</sup>  
Adjuster for front rebound-stage damping (yellow scale) ( 93)
- 5 Check coolant level  
( 137)
- 6 Socket for optional accessories ( 179)
- 7 Oil filler neck ( 132)
- 8 – without Dynamic ESA<sup>OE</sup>  
Adjuster for rear rebound-stage damping (yellow scale) ( 93)

## Underneath the seat

- 1 Fuse box (➔ 162)
- 2 Battery (➔ 157)
- 3 Rider's Manual
- 4 Toolkit (➔ 128)

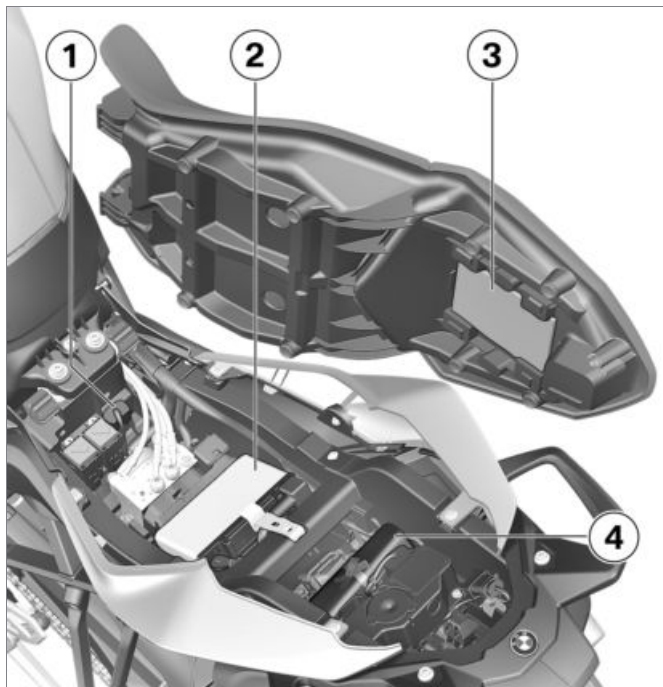



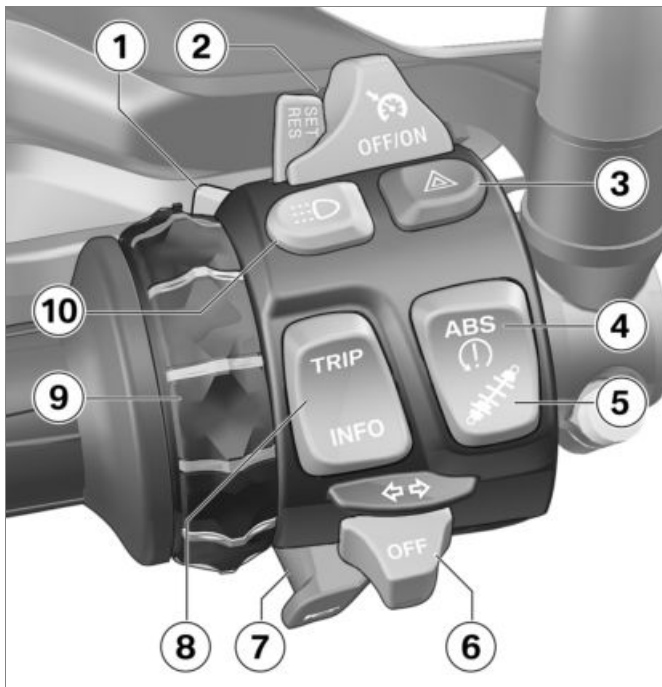









## Multifunction switch, left

- 1 High-beam headlight and headlight flasher (➔ 41)
- 2 – with cruise control<sup>OE</sup>  
Cruise-control system (➔ 59)
- 3 Hazard warning flashers (➔ 45)
- 4 ABS (➔ 54)  
ASC (➔ 52)  
– with Dynamic Traction Control (DTC)<sup>OE</sup>  
DTC (➔ 53)
- 5 – with Dynamic ESA<sup>OE</sup>  
Dynamic ESA (➔ 118)
- 6 Turn indicators (➔ 45)
- 7 Horn

- 8** TRIP/INFO rocker switch  
Multifunction display  
( 47)  
Selecting readings ( 48)  
Resetting tripmeter  
( 49)  
Setting the clock ( 52)  
Selecting submenu  
( 65)  
Individualising lap timer  
( 73)
- 9** – with preparation for navigation system<sup>OE</sup>  
Multi-Controller ( 176)
- 10** – with daytime running light<sup>OE</sup>  
Daytime riding light  
( 44)

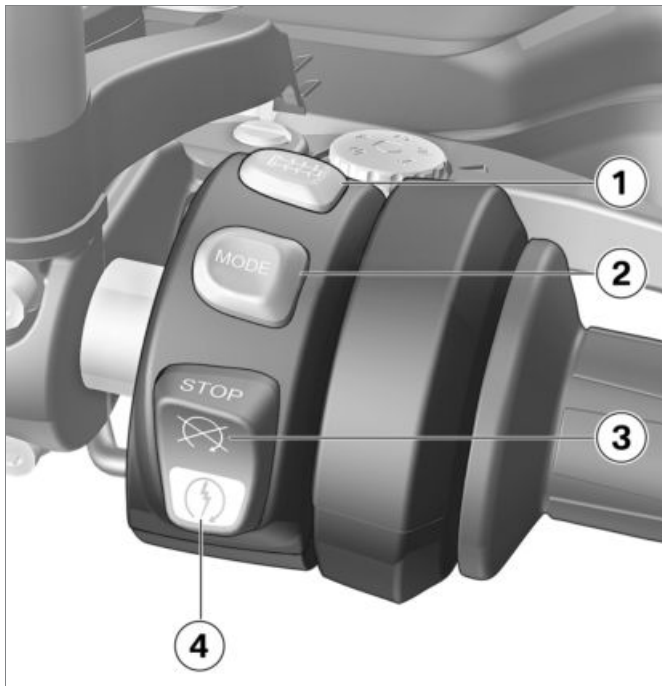

## Multifunction switch, right

- 1 – with heated handlebar grips<sup>OE</sup>  
Heated handlebar grips (➡ 61)
- 2 Control for selecting the ride mode (➡ 57)
- 3 Emergency off switch (kill switch) (➡ 40)
- 4 Starter button  
Start engine (➡ 99)

## Instrument panel

- 1 Panels for warning and telltale lights  
Warning and telltale lights (►► 20)
- 2 Rev. counter
- 3 Gearshift light (►► 104)
- 4 Photosensor (for adapting the brightness of the instrument lighting)  
– with alarm system (DWA)<sup>OE</sup>  
DWA light-emitting diode (►► 50)
- 5 Multifunction display (►► 21)

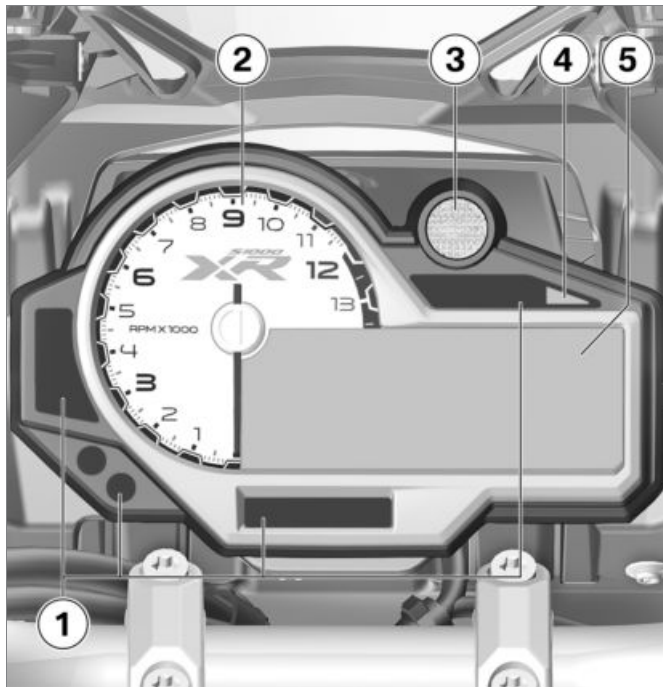

## Status indicators

Warning and telltale lights.....	20
Multifunction display .....	21
Warnings .....	22

## Warning and telltale lights

- 1 ASC warning light (►►► 31)  
– with Dynamic Traction Control (DTC)<sup>OE</sup>
- 2 DTC warning light (►►► 31)
- 3 ABS warning light (►►► 30)
- 4 Turn indicators, left
- 5 General warning light, in combination with warnings in the multifunction display (►►► 22)
- 6 Turn indicators, right
- 7 – with daytime running light<sup>OE</sup>
- 8 Daytime riding light (►►► 44)
- 9 Telltale light for neutral
- 10 High-beam headlight
- 11 Warning light for engine electronics (►►► 27)
- 12 – with cruise control<sup>OE</sup>
- 13 Cruise-control system (►►► 59)

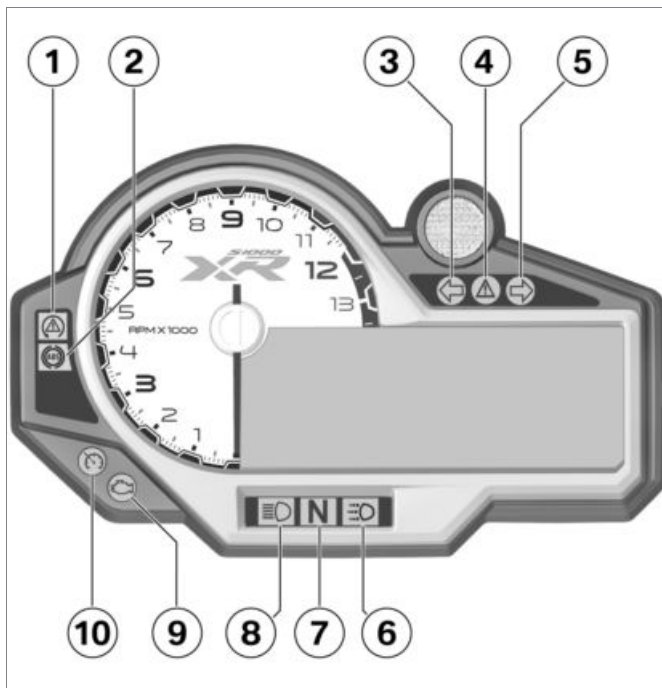

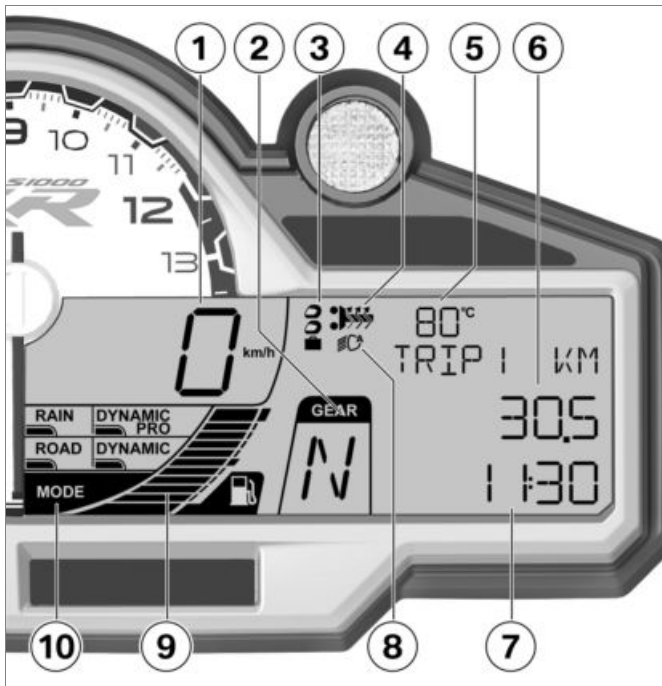

## Multifunction display

- 1 Speedometer
- 2 Gear indicator; "N" indicates neutral.
- 3 – with Dynamic ESA<sup>OE</sup>  
Dynamic ESA adjustment (➔ 118)
- 4 – with heated handlebar grips<sup>OE</sup>  
Heated handlebar grips (➔ 61)
- 5 Coolant temperature
- 6 On-board computer (➔ 48)
- 7 Clock (➔ 52)
- 8 – with daytime running light<sup>OE</sup>  
Automatic for daytime riding light (➔ 43)
- 9 Fuel level

- 10** Riding mode  
 RAIN  
 ROAD  
 Setting riding mode  
 (▶▶▶▶▶ 57)  
 – with Pro riding modes<sup>OE</sup>  
 Additional riding modes  
 DYNAMIC  
 DYNAMIC PRO (with coding plug)

## Warnings

### Mode of presentation

Warnings are indicated by the corresponding warning lights.

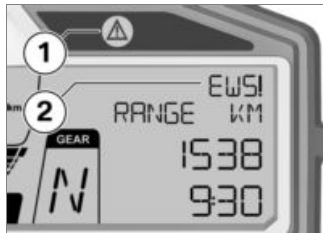

Warnings for which there is no dedicated warning light are indicated by 'General' warning light **1** showing in combination with a warning such as, for example, **2** appearing on the multifunction display. The 'general' warning light shows red or yellow, depending on the urgency of the warning.

If two or more warnings occur at the same time, all the appropriate warning lights and warning symbols appear, alternating with warning words as applicable. The possible warnings are listed on the next pages.









## Warnings, overview

### Warning and telltale lights

### Warning symbols in the display









### Meaning

	lights up red	EWS ! appears on the display	Electronic immobiliser active (►► 27)
	flashes red	Coolant-temperature reading flashes	Coolant temperature too high (►► 27)
	lights up		Engine in emergency-operation mode (►► 27)
	flashes yellow		Engine warning (►► 28)
	lights up		
		LAMP ! appears on the display	Bulbs for flashing turn indicators defective (►► 28)
	lights up yellow	LAMP R ! appears on the display	Rear light defective (►► 28)
	lights up yellow	LAMP F ! appears on the display	Front lights defective (►► 29)

## Warning and telltale lights

## Warning symbols in the display









## Meaning

	lights up yellow	LAMPS ! appears on the display	Rear light and front lights defective (➡ 29)
	lights up yellow	VDS ! appears on the blank display	Motorcycle dropped (➡ 30)
	lights up yellow	VDS ! appears on the display	Drop sensor defective (➡ 30)
	flashes		ABS self-diagnosis not completed (➡ 30)
	lights up		ABS switched off (➡ 30)
	lights up		ABS fault (➡ 30)
	quick-flashes		ASC intervention (➡ 31)
	slow-flashes		ASC self-diagnosis not completed (➡ 31)

## Warning and telltale lights

## Warning symbols in the display





## Meaning

	lights up		ASC switched off (➡ 31)
	lights up		ASC fault (➡ 31)
	quick-flashes		DTC intervention (➡ 31)
	slow-flashes		DTC self-diagnosis not completed (➡ 32)
	lights up		DTC switched off (➡ 32)
	lights up		DTC fault (➡ 32)
	lights up yellow	DWA! appears on the display	DWA battery weak (➡ 33)
	lights up yellow	DWA ! appears on the display	DWA battery flat (➡ 33)

## Warning and telltale lights

## Warning symbols in the display

## Meaning

	lights up yellow	D-ESA ! appears on the display	Dynamic ESA fault (→ 33)
	lights up red	NO CAN appears on the display	CAN open circuit/short circuit (→ 33)
	lights up yellow	NO CODING appears on the display	No coding (→ 34)
	lights up yellow	SERVICE ! appears on the display.	Service-due date has passed (→ 34)
	lights up yellow	FUEL ! appears on the display.	Fuel down to reserve (→ 35)

## Electronic immobiliser active

 General warning light shows red.

EWS ! appears on the display.

Possible cause:

The key being used is not authorised for starting, or communication between key and engine electronics is disrupted.

- Remove all other vehicle keys from the same ring as the key used for the vehicle.
- Use the reserve key.
- Have the defective key replaced, preferably by an authorised BMW Motorrad dealer.

## Coolant temperature too high

 General warning light flashes red.

The coolant-temperature reading flashes.

## ATTENTION

### Riding with overheated engine.

Engine damage

- Compliance with the information set out below is essential.◀

Possible cause:

The coolant temperature is too high.

- If possible, ride in the part-load range to cool down the engine.
- If the coolant temperature is frequently too high, have the fault rectified as soon as possible by a specialist workshop, preferably an authorised BMW Motorrad dealer.

## Engine in emergency-operation mode

 Warning light for engine electronics shows.

## WARNING

### Unusual ride characteristics when engine running in emergency-operation mode.

Risk of accident

- Adapt your style of riding accordingly.
- Avoid accelerating sharply and overtaking.◀

Possible cause:

The engine control unit has diagnosed a fault. The engine is in emergency-operation mode. In exceptional cases, the engine stops and refuses to start.

- Have the fault rectified as quickly as possible by a specialist workshop, preferably

an authorised BMW Motorrad dealer.

- » You can continue to ride, but bear in mind that the usual engine power or the full range of engine rpm might not be available.

### Engine warning



General warning light flashes yellow.



Warning light for engine electronics shows.



### WARNING

### Engine damage when running in emergency-operation mode.

Risk of accident

- Adapt your style of riding accordingly: Ride slowly, avoid sharp accelerating and overtaking.
- If possible, have the vehicle brought in and the fault

rectified by a specialist workshop, preferably an authorised BMW Motorrad dealer.◀

Possible cause:

The engine control unit has diagnosed a fault which may cause severe secondary faults. The engine is in emergency-operation mode.

- Avoid high load and rpm ranges if possible.
- Have the fault rectified as quickly as possible by a specialist workshop, preferably an authorised BMW Motorrad dealer.

- » It is possible to continue to ride but not recommended.

### Bulbs for flashing turn indicators defective

LAMP ! appears on the display.



### WARNING

### Failure of lights on the vehicle adds to possibility of other road users overlooking the vehicle.

Safety risk

- Replace defective bulbs as soon as possible; always carry a complete set of spare bulbs if possible.◀

Possible cause:

Bulb for turn indicator defective.

- Replacing bulbs for front and rear turn indicators (▣▶ 153).

### Rear light defective



General warning light shows yellow.

LAMPR ! appears on the display.

Possible cause:

Bulb for combined rear light and brake light is defective.

- The LED rear light must be replaced. Consult a specialist workshop, preferably an authorised BMW Motorrad dealer.

### Front lights defective



General warning light shows yellow.

LAMPF! appears on the display.



### WARNING

**Failure of lights on the vehicle adds to possibility of other road users overlooking the vehicle.**

Safety risk

- Replace defective bulbs as soon as possible; always carry a complete set of spare bulbs if possible.◀

Possible cause:

Bulb for front parking light is defective.

- Replacing bulb for left parking light (▶▶▶ 150).
- Replacing bulb for right side light (▶▶▶ 151).

Possible cause:

Bulb for low-beam headlight or high-beam headlight is defective.

- Replacing bulbs for low-beam headlight and high-beam headlight (▶▶▶ 149).

Possible cause:

– with daytime running light<sup>OE</sup>

Daytime riding light defective.

- The daytime riding light has to be replaced. Consult a specialist workshop, preferably an authorised BMW Motorrad dealer.

### Rear light and front lights defective



General warning light shows yellow.

LAMPS! appears on the display.

Possible cause:

Bulb for front parking light is defective.

- Replacing bulb for left parking light (▶▶▶ 150).
- Replacing bulb for right side light (▶▶▶ 151).

Possible cause:

Bulb for combined rear light and brake light is defective.

- The LED rear light must be replaced. Consult a specialist workshop, preferably an authorised BMW Motorrad dealer.

## Motorcycle dropped

 General warning light shows yellow.

VDS ! (Vertical Down Sensor) appears on the blank display.

Possible cause:

The drop sensor has detected a drop and has cut out the engine.

- Bring the motorcycle to the upright position.
- Switch the ignition off and then on again or switch the kill switch on and then off again.

## Drop sensor defective

 General warning light shows yellow.

VDS ! (Vertical Down Sensor) appears on the display.

Possible cause:

A defect in the drop sensor has been detected.

- Seek the advice of a specialist workshop, preferably an authorised BMW Motorrad dealer.

## ABS self-diagnosis not completed

 ABS telltale and warning light flashes.

Possible cause:

The ABS is not available, because self-diagnosis did not complete. The motorcycle has to move forward a few metres for the wheel-speed sensors to be tested.

- Pull away slowly. Bear in mind that the ABS is not available until self-diagnosis has completed.

## ABS switched off

 ABS telltale and warning light shows.

Possible cause:

The rider has switched off the ABS.

- ABS Switching on (►► 55).

## ABS fault

 ABS telltale and warning light shows.

Possible cause:

The ABS control unit has detected a fault. The ABS function is not available or the functionality is subject to certain restrictions.

- You can continue to ride the vehicle, but make due provision for the fact that the ABS function is not available or is only conditionally available. Bear in mind the more detailed information on situations that can lead to an ABS fault (►► 115).
- Have the fault rectified as quickly as possible by a specialist workshop, preferably



an authorised BMW Motorrad dealer.

### ASC intervention



ASC telltale and warning light quick-flashes.

The ASC has detected a degree of instability at the rear wheel and has intervened to reduce torque. The warning light flashes for longer than ASC intervention lasts. This affords the rider visual feedback on control intervention even after the critical situation has been dealt with.

### ASC self-diagnosis not completed



ASC telltale and warning light slow-flashes.

Possible cause:



ASC self-diagnosis not completed

The ASC function is not available, because self-diagnosis did not complete. (The motorcycle has to reach a defined minimum speed with the engine running for the wheel-speed sensors to be checked: min 5 km/h)

- Pull away slowly. Bear in mind that the ASC is not available until self-diagnosis has completed.

### ASC switched off



ASC telltale and warning light shows.

Possible cause:

The rider has switched off the ASC.

- ASC Switching on (►► 53).

### ASC fault



ASC telltale and warning light shows.

Possible cause:

The ASC control unit has detected a fault.

- You can continue to ride. Bear in mind that the ASC is not available or the functionality is subject to certain restrictions. Bear in mind the more detailed information on situations that can lead to a ASC fault (►► 117).
- Have the fault rectified as quickly as possible by a specialist workshop, preferably an authorised BMW Motorrad dealer.

### DTC intervention

– with Dynamic Traction Control (DTC)<sup>OE</sup>



DTC telltale light quick-flashes.

The DTC has detected a degree of instability at the rear wheel and has intervened to reduce torque. The warning light flashes for longer than DTC intervention lasts. This affords the rider visual feedback on control intervention even after the critical situation has been dealt with.

### DTC self-diagnosis not completed

– with Dynamic Traction Control (DTC)<sup>OE</sup>



DTC telltale light slow-flashes.

Possible cause:



DTC self-diagnosis not completed

The DTC function is not available, because self-diagnosis did not complete. (The motorcycle has to reach a defined minimum speed with the engine running for the wheel-speed sensors to be checked: min 5 km/h)

- Pull away slowly. Bear in mind that the DTC function is not available until self-diagnosis has completed.

### DTC switched off

– with Dynamic Traction Control (DTC)<sup>OE</sup>



DTC telltale light shows.

Possible cause:

The rider has switched off the DTC system.

- DTC Switching on (▣► 54).

### DTC fault

– with Dynamic Traction Control (DTC)<sup>OE</sup>



DTC telltale light shows.

Possible cause:

The DTC control unit has detected a fault. Bear in mind that the DTC function is not available or the functionality is subject to certain restrictions.

- You can continue to ride. Bear in mind the more detailed information on situations that can lead to a DTC fault (▣► 117).
- Have the fault rectified as quickly as possible by a specialist workshop, preferably

an authorised BMW Motorrad dealer.

### DWA battery weak

– with alarm system (DWA)<sup>OE</sup>



General warning light shows yellow.

DWALO ! appears on the display.



#### NOTICE

This error message shows briefly only after the Pre-Ride-Check completes. ◀

Possible cause:

The integral battery in the anti-theft alarm has lost a significant proportion of its original capacity. There is no assurance of how long the anti-theft alarm can remain operational if the vehicle's battery is disconnected.

- Seek the advice of a specialist workshop, preferably an authorised BMW Motorrad dealer.

### DWA battery flat

– with alarm system (DWA)<sup>OE</sup>



General warning light shows yellow.

DWA ! appears on the display.



#### NOTICE

This error message shows briefly only after the Pre-Ride-Check completes. ◀

Possible cause:

The integral battery in the anti-theft alarm has lost its entire original capacity. There is no assurance that the anti-theft alarm will be operational if the vehicle's battery is disconnected.

- Seek the advice of a specialist workshop, preferably an authorised BMW Motorrad dealer.

### Dynamic ESA fault



General warning light shows yellow.

D-ESA ! appears on the display.

Possible cause:

The Dynamic ESA control unit has detected a fault. In this condition, the motorcycle has too much damping and is uncomfortable to drive, especially on roads in poor condition.

- Have the fault rectified as quickly as possible by a specialist workshop, preferably an authorised BMW Motorrad dealer.

### CAN open circuit/short circuit



General warning light shows red.

NO CAN (Controller Area Network) appears on the display.

Possible cause:

A fault in the Controller Area Network has been detected.

- Seek the advice of a specialist workshop, preferably an authorised BMW Motorrad dealer.

### No coding

 General warning light shows yellow.

NO CODING appears on the display.

Possible cause:

A coding fault has been detected.

- The reading remains visible for 10 seconds before disappearing automatically.
- Seek the advice of a specialist workshop, preferably an authorised BMW Motorrad dealer.

### Service-due date has passed

 General warning light shows yellow.

SERVICE ! appears on the display.

### Service-due indicator

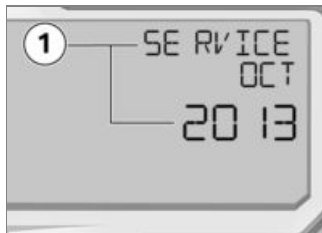

The service-due date **1** shows when a service is due within one month.



When a service is due within 1000 km (US model, 700 miles), countdown distance **1** is shown and counted down in steps of 100 km (US model, 100 miles). This reading appears briefly after the Pre-Ride-Check completes.

 If service is overdue, the due date or the odometer reading at which service was due is accompanied by the 'General' warning light showing yellow. The word "Service" remains permanently visible.

## NOTICE

If the service-due indicator appears more than a month before the service date, the date saved in the instrument cluster must be adjusted. This situation can occur if the battery was disconnected for a prolonged period of time.

If you want to have the date set consult a specialist workshop, preferably an authorised BMW Motorrad dealer. ◀

## Fuel down to reserve



General warning light shows yellow.

FUEL! appears on the display.

## WARNING

**Irregular engine operation or engine shutdown due to lack of fuel.**

Risk of accident. Damage to catalytic converter.

- Do not run the fuel tank dry. ◀

Possible cause:

The fuel tank contains no more than the reserve quantity of fuel.

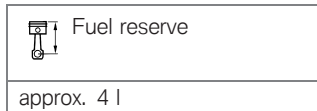

- Refuelling (▶▶ 109).

## Range

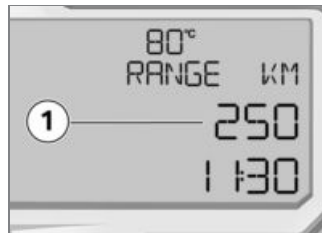

The range readout **1** RANGE indicates how far you can ride with the fuel remaining in the tank. This distance is calculated on the basis of average consumption and the quantity of fuel on board.

– When the motorcycle is propped on its side stand the slight angle of inclination means that the sensor cannot register the fuel level correctly. This is the reason why the range is calculated only when the side stand is in the retracted position.

- The range reading appears automatically on the multifunction display when fuel is down to the reserve level.
- After a refuelling stop, range is recalculated if the amount of fuel in the tank is greater than the reserve quantity.
- The calculated range is only an approximate figure.

## Operation

Ignition.....	38	Cruise-control system .....	59
Emergency off switch (kill switch).....	40	Heated handlebar grips .....	61
Lights.....	40	Seat .....	62
Daytime riding light .....	41	SETUP MENU.....	64
Hazard warning flashers.....	45	SETUP EQUIPMENT.....	68
Turn indicators.....	45	LAPTIMER .....	71
Multifunction display .....	47	RACE INFO.....	76
Anti-theft alarm .....	50	SETUP RACETRACK .....	82
Clock .....	52		
Automatic Stability Control.....	52		
Dynamic Traction Control.....	53		
Anti-lock brake system .....	54		
Electronic Suspension Adjustment.....	55		
Riding mode .....	56		

## Ignition Keys

You receive 2 ignition keys. Please consult the information on the electronic immobiliser (EWS) if a key is lost or mislaid (►► 39). Ignition switch/steering lock, fuel filler cap lock and seat lock are all operated with the same key.

If you wish you can arrange to have the cases and the top-case fitted with locks that can be opened with the ignition key as well. Consult a specialist workshop, preferably an authorised BMW Motorrad dealer.

### Lock the handlebars



#### ATTENTION

**Handlebars turned in wrong direction when motorcycle propped on side stand.**

Risk of damage to parts if vehicle topples.

- On level ground, always turn the handlebars to the left to set the steering lock.
- In all other cases it is the lie of the ground that determines the direction in which the handlebars should be turned. ◀
- If the camber of the roadway permits, turn the handlebars all the way to the left.

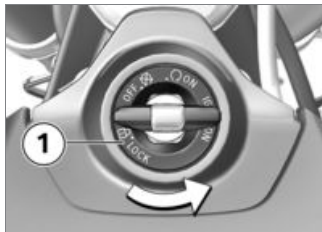

- Turn the vehicle key to position **1**, while moving the handlebars slightly.

- » Ignition, lights and all function circuits switched off.
- » Handlebars are locked.
- » Vehicle key can be removed.

### Switching on ignition



- Insert the vehicle key into the ignition switch and turn it to position **1**.
  - » Side lights and all function circuits are switched on.
  - » Engine can be started.
    - with daytime running light <sup>OE</sup>
  - » When the ignition is switched on the daytime riding light comes on briefly (welcome light). The welcome light goes



out immediately in the following circumstances:

- Turn indicators or hazard warning lights are switched on.
- Light switches are operated.
- Engine is started.<1
- » Pre-Ride-Check is performed. (11111111 100)
- » ABS self-diagnosis is in progress. (11111111 101)
- » ASC self-diagnosis is in progress. (11111111 101)
- with Dynamic Traction Control (DTC)<sup>OE</sup>
- » DTC self-diagnosis is in progress. (11111111 102)<1

## Switching off ignition



- Turn the ignition key to position **1**.
  - » When the ignition is switched off, the instrument cluster remains switched on for a short time and displays any existing fault messages.
  - » Handlebars not locked.
  - » Electrically powered accessories remain operational for a limited period of time.
  - » The battery can be recharged via the socket.
  - » Vehicle key can be removed.

- with daytime running light<sup>OE</sup>
  - » The daytime riding light goes out soon after the ignition is switched off (headlight courtesy delay feature).<1

## Electronic immobiliser EWS

The electronic design of the motorcycle allows it to access data stored in the ignition key by means of a ring antenna located in the ignition switch/steering lock. The engine control unit will not permit the engine to be started unless the key is identified as “authorised”.

### NOTICE

A spare key attached to the same ring as the ignition key used to start the engine could “irritate” the electronics, in which case the enabling signal for starting is not issued. The

EWS ! warning appears in the multifunction display.

Always keep the spare key separately from the ignition key. ◀

If you lose your key, you can have it barred by your authorised BMW Motorrad dealer.

If you wish to do this, you will need to bring all other keys for the motorcycle with you. The engine cannot be started by a barred key, but a key that has been barred can subsequently be reactivated.

You can obtain emergency/extra keys only through an authorised BMW Motorrad dealer. The keys are part of an integrated security system, so the dealer is under an obligation to check the legitimacy of all applications for replacement/extra keys.

## Emergency off switch (kill switch)



- 1 Emergency off switch (kill switch)



### WARNING

#### Operation of the kill switch while riding.

Risk of fall due to rear wheel locking.

- Do not operate the kill switch when riding. ◀

The emergency off switch is a kill switch for switching off the engine quickly and easily.

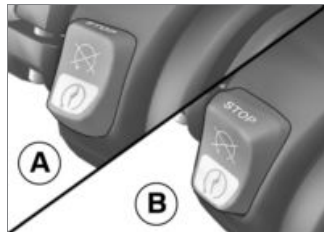

- A Engine switched off  
B Normal operating position (run)

## Lights

### Low-beam headlight and sidelights

The side lights switch on automatically when the ignition is switched on.

## NOTICE

The side lights place a strain on the battery. Do not switch the ignition on for longer than absolutely necessary. ◀

The low-beam headlight switches on automatically when the engine is switched on.

– with daytime running light<sup>OE</sup>

In daytime the daytime riding light can be switched on as an alternative to the low-beam headlight.

### High-beam headlight and headlight flasher

- Switching on ignition (▮▮▮ 38).

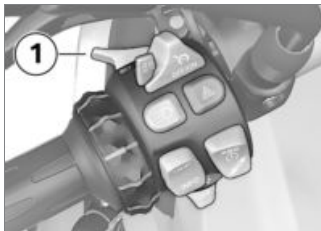

- Push switch **1** forward to switch on the high-beam headlight.
- Pull switch **1** back to operate the headlight flasher.

### Parking lights

- Switching off ignition (▮▮▮ 39).



- Immediately after switching off the ignition, push button **1** to the left and hold it in this position until the parking lights come on.
- Switch the ignition on and off again to switch off the parking lights.

### Daytime riding light

- with daytime running light<sup>OE</sup>

## Automatic or manual daytime riding light

The daytime riding light is switched on and off either automatically or manually. You can switch the automatic function for the daytime riding light on or off in the menu.

### Recommended setting:

- SETUP EQIP: DRL AUTO **ON**  
(DRL: daytime riding light)

You can switch the automatic function for the daytime riding light off temporarily by pressing the button. Pressing the button for the daytime riding light has no effect on the setting in the menu.

## Automatic daytime riding light



### WARNING

The automatic riding light control system cannot replace your personal assess-

## ment of lighting conditions, particularly in foggy or misty weather.

Safety risk

- Manually switch on the low-beam headlight in poor lighting conditions. ◀
- Start engine (▮▮▮ 99).



### NOTICE

The changeover between daytime riding light and low-beam headlight including front side lights can be effected automatically. ◀



Symbol **1** for the automatic daytime riding light appears on the display.

- » If symbol **1** does not appear, this is because the SETUP EQIP : DRL AUTO **OFF** is active. Proceed as follows in order to switch the daytime riding light to automatic:



- Repeatedly short-press INFO **2** until SETUP MENU ENTER appears on the display.
- Long-press INFO **2**.
  - » The SETUP MENU opens.
- Repeatedly short-press TRIP **1** or INFO **2** until SETUP EQUIPMENT ENTER appears on the display.
- Long-press INFO **2**.
  - » The SETUP EQUIPMENT menu opens.
- Repeatedly short-press TRIP **1** or INFO **2** until SETUP EQIP : DRL AUTO appears on the display.

- Long-press INFO **2** to switch automatic daytime riding light ON.
- Long-press TRIP **1** to return to the default reading.

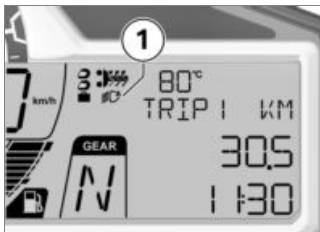

Symbol **1** for the automatic daytime riding light appears on the display.

- » If the ambient brightness decreases below a certain value, the low beam headlight is automatically switched on (e. B. in a tunnel). When sufficient ambient brightness is detected, the

daytime riding light is switched back on.

 The indicator light for the daytime riding light shows if the daytime riding light is active.

### Manual operation of the light when the automatic system is switched on

Automatic for daytime riding light is switched on.



- Press button **1** (e. g. when you ride into a tunnel, and the response of the automatic daytime running light to the

- change in ambient brightness is delayed).
- » Automatic for daytime riding light is switched off.
- » The low-beam headlight and the front side lights are switched on.
- Press button **1** again.
- » Automatic for daytime riding light is re-activated.
- » The daytime riding light is switched on again as soon as ambient light is bright enough.

 The indicator light for the daytime riding light shows if the daytime riding light is active.

## Manual daytime riding light

Automatic for daytime riding light must be switched off.

### WARNING

## Activation of daytime riding light in the dark.

Poorer vision and oncoming traffic dazzled.

- Do not use the daytime running light when it is dark.◀

### NOTICE

By comparison with the low-beam headlight, the daytime running light makes the vehicle more visible to oncoming traffic. This improves daytime visibility.◀

- Start engine (▶▶▶ 99).

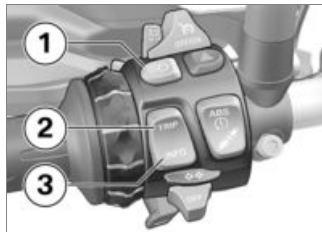

- Repeatedly short-press INFO **3** until SETUP MENU ENTER appears on the display.

- Long-press INFO **3**.
- » The SETUP MENU opens.
- Repeatedly short-press TRIP **2** or INFO **3** until SETUP EQUIPMENT ENTER appears on the display.
- Long-press INFO **3**.
- » The SETUP EQUIPMENT menu opens.
- Repeatedly short-press TRIP **2** or INFO **3** until SETUP EQIP : DRL AUTO appears on the display.
- Long-press INFO **3** to switch automatic daytime riding light OFF.
- Press button **1** to switch on the daytime riding light.
- » The low-beam headlight and the front side lights are switched off.

 The indicator light for the daytime riding light shows if the daytime riding light is active.

- In the dark or in tunnels: Press button **1** again to switch off the

daytime riding light and switch on the low-beam headlight and the front side lights.

## NOTICE

If the high-beam headlight is switched on while the daytime riding light is on, the daytime riding light is switched off after approx. 2 seconds and the high-beam headlight, low-beam headlight and front side lights are switched on.

If the high beam headlight is switched off again, the daytime running light is not automatically reactivated, but must be switched on again if required.◀

## Hazard warning flashers

### Operating hazard warning flashers

- Switching on ignition (▮▮▮▮▶ 38).

## NOTICE

The hazard warning flashers place a strain on the battery. Do not use the hazard warning flashers for longer than absolutely necessary.◀

## NOTICE

If you press a turn-indicator button with the hazard warning flashers switched on, the turn-indicator function is activated instead of the hazard warning flashers, and remains active until you release the button. The hazard warning flashers recommence flashing as soon as the button is released.◀



- Press button **1** to switch on the hazard warning flashers.  
» Ignition can be switched off.
- To switch off the hazard warning flashers, switch on the ignition and press button **1** again.

## Turn indicators

### Operating the turn indicators

- Switching on ignition (▮▮▮▮▶ 38).



- Push button **1** to the left to switch on the left turn indicators.
- Push button **1** to the right to switch on the right turn indicators.
- Centre button **1** to cancel the turn indicators.

**NOTICE**

The turn indicators are cancelled automatically after the defined riding time and distance. The defined time and distance can be set by an authorised BMW Motorrad dealer. ◀

- » Factory setting:
- Riding time = 10 s
  - Distance travelled = 300 m



## Multifunction display Overview, main menu

- 1 Odometer  
Default display  
Selecting readings in multi-function display (►► 48).
  - 2 LAPTIMER (►► 72)
  - 3 RACE INFO (►► 76)
  - 4 SETUP MENU (►► 64)
  - 5 TRIP 1 / TRIP 2  
Resetting tripmeter (►► 49).
  - 6 Average consumption and average speed  
Resetting the average values (►► 49).
- Solid line means: short-press the TRIP/INFO rocker switch.  
- - Broken line means: long-press the TRIP/INFO rocker switch.

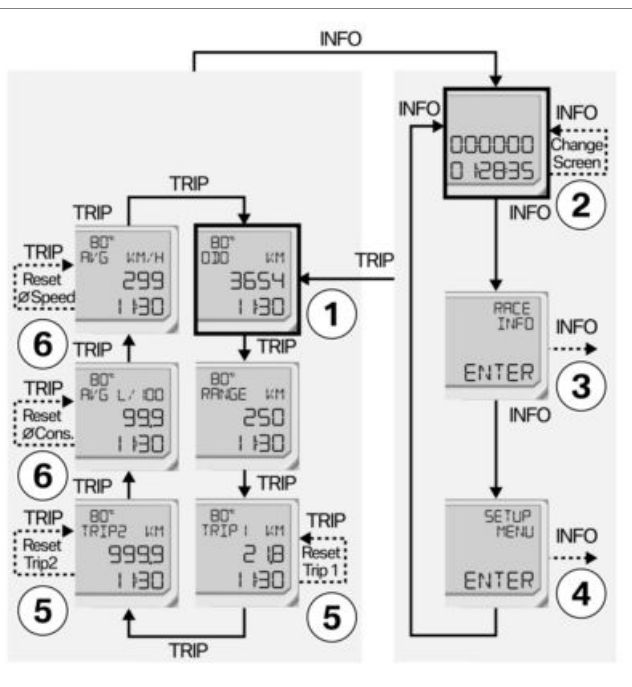

## Selecting readings in multifunction display

- Switch on the ignition.
- » All the information necessary for riding on public roads is presented in the multifunction display by the on-board computer.



- Repeatedly short-press TRIP **1** until the value you want appears in panel **2**.

The following values of the on-board computer can be displayed:

- Total distance travelled ODO (default)
- Range RANGE
- Tripmeter 1 TRIP 1
- Tripmeter 2 TRIP 2
- Average consumption AVG in units of volume per unit of distance or in units of distance per unit of volume
- Average speed AVG in units of distance per hour

## Selecting other readings

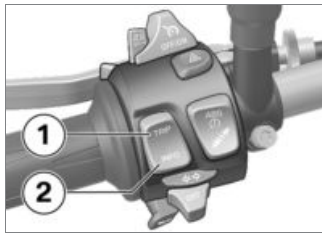

- Short-press INFO **2** to view other readings.

- Short-press TRIP **1** to return to the odometer reading ODO (default).
- Repeatedly short-press INFO **2** until the reading you want is selected.

The display readouts at your disposal are as follows:

- **LAPTIMER:** Lap times and other data can be logged here and subsequently retrieved in the RACE INFO menu.
- **RACE INFO:** The information logged with the LAPTIMER can be retrieved for viewing here. RACE INFO can be called up only when the vehicle is at a standstill.
- **SETUP MENU:** The instrument panel can be configured to suit the rider's preferences here. SETUP MENU can be called up only when the vehicle is at a standstill.
- When the display shows the LAPTIMER, long-press INFO **2**

to call up the various LAP-TIMER readings.

- When the display shows RACE INFO ENTER or SETUP MENU ENTER, long-press INFO 2 to call up the corresponding menu.

## Resetting tripmeter

- Switch on the ignition.

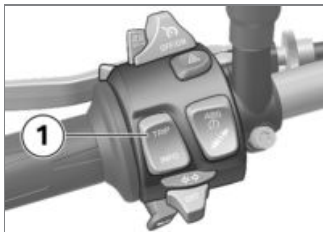

- Repeatedly short-press TRIP 1 until the tripmeter you want appears on the display.
  - » TRIP 1 or TRIP 2 appears on the display.

- Press and hold down TRIP 1 until the tripmeter reading is reset.
  - » Tripmeter reading = 0 . 0

## Resetting the average values

- Switch on the ignition.



- Repeatedly short-press TRIP 1 until the average you want to reset appears on the display.
  - » AVG appears on the display.
- Press and hold down TRIP 1 until the value you selected has reset.

» Average value = 0 . 0

## Anti-theft alarm

- with alarm system (DWA)<sup>OE</sup>

### DWA Activating

- Switching on ignition (➡ 38).
- DWA adjusting (➡ 51).
- Switch off the ignition.
- » DWA If the alarm system (DWA) is activated, then the alarm system will be armed automatically when the ignition is switched off.
- » Activation takes approximately 30 seconds to complete.
- Turn indicators flash twice.
- Confirmation tone sounds twice (if programmed).
- » Anti-theft alarm (DWA) is active.

### Alarm signal

A DWA alarm can be triggered by:

- motion sensor
- an attempt to use an unauthorised vehicle key to switch on the ignition
- disconnection of the DWA anti-theft alarm from the motorcycle's battery (DWA internal battery in the anti-theft alarm provides power - alarm tone only, the turn indicators do not flash).

All functions are sustained even if the internal battery of the DWA anti-theft alarm system is flat; the only difference is that an alarm cannot be triggered if the system is disconnected from the motorcycle's battery.

The alarm signal continues for approx. 26 seconds. While a DWA alarm is in progress an alarm tone sounds and the turn indicators flash. The type of

alarm tone can be set by an authorised BMW Motorrad dealer.

If a DWA alarm was triggered while the motorcycle was unattended, the rider is notified accordingly by an alarm tone sounding once when the ignition is switched on. The DWA LED then indicates the reason for the alarm for one minute.

### Light signals issued by the DWA LED

- Flashes 1x: Motion sensor 1
- Flashes 2x: Motion sensor 2
- Flashes 3x: Ignition switched on with unauthorised vehicle key
- Flashes 4x: Disconnection of the DWA anti-theft alarm from the motorcycle's battery
- Flashes 5x: Motion sensor 3

### DWA Deactivating

- Switching on ignition (➡ 38).
- » Turn indicators flash once.

- » Confirmation tone sounds once (if programmed).
- » Anti-theft alarm (DWA) is deactivated.

## DWA adjusting

- Switching on ignition (➡ 38).



- Repeatedly short-press INFO **1** until SETUP MENU ENTER appears on the display.
- Long-press INFO **1** to exit SETUP MENU.



- Repeatedly short-press INFO **1** until SETUP EQUIPMENT ENTER appears on the display.
- Long-press INFO **1** to exit SETUP EQUIPMENT.



- Repeatedly short-press INFO **1** until the SETUP EQIP : DWA menu item appears on the display.
    - » AUTO appears in display line **2**.
    - » The preset ON/OFF value appears in display line **3**.
  - Long-press INFO **1** to change the preset value.
- The following settings are available:
- DWA AUTO ON: The DWA anti-theft alarm is active and will be armed automatically

when the ignition is switched off.

- DWA AUTO OFF: The DWA anti-theft alarm is deactivated.

## Clock

### Setting the clock

The vehicle is at a standstill.

- Switch on the ignition.



- Repeatedly short-press INFO **2** until SETUP MENU ENTER appears on the display.
- Long-press INFO **2**.
  - » The SETUP MENU opens.
- Repeatedly short-press INFO **2** until SETUP EQUIPMENT ENTER appears on the display.
- Long-press INFO **2**.
  - » The SETUP EQUIPMENT menu opens.
- Repeatedly short-press INFO **2** until SETUP EQIP : CLOCK TIME appears on the display.
- Long-press INFO **2**.
  - » Minutes reading **4** flashes.
- Short-press TRIP **1** to step the minutes reading up.
- Short-press INFO **2** to step the minutes reading down.
- When the minutes reading is correct, long-press INFO **2**.
  - » Hours reading **3** flashes.
- Short-press TRIP **1** to step the hours reading up.
- Short-press INFO **2** to step the hours reading down.
- When the hours reading is correct, long-press INFO **2**.

- » The hours reading stops flashing.
- » This completes the process.

## Automatic Stability Control

### ASC Switching off

- Switch on the ignition.

#### NOTICE

You have the option of deactivating the ASC function while the motorcycle is on the move. ◀

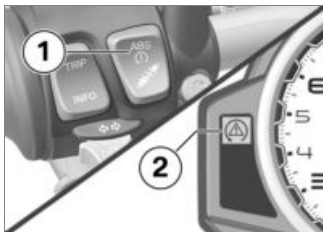

## ASC Switching on

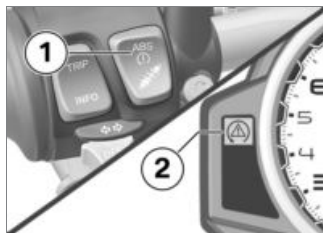

- Press and hold down button **1** until ASC telltale and warning light **2** changes status.

» The ABS setting remains unchanged.

 ASC telltale and warning light starts to show.

- Release button **1** within two seconds.

 ASC telltale and warning light remains on.

» ASC is switched off.

- Press and hold down button **1** until ASC telltale and warning light **2** changes status.

 ASC telltale and warning light goes out; if self-diagnosis has not completed it starts flashing.

- Release button **1** within two seconds.

 ASC telltale and warning light remains off or continues to flash.

» ASC is switched on.

- You also have the option of switching the ignition off and then on again.

 An ASC fault has occurred if the ASC telltale and warning light shows when the motorcycle accelerates to a speed in excess of the minimum stated below after the ignition was switched off and then on again.

min 10 km/h

## Dynamic Traction Control

– with Dynamic Traction Control (DTC)<sup>OE</sup>

## DTC Switching off

- Switch on the ignition.

## NOTICE

You have the option of deactivating the DTC function while the motorcycle is on the move. ◀



- Press and hold down button **1** until DTC telltale light **2** changes status.

 DTC telltale light starts to show.

- Release button **1** within two seconds.

 DTC telltale light remains on.

» DTC is switched off.

## DTC Switching on

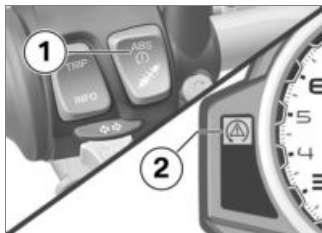

- Press and hold down button **1** until DTC telltale light **2** changes status.

 DTC telltale light goes out; if self-diagnosis has not completed it starts flashing.

- Release button **1** within two seconds.

 DTC telltale light remains off or continues to flash.

» DTC is switched on.

- If the coding plug is not inserted, you have the alternative of

switching the ignition off and then on again.

 A DTC fault has occurred if the DTC telltale light shows when the motorcycle accelerates to a speed in excess of the minimum stated below after the ignition was switched off and then on again.

min 10 km/h

## Anti-lock brake system

### ABS Switching off

- Switch on the ignition.

## NOTICE

You have the option of deactivating the ABS function while the motorcycle is on the move. ◀





- with ABS Pro<sup>OE</sup>
- » ABS Pro is switched off.<

### ABS Switching on

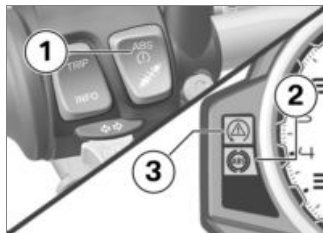

- Press and hold down button **1** until first ASC/DTC-telltale light **3** and then ABS telltale and warning light **2** change status.
- » The ASC / DTC setting remains unchanged.

 ABS telltale and warning light shows.

- Release button **1** within two seconds.

 ABS telltale and warning light remains on.

- » ABS is switched off.

- Press and hold down button **1** until first ASC/DTC telltale light **3** and then ABS telltale and warning light **2** change status.
- » The ASC / DTC setting remains unchanged.

 ABS telltale and warning light goes out; if self-diagnosis has not completed it starts flashing.

- If the coding plug is not inserted, you have the alternative of

switching the ignition off and then on again.

 An ABS fault has occurred if the ABS telltale and warning light shows when the motorcycle accelerates to a speed in excess of the minimum stated below after the ignition was switched off and then on again.

min 10 km/h

### Electronic Suspension Adjustment

– with Dynamic ESA<sup>OE</sup>

#### Adjusting the chassis and suspension

- Switching on ignition (☛ 38). In the multifunction display the spring preload is shown in area **1** and the damping in area **2**.



– with Pro riding modes<sup>OE</sup>

The following predefined scenarios are available:

- Dynamic riding on a dry road surface.
- Sporty, one-up riding on a dry road surface.

The interplay of engine torque, throttle response, ABS control and ASC or DTC control is optimised for each of these 4 scenarios.

– with Dynamic ESA<sup>OE</sup>

The suspension's damping characteristic always initially returns to the basic setting whenever riding modes are changed. The ROAD and DYNAMIC variants can then be selected.

## Setting riding mode

- Switching on ignition (▣▣▣ 38).



- Press button 1.



See the section entitled "Engineering details" for more information on the various ride modes that can be selected. ◀

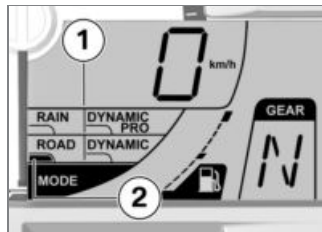

Riding modes 1 are shown. The highlight 2 tells you which riding mode is currently selected.



- Repeatedly press button 1 until the riding mode you want is highlighted.

The following ride modes can be selected:

- RAIN: For riding on a rain-wet road surface.
- ROAD: For riding on a dry road surface.

– with Pro riding modes<sup>OE</sup>

» The following riding modes are additionally available for selection:

- DYNAMIC: For dynamic riding on a dry road surface.
- DYNAMIC PRO: For sporty riding (only with coding plug installed).◀

» With the motorcycle at a standstill, the selected mode is activated after approximately two seconds.

» The newly selected riding mode is activated as you ride only when the following preconditions are satisfied:

- The throttle twistgrip is in the idle position.

- The brake levers are in the released positions.
- » The mode selected in this way is retained with the engine-characteristic, ABS, ASC/DTC and Dynamic ESA adaptation settings even after the ignition has been switched off.

### Installing coding plug

- with Pro riding modes<sup>OE</sup>



#### WARNING

**Increased engine power available in all riding modes with coding plug inserted, vehicles with power reduction.**

Risk of accident

- It is important for the rider intending to use these more sporty ride modes to familiarise himself/herself with their characteristics.

- Do not use the coding plug for riding on public roads.◀
- Switching off ignition (▶▶▶ 39).
- Removing seat (▶▶▶ 62).

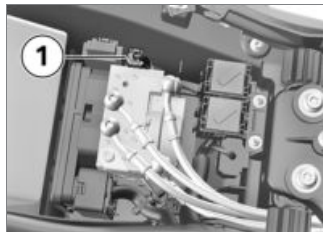

- Disconnect plug **1** from the rear carrier.

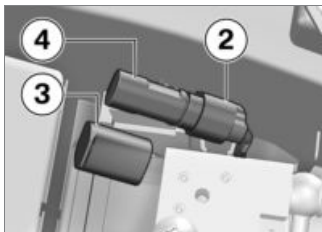

## ATTENTION

### Dirt and damp penetrating inside open connectors.

#### Malfunctions

- Reinstall the cap after removing the coding plug. ◀
- Press in latch **2** and remove cap **3**.
- Insert coding plug **4**.
- Position plug **1** in the rear carrier.
- Switch on the ignition.
  - » For safety reasons, the RAIN riding mode is activated by de-

fault when the coding plug is inserted.

- Setting riding mode (▶▶▶ 57).
  - » The preset riding mode is retained in memory, even after the ignition is switched off.
- Installing seat (▶▶▶ 63).

## Cruise-control system

– with cruise control<sup>OE</sup>

### Switching on cruise control

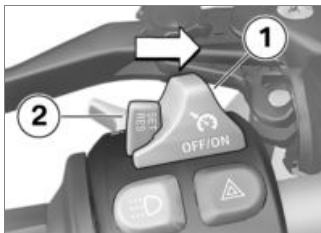

- Slide switch **1** to the right.
  - » Button **2** is enabled for operation.

## Saving road speed

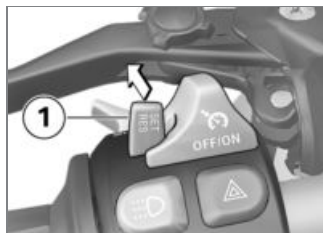

- Briefly push button **1** forward.

 Adjustment range for cruise control

20...210 km/h

 Telltale light for cruise control lights up.

- » The motorcycle maintains your current cruising speed and the setting is saved.

## Accelerating



- Briefly push button **1** forward.
  - » Speed is increased by approx. 2 km/h (1.2 mph) each time you push the button.
- Push button **1** forward and hold it in this position.
  - » The motorcycle accelerates steplessly.
  - » The current speed is maintained and saved if button **1** is not pushed again.

## Decelerating



- Briefly push button **1** back.
  - » Speed is reduced by approx. 2 km/h (1.2 mph) each time you push the button.
- Push button **1** back and hold it in this position.
  - » The motorcycle decelerates steplessly.
  - » The current speed is maintained and saved if button **1** is not pushed again.

## Deactivating cruise control

- Brake, pull the clutch lever or turn the throttle twistgrip (close the throttle by turning the twistgrip back past the idle position) to deactivate the cruise-control system.



### NOTICE

For safety reasons, cruise control is deactivated automatically when the ASC and DTC systems intervene.◀

– with Pro shift assistant<sup>OE</sup>

- Shift to deactivate the cruise-control system.



### NOTICE

Whenever the Pro shift assistant shifts gears, cruise control is automatically disengaged for safety reasons.◀

- » Telltale light for cruise control goes out.

## Resuming former cruising speed



- Briefly push button **1** back to return to the speed saved beforehand.

### NOTICE

Opening the throttle does not deactivate the cruise-control system. If you release the twistgrip the motorcycle will decelerate only to the cruising speed saved in memory, even though you

might have intended slowing to a lower speed.◀



Telltale light for cruise control lights up.

## Switching off cruise control



- Slide switch **1** to the left.
  - » The system is deactivated.
  - » Button **2** is disabled.

## Heated handlebar grips

– with heated handlebar grips<sup>OE</sup>

## Operating the heated handlebar grips

- Start the engine.



### NOTICE

The heating in the heated handlebar grips can be activated only when the engine is running.◀



### NOTICE

The increase in power consumption caused by having the heated handlebar grips switched on can drain the battery if you are riding at low engine speeds. If the charge level is low, the heated handlebar grips are switched off to ensure the battery's starting capability.◀

## NOTICE

The heated grips are switched off automatically if they start to overheat. ◀



- Press button **1**.

## NOTICE

The handlebar grips have two-stage heating. Stage two is for heating the grips quickly: it is advisable to switch to stage one as soon as the grips are warm. ◀

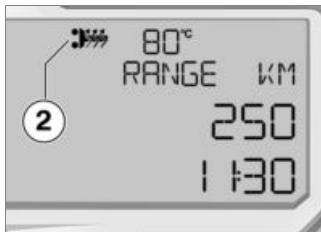

The symbol for the second heating stage **2** appears on the display.



Second stage: 100 % heating power

» The selected heating stage will be saved if you allow a certain length of time to pass without making further changes.

- Press button **1** again.
- » The symbol for the first heating stage appears on the display.



First stage: Approx. 50 % heating power

- Press button **1** again.
- » The symbol for heating stages disappears.
- » The heating is off.

## Seat

### Removing seat

- Make sure the ground is level and firm and place the motorcycle on its stand.

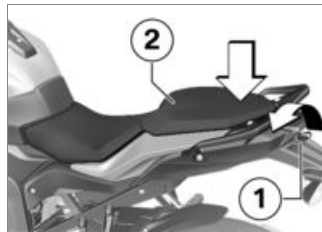

- Press down on the rear part of seat **2** to relieve the strain on the lock and at the same time unlock the seat lock by



turning vehicle key **1** counter-clockwise.

- Lift the seat at the rear and remove.
- Lay the seat on a clean surface.

## Installing seat

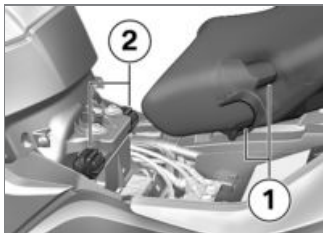

- Position the seat with mounts **1** in buffers **2** on left and right.
- Lower the rear of the seat and engage the seat in the latching mechanism.

## SETUP MENU

### Overview, SETUP MENU

- 1 Selecting submenu (INFO → 65).
  - 2 SETUP EQUIPMENT (INFO → 65)  
Call up submenu.
  - 3 – with Dynamic Traction Control (DTC)<sup>OE</sup>  
SETUP RACETRACK (INFO → 66)  
Call up submenu.
  - 4 Exit SETUP MENU  
Exiting SETUP mode (INFO → 67).
- Solid line means: short-press the TRIP/INFO rocker switch.
  - - Broken line means: long-press the TRIP/INFO rocker switch.

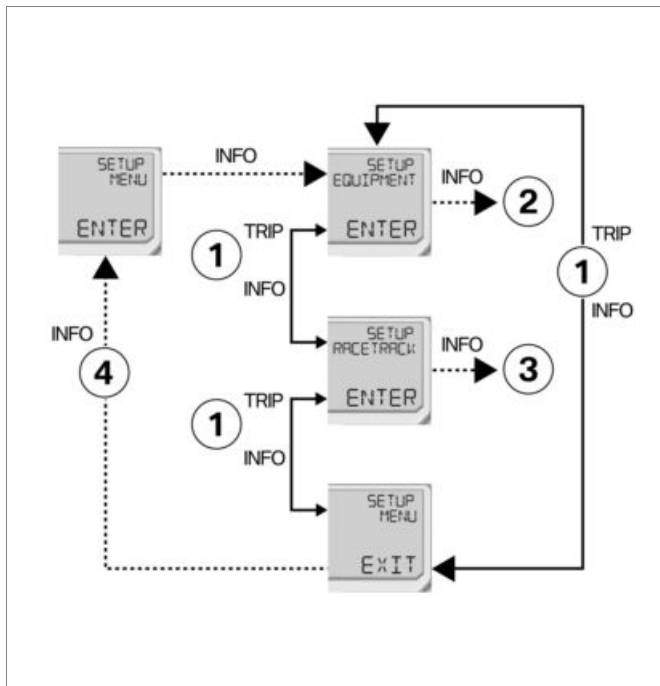

## Selecting submenu

The motorcycle is at a standstill. The on-board computer readings appear on the display.

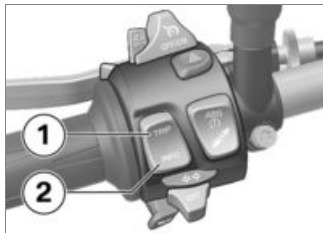

- Repeatedly short-press INFO **2** until SETUP MENU ENTER appears on the display.

### NOTICE

If you scroll down too far, repeatedly short-press INFO **2** until the menu returns to the start and then to the reading you want. ◀

- Long-press INFO **2**.

- » SETUP EQUIPMENT ENTER appears as the first submenu.
  - Repeatedly short-press TRIP **1** or INFO **2** until the submenu you want appears on the display.
  - Long-press INFO **2** to call up the submenu you want.
- Each time INFO **2** is pressed the possible parameters are shown in the sequence described below; each time TRIP **1** is pressed they are shown in reverse sequence.

## SETUP EQUIPMENT

- with alarm system (DWA)<sup>OE</sup>
- Automatically activate anti-theft alarm function when the ignition is switched off DWA AUTO ON or leave the automatic function switched off DWA AUTO OFF. ◀
- Set the time CLOCK TIME.
- Adjust display brightness DISP BRIGHT.
- Switch-on speed for gearshift light GSL ON-RPM (Gear Shift Light)
- Switch-off speed for gearshift light GSL OFF-RPM
- Gearshift-light brightness GSL BRIGHT
- Gearshift light flash frequency GSL FREQ
- with daytime running light<sup>OE</sup>
- Activate automatic daytime riding light DRL AUTO ON or manual daytime riding light DRL AUTO OFF. ◀
- with preparation for navigation system<sup>OE</sup>
- with navigation system<sup>OA</sup>
- Show time from global positioning system GPS TIME ON or time from on-board computer GPS TIME OFF. ◀
- Open the submenu for changing units of measure

for speed, odometer reading, range, temperature, average consumption and time SETUP EQIP:UNITS ENTER.<

## SETUP EQIP:UNITS

- Change unit of measure for speed: UNIT SPEED KM/H or UNIT SPEED MPH
- Change unit of measure for odometer: UNIT ODO KM or UNIT ODO MLS
- Change unit of measure for temperature: UNIT TEMP DEG: C or UNIT TEMP DEG: F
- Change unit of measure for average consumption: UNIT CONS L/100, UNIT CONS MPG: US, UNIT CONS MPG: UK or UNIT CONS KM/L
- Set 24-hour or 12-hour mode for clock: UNIT CLOCK 24 or UNIT CLOCK 12

## SETUP RACETRACK

- with Dynamic Traction Control (DTC)<sup>OE</sup>
- Set LAPTIMER readings: Current lap LAPTMRUN, time required for preceding lap LAPTMLAST, best lap LAPTMBEST, total of all lap times and lap distances logged in memory LAPTMTOTAL, best-ever lap LAPTMBEST-EVER<
- with Dynamic Traction Control (DTC)<sup>OE</sup>
- Display-freeze period for the most recent lap time LAPTMHOLD<
- with Dynamic Traction Control (DTC)<sup>OE</sup>
- Debounce time (waiting time before a new lap can be started) of the headlight-flasher button for LAPTIMER LAPTMDEB-TM in seconds.<

- with Dynamic Traction Control (DTC)<sup>OE</sup>
- Change the headlight-flasher button to trigger lap timing. LAPTMRIGAUTO: Trigger by headlight-flasher button or infrared receiver; LAPTMRIGMANUAL: Trigger by headlight-flasher button only; LAPTMRIGEXTERN: Trigger by infrared receiver only.<

## Setting parameters

Parameter appears on the display.

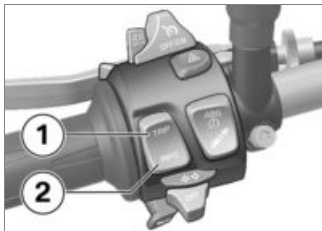

## Exiting SETUP mode

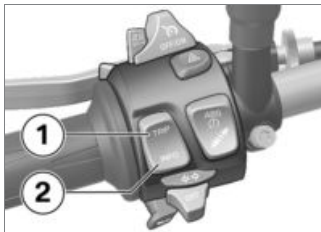

- Press and hold down **INFO 2** until the parameter starts to flash.
- Repeatedly short-press **TRIP 1** or **INFO 2** until the value you want appears on the display.

When the value you want is shown:

- Press and hold down **INFO 2** until the value stops flashing.
- » The value is saved.

- Press and hold down **TRIP 1** until the multifunction display switches to the default display mode.
- » A value that is still flashing will be saved.
- Alternatively: Repeatedly press **TRIP 1** or **INFO 2** until **SETUP ... EXIT** appears in the submenu.
- Long-press **INFO 2** to exit the submenu.
- » **SETUP ... ENTER** appears on the display.

- Repeatedly press **TRIP 1** or **INFO 2** until **SETUP MENU EXIT** appears on the display.
- Long-press **INFO 2** to exit the **SETUP MENU**.
- » **SETUP MENU ENTER** appears on the display.

## SETUP EQUIPMENT

### Display brightness



You can set display brightness to any of five levels.

#### Range of values

- 1, 2, 3, 4, 5
- Factory setting: 5

### Engine speed for gearshift light ON



Switch-on rpm setting for the gearshift light.

#### Range of values

- 7000, 8000, 9000, 9500, 10000, 10500, 11000
- Factory setting: 7000
- You can select only engine speeds that are lower than the gearshift light OFF speed.

### Engine speed for gearshift light OFF



Switch-off rpm setting for the gearshift light.

#### Range of values

- 8000, 9000, 9500, 10000, 10500, 11000, 13500
- Factory setting: 13500
- You can select only engine speeds that are higher than the gearshift light ON speed.

## Shift-light brightness



Setting for gearshift-light brightness as a percentage of maximum brightness.

The gearshift light remains on while brightness is being adjusted and immediately adjusts to the selected brightness setting.

### Range of values

- 20, 30, 40, ... 100
- Factory setting: 100

## Shift-light flash frequency



Setting for the frequency at which the gearshift light flashes, shown in Hz (1/s).

### Range of values

- ON, 4, 8
- Factory setting: 4
- If you select ON the gearshift light comes on and stays lit without flashing.
- The gearshift light slow-flashes if you select 4.
- The gearshift light quick-flashes if you select 8.

## Automatic daytime riding light

- with daytime running light<sup>OE</sup>



You can switch the automatic function for the daytime riding light on or off.

### Range of values

- OFF, ON
- Factory setting: OFF

### GPS time

- with preparation for navigation system<sup>OE</sup>
- with navigation system<sup>OA</sup>



Select time: You can set this function to show either the time from the global positioning system or the time from the on-board computer.

**Range of values**

- OFF, ON
- Factory setting: OFF



# LAPTIMER

## Multifunction display

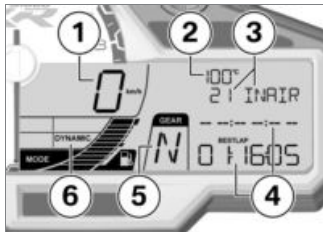

- 1 Speed
- 2 Coolant temperature
- 3 Intake-air temperature

- 4 LAPTIMER  
The readings in these lines can be changed by the rider.

Individualise the LAPTIMER (► 73).  
LAPTIMER display layout (► 82)

As shown:

LASTLAP: The time for the preceding lap

BESTLAP: The fastest of the laps currently logged in memory

- 5 Gear indicator
- 6 Riding mode (► 56)

### Labels for the values shown on the display

The following times can be displayed in the third line:

- Time for the preceding lap, labelled "LASTLAP"
- Running time for the current lap

The following times can be displayed in the fourth line:

- Fastest lap saved, labelled "BESTLAP"
- All-time best lap, no label
- Running time for the current lap

The possible combinations are described on page (► 82).

At the start of each new lap the time for the preceding lap is shown briefly before the display switches to the running time of the current lap. The length of this freeze period can be set as described on page (► 84).

## Overview, LAPTIMER

- 1 Pause/resume timing. (☛ 74)
  - 2 Starting timing (☛ 73).
  - 3 Individualise the LAPTIMER (☛ 73).
- Solid line means: short-press the TRIP/INFO rocker switch.
  - - Broken line means: long-press the TRIP/INFO rocker switch.

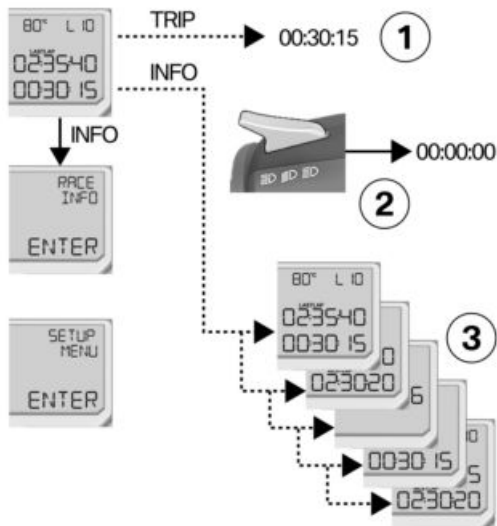

## Individualising LAPTIMER

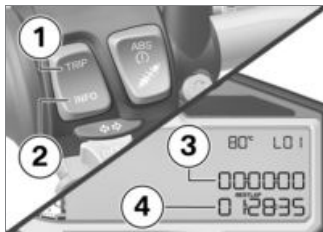

- Activating default reading (►► 81).
  - » The odometer reading (ODO) appears on the display.
- Short-press INFO **2**.
  - » The LAPTIMER is called up and shows in the factory settings RUN **3** and BESTLAP **4**.
- If you want to change the content of lines **3** and **4** in the LAPTIMER, repeatedly long-press INFO **2** until lines **3** and **4** show the readings you want.

- » Your chosen LAPTIMER display layout is accepted and saved in memory.
- » LAPTIMER display layout (►► 82)

## Starting timing

The LAPTIMER is called up.



- Press button **1** to start timing.

### NOTICE

The engine has to be running and the vehicle moving in order for the headlight-flasher signal to be detected.◀

- » Timing RUN **2** is running.
- Every time you cross the start/finish line, press button **1** again to start timing for the next lap.
  - » The data of the preceding lap are written into memory.
  - » RUN **2** starts again at 00:00:00.
  - » Timing continues even if you exit the display mode. In the other modes, however, timing of another lap can be started only by an external signal.

## Infrared receiver

An infrared signal provides a convenient way of operating the LAPTIMER. In these circumstances, note the following:

- The infrared receiver available as an optional accessory has to be connected to the plug for optional accessories located underneath the right side panel (►► 179).

- In SETUP RACETRACK, the LAPTIMER trigger mode has to be set to LAPTMR TRIG AUTO or LAPTMR TRIG EXTERN (▶▶ 84).

The headlight flasher button can be used to operate the instrument panel even when the infrared receiver is installed. To do so you must have the LAPTIMER trigger mode set to LAPTMR TRIG AUTO or LAPTMR TRIG MANUAL.

A lap timeout can be defined to stop the receiver from registering completion of a lap prematurely in response to spurious signals (▶▶ 84). Signals received before this time elapses are ignored.

## Interrupting timing

Timing is running.

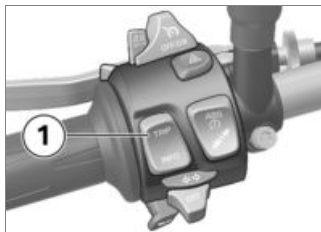

- Long-press TRIP **1** to interrupt timing.
- Long-press TRIP **1** again to resume timing.

## Ending timing

Timing is running.

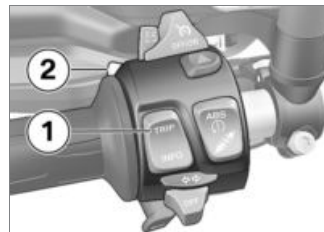

- Long-press TRIP **1** to pause timing.
- Short-press button **2**.
  - » The time shown on the display is deleted: -- : -- : -- .
  - Timing is ended.
  - No lap time is saved in memory.
- Short-press TRIP **1** to exit the lap timer.



## NOTICE

If more laps are subsequently timed, lap numbering resumes. Numbering is not restarted at lap 1 unless you delete the

current timing session in the  
RACE INFO display mode.◀

» ODO appears on the display.

## RACE INFO

### RACE INFO part 1

- 1 Delete the all-time best lap.
  - 2 Information about the current best lap  
Succession of three status indicators  
Information for a lap (▬▬▬▬ 78)
  - 3 Delete current best lap.
  - 4 Information about last lap
  - 5 Delete last lap.
  - 6 Information about other laps  
Selecting saved lap (▬▬▬▬ 78).  
Delete the lap (▬▬▬▬ 79).
- Solid line means: short-press the TRIP/INFO rocker switch.
- Broken line means: long-press the TRIP/INFO rocker switch.

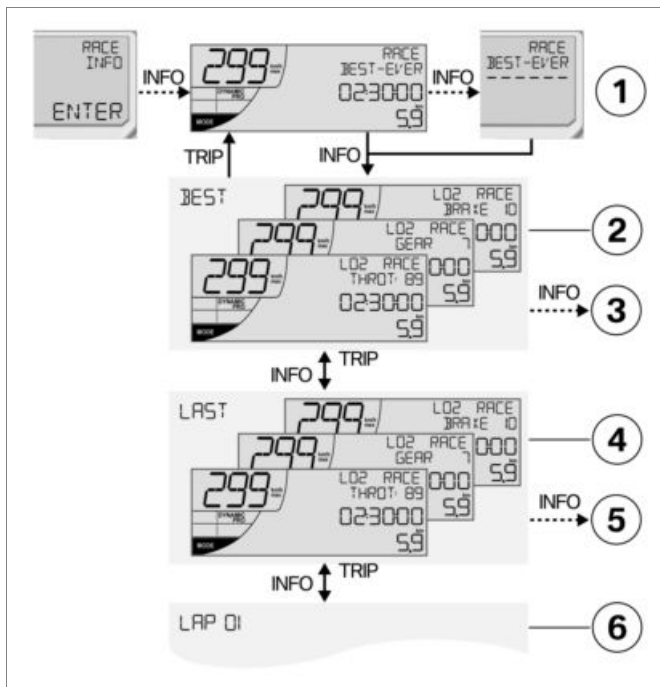

## RACE INFO part 2

- 1 Information about lap 01  
Selecting saved lap (⇨ 78).

Information for a lap (⇨ 78)

- 2 Delete the lap (⇨ 79).
- 3 Information about lap 02
- 4 Total of all lap times and distances

- 5 Clearing all saved data (⇨ 79).

- 6 Delete the all-time best lap.

- 7 Exit the RACE INFO (⇨ 80).

Activating default reading (⇨ 81).

- Solid line means: short-press the TRIP/INFO rocker switch.
- Broken line means: long-press the TRIP/INFO rocker switch.

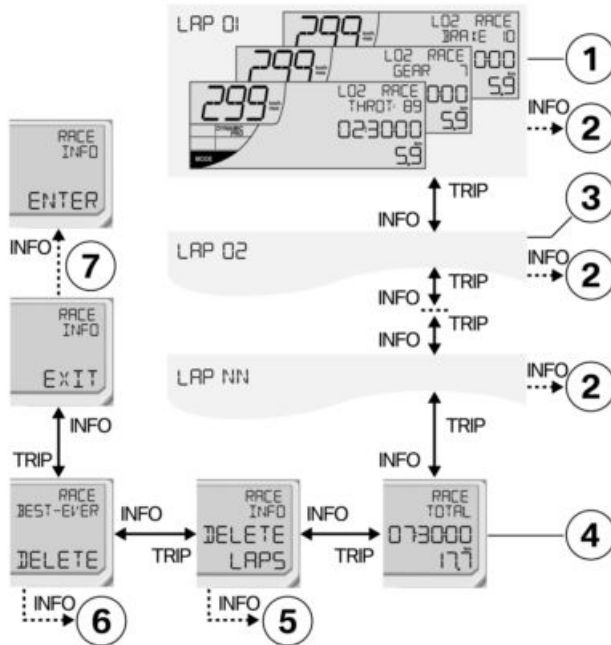

## Selecting saved lap

The motorcycle is at a standstill. RACE INFO appears on the display.

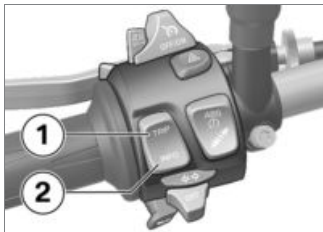

- Short-press TRIP **1** or INFO **2** to step through the laps stored in memory one by one.



### NOTICE

If you pull away from rest in this mode the electronics switch automatically to the LAPTIMER function.◀

Each time INFO **2** is pressed the laps logged in memory and the

functions are shown in the sequence described below; each time TRIP **1** is pressed they are shown in reverse sequence:

- Best-ever lap BEST-EVER
- Best lap logged in memory BEST
- Last lap logged in memory LAST
- All other laps logged in memory LAP 01 ... LAP 60
- Aggregate time and distance for all laps logged in memory TOTAL
- Delete lap data logged in memory DELETE LAPS.
- Delete the best-ever lap logged in memory BEST-EVER DELETE.
- Exit RACE INFO RACE INFO EXIT.

## Information for a lap

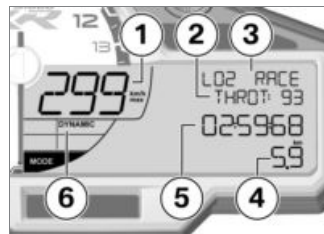

- 1** In sequence: Top speed (max), average speed (Ø) and lowest speed (min) on the lap currently displayed.
- 2** In sequence: Average throttle twistgrip position (THROT) in percent, percentage of lap ridden with brakes applied (BRAKE) and number of gearshifts (GEAR) on the lap currently displayed.
- 3** Lap for which the data on the display apply.
- 4** Distance ridden.



- 5 Time for the lap currently displayed.
- 6 The riding mode most commonly used is displayed continuously.

## Clearing all saved data

RACE INFO appears on the display.

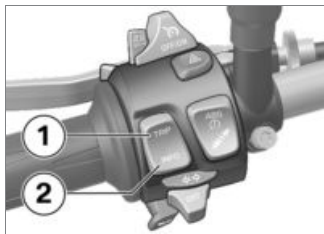

- Repeatedly short-press TRIP **1** or INFO **2** until DELETE LAPS appears on the display.
- Long-press INFO **2** to delete all the logged data from memory.

- » BEST-EVER DELETE appears on the display.
- Either short-press INFO **2** to skip deleting the best-ever lap time.
- Or long-press INFO **2** to delete the data for the best-ever lap time.
- » BEST-EVER is deleted:  
--:--:--
- » RACE INFO EXIT appears on the display.

## All-time best lap

The all-time best lap (BEST-EVER) is the fastest of all timed laps and is updated as soon as a faster lap is timed.

The best-ever lap remains stored in memory even if the timed laps are deleted. This means that other races can subsequently be timed and the lap times of those races compared with the best-ever lap from earlier races.

The best-ever lap can also be deleted from memory. If the best-ever lap is from a race timed in the past, it is accompanied on the display by the appropriate lap number. If the best-ever lap shows without a lap number, this lack of a lap number indicates that the time is from a race timed in the past but subsequently deleted from memory.

## Delete the lap

RACE INFO appears on the display.

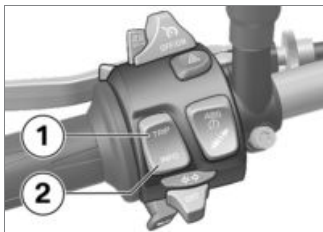

- Repeatedly short-press **TRIP 1** or **INFO 2** until the lap you want to delete appears on the display.
- Long-press **INFO 2** to delete the lap.
- » When a logged lap has been deleted from memory it is superseded as follows:
  - **BEST**: The lap that was the second-best time until the best time was deleted becomes the new best lap.
  - **LAST**: The lap that was the preceding lap until the lap was

deleted becomes the new last lap.

- » When a random lap has been deleted the following is taken into account:
  - Total time is reduced by the time for the lap you deleted.
  - Total distance is reduced by the distance for the lap you deleted.
  - The numbering of the remaining laps remains unchanged.

## Exiting RACE INFO

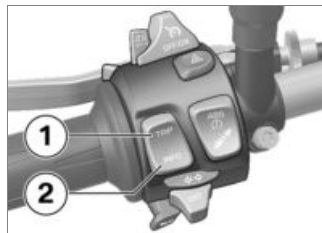

- Repeatedly short-press **TRIP 1** or **INFO 2** until **RACE INFO EXIT** appears on the display.
- Long-press **INFO 2** to exit **RACE INFO**.
- » The readings already recorded remain saved in memory.

## Activating default reading

» ODO appears on the display.

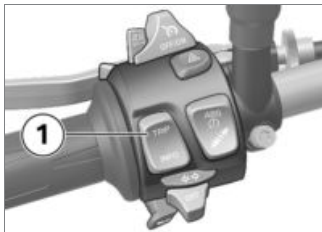

- Long-press TRIP 1.



### NOTICE

Regardless of what is shown on the multifunction display at any given time, long-pressing TRIP 1 always calls up the default layout with the odometer reading (ODO).

The only exception is the following:

LAPTIMER with timing in progress/paused: Long-pressing TRIP 1 pauses or resumes timing, as applicable.◀

## SETUP RACETRACK LAPTIMER display layout

There is a choice of six LAP-TIMER display layouts.

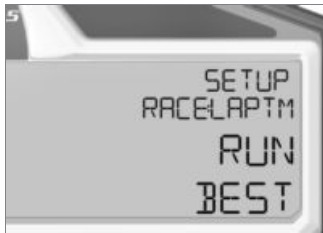

### Layout 1 (factory setting)

Line 3 shows the running time for the current lap, the best lap currently logged in memory is shown in line 4.



### Version 2

Line 3 shows the time recorded for the preceding lap, the running time for the current lap is shown in line 4.



### Version 3

Line 3 shows the time needed for the preceding lap, the best lap currently logged in memory is shown in line 4.



#### Version 4

Line 3 shows the running time for the current lap, the total time for all the laps currently logged in memory is shown in line 4.



#### Version 5

Line 3 shows the running time for the current lap, the all-time best lap (||||▶ 79) is shown in line 4.



#### Version 6

Line 3 is blank, line 4 shows the running time for the current lap.

## Display-freeze period for the most recent time



Setting for HOLD time in seconds.

After the start of a new lap the time for the preceding lap remains visible for this preset HOLD time. When this hold time expires the readout switches back to the running time for the current lap.

### Range of values

- OFF, 5, 10, 15, ... 30
- Factory setting: 5

## Debounce time for starting each new lap



You can set the minimum time that must elapse from when the first signal is received until a second signal will be accepted.

- Within this debounce time the headlight flasher can be used without it triggering the signal for a new lap.
- When an infrared receiver is being used this prevents the signals from two or more transmitters in close proximity from being accepted for processing.

## Range of values

- OFF, 10, 30, 45, 60
- Factory setting: 10

## LAPTIMER trigger mode



There are the various options for starting lap timing.

### Range of values

- AUTO, EXTERN, MANUAL
- Factory setting: AUTO
- AUTO: Pressing the headlight flasher button and a signal from the lap trigger are both accepted as the trigger source.

- EXTERN: Only a signal from the lap trigger is accepted as the trigger source.
- MANUAL: Only pressing the headlight flasher button is accepted as the trigger source.





## **Adjustment**

Windscreen .....	88
Mirrors .....	88
Headlight .....	89
Brakes .....	90
Spring preload .....	90
Damping .....	92

## Windscreen

### Adjusting windscreen

The motorcycle is at a standstill.



### WARNING

#### Adjusting the windscreen while riding.

Risk of falling

- Do not attempt to adjust the windscreen unless the motorcycle is at a standstill. ◀
- Move the windscreen up or down. Take care not to scratch the windscreen when adjusting.

» The windscreen is held at the top or bottom limit position by spring force.

## Mirrors

### Adjusting mirrors



- Turn the mirror to the desired position.

### Adjusting mirror arm

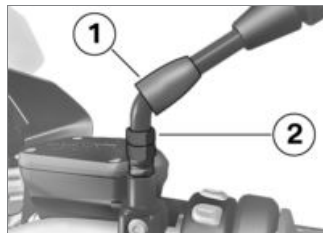

- Push protective cap **1** for the threaded fastener up on the mirror arm.
- Slacken locknut **2**.
- Turn the mirror arm to the appropriate position.
- Tighten the locknut to the specified tightening torque, while holding the mirror arm to ensure that it does not move out of position.



Mirror (lock nut) to adapter

22 Nm

- Push protective cap **1** over the threaded fastener.

## Headlight

### Adjusting headlight for driving on left/driving on right

This motorcycle has a symmetric-beam low-beam headlight. If the motorcycle is ridden in a country where the opposite rule of the road applies, its symmetric low-beam headlight means that no measures are necessary to prevent the headlight beam from dazzling oncoming traffic.

### Headlight beam throw and spring preload

Headlight beam throw is generally kept constant when spring preload is adjusted to suit load. Headlight beam throw is set correctly ex-works.

#### NOTICE

If there are doubts about the correct headlight beam throw, have the setting checked by a specialist workshop, preferably an authorised BMW Motorrad dealer. ◀

### Adjusting headlight beam throw

- Disengage the inner trim panel (►► 155).



If, for a high load, the adjustment of the spring pre-load is no longer sufficient not to dazzle oncoming traffic:

- Turn adjusting screw **1** counter-clockwise with open-ended spanner **2** (on-board toolkit) to lower the headlight beam.
- Installing inboard cover (►► 156).

When the motorcycle is again ridden with a lower load:

- Return the headlight to its basic setting.

## Brakes

### Adjusting brake lever

#### **! WARNING**

#### Changed position of the brake fluid reservoir.

Air in the brake system.

- Do not turn the handlebars or the handlebar fitting on the handlebar. ◀

#### **! WARNING**

#### Adjusting the brake lever while riding.

Risk of accident

- Do not attempt to adjust the brake lever unless the motor-cycle is at a standstill. ◀

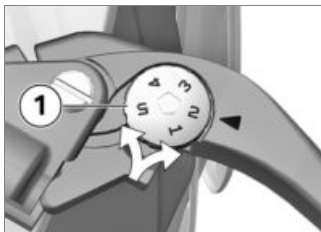

- Applying light pressure from behind, turn adjusting screw **1** to the desired position.



#### **NOTICE**

The adjusting screw is easier to turn if you push the brake lever forward. ◀

- » Adjustment options:
- from position 1: largest span between handlebar grip and brake lever
  - to position 5: smallest span between handlebar grip and brake lever

## Spring preload

– without Dynamic ESA<sup>OE</sup>

### Adjustment

Spring preload has to be adjusted to suit the weight of rider, passenger and luggage. Increase spring preload for heavier loads, decrease spring preload for lighter loads.

#### **! WARNING**

#### Spring preload setting and spring-strut damping setting not matched.

Impaired handling.

- Adjust spring-strut damping to suit spring preload. ◀

### Adjusting spring preload for rear wheel

- Make sure the ground is level and firm and place the motor-cycle on its stand.

- Make sure there is no load on the motorcycle; remove all items of luggage, if carried.



- Use the tool from the on-board toolkit to slacken screw **1**.

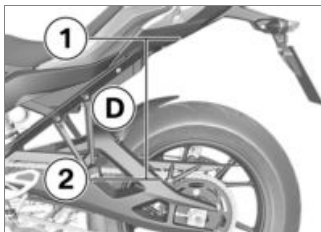

- Hold the motorcycle upright (do not prop it on the side stand) and measure distance **D** from bottom edge **1** of the rear trim panel to screw **2** of the chain guard.
- Apply the rider's weight to the motorcycle.
- With the assistance of a second person, measure distance **D** between points **1** and **2** again and calculate the difference (negative spring displacement) between the two readings.

 Load-dependent adjustment of spring preload

Suspension compression at rear wheel

10 mm (One-up riding without luggage)

16 mm (One-up with luggage)

26 mm (Two-up with luggage)

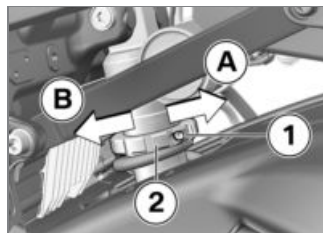

- To reduce negative spring displacement (increase spring preload, in other words), use the tool from the on-board toolkit to turn adjusting ring **2** in direction **B**.

- To increase negative spring displacement (reduce spring preload, in other words), use the tool from the on-board toolkit to turn adjusting ring **2** in direction **A**.
- Tighten screw **1** to the specified tightening torque.



Screw in adjusting ring

3 Nm

## Damping

– without Dynamic ESA<sup>OE</sup>

## Adjustment

Damping must be adapted to suit the condition of the surface on which the motorcycle is ridden and to suit spring preload.

– An uneven surface requires softer damping than a smooth surface.

– An increase in spring preload requires firmer damping, a reduction in spring preload requires softer damping.

## Adjusting compression-stage damping for front wheel



- Adjust compression-stage damping by turning adjusting screw **1** and reading the red scale on the left fork leg.



- To increase damping: Use the tool from the on-board kit to turn the adjusting screw in the appropriate direction so that mark **2** points to a higher reading on the scale.
- To reduce damping: Use the tool from the on-board kit to turn the adjusting screw in the appropriate direction so that mark **2** points to a lower reading on the scale.



Compression stage, basic setting, front

Position 1 (comfortable setting with rider 85 kg)

Position 3 (normal setting with rider 85 kg)

Position 7 (sports setting with rider 85 kg)

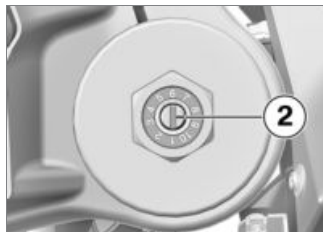

- To increase damping: Use the tool from the on-board kit to turn the adjusting screw in the appropriate direction so that mark **2** points to a higher reading on the scale.
- To reduce damping: Use the tool from the on-board kit to turn the adjusting screw in the appropriate direction so that mark **2** points to a lower reading on the scale.

## Adjust the rebound-stage damping for front wheel

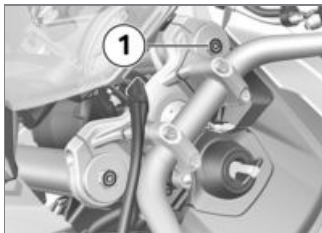

- Adjust rebound-stage damping by turning adjusting screw **1** and reading the yellow scale on the right fork leg.



Rebound stage, basic setting, front

Position 1 (comfortable setting with rider 85 kg)

Position 3 (normal setting with rider 85 kg)

Position 7 (sports setting with rider 85 kg)

## Factory default settings, front wheel

- Reset the factory defaults as stated below.



Factory default settings for compression/rebound stages, front

Position 5

## Adjusting rebound-stage damping for rear wheel

- Make sure the ground is level and firm and place the motorcycle on its stand.



- Adjust compression-stage damping by turning adjusting screw **1** and reading the yellow scale.



- To increase damping: Use the tool from the on-board kit to turn the adjusting screw in the

appropriate direction so that mark **2** points to a higher reading on the scale.

- To reduce damping: Use the tool from the on-board kit to turn the adjusting screw in the appropriate direction so that mark **2** points to a lower reading on the scale.



Rebound stage, basic setting, rear

Position 5 (One-up riding without luggage)

Position 6 (One-up with luggage)

Position 8 (Two-up with luggage)



## **Riding**

Safety instructions .....	96
Comply with checklist.....	99
Starting .....	99
Running in .....	103
Shifting gear .....	104
Brakes .....	105
Parking your motorcycle .....	108
Refuelling .....	109
Securing motorcycle for transportation .....	110

## Safety instructions

### Rider's equipment

Do not ride without the correct clothing! Always wear:

- Helmet
- Motorcycling jacket and trousers
- Gloves
- Boots

This applies even to short journeys, and to every season of the year. Your authorised BMW Motorrad dealer will be glad to advise you on the correct clothing for every purpose.

### Restricted angle of heel

A motorcycle with lowered suspension has less ground clearance and cannot corner at angles of heel as extreme as those achievable by a counterpart motorcycle with standard-height suspension.



### WARNING

**When a motorcycle with lowered suspension is cornering, certain components can come into contact with the surface at a bank angle less than that to which the rider is accustomed.**

Risk of falling

- Carefully try out the limits of the motorcycle's bank angle and adapt your style of riding accordingly.◀

Test your motorcycle's angle of heel in situations that do not involve risk. When riding over kerbs and similar obstacles, bear in mind that your motorcycle's ground clearance is limited.

Lowering the motorcycle's suspension shortens suspension travel (see the section entitled "Technical Data"). Ride comfort might be restricted as a result.

Be sure to adjust spring preload accordingly, particularly for riding two-up.

### Loading





### WARNING

**Handling adversely affected by overloading and imbalanced loads.**

Risk of falling

- Do not exceed the permissible gross weight and be sure to comply with the instructions on loading.◀
- Adjusting spring preload setting and damping to the total weight.
- with case holders left / right<sup>OE</sup>
- Ensure that the case volumes on the left and right are equal.
- Make sure that the weight is uniformly distributed between right and left.

- Pack heavy items at the bottom and toward the inboard side.
  - Note the maximum permissible payload and the speed limit for riding with cases fitted, as stated on the label inside the case (see also the section entitled "Accessories").◀
- with topcase<sup>OA</sup>
- Note the maximum permissible payload and the speed limit for riding with topcase fitted, as stated on the label inside the case (see also the section entitled "Accessories").◀
- with tank rucksack<sup>OA</sup>
- Note the maximum permissible payload and the speed limit for riding with the tank rucksack fitted.

 Payload of tank rucksack
max 5 kg
 Maximum permissible speed for riding with the tank bag fitted to the motorcycle
max 160 km/h◀

## Speed

If you ride at high speed, always bear in mind that various boundary conditions can adversely affect the handling of your motorcycle:

- Spring-strut and shock-absorber system not set up correctly
- Imbalanced load
- Loose clothing
- Insufficient tyre pressure
- Poor tyre tread
- Etc.

## Top speed



**DANGER**

### Top speed of the motorcycle higher than the permissible maximum rated speed of the tyres.

Risk of accident due to tyre damage at high speed.

- Comply with the tyre-specific speed restrictions.◀

Affix a label stating the maximum permissible speed in the rider's field of vision.

## Risk of poisoning

Exhaust fumes contain carbon monoxide, which is colourless and odourless but highly toxic.



**WARNING**

### Exhaust gases adversely affecting health.

Risk of asphyxiation

- Do not inhale exhaust fumes.

- Do not run the engine in an enclosed space.◀

## Risk of burn injury



### CAUTION

**Engine and exhaust system become very hot when the vehicle is in use.**

Risk of burn injury

- When you park the vehicle make sure that no-one and no objects can come into contact with the hot engine and exhaust system.◀

## Catalytic converter

If misfiring causes unburned fuel to enter the catalytic converter, there is a danger of overheating and damage.

For this reason, observe the following points:

- Do not run the fuel tank dry.
- Do not attempt to start or run the engine with a spark-plug cap disconnected.
- Stop the engine immediately if it misfires.
- Use only unleaded fuel.
- Comply with all specified maintenance intervals.



### ATTENTION

**Unburned fuel in catalytic converter.**

Damage to catalytic converter.

- Note the points listed for protection of the catalytic converter.◀

## Risk of overheating



### ATTENTION

**Engine running for prolonged period with vehicle at standstill.**

Overheating due to insufficient cooling. In extreme cases, the motorcycle could catch fire.

- Do not allow the engine to idle unnecessarily.
- Ride away immediately after starting the engine.◀

## Tampering



### ATTENTION

**Tampering with the motorcycle (e.g. engine management ECU, throttle valves, clutch).**

Damage to the affected parts, failure of safety-relevant functions. Damage due to tampering is not covered by the warranty.

- Do not tamper with the vehicle in any way that could result in tuned performance.◀

## Comply with checklist

- At regular intervals, use the checklist below to check your motorcycle.

### Always before riding off:

- Operation of the brake system
- Operation of the lights and signalling equipment
- Checking clutch function (▣▣▣ 136).
- Checking tyre tread depth (▣▣▣ 139).
- Cases correctly installed and luggage secured

### Every 3rd refuelling stop:

- without Dynamic ESA<sup>OE</sup>
- Adjusting spring preload for rear wheel (▣▣▣ 90).
- Adjusting rebound-stage damping for rear wheel (▣▣▣ 93).◁

– with Dynamic ESA<sup>OE</sup>

- Adjusting the chassis and suspension (▣▣▣ 55).◁
- Checking engine oil level (▣▣▣ 131).
- Checking front brake pad thickness (▣▣▣ 133).
- Check rear brake pad thickness (▣▣▣ 134).
- Checking brake-fluid level, front brakes (▣▣▣ 135).
- Checking the brake-fluid level, rear brakes (▣▣▣ 136).
- Check coolant level (▣▣▣ 137).
- Lubricating chain (▣▣▣ 163).
- Checking chain tension (▣▣▣ 163).

## Starting

### Start engine

- Switch on the ignition.
  - » Pre-Ride-Check is performed. (▣▣▣ 100)

- » ABS self-diagnosis is in progress. (▣▣▣ 101)
- » ASC self-diagnosis is in progress. (▣▣▣ 101)
- with Dynamic Traction Control (DTC)<sup>OE</sup>
  - » DTC self-diagnosis is in progress. (▣▣▣ 102)◁
- Select neutral or, if a gear is engaged, pull the clutch lever.



### NOTICE

You cannot start the motorcycle with the side stand extended and a gear engaged. The engine will switch itself off if you start it with the gearbox in neutral and then engage a gear before retracting the side stand.◀

- For a cold engine start and low temperatures: pull clutch.



- Press starter button **1**.

## NOTICE

The start attempt is automatically interrupted if battery voltage is too low. Recharge the battery before you start the engine, or use jump leads and a donor battery to start.

See the subsection on jump starting in "Maintenance" for more details. ◀

- » The engine starts.
- » Consult the troubleshooting chart below if the engine refuses to start. (▶▶ 188)

## Pre-Ride-Check

The instrument panel runs a test of the warning lights, the revolution counter and the display when the ignition is switched on: this is the Pre-Ride-Check. The test is aborted if you start the engine before it completes.

### Phase 1

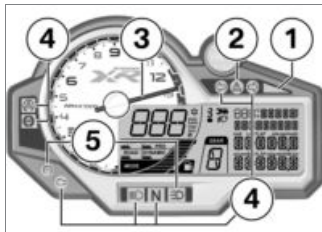

- with alarm system (DWA)<sup>OE</sup> LED **1** briefly flashes red.

"General" warning light **2** shows red.

All the segments in the display light up.

Telltale and warning lights **4** show.

- with cruise control<sup>OE</sup> Depending on the equipment configuration, telltale and warning lights **5** show.

Needle **3** of the revolution counter moves all the way to the position for maximum engine revolutions.

### Phase 2

'General' warning light **2** changes from red to yellow.

### Phase 3

The needle of the revolution counter moves to the position for zero engine revolutions. The telltale and warning lights go out or assume operational status, as applicable.

The display switches to its ordinary display mode. The on-board computer readings appear on the display.

If a warning light does not show:



### Faulty warning lights.

No indication of malfunctions.

- Check all the warning and telltale lights.◀
- Have the fault rectified as quickly as possible by a specialist workshop, preferably an authorised BMW Motorrad dealer.

### ABS self-diagnosis

BMW Motorrad Race ABS performs self-diagnosis to ensure its operability. Self-diagnosis is performed automatically when you switch on the ignition. The motorcycle has to move forward a

few metres for the wheel-speed sensors to be tested.

#### Phase 1

» Test of the diagnosis-compatible system components with the vehicle at a standstill.



ABS telltale and warning light flashes.

#### Phase 2

» Test of the wheel-speed sensors as the vehicle pulls away from rest.



ABS telltale and warning light flashes.

### ABS self-diagnosis completed

» The ABS telltale and warning light goes out.

If an indicator showing an ABS fault appears when ABS self-diagnosis completes:

- You can continue to ride. Bear in mind that the ABS and in-

tegral braking function are not available or the functionality is subject to certain restrictions.

- Have the fault rectified as quickly as possible by a specialist workshop, preferably an authorised BMW Motorrad dealer.

### ASC self-diagnosis

BMW Motorrad ASC performs self-diagnosis to ensure its operability. Self-diagnosis is performed automatically when you switch on the ignition.

#### Phase 1

» Test of the diagnosis-compatible system components with the vehicle at a standstill.



ASC telltale and warning light slow-flashes.

**Phase 2**

- » Pullaway test of the system components with diagnostic capability.



ASC telltale and warning light slow-flashes.

**ASC self-diagnosis completed**

- » The ASC symbol no longer shows.
- Check all the warning and telltale lights.



ASC self-diagnosis not completed

The ASC function is not available, because self-diagnosis did not complete. (The motorcycle has to reach a defined minimum speed with the engine running for the wheel-speed sensors to be checked: min 5 km/h)

If an indicator showing an ASC fault appears when ASC self-diagnosis completes:

- You can continue to ride. Bear in mind that the ASC is not available.
- Have the fault rectified as quickly as possible by a specialist workshop, preferably an authorised BMW Motorrad dealer.

**DTC self-diagnosis**

– with Dynamic Traction Control (DTC)<sup>OE</sup>

BMW Motorrad DTC performs self-diagnosis to ensure its operability. Self-diagnosis is performed automatically when you switch on the ignition.

**Phase 1**

- » Test of the diagnosis-compatible system components with the vehicle at a standstill.



DTC telltale light slow-flashes.

**Phase 2**

- » Pullaway test of the system components with diagnostic capability.



DTC telltale light slow-flashes.

**DTC self-diagnosis completed**

- » The DTC symbol no longer shows.
- Check all the warning and telltale lights.





DTC self-diagnosis not completed

The DTC function is not available, because self-diagnosis did not complete. (The motorcycle has to reach a defined minimum speed with the engine running for the wheel-speed sensors to be checked: min 5 km/h)

If an indicator showing an DTC fault appears when DTC self-diagnosis completes:

- You can continue to ride. Bear in mind that the DTC function is not available or the functionality might be subject to certain restrictions.
- Have the fault rectified as quickly as possible by a specialist workshop, preferably an authorised BMW Motorrad dealer.

## Running in Engine

- Until the running-in check (first inspection), vary the throttle opening and engine-speed range frequently; avoid riding at constant engine rpm for prolonged periods.
- Try to do most of your riding during this initial period on twisting, fairly hilly roads.
- Comply with the rpm limits for running in.



Running-in speed

<7000 min<sup>-1</sup> (Odometer reading 0...300 km)

<9000 min<sup>-1</sup> (Odometer reading 300...1000 km)

no full load (Odometer reading 0...1000 km)

- Note the mileage after which the running-in check should be carried out.



### NOTICE

Engine rpm is governed by the electronic engine management system until the vehicle has undergone its running-in check. The authorised BMW Motorrad dealer deactivates this rpm governing function when the motorcycle is brought in for its running-in check. ◀



Mileage until the running-in check

500...1200 km



Engine-rpm governing until the running-in check

max 9000 min<sup>-1</sup>

## Brake pads

New brake pads have to bed down before they can achieve their optimum friction levels. You can compensate for this initial reduction in braking efficiency by exerting greater pressure on the levers.

### WARNING

#### New brake pads.

Longer stopping distance. Risk of accident.

- Apply the brakes in good time. ◀

## Tyres

New tyres have a smooth surface. This must be roughened by riding in a restrained manner at various heel angles until the tyres are run in. This running in procedure is essential if the tyres are to achieve maximum grip.

### WARNING

#### New tyres losing grip on wet roads and at extreme bank angles.

Risk of accident

- Ride carefully and avoid extremely sharp inclines. ◀

## Shifting gear Gearshift light

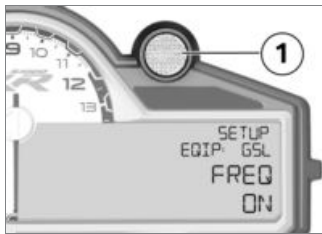

Gearshift light **1** shows the rider the engine-speed thresholds for shifting gear.

## Shift speed

When the motorcycle is on the move, gearshift light **1** indicates the engine speed at which the rider should upshift.

- Gearshift light flashes at preset frequency: approaching upshift rpm.
- Gearshift light goes out: the engine has reached the ideal speed for an upshift.

The engine-speed thresholds and the way in which the gearshift light indicates the various states can be customised in the SETUP EQUIPMENT sub-menu.

## Shift assistant Pro

- with Pro shift assistant<sup>OE</sup>

The shift assistant assists upshifts and downshifts without the rider having to pull the clutch. This is not an automatic-shift system. The rider is the most

important part of the system and decides when to shift gears.

The twistgrip has to be turned to open the throttle for upshifts.

The twistgrip has to be turned to close the throttle for downshifts.



## NOTICE

See the section entitled "Engineering details" for more information on the Pro shift assistant. ◀



## NOTICE

Whenever the Pro shift assistant shifts gears, cruise control is automatically disengaged for safety reasons. ◀

- To engage a gear from neutral, pull the clutch and operate the shift lever.
- To shift into neutral, pull the clutch and operate the shift lever.



- To shift gears while riding, operate the shift lever without pulling the clutch.
  - » Sensor **1** on the selector rod registers the shift request and triggers shift assistance.
  - » When riding at a steady speed in a low gear at high engine rpm, an attempt to shift gear without pulling the clutch can cause a severe load-change reaction. BMW Motorrad recommends disengaging the clutch for shifts in these circumstances. It is advisable to avoid using the shift assistant at engine speeds close to the

limits at which the governor cuts in to limit engine rpm.

- » Shift assistance is not available in the following situations:
  - with the clutch lever pulled
  - shift lever not in its initial position
  - Upshift request with throttle twistgrip closed on engine over-run
- After a gearshift, you must fully release the shift lever before another gearshift with the shift assistant can take place.

## Brakes

### How can stopping distance be minimised?

Each time the brakes are applied, a load distribution shift takes place with the load shifting forward from the rear to the front wheel. The sharper the vehicle decelerates, the more load is shifted to the front wheel. The

higher the wheel load, the more braking force can be transmitted without the wheel locking.

To optimise stopping distance, apply the front brakes rapidly and keep on increasing the force you apply to the brake lever. This makes the best possible use of the dynamic increase in load at the front wheel. Remember to pull the clutch at the same time. BMW Motorrad ABS prevents the front wheel from locking up. In the "panic braking situations" that are trained so frequently, braking force is applied as rapidly as possible and with the rider's full force applied to the brake levers; under these circumstances, the dynamic shift in load distribution cannot keep pace with the increase in deceleration and the tyres cannot transmit the full braking force to the surface of the road. In the absence of load on the wheel the ABS

has to intervene to prevent the front wheel from locking even if the brakes are applied only very lightly. This leads to a reduced braking effect.

### Hazard braking

– with ABS Pro<sup>OE</sup>

If you brake sharply from a speed in excess of 50 km/h the brake light flashes rapidly as a warning for road users behind you.

If you brake until your speed is less than 15 km/h the hazard warning lights start to flash as well. The hazard warning lights switch off automatically as soon as you start to accelerate and vehicle speed reaches 20 km/h.

## Descending mountain passes



### WARNING

#### Braking only with the rear brake on mountain descents.

Brake fade. Destruction of the brakes due to overheating.

- Use both front and rear brakes, and make use of the engine's braking effect as well. ◀

#### Wet and dirty brakes

Wetness and dirt on the brake discs and the brake pads diminish braking efficiency.

Delayed braking action or poor braking efficiency must be reckoned with in the following situations:

- Riding in the rain or through puddles of water.
- After the vehicle has been washed.

- Riding on salted or gritted roads.
- After work has been carried on the brakes, due to traces of oil or grease.
- Riding on dirt-covered surfaces or off-road.

### **WARNING**

#### **Moisture and dirt.**

Diminished braking effect.

- Apply the brakes lightly while riding to remove wetness and dirt, or dismount and clean the brakes.
- Think ahead and brake in good time until full braking efficiency is restored.◀

#### **ABS Pro**

- with ABS Pro<sup>OE</sup>

### **Physical limits applicable to motorcycling**

#### **WARNING**

#### **Braking when cornering.**

Risk of crash despite ABS Pro

- Invariably, the rider bears responsibility for assessing road and traffic conditions and adapting his or her style of riding accordingly.
- Do not take risks that would negate the additional safety offered by this system.◀

ABS Pro is available in all riding modes. Assistance varies, depending on the riding mode selected and decreases in 3 stages from RAIN to DYNAMIC PRO.

#### **Assistance by ABS Pro**

- RAIN and ROAD: maximum assistance.
- DYNAMIC: less assistance.

- DYNAMIC PRO: slight assistance.

#### **Possibility of a fall not precluded**

Although ABS Pro provides the rider with valuable assistance and constitutes a huge advance in safety for braking with the motorcycle banked for cornering, it cannot under any circumstances be considered as redefining the physical limits that apply to motorcycling. It is still possible for these limits to be overshoot due to misjudgement or rider error. In extreme cases this can result in a crash.

#### **Use on public roads**

ABS Pro helps make the motorcycle even safer for riding on public roads. When the brakes are applied because of an unforeseen hazard when the motorcycle is banked for cornering,

within the physical limits that apply to motorcycling the system prevents the wheels from locking and skidding away.

### NOTICE

ABS Pro was not developed to enhance individual braking performance with the motorcycle banked into corners in situations approaching the limits of performance. ◀

## Parking your motorcycle

### Side stand

- Switch off the engine.
- On a gradient, the motorcycle should always face uphill; select 1st gear.

### ATTENTION

**Poor ground underneath the stand.**

Risk of damage to parts if vehicle topples.

- Always check that the ground under the stand is level and firm. ◀
- Extend the side stand and prop the motorcycle on the stand.

### ATTENTION

**Additional weight placing strain on the side stand.**

Risk of damage to parts if vehicle topples.

- Do not sit or lean on the vehicle while it is propped on the side stand. ◀
- If the camber of the roadway permits, turn the handlebars all the way to the left.

### Centre stand

– with centre stand<sup>OE</sup>

- Switch off the engine.

### ATTENTION

**Poor ground underneath the stand.**

Risk of damage to parts if vehicle topples.

- Always check that the ground under the stand is level and firm. ◀

### ATTENTION

**Centre stand retracts due to severe movements.**

Risk of damage to parts if vehicle topples.

- Do not lean or sit on the vehicle with the centre stand extended. ◀
- Extend the centre stand and lift the motorcycle onto the stand.
- On a gradient, the motorcycle should always face uphill; select 1st gear.

## Refuelling

### Fuel grade

For optimum fuel consumption, fuel should be sulphur-free or with the lowest sulphur content possible.

#### ATTENTION

### Leaded fuel.

Damage to catalytic converter.

- Do not attempt to run the vehicle on leaded fuel or fuel with metallic additives, e.g. manganese or iron. ◀

#### ATTENTION

### Engine operation with ethanol E85.

Damage to engine and fuel supply system.

- Do not attempt to run the engine on ethanol E85, i.e. a fuel with an ethanol content of 85 %, or flex fuel. ◀

- You can run the engine on fuel with a maximum ethanol content of 10 %, i.e. E10.

 Recommended fuel grade
Super Plus, unleaded (max. 10 % ethanol, E10) 98 ROZ/RON 91 AKI

## Refuelling

#### WARNING

### Fuel is highly flammable.

Risk of fire and explosion.

- Do not smoke. Never bring a naked flame near the fuel tank. ◀

#### WARNING

### Escape of fuel due to heat-induced expansion if fuel tank is overfilled.

Risk of falling

- Do not overfill the fuel tank. ◀

#### ATTENTION

### Fuel attacks plastic surfaces.

Surfaces become unsightly or dull.

- Clean plastic parts immediately after contact with fuel. ◀
- Make sure the ground is level and firm and place the motorcycle on its side stand.

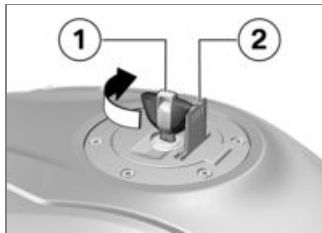

- Open the protective cap **2**.
- Use ignition key **1** to unlock fuel filler cap by turning it

clockwise, and flip the cap open.



- Refuel with fuel of the grade stated above; do not fill the tank past the bottom edge of the filler neck.

### NOTICE

When refuelling after running on reserve, make sure that you top up the tank to a level above reserve, as otherwise the new level will not be registered and the FUEL! warning indicating that

the level is down to reserve will not be switched off.◀

### NOTICE

The “usable fuel capacity” specified in the technical data is the quantity that the fuel tank could hold if it had been run dry and the engine had cut out due to a lack of fuel.◀



Usable fuel capacity

approx. 20 l



Fuel reserve

approx. 4 l

- Press the fuel tank cap down firmly to close.
- Remove the ignition key and close the protective cap.

## Securing motorcycle for transportation

- Make sure that all components that might come into contact with straps used to secure the motorcycle are adequately protected against scratching. Use adhesive tape or soft cloths, for example, for this purpose.



### ATTENTION

**Vehicle topples to side when being lifted on to stand.**

Risk of damage to parts if vehicle topples.



- Secure the vehicle to prevent it toppling, preferably with the assistance of a second person.◀
- Push the motorcycle onto the transportation flat and hold it in position: do not place it on the side stand.



## ATTENTION

### Trapping of components.

Component damage

- Do not trap components such as brake lines or cable legs.◀

- At the front, loop a strap over the bottom fork bridge on each side.
- Pull the straps down and tight.



- At the rear, secure the straps to the rear footrests on both sides and tighten the straps.
- Tighten all the straps uniformly; the vehicle's suspension should be compressed as tightly as possible front and rear.



## Engineering details

General instructions.....	114
Anti-lock brake system .....	114
Traction control .....	117
Dynamic ESA.....	118
Riding mode .....	119
Riding mode RAIN .....	120
Riding mode ROAD.....	121
Riding mode DYNAMIC.....	122
Riding mode DYNAMIC PRO .....	123
Deactivatable suspension and running-gear control systems .....	125
Shift assistant Pro .....	125

## General instructions

To find out more about engineering go to:

**bmw-motorrad.com/technology**

### Anti-lock brake system Partially integral brakes

Your motorcycle is equipped with partially integral brakes. Both front and rear brakes are applied when you pull the handbrake lever. The footbrake lever acts only on the rear brake.



#### ATTENTION

**The integral braking function makes it very difficult to spin the rear wheel by opening the throttle with the front brake applied to keep the motorcycle stationary (burn-out).**

Attempted burn-outs can result in damage to the rear brake

and the clutch. Integral pressure build-up is supported even when the ABS is switched off.

- Do not attempt a burn-out.◀

### How does ABS work?

The amount of braking force that can be transferred to the road depends on factors that include the coefficient of friction of the road surface. Loose stones, ice and snow or a wet road all have much lower coefficients of friction than a clean, dry asphalt surface. The lower the coefficient of friction, the longer the braking distance.

If the rider increases braking pressure to the extent that braking force exceeds the maximum transferable limit, the wheels start to lock and the vehicle loses its directional stability; a fall is imminent. Before this situation can occur, ABS intervenes and adapts braking pressure to the

maximum transferable braking force, so the wheels continue to turn and directional stability is maintained irrespective of the condition of the road surface.

### What are the effects of surface irregularities?

Humps and surface irregularities can cause the wheels to lose contact temporarily with the road surface; if this happens the braking force that can be transmitted to the road can drop to zero. If the brakes are applied under these circumstances the ABS has to reduce braking force to ensure that directional stability is maintained when the wheels regain contact with the road surface. At this instant the ABS must assume an extremely low coefficient of friction, so that the wheels will continue to rotate under all imaginable circumstances, because this is the precondition

for ensuring directional stability. As soon as it registers the actual circumstances, the system reacts instantly and adjusts braking force accordingly to achieve optimum braking.

### **What feedback does the rider receive from the BMW Motorrad Race ABS?**

If the ABS has to reduce braking force on account of the circumstances described above, vibration is perceptible through the handbrake lever.

When the handbrake lever is pulled, brake pressure is also built up at the rear wheel by the integral function. If the brake pedal is depressed after the handbrake lever is pulled, the brake pressure built up beforehand is perceptible as counter-pressure sooner than is the case when the brake pedal is

depressed either before or at the same time as the brake lever is pulled.

### **Rear wheel lift**

Even under severe braking, a high level of tyre grip can mean that the front wheel does not lock up until very late, if at all. Consequently, ABS does not intervene until very late, if at all. Under these circumstances the rear wheel can lift off the ground, and the outcome can be a high-siding situation in which the motorcycle can flip over.



### **WARNING**

#### **Rear wheel lift due to severe braking.**

Risk of falling

- When you brake sharply, bear in mind that ABS control cannot always be relied on to prevent the rear wheel from lifting clear of the ground. ◀

### **Special situations**

The speeds of the front and rear wheels are compared as one means of detecting a wheel's incipient tendency to lock. If the system registers implausible values for a lengthy period the ABS is deactivated for safety reasons and an ABS fault message is issued. Self-diagnosis has to complete before fault messages can be issued.

In addition to problems with the BMW Motorrad Race ABS, exceptional riding conditions can lead to a fault message being issued.

#### **Exceptional riding conditions:**

- Heating up with the motorcycle on an auxiliary stand, in neutral or with a gear engaged.
- Rear wheel locked by the engine brake for a lengthy period, for example while descending steep gradients.

If a fault message is issued on account of exceptional riding conditions as outlined above, you can reactivate the ABS function by switching the ignition off and on again.

## What significance devolves on regular maintenance?

### WARNING

#### **Brake system not regularly serviced.**

Risk of accident

- In order to ensure that the BMW Motorrad Race ABS is always maintained in optimum condition, it is essential for you to comply strictly with the specified inspection intervals. ◀

## Reserves for safety

The potentially shorter braking distances which BMW Motorrad Race ABS permits must not be used as an excuse for careless riding. ABS is primarily a means of ensuring a safety margin in genuine emergencies.

Take care when cornering! When you apply the brakes on a corner, the motorcycle's weight and momentum take over and even BMW Motorrad Race ABS is unable to counteract their effects.

## Evolution of Race ABS to ABS Pro

– with ABS Pro<sup>OE</sup>

Until now, the BMW Motorrad Race ABS helped ensure a very high degree of safety for braking with the motorcycle upright and travelling in a straight line. Now ABS Pro offers enhanced safety for braking in corners as well.

ABS Pro prevents the wheels from locking even under sharp braking. ABS Pro reduces abrupt changes in steering force, particularly in panic-braking situations, counteracting the vehicle's otherwise natural but undesirable tendency to straighten up.

## ABS intervention

Technically speaking, depending on the riding situation ABS Pro adapts ABS intervention to the motorcycle's bank angle. Signals for rate of roll and rate of yaw and lateral acceleration are used to calculate bank angle. These signals come from the angular rate sensor, an integral component of Dynamic Traction Control DTC and Dynamic ESA.

As the motorcycle is heeled over more and more as it banks into a corner, an increasingly strict limit is imposed on the brake-pressure gradient for the start of

brake application. This slows the build-up of brake pressure to a corresponding degree. Additionally, pressure modulation is more uniform across the range of ABS intervention.

### Advantages for the rider

The advantages of ABS Pro for the rider are sensitive response and high braking and directional stability combined with best-case deceleration of the motorcycle, even when cornering.

## Traction control

### How does traction control work?

Traction control is available in two versions

- **without** provision for the bank angle: Automatic Stability Control ASC
- ASC is a rudimentary function intended to prevent falls.

- **with** provision for bank angle: Dynamic Traction Control DTC
- DTC controls more comfortably and is suitable for improving lap times on the race track.

The traction control system compares the speed of rotation at the circumferences of the front wheel and the rear wheel. The differential is used to compute slip as a measure of the reserves of stability available at the rear wheel. If slip exceeds a certain limit, the engine management system intervenes and adapts engine torque accordingly.

### WARNING

#### Risky riding.

Risk of accident despite DTC.

- Invariably, it remains the rider's responsibility to adapt riding style to riding conditions.

- Do not take risks that would negate the additional safety offered by this system. ◀

### Special situations

In accordance with the laws of physics, the ability to accelerate is restricted more and more as the angle of heel increases. Consequently, there can be a perceptible reduction in acceleration out of very tight bends.

The speeds of the front and rear wheels are compared and DTC, unlike ASC, also takes the bank angle into account in processing data to detect the rear wheel's incipient tendency to spin or slip sideways.

– with Dynamic Traction Control (DTC)<sup>OE</sup>

If the electronic processor receives values for the bank angle that it considers implausible over a lengthy period, a dummy value is used for the bank angle or the DTC function is switched off.

Under these circumstances the indicator for a DTC fault shows. Self-diagnosis has to complete before fault messages can be issued.

The BMW Motorrad Traction Control can shut down automatically under the exceptional riding conditions outlined below.

### Exceptional riding conditions:

- Riding for a lengthy period with the front wheel lifted off the ground (wheelie).
- Rear wheel rotating with the vehicle held stationary by applying the front brake (burn-out).

– Heating up with the motorcycle on an auxiliary stand, in neutral or with a gear engaged.

If the coding plug for the DYNAMIC PRO riding mode is not inserted, accelerating the motorcycle to a defined minimum speed after switching the ignition off and then on again reactivates the DTC.



Minimum speed for activation of DTC

min 10 km/h

If the front wheel lifts clear of the ground under severe acceleration, the ASC or DTC reduces engine torque in the RAIN and ROAD riding modes until the front wheel regains contact with the ground.

Wheelie assistance is deactivated in the DYNAMIC PRO riding mode.

Under these circumstances, BMW Motorrad recommends rolling the throttle slightly closed so as to restore stability with the least possible delay.

When riding on a slippery surface, never snap the throttle twistgrip fully closed without pulling the clutch at the same time. Engine braking torque can cause the rear wheel to skid, with a corresponding loss of stability. The BMW Motorrad DTC is unable to control a situation of this nature.

## Dynamic ESA

– with Dynamic ESA<sup>OE</sup>

### Possible settings

Dynamic ESA enables you to adjust your motorcycle's suspension to suit the load and the surface conditions.



By interpreting ride height sensor signals, Dynamic ESA detects movements in the chassis and suspension and responds by adjusting the damping valves. The chassis and suspension will thus be adapted to the characteristics of the terrain.

The DYNAMIC setting enables you to set the damping to a more sporty setup than that offered by ROAD, which is the basic setting.

The setting of the chassis and suspension and the number of the selectable damping variants depend on the riding mode selected. The damping defined by the riding mode can be changed by the rider.

If the coding plug is not fitted, the basic setting specified by the riding mode will be set after each mode change. If the coding plug

is fitted, the driver's adjustments are retained for all riding modes.

## Riding mode

### Selection

#### Riding mode selection

Different riding modes enable the motorcycle's characteristics to adapt to the prevailing weather conditions, the road and traffic, and the rider's style of riding:

RAIN

ROAD (standard mode)

– with Pro riding modes<sup>OE</sup>

DYNAMIC

DYNAMIC PRO (only with coding plug inserted)

– with power reduction<sup>OE</sup>



**Increased engine power available in all riding**

## modes with coding plug inserted, vehicles with power reduction.

Risk of accident

- It is important for the rider intending to use these more sporty ride modes to familiarise himself/herself with their characteristics.
- Do not use the coding plug for riding on public roads. ◀

Each of these modes produces perceptible differences in the way the motorcycle behaves. ABS and/or ASC/DTC can be switched off in each riding mode. The explanations below apply with the corresponding suspension and running-gear control systems switched on. The mode last selected is automatically reactivated after the ignition has been switched off and then on again.

The basic rule is: the sportier the riding mode you select, the more directly can you tap into the engine's reserves of power. At the same time, the level of rider assistance that the ABS and ASC/DTC systems offer decreases accordingly.

The RAIN, ROAD and DYNAMIC riding modes are set up for riding with standard tyres recommended by BMW Motorrad. The DYNAMIC PRO riding mode is for tyres with very good grip, surfaces with a very high level of grip, and one-up riding. Consequently, you must always bear the following in mind with regard to your selection of a riding mode:

- The sportier the setting, the greater the challenge to your riding skill!
- It is the rider's responsibility to select the correct riding mode. For example, the DYNAMIC

PRO riding mode is totally unsuitable for wet surfaces.

### Mode changes

A changeover of the functions in the engine management system, the ABS and the ASC or, as applicable, the DTC systems while riding is possible only in certain operating states:

- No drive torque at the rear wheel
- No brake pressure in the brake system.

One of the following preconditions has to be satisfied in order for this condition to be achieved:

- The vehicle is at a standstill with the ignition switched on.
- With the vehicle on the move, the throttle twistgrip must be turned back and the brake levers must be in the released positions.

The desired riding mode is initially preselected. The mode change does not take place until the control systems in question are all in the appropriate state. The selection menu does not disappear from the display until the change of riding modes has completed.

## Riding mode RAIN

### Wet roads

The RAIN riding mode offers safety and directional stability on wet roads or roads with a similarly low coefficient of friction.

### ABS

- The ABS always intervenes early enough to prevent as effectively as possible the wheels from locking and the rear wheel from lifting off the ground.
- Maximum assistance with integral pressure build-up when

only the handbrake lever is pulled.

- ABS for the rear wheel is switched on.
- Rear-wheel lift detection is switched on. The rear wheel should remain in contact with the ground at all times.

– with ABS Pro<sup>OE</sup>

ABS Pro is fully available. The tendency of the motorcycle to straighten up when the brakes are applied with the machine banked for cornering is reduced to a minimum.

## **ASC**

- The ASC intervenes early enough to prevent the rear wheel from spinning whenever possible. ASC offers maximum assistance.
- Front-wheel lift detection is ON and prevents the front wheel from lifting off the ground.

– with Dynamic Traction Control (DTC)<sup>OE</sup>

## **DTC**

- The DTC intervenes early enough to prevent the rear wheel from spinning whenever possible. DTC offers maximum assistance.
- Front-wheel lift detection is ON and prevents the front wheel from lifting off the ground.

– with Dynamic ESA<sup>OE</sup>

## **Dynamic ESA**

- The ROAD and DYNAMIC variants can be selected.
- Basic setting = ROAD

## **Throttle response**

- Restrained: Power increase when you open the throttle is virtually linear, engine response is soft.
- The engine's maximum torque is not made available. The

torque curve for rain is imposed.

- Motorcycles with power reduction: With the coding plug inserted the torque curve for rain is imposed. Homologation for riding on public roads is voided.
- Overrun cut-off is activated.
- The thrust acoustics are off.

## **Riding mode ROAD**

### **Standard mode**

The ROAD riding mode offers safety and directional stability on dry roads.

### **ABS**

- The behaviour of the ABS is the same as in RAIN mode.
- The ABS always intervenes early enough to prevent as effectively as possible the wheels from locking and the rear wheel from lifting off the ground.

- Maximum assistance with integral pressure build-up when only the handbrake lever is pulled.
- ABS for the rear wheel is switched on.
- Rear-wheel lift detection is switched on. The rear wheel should remain in contact with the ground at all times.
- with ABS Pro<sup>OE</sup>

ABS Pro is fully available. The tendency of the motorcycle to straighten up when the brakes are applied with the machine banked for cornering is reduced to a minimum.

### **ASC**

- The ASC intervenes early enough to prevent the rear wheel from spinning whenever possible. However, ASC offers less assistance than in RAIN mode.

- Front-wheel lift detection is ON and prevents the front wheel from lifting off the ground.
- with Dynamic Traction Control (DTC)<sup>OE</sup>

### **DTC**

- The DTC intervenes later than in RAIN mode, so it is possible to induce slight drift when exiting corners.
- Front-wheel lift detection is ON and prevents the front wheel from lifting off the ground.

- with Dynamic ESA<sup>OE</sup>

### **Dynamic ESA**

- The ROAD and DYNAMIC variants can be selected.
- Basic setting = ROAD

### **Throttle response**

- Engine response is optimum and direct.
- The engine's maximum torque is made available.

- Motorcycles with power reduction: With the coding plug inserted the torque curve for maximum torque is imposed. Homologation for riding on public roads is voided.
- Overrun cut-off is activated.
- The thrust acoustics are off.

## **Riding mode DYNAMIC**

- with Pro riding modes<sup>OE</sup>

### **Dynamic on dry roads**

The DYNAMIC riding mode is suitable for sporty riding on dry roads. It is the sportiest riding mode available without the coding plug inserted.

### **ABS**

- In this riding mode, the ABS intervenes later than in ROAD mode. The wheels are still prevented from locking.

- Lift detection for the rear wheel is reduced. The rear wheel can lift slightly clear of the ground.
- Assistance with integral pressure build-up is reduced.
- ABS for the rear wheel is switched on. Assistance is less than in the ROAD riding mode.
- ABS Pro is available. Assistance is less than in the ROAD riding mode.

## DTC

- The DTC intervenes later than in ROAD mode, so it is possible to induce drift when exiting corners.
- Front-wheel lift detection is ON, but it offers less assistance. Agility comes before stability in the DYNAMIC riding mode, so slight wheelies are possible.

- with Dynamic ESA<sup>OE</sup>

## Dynamic ESA

- The ROAD and DYNAMIC variants can be selected.
- Basic setting = DYNAMIC

## Throttle response

- Engine response is optimum and direct.
- The engine's maximum torque is made available.
- Motorcycles with power reduction: With the coding plug inserted the torque curve for maximum torque is imposed. Homologation for riding on public roads is voided.
- Overrun cut-off is activated.
- The thrust acoustics are on.

## Riding mode DYNAMIC PRO

- with Pro riding modes<sup>OE</sup>

## Sporty one-up riding

DYNAMIC PRO is the sportiest riding mode. The DYNAMIC PRO mode cannot be activated unless the coding plug is inserted.

The DYNAMIC PRO riding mode was developed for situations in which the rider has an open view of the road ahead and the surroundings and is for riding on dry surfaces with the high level of grip generally encountered only on race tracks. Similarly, the assumption on which the parameter settings for this riding mode are based is that the motorcycle is fitted with tyres with a very high level of surface grip and is ridden one-up.

## ABS

- In this riding mode, the ABS intervenes later than in DYNAMIC mode. The shortest braking distances can be achieved.
- Lift detection for the rear wheel provides only minimal assistance. The rear wheel can lift clear of the ground.
- Assistance with integral pressure build-up is reduced sooner than in the DYNAMIC riding mode.
- ABS for the rear wheel is switched on. Assistance is less than in the DYNAMIC riding mode.
- In the DYNAMIC PRO riding mode the ABS Pro functions have only minimal support.
- Note that deactivating the ABS means that the ABS remains switched off even after the ig-

niton has been switched off and then on again.

## DTC

- The controller of the DTC system assumes that the vehicle is fitted with tyres with the maximum level of grip.
- DTC offers only very slight assistance.
- Slip is highest in the DYNAMIC PRO riding mode.
- Maximum acceleration is achieved.
- The DTC intervenes so late that lengthy drifts are possible.
- Front-wheel lift detection is deactivated. Agility comes before stability in this sporty riding mode, so any wheelies are possible. It is up to the rider to control wheelies and prevent the motorcycle from flipping over backwards in extreme cases.

- Note that deactivating the DTC means that the DTC remains switched off even after the ignition has been switched off and then on again.

- with Dynamic ESA<sup>OE</sup>

## Dynamic ESA

- The ROAD and DYNAMIC variants can be selected.
- Basic setting = DYNAMIC

## Throttle response

- Engine response is optimum and direct.
- The engine's maximum torque is made available.
- Motorcycles with power reduction: With the coding plug inserted the torque curve for maximum torque is imposed. Homologation for riding on public roads is voided.
- Engine power, power increase and throttle response are all set up for maximum sportiness.

- Overrun cut-off is activated.
- The thrust acoustics are on.

## Deactivatable suspension and running-gear control systems

### Riding without ABS, ASC or DTC

ABS and ASC or, as applicable DTC can be switched off individually or together in all riding modes. Under these circumstances bear in mind the lack of assistance from the suspension and running-gear control systems:

#### ABS switched off

- The ABS telltale and warning light shows.
- ABS assistance is deactivated. Under these circumstances the front wheel can lock up.

- Assistance with integral pressure build-up is in accordance with the selected riding mode. burn-outs are not permitted even with the ABS switched off.
- ABS for the rear wheel is deactivated. Under these circumstances, the rear wheel can lock up.
- Rear-wheel lift detection is deactivated. The rear wheel can lift clear of the ground.
- with ABS Pro<sup>OE</sup>
- ABS Pro is not available.

#### ASC switched off

- The ASC telltale and warning light shows.
- ASC assistance is deactivated. Any drifts are possible.
- Front-wheel lift detection is deactivated. Any wheelies are possible. There is a possibility

of the motorcycle flipping over backwards.

- with Dynamic Traction Control (DTC)<sup>OE</sup>

#### DTC switched off

- The DTC telltale and warning light shows.
- DTC assistance is deactivated. Any drifts are possible.
- Front-wheel lift detection is deactivated. Any wheelies are possible. There is a possibility of the motorcycle flipping over backwards.

#### Shift assistant Pro

- with Pro shift assistant<sup>OE</sup>

Your vehicle is equipped with a shift assistant, a system originally developed for racing and now adapted for riding on public roads. It permits upshifts and downshifts without declutching in virtually all load and rpm ranges.

## Advantages

- 70-80 % of all gearshifts on a trip can be done without using the clutch.
- Less relative movement between rider and passenger because the shift pauses are shorter.
- It is not necessary to close the throttle when upshifting under acceleration; the throttle valve remains open.
- When braking and downshifting (throttle valve closed), engine speed is automatically adjusted by blipping the throttle.
- Shift time is shorter than a gearshift with clutch actuation.

In order for the system to identify a request for a gearshift, the rider has to move the shift lever from its idle position in the desired direction against the force of the spring through a certain "over-travel" at ordinary speed or rap-

idly and keep the shift lever in this position until the gearshift is completed. It is not necessary to increase the force applied to the shift lever while shifting is in progress. Once the gearshift has completed the shift lever has to be fully released before another gearshift with the Pro shift assistant can take place. When shifting gears with the Pro shift assistant, the rider has to keep load state (throttle twistgrip position) constant before and during the gearshift. A change in the position of the throttle twistgrip during a gearshift can cause the function to abort and/or lead to a missed shift. The Pro shift assistant provides no assistance for the gearshift if the rider de-clutches.

## Downshifting

- Downshifting is assisted until maximum rpm for the target gear to be selected is reached.

- This prevents overrevving.



Maximum engine speed

max 12000 min<sup>-1</sup>

## Upshifting

- Upshifting is assisted until idle rpm for the target gear to be selected is reached.
- This prevents the engine from dropping below idle speed.



Idle speed

1250 min<sup>-1</sup> (Engine at regular operating temperature)



## Maintenance

General instructions.....	128
Toolkit .....	128
Front-wheel stand .....	129
Rear-wheel stand .....	130
Engine oil .....	131
Brake system .....	133
Clutch .....	136
Coolant .....	137
Tyres .....	138
Rims and tyres.....	139
Wheels .....	139
Lighting.....	149
Body panels .....	154
Jump-starting.....	156
Battery.....	157

Fuses .....	162
Chain .....	163

## General instructions

The Maintenance chapter describes straightforward procedures for checking and replacing certain wear parts.

Special tightening torques are listed as applicable. The tightening torques for the threaded fasteners on your vehicle are listed in the section entitled "Technical data".

You will find information on more extensive maintenance and repair work in the Repair Manual on DVD for your vehicle, which is available from your authorised BMW Motorrad dealer.

Some of the work calls for special tools and a thorough knowledge of the technology involved. If you are in doubt, consult a specialist workshop, preferably your authorised BMW Motorrad dealer.

## Toolkit

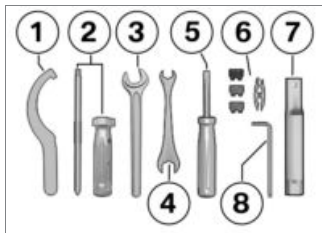

- 1** Hook wrench
  - without Dynamic ESA<sup>OE</sup>
  - Adjusting spring preload for rear wheel (► 90).
- 2** Reversible screwdriver blade  
Phillips PH1 and Torx T25
  - Remove the side panel (► 154).
  - Replacing bulbs for front and rear turn indicators (► 153).
- 3** Open-ended spanner  
Width across flats 14
  - 3** – Adjusting mirror arm (► 88).
  - Adjusting headlight beam throw (► 89).
- 4** Open-ended spanner  
Width across flats 8/10
- 5** Reversible-blade screwdriver with star-head and plain tips
  - without Dynamic ESA<sup>OE</sup>
  - Adjusting compression-stage damping for front wheel (► 92).
  - without Dynamic ESA<sup>OE</sup>
  - Adjust the rebound-stage damping for front wheel (► 93).
  - without Dynamic ESA<sup>OE</sup>
  - Adjusting rebound-stage damping for rear wheel (► 93).
- 6** Spare fuses with puller tool  
Miniature fuses, 4 A, 7.5 A and 10 A

- 7 Socket wrench  
Width across flats 17
- 8 Torx wrench, T30
  - Removing battery  
(▶▶▶ 160).

## Front-wheel stand

### Installing auxiliary stand at front wheel

#### ATTENTION

#### Use of the BMW Motorrad front wheel stand without also accompanying use of centre stand or auxiliary stand.

Risk of damage to parts if vehicle topples.

- Place the motorcycle on its centre stand or another auxiliary stand before lifting the front wheel with the BMW Motorrad front-wheel stand.◀

- with centre stand<sup>OE</sup>
  - Make sure the ground is level and firm and place the motorcycle on its centre stand.◀
- without centre stand<sup>OE</sup>
  - Place the motorcycle on an auxiliary stand; BMW Motorrad recommends the BMW Motorrad auxiliary stand.
  - Install the rear-wheel stand (▶▶▶ 130).◀



- Use basic stand (83 30 0 402 241) with the adapters (83 30 2 152 839).



- Insert service adapters (83 30 2 152 840) **1** into the front suspension on left and right.

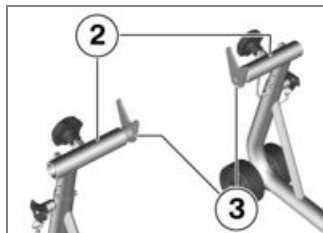

- Turn brackets **2** with long ends facing inwards.

- Adjust adapters **3** to the width of the service adapters inserted in the front suspension.
- Set the height of the auxiliary stand to raise the front wheel slightly clear of the ground.



- Engage the auxiliary stand in the front suspension and apply even pressure to push it down to the ground.

## Rear-wheel stand

### Install the rear-wheel stand



- Use basic stand with tool number (83 30 0 402 241) and adapters (83 30 2 152 839).



- Install service adapters (83 30 2 152 841) **1** in the rear wheel swinging arm on left and right and tighten to the specified torque.



Swinging-arm adapter to rear wheel swinging arm

20 Nm

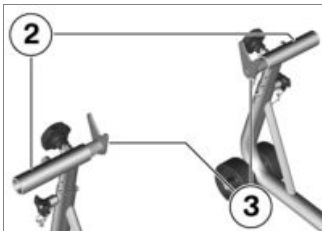

- Turn brackets **2** long ends out.
- Adjust adapters **3** to the width of the service adapters inserted in the rear wheel swinging arm.
- Set the height of the rear-wheel stand to raise the rear wheel slightly clear of the ground.



- Engage the rear-wheel stand in the rear wheel swinging arm and apply even pressure to push it down to the ground.

## Engine oil

### Checking engine oil level



**The oil level varies with the temperature of the oil. The higher the temperature, the higher the level of oil in the sump.**

Misinterpretation of the oil level

- Check the oil level only after a lengthy ride or when the engine is at operating temperature.◀
- Make sure the engine is at operating temperature and hold the motorcycle upright.
- Allow the engine to idle for one minute.
- Switch off the ignition.



- Check the oil level in oil-level indicator **1**.

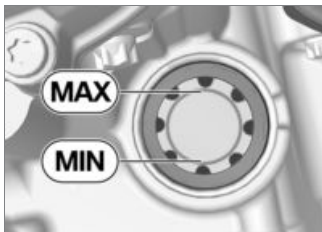

Engine oil, specified level

between MIN and MAX marks



Engine oil, capacity

SAE 5W-40, API SL / JASO MA2, Additives (e.g. molybdenum-based) are not permissible because they can attack coated components of the engine, BMW Motorrad recommends BMW Motorrad ADVANTEC Ultimate oil



Engine oil, capacity

approx. 3.5 l (with filter change)

If the oil level is below the minimum mark:

- Topping up the engine oil (►► 132).

If the oil level is above the maximum mark:

- Have the oil level corrected by a specialist workshop, preferably an authorised BMW Motorrad dealer.

### Topping up the engine oil

- Make sure the ground is level and firm and place the motorcycle on its stand.
- Wipe the area around the oil filler neck clean.



- Remove cap **1** of the oil filler neck.



### ATTENTION

#### Not enough or too much engine oil.

Engine damage

- Always make sure that the oil level is correct. ◀
- Top up the engine oil to the specified level.
- Checking engine oil level (►► 131).
- Install oil filler cap **1**.

## Brake system

### Checking function of brakes

- Operate the brake lever.
  - » The pressure point must be clearly perceptible.
- Press the footbrake lever.
  - » The pressure point must be clearly perceptible.

If pressure points are not clearly perceptible:

#### ATTENTION

### Work on brake system not in compliance with correct procedure.

Risk to operational reliability of the brake system.

- Have all work on the brake system undertaken by trained and qualified specialists. ◀
- Have the brakes checked by a specialist workshop, preferably

an authorised BMW Motorrad dealer.

### Checking front brake pad thickness

- Make sure the ground is level and firm and place the motorcycle on its stand.
- Turn the handlebars to the full-lock position.

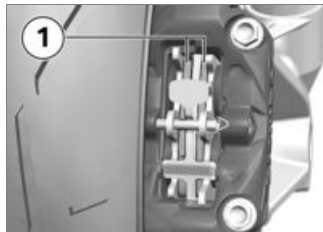

- Visually inspect the left and right brake pads to ascertain their thickness. Viewing direction: from the rear toward brake pads **1**.

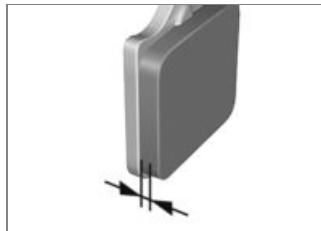

 Brake-pad wear limit, front

min 1.0 mm (Friction pad only, without backing plate)

If the brake pads are worn:

#### WARNING

### Brake-pad thickness less than permissible minimum.

Diminished braking effect. Damage to the brakes.

- In order to ensure the dependability of the brake system, do not permit the brake pads to

wear past the minimum permissible thickness. ◀

- Have the brake pads replaced by a specialist workshop, preferably an authorised BMW Motorrad dealer.
- If the brake pads installed are not genuine BMW Motorrad brake pads, it is absolutely essential to measure the thickness of the brake-pad carrier plates.



## WARNING

### Use of unsuitable brake pads.

Failure of the brake system due to loss of the brake pads.

- Use only brake pads with carrier plates at least 4.5 mm thick. ◀
- BMW Motorrad recommends installing only genuine BMW Motorrad brake pads.

## Check rear brake pad thickness

- Make sure the ground is level and firm and place the motorcycle on its stand.

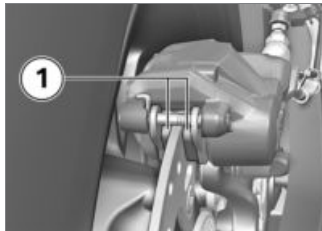

- Visually inspect the brake pads to ascertain their thickness. Viewing direction: from the rear toward brake pads **1**.



Brake-pad wear limit,  
rear

min 1.0 mm (Friction pad only,  
without backing plate)

If the wear indicating mark is no longer visible:



## WARNING

### Brake-pad thickness less than permissible minimum.

Diminished braking effect. Damage to the brakes.

- In order to ensure the dependability of the brake system, do not permit the brake pads to



wear past the minimum permissible thickness.◀

- Have the brake pads replaced by a specialist workshop, preferably an authorised BMW Motorrad dealer.

## Checking brake-fluid level, front brakes

### WARNING

#### Not enough brake fluid in brake fluid reservoir.

Considerably reduced braking power due to air in the brake system.

- Check the brake-fluid level at regular intervals.◀
- with centre stand<sup>OE</sup>
- Make sure the ground is level and firm and place the motorcycle on its centre stand.<

- without centre stand<sup>OE</sup>
- Make sure the ground is level and firm and hold the motorcycle upright.<
- Turn the handlebars to a position in which the brake fluid reservoir is horizontal.



- Check the brake fluid level in front reservoir **1**.

### NOTICE

Wear of the brake pads causes the brake fluid level in the reservoir to sink.◀

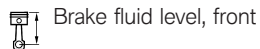

Brake fluid, DOT4

It is impermissible for the brake fluid level to drop below the MIN mark. (Brake-fluid reservoir horizontal, motorcycle upright)

If the brake fluid level drops below the permitted level:

- Have the defect rectified as quickly as possible by a specialist workshop, preferably an authorised BMW Motorrad dealer.

## Checking the brake-fluid level, rear brakes

- Make sure the ground is level and firm and hold the motorcycle upright.

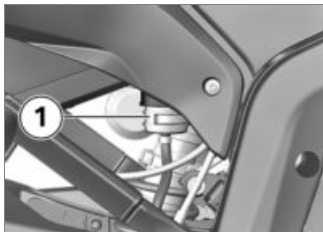

- Check the brake fluid level in rear reservoir **1**.



### NOTICE

Wear of the brake pads causes the brake fluid level in the reservoir to sink. ◀



Brake fluid level, rear

Brake fluid, DOT4

It is impermissible for the brake fluid level to drop below the MIN mark. (Brake-fluid reservoir horizontal, motorcycle upright)

If the brake fluid level drops below the permitted level:



### WARNING

**Not enough brake fluid in brake fluid reservoir.**

Considerably reduced braking power due to air in the brake system.

- Check the brake-fluid level at regular intervals. ◀
- Have the defect rectified as quickly as possible by a specialist workshop, preferably an authorised BMW Motorrad dealer.

## Clutch

### Checking clutch function

- Pull the clutch lever.
    - » The pressure point must be clearly perceptible.
- If the pressure point is not clearly perceptible:

- Have the clutch checked by a specialist workshop, preferably an authorised BMW Motorrad dealer.

## Checking clutch-lever play

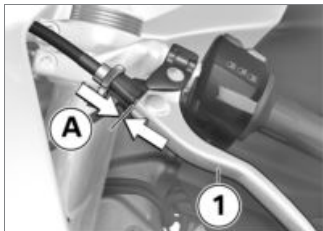

- Pull clutch lever **1** until resistance is perceptible.
- In this position, measure clutch play **A** between the handlebar fitting and the clutch lever.



Clutch-lever play

0.5...1.0 mm (at the handlebar fitting, with engine cold)

Clutch play is out of tolerance:

- Adjust the clutch-lever play (→ 137).

## Adjust the clutch-lever play



- To increase clutch play: turn screw **2** in the tightening direction, i.e. into the handlebar fitting.
- To reduce clutch play: turn screw **2** in the loosening direction, i.e. out of the handlebar fitting.
- Checking clutch-lever play (→ 137).
- Repeat the steps in this procedure until clutch play is set correctly.

## Coolant

### Check coolant level

- Make sure the ground is level and firm and place the motorcycle on its stand.



- Check the coolant level in expansion tank **1**. Viewing direction: From in front toward the inside of the right side panel.

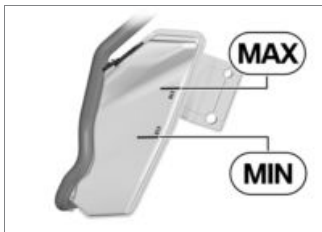

Coolant, specified level

between MIN and MAX marks on the expansion tank (engine cold)

If the coolant drops below the permitted level:

- Top up the coolant.

## Top up coolant



- Open cap **1** of the expansion tank.
- Top up coolant to specified level. Use a funnel with filler adapter or hose.
- Check coolant level (➡ 137).
- Close the cap of the expansion tank.

## Tyres

### Checking tyre pressure



**WARNING**

**Incorrect tyre pressure.**

Impairment of the motorcycle's handling characteristics. Shorter useful tyre life.

- Always check that the tyre pressures are correct. ◀



**WARNING**

**Tendency of valve inserts to open by themselves at high riding speeds.**

Sudden loss of tyre pressure.

- Install valve caps fitted with rubber sealing rings and tighten firmly. ◀
- Make sure the ground is level and firm and place the motorcycle on its stand.
- Check tyre pressures against the data below.



Tyre pressure, front

2.5 bar



Tyre pressure, rear

2.9 bar

If tyre pressure is too low:

- Correct tyre pressure.

## Rims and tyres

### Checking rims

- Make sure the ground is level and firm and place the motorcycle on its stand.
- Visually inspect the rims for defects.
- Have damaged rims inspected by a specialist workshop and replaced if necessary, preferably by an authorised BMW Motorrad dealer.

### Checking tyre tread depth



**WARNING**

**Riding with badly worn tyres**

Risk of accident due to impaired handling

- If applicable, have the tyres changed in good time before they wear to the minimum tread depth permitted by law.◀
- Make sure the ground is level and firm and place the motorcycle on its stand.
- Measure the tyre tread depth in the main tread grooves with wear marks.



### NOTICE

Wear indicators are built into the main profile grooves on each tyre. The tyre is worn out when the tyre tread has worn down to the level of the marks. The locations of the marks are indicated on the edge of the tyre, e.g. by the letters TI, TWI or by an arrow.◀

If the tyre tread is worn to minimum:

- Replace tyre or tyres, as applicable.

## Wheels

### Tyre recommendation

For each size of tyre, BMW Motorrad tests and classifies as roadworthy certain makes. BMW Motorrad cannot assess the suitability or provide any guarantee of road safety for other tyres.

BMW Motorrad recommends using only tyres tested by BMW Motorrad.

Detailed information is available from your authorised BMW Motorrad dealer or in the internet at:

**[bmw-motorrad.com](http://bmw-motorrad.com)**

## Effect of wheel size on chassis and suspension control systems

Wheel size is very important as a parameter for the frame and suspension control systems ASC and DTC. In particular, the diameter and the width of a vehicle's wheels are programmed into the control unit and are fundamental to all calculations. Any change in these influencing variables, caused for example by a switch to wheels other than those installed ex-works, can have serious effects on the performance of the control systems.

The sensor rings are essential for correct road-speed calculation, and they too must match the motorcycle's control systems and consequently cannot be changed.

If you decide that you would like to fit non-standard wheels to

your motorcycle, it is very important to consult a specialist workshop beforehand, preferably an authorised BMW Motorrad dealer. In these cases, the data programmed into the control units has to be changed to suit the new wheel sizes.

### Removing front wheel

- Place the motorcycle on an auxiliary stand; BMW Motorrad recommends the BMW Motorrad rear-wheel stand.
- Install the rear-wheel stand (▶ 130).
  - with centre stand<sup>OE</sup>
- Make sure the ground is level and firm and place the motorcycle on its centre stand.◀

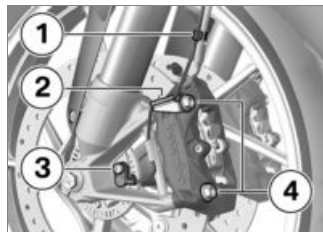

- Disengage the cable for the wheel-speed sensor from retaining clips **1** and **2**.
- Remove screw **3** and remove the wheel-speed sensor from its bore.
- Mask off the parts of the wheel rim that could be scratched in the process of removing the brake calipers.
- Remove securing screws **4** of the left and right brake calipers.

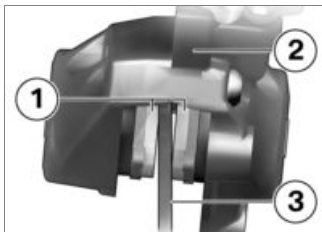

- Force the brake pads **1** slightly apart by rotational movement of the brake caliper **2** against brake disc **3**.



## ATTENTION

### Brake pads pushed together with brake caliper removed.

It is not possible to slip the brake caliper over the brake disc.

- Do not operate the brake lever while a brake caliper has been removed. ◀
- Carefully pull the brake calipers back and out until clear of the brake discs.

- Lift the front of the motorcycle until the front wheel is clear of the ground, preferably using a BMW Motorrad front-wheel stand.
- Installing auxiliary stand at front wheel (➡ 129).



- Slacken axle clamping screws **1**.

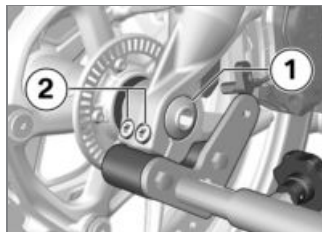

- Remove screw **1**.
- Slacken axle clamping screws **2**.
- Press quick-release axle slightly toward the inside, so as to be better able to grip it on the right-hand side.



- Withdraw quick-release axle **1**, support the front wheel when doing this.
- Set down front wheel and roll forwards out of the front suspension.

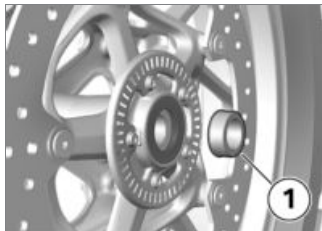

- Remove spacer bush **1** from the wheel hub.

### Installing front wheel

#### WARNING

#### Use of a non-standard wheel.

Malfunctions in operation of ABS and DTC.

- See the information on the effect of wheel size on the ABS and DTC systems at the start of this chapter. ◀



#### ATTENTION

#### Tightening threaded fasteners to incorrect tightening torque.

Damage, or threaded fasteners work loose.

- Always have the security of the fasteners checked by a specialist workshop, preferably an authorised BMW Motorrad dealer. ◀

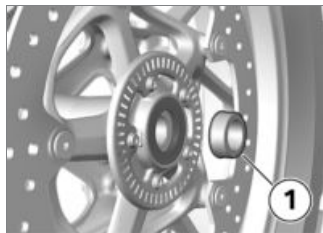

- Slip spacing bushing **1** into the wheel hub on the left-hand side.



## ATTENTION

### Front wheel installed wrong way round.

Risk of accident

- Note direction-of-rotation arrows on tyre or rim. ◀
- Roll the front wheel into position between the front forks.

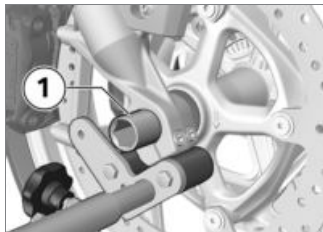

- Lift front wheel and fit quick-release axle **1**.
- Remove front-wheel stand and firmly compress front forks several times. Do not operate the brake lever in this process.

- Installing auxiliary stand at front wheel (→ 129).

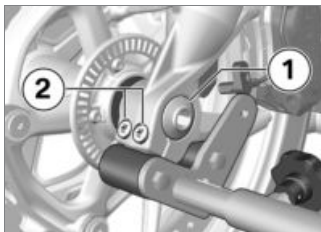

- Install screw **1** and tighten to specified torque. Counter-hold quick-release axle on the right-hand side.

 Screw in front-wheel quick-release axle

50 Nm

- Tighten axle clamping screws **2** to the specified tightening torque.



 Clamping screws in axle holder

Tightening sequence: Tighten screws six times in alternate sequence

19 Nm



- Tighten axle clamping screws **1** to the specified tightening torque.



 Clamping screws in axle holder

Tightening sequence: Tighten screws six times in alternate sequence

19 Nm

- Removing the front-wheel stand.
- Position left and right brake calipers on the brake discs.

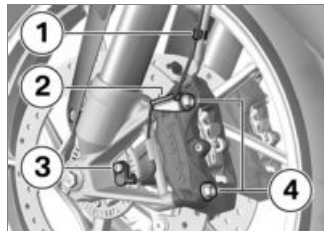

- Install securing screws **4** on left and right and tighten to specified tightening torque.

 Radial brake caliper to axle mount

38 Nm

- Remove the adhesive tape from the wheel rim.

 **WARNING**

**Brake pads not contacting the brake disc.**

Delayed braking effect.

- Before riding off, always check that the brakes bite as soon as

the brake lever is pulled or the brake pedal depressed. ◀

- Operate the brake several times until the brake pads are bedded.
- Seat the cable for the wheel-speed sensor in retaining clips **1** and **2**.
- Insert the wheel-speed sensor into the bore and install screw **3**.



Wheel-speed sensor to fork leg

Joining compound: Micro-encapsulated or medium-strength thread-locking compound

8 Nm

- Install the rear-wheel stand (▶▶ 130).
- Slip wooden chocks or similar under the rear wheel to prevent it from dropping out after the quick-release axle has been removed.

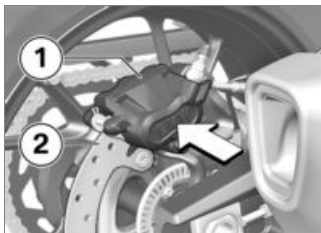

- Press brake caliper **1** against brake disc **2**.
- » Brake pistons are pushed back.

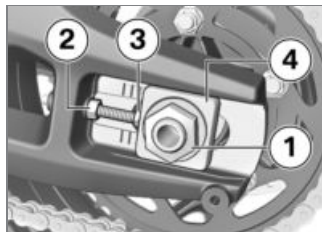

- Remove nut **1** with the washer.
- Slacken locknuts **2** on left and right.
- Slacken adjusting screws **3** on left and right.
- Remove adjusting plate **4** and push the axle in as far as it will go.

## Removing rear wheel

- Lift the motorcycle, preferably with a BMW Motorrad rear-wheel stand.

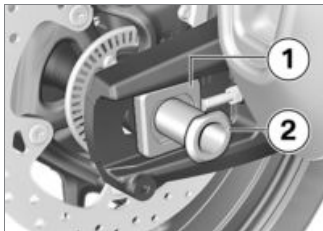

- Remove quick-release axle **2** and remove adjusting plate **1**.

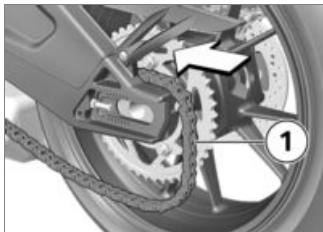

- Roll the rear wheel as far forward as possible and disengage chain **1** from the sprocket.



- Remove screw **1** and disengage the brake line from holder **2**.

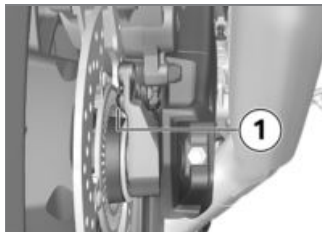

- When rolling the rear wheel clear of the motorcycle, take

care not to damage wheel-speed sensor **1**.

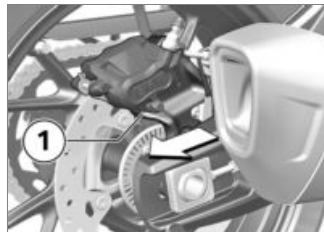

- Roll the rear wheel to the rear and clear of the swinging arm and at the same time pull brake-caliper carrier **1** back far enough to allow the rear wheel to clear it.



#### NOTICE

The sprocket and the spacer sleeves on left and right are loose fits in the wheel. Make sure that these parts are not damaged or lost on removal. ◀

## Installing the rear wheel

### ATTENTION

#### Change in tyre size.

Effect on control systems.

- Have the new parameters encoded by a specialist workshop, preferably an authorised BMW Motorrad dealer. ◀

### ATTENTION

#### Tightening threaded fasteners to incorrect tightening torque.

Damage, or threaded fasteners work loose.

- Always have the security of the fasteners checked by a specialist workshop, preferably an authorised BMW Motorrad dealer. ◀
- Roll the rear wheel on the support into the swinging arm as far as necessary to permit the

brake-caliper carrier to be inserted.

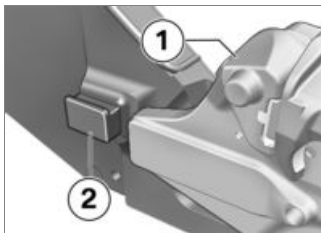

- Insert brake-caliper carrier 1 into guide 2.

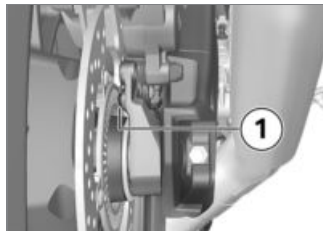

- When rolling the rear wheel into position, take care not to damage wheel-speed sensor 1.



- Roll the rear wheel further into the swinging arm, while push-

ing brake-caliper carrier **1** forward at the same time.



- Roll the rear wheel as far forward as possible and loop chain **1** over the sprocket.

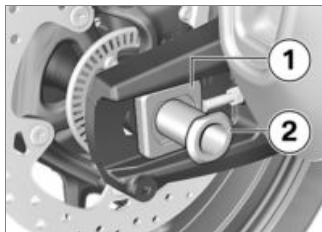

- Install right adjusting plate **1** in the swinging arm.
- Lift the rear wheel and work quick-release axle **2** through the adjusting plate and into the brake-caliper carrier and the rear wheel.
- Make sure that the quick-release axle fits into the recess for the flats.

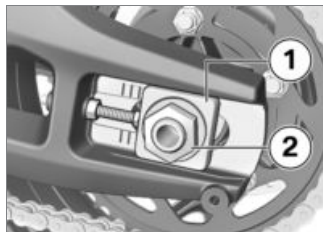

- Insert left adjusting plate **1**.
- Install nut **2** with its washer, but do not tighten the nut at this point.



- Secure the brake line in holder **2** and install screw **1**.

- Adjust the chain tension (→ 164).

## Lighting

### Replacing bulbs for low-beam headlight and high-beam headlight

#### NOTICE

The plug arrangement can differ from the illustration, depending on the bulb to be replaced. ◀

- Make sure the ground is level and firm and place the motorcycle on its stand.
- Switch off the ignition.



- Remove cover panel **1** to replace the bulb for the low-beam headlight.



- Remove cover panel **2** to replace the bulb for the high-beam headlight.



- Disconnect connector **3**.



- Disengage spring clip **4** at left and right and swing it up.
- Remove bulb **5** from the socket.

- Replace the defective bulb.

### NOTICE

Bulbs with higher light-intensity ratings are available through after-market suppliers. These bulbs burn out more rapidly and generate more heat than conventional bulbs. Under adverse conditions the extra heat can cause damage to the headlight. ◀



Bulbs for the low-beam headlight

H7 / 12 V / 55 W



Bulb for high-beam headlight

H7 / 12 V / 55 W

- Hold the bulb by the base only, in order to keep the glass free of foreign matter.

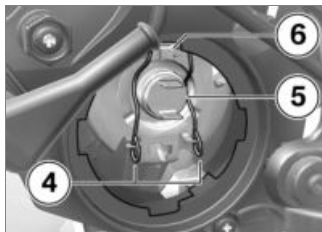

- Install bulb **5**. Begin by seating lug **6** and then press the bulb into the socket.
- Engage spring clip **4** in the catch on left and right.



- Connect plug **3**.

- Install the cover.

### Replacing bulb for left parking light

- Make sure the ground is level and firm and place the motorcycle on its stand.
- Switch off the ignition.



- Remove cover **1**.





- Push down retainer **2** (using a screwdriver if necessary) and pull socket **3** out of the headlight housing.

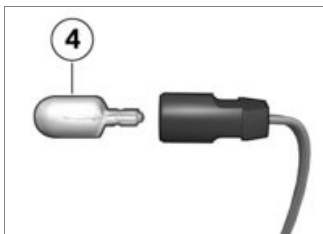

- Remove bulb **4** from the socket.

- Replace the defective bulb.



Bulb for parking light

W3W / 12 V / 3 W

- Use a clean, dry cloth to hold the bulb in order to keep the glass free of dirt and foreign matter.

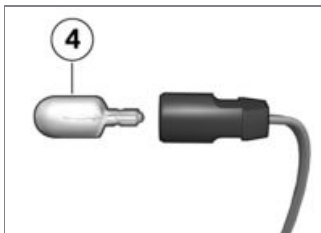

- Insert bulb **4** into the socket.

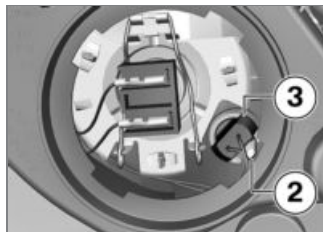

- Insert socket **3** into the headlight housing, making sure that retainer **2** engages.
- Install the cover.

### Replacing bulb for right side light

- Make sure the ground is level and firm and place the motorcycle on its stand.
- Switch off the ignition.



- Remove cover **1**.

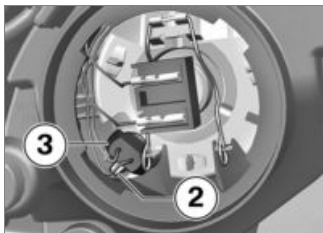

- Push down retainer **2** (using a screwdriver if necessary) and pull socket **3** out of the headlight housing.

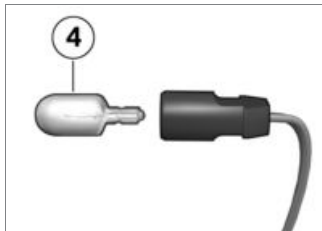

- Remove bulb **4** from the socket.
- Replace the defective bulb.



Bulb for parking light

W3W / 12 V / 3 W

- Use a clean, dry cloth to hold the bulb in order to keep the glass free of foreign matter.

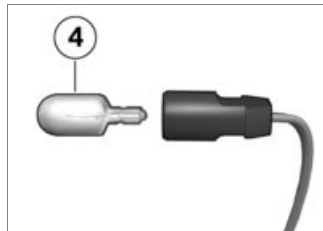

- Insert bulb **4** into the socket.

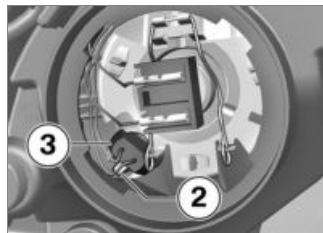

- Insert socket **3** into the headlight housing, making sure that retainer **2** engages.
- Install the cover.

## Replacing bulbs for front and rear turn indicators

- Make sure the ground is level and firm and place the motorcycle on its stand.
- Switch off the ignition.



- Remove screw **1**.



- Pull the glass out of the light housing at the threaded-fastener side.

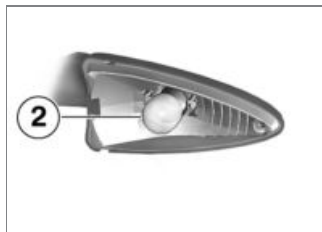

- Turn bulb **2** counter-clockwise and remove it from the light housing.

- Replace the defective bulb.

 Bulbs for flashing turn indicators, front

RY10W / 12 V / 10 W

– with LED turn indicators<sup>OE</sup>

LED<

 Bulbs for flashing turn indicators, rear

RY10W / 12 V / 10 W

– with LED turn indicators<sup>OE</sup>

LED<

- Use a clean, dry cloth to hold the bulb in order to keep the glass free of dirt and foreign matter.

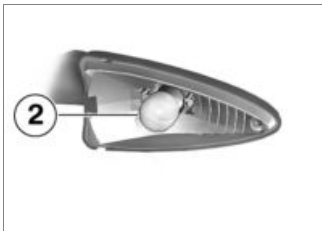

- Turn bulb **2** clockwise to install it in the bulb housing.



- Working from the inboard side, insert the glass into the light housing and close the housing.



- Install screw **1**.

### LED rear light

If LEDs in the rear light fail the rear light has to be replaced. Under these circumstances:

- Seek the advice of a specialist workshop, preferably an authorised BMW Motorrad dealer.

### Number plate light

If the LEDs for the number plate light in the rear light fail the rear light has to be replaced. Under these circumstances:

- Seek the advice of a specialist workshop, preferably an authorised BMW Motorrad dealer.

## Body panels

### Remove the side panel



#### NOTICE

The procedure described here for the right side apply applies by analogy to the left side panel. ◀

- Make sure the ground is level and firm and place the motorcycle on its stand.

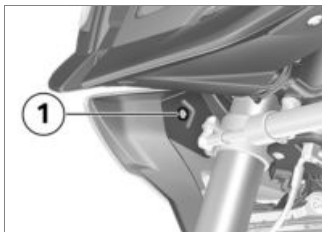

- Remove screw **1** from the in-board side of the side panel.

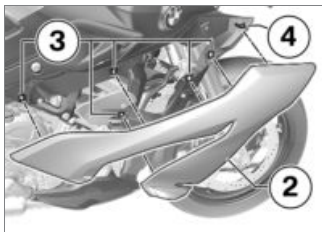

- Disengage fairing side panel **2** from slip-in retainers **3** and retaining clips **4**.
- Remove the side panel.

## Installing side panel

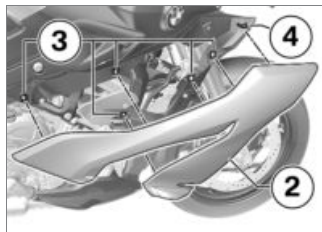

- Secure fairing top section **2** in retaining clips **4** and slip-in retainers **3**.

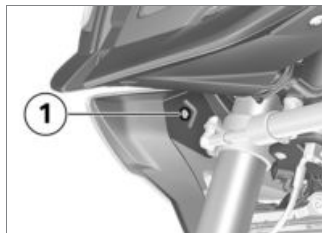

- Install screw **1**.

## Disengaging inner trim panel

- Make sure the ground is level and firm and place the motorcycle on its stand.

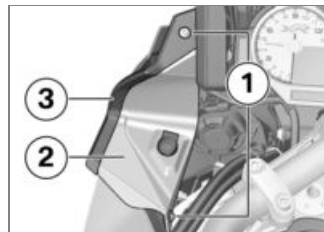

- Remove screws **1**.
- Work inner trim panel **2** out of fairing top section **3**.

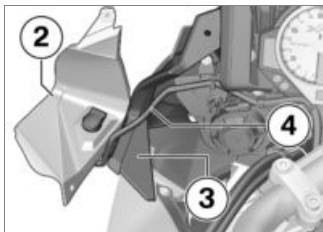

- Disengage inner trim panel **2**. In this process, take care not to strain cable **4** for the power socket.

## Installing inboard cover

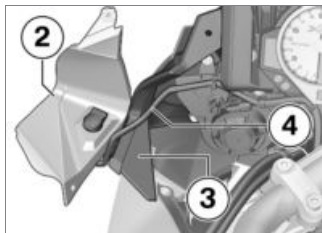

- Install inner trim panel **2**. In this process, note cable **4**.
- Align the inner trim panel and seat it in fairing top section **3**.

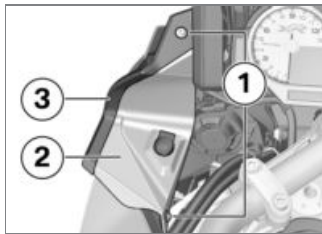

- Install screws **1**.

## Jump-starting

### CAUTION

**Touching live parts of the ignition system when the engine is running.**

Electric shock

- Do not touch parts of the ignition system when the engine is running. ◀

### ATTENTION

**Excessive current flowing when the motorcycle is jump-started**

Wiring smoulders/ignites or damage to the on-board electronics

- If the motorcycle has to be jump-started connect the leads to the battery terminals; never attempt to jump-start the engine by connecting leads to the on-board socket. ◀



## ATTENTION

### Contact between crocodile clips of jump leads and vehicle.

Risk of short-circuit

- Use jump leads fitted with fully insulated crocodile clips at both ends.◀



## ATTENTION

### Jump-starting with a voltage greater than 12 V.

Damage to the on-board electronics.

- Make sure that the battery of the donor vehicle has a voltage rating of 12 V.◀
- When jump-starting the engine, do not disconnect the battery from the on-board electrical system.
- Removing seat (▶▶▶ 62).

- Run the engine of the donor vehicle during jump-starting.
- Begin by connecting one end of the red jump lead to the positive terminal of the discharged battery and the other end to the positive terminal of the donor battery.
- Then connect one end of the black jump lead to the negative terminal of the donor battery, and the other end to the negative terminal of the discharged battery.
- Start the engine of the vehicle with the discharged battery in the usual way; if the engine does not start, wait a few minutes before repeating the attempt in order to protect the starter motor and the donor battery.
- Allow both engines to idle for a few minutes before disconnecting the jump leads.
- Disconnect the jump lead from the negative terminals first, then disconnect the second lead from the positive terminals.
- Installing seat (▶▶▶ 63).

## Battery

### Maintenance instructions

Correct upkeep, recharging and storage will prolong the life of the battery and are essential if warranty claims are to be considered.

Compliance with the points below is important in order to maximise battery life:

- Keep the surface of the battery clean and dry
- Do not open the battery
- Do not top up with water
- Be sure to read and comply with the instructions for charging the battery on the following pages

- Do not turn the battery upside down.



## ATTENTION

### On-board electronics (e.g. clock) draining connected battery.

Battery is deep-discharged; this voids the guarantee.

- Connect a float charger to the battery if the motorcycle is to remain out of use for more than four weeks.◀



## NOTICE

BMW Motorrad has developed a float charger specially designed for compatibility with the electronics of your motorcycle. Using this charger, you can keep the battery charged during long periods of disuse, without having to disconnect the battery from the motorcycle's on-board sys-

tems. You can obtain additional information from your authorised BMW Motorrad dealer.◀

### Charge battery when connected



## ATTENTION

### Charging connected battery via the battery terminals.

Damage to the on-board electronics.

- Disconnect the battery at the battery terminals before charging.◀



## ATTENTION

### Charging a fully discharged battery via the on-board socket or the extra socket.

Damage to the on-board electronics.

- If a battery has discharged to the extent that it is completely flat (battery voltage less than

9 V, status-indicator lights and multifunction display remain off when the ignition is switched on) **it has to be disconnected from the on-board circuits** and re-charged with the charger connected directly to the battery posts.◀



## ATTENTION

### Unsuitable battery chargers connected to an on-board socket.

Damage to charger and to frame and suspension electronics.

- Use suitable BMW chargers. The suitable charger is available from your authorised BMW Motorrad dealer.◀
- Charge via the charging socket, with the battery connected to the motorcycle's on-board electrical system.



## NOTICE

The motorcycle's on-board electronics know when the battery is fully charged. The on-board socket is switched off when this happens.◀

- Comply with the operating instructions of the charger.

## NOTICE

If you are unable to charge the battery through the on-board socket, you may be using a charger that is not compatible with your motorcycle's electronics. If this happens, disconnect the battery from the on-board systems and connect the charger directly to the battery.◀

## Charging battery when disconnected

- Disconnecting battery from motorcycle (▶ 159).

- Charge the battery using a suitable charger.
- Comply with the operating instructions of the charger.
- Once the battery is fully charged, disconnect the charger's terminal clips from the battery terminals.

## NOTICE

The battery has to be recharged at regular intervals in the course of a lengthy period of disuse. See the instructions for caring for your battery. Always fully recharge the battery before restoring it to use.◀

- Connecting battery to motorcycle (▶ 160).

## Disconnecting battery from motorcycle

- Make sure the ground is level and firm and place the motorcycle on its stand.

- Removing seat (▶▶ 62).

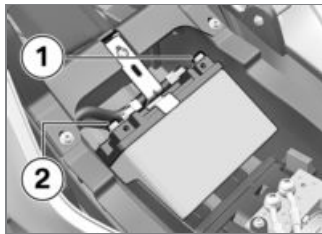

## ATTENTION

**Battery not disconnected in accordance with correct procedure.**

Risk of short-circuit

- Always proceed in compliance with the specified disconnection sequence.◀
- First disconnect battery negative lead **1**.
- Then disconnect battery positive lead **2**.

– with alarm system (DWA)<sup>OE</sup>

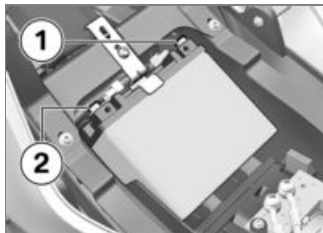

### ATTENTION

#### Battery not disconnected in accordance with correct procedure.

Risk of short-circuit

- Always proceed in compliance with the specified disconnection sequence. ◀
- First disconnect battery negative lead **1**.
- Then disconnect battery positive lead **2**. ◀

## Connecting battery to motorcycle

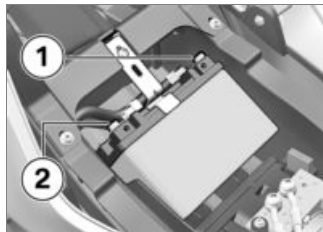

- Connect battery positive lead **2** first.
- Then install battery negative lead **1**.

– with alarm system (DWA)<sup>OE</sup>

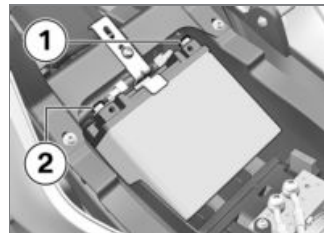

- Connect battery positive lead **2** first.
- Then install battery negative lead **1**. ◀
- Installing seat (▣▶ 63).

## Removing battery

- Removing seat (▣▶ 62).
- Disconnecting battery from motorcycle (▣▶ 159).

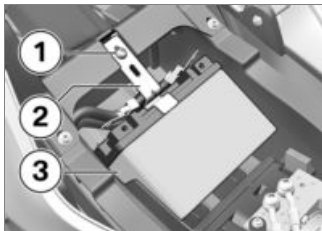

- Remove screw **1**.
- Remove bracket **2**.
- Lift battery **3** up and out; work it slightly back and forth if it is difficult to remove.

– with alarm system (DWA)<sup>OE</sup>

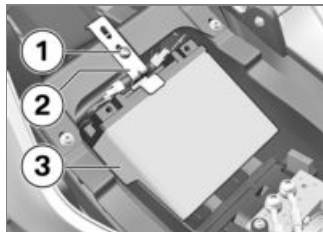

- Remove screw **1**.
- Remove bracket **2**.
- Lift battery **3** up and out; work it slightly back and forth if it is difficult to remove.◀

## Installing battery



### NOTICE

If the battery was disconnected from the motorcycle for a prolonged period of time it will be necessary to enter the current date in the instrument panel, in

order to ensure that the service-due indicator functions correctly. If you want to have the date set consult a specialist workshop, preferably an authorised BMW Motorrad dealer.◀

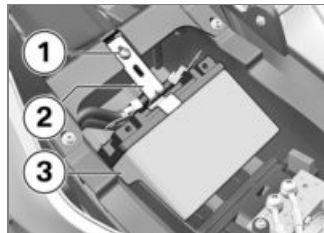

- Place battery **3** in the battery compartment, positive terminal on the right in the forward direction of travel.
- Install holder **2**.
- Install screw **1**.

– with alarm system (DWA)<sup>OE</sup>

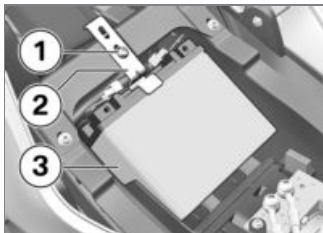

- Place battery **3** in the battery compartment, positive terminal on the right in the forward direction of travel.
- Install holder **2**.
- Install screw **1**.◀
- Connecting battery to motor-cycle (▣▣▣ 160).
- Installing seat (▣▣▣ 63).
- Setting the clock (▣▣▣ 52).

## Fuses

### Replace fuses



#### ATTENTION

#### Jumpering of blown fuses.

Risk of short-circuit and fire.

- Always replace a defective fuse with a new fuse of the same amperage.◀
- Switch off the ignition.
- Make sure the ground is level and firm and place the motor-cycle on its stand.
- Removing seat (▣▣▣ 62).

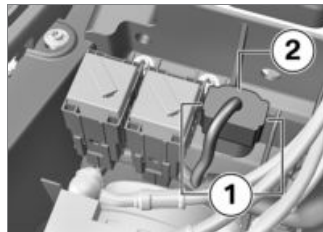

- Press latch **1** on both sides.
- Remove fuse box **2**.
- Consult the fuse assignment diagram below and replace the defective fuse.



#### NOTICE

If fuse defects recur frequently have the electric circuits checked by a specialist workshop, preferably an authorised BMW Motorrad dealer.◀

- Reinsert fuse box **2**. Make sure that latch **1** engages on both sides.
- Installing seat (▣▣▣ 63).

## Fuse assignment

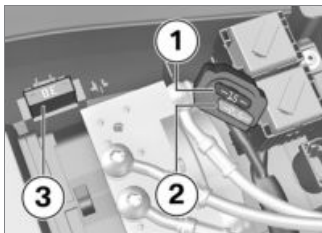

Retainer 1

15 A (Master relay, diagnosis plug, instrument cluster, anti-theft alarm, ignition switch)

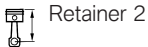

Retainer 2

7.5 A (Lap trigger, left multi-function switch, sensor box)



Retainer 3

30 A (BCO, controller, master relay)

## Chain

### Lubricating chain



#### ATTENTION

#### Inadequate cleaning and lubrication of the drive chain.

Accelerated wear.

- Clean and lubricate the drive chain at regular intervals. ◀
- Lubricate the drive chain every 800 km at the latest. Lubricate the chain more frequently if the motorcycle is ridden in wet, dusty or dirty conditions.
- Switch the ignition off and select neutral.

- Clean the drive chain with a suitable cleaning product, dry it and apply chain lubricant.
- To prolong chain life, BMW Motorrad recommends the use of BMW Motorrad chain lubricant, or:



Lubricant

Chain spray

- Wipe off excess lubricant.

### Checking chain tension

- Make sure the ground is level and firm and place the motorcycle on its stand.
- Turn the rear wheel until it reaches the position with the lowest amount of chain sag.

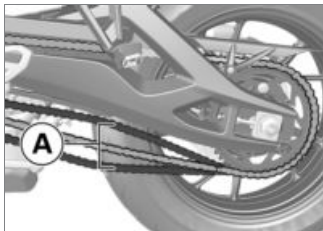

- Use a screwdriver to push the chain up and down at a point midway along the run between pinion and sprocket and measure chain deflection **A**.



Chain deflection

45...50 mm (Motorcycle with no weight applied, supported on its side stand)

– with lowered suspension<sup>OE</sup>

35...45 mm (Motorcycle with no weight applied, supported on its side stand)<

If chain deflection is outside permitted tolerance:

- Adjust the chain tension (▮▮▮▮▶ 164).

### Adjust the chain tension

- Make sure the ground is level and firm and place the motorcycle on its stand.

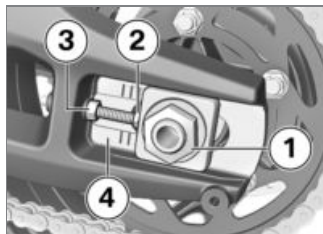

- Slacken nut **1**.
- Slacken locknuts **3** on left and right.
- Use adjusting screws **2** on left and right to adjust chain tension.

- Checking chain tension (▮▮▮▶ 163).
- Make sure that scale readings **4** are the same on left and right.
- Tighten locknuts **3** on left and right to the specified tightening torque.



Locknut of the final-drive chain tensioning screw

19 Nm

- Tighten nut **1** to the specified tightening torque.



Rear quick-release axle in swinging arm

Thread-locking compound: mechanical

100 Nm

### Checking the chain wear

- Engage 1st gear.

- Turn the rear wheel in the normal direction of travel until the chain is tensioned.
- Measure chain length underneath the rear wheel swinging arm.

If the chain has stretched to the maximum permissible length:

- Seek the advice of a specialist workshop, preferably an authorised BMW Motorrad dealer.

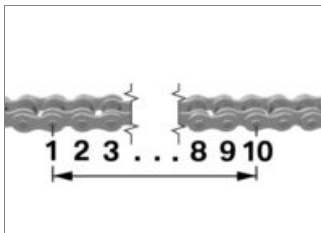

Permissible chain length

max 144.30 mm (measured  
**centre to centre** over 10  
 pins, chain pulled taut)





## Accessories

General instructions.....	168
Power sockets .....	168
Cases.....	169
Topcase .....	172
Navigation system .....	174
Socket for optional accessories ....	179

## General instructions

### CAUTION

#### Use of other-make products.

Safety risk

- BMW Motorrad cannot examine or test each product of outside origin to ensure that it can be used on or in connection with BMW vehicles without constituting a safety hazard. Country-specific official authorisation does not suffice as assurance. Tests conducted by these instances cannot make provision for all operating conditions experienced by BMW vehicles and, consequently, they are not sufficient in some circumstances.
- Use only parts and accessories approved by BMW for your vehicle. ◀

BMW has conducted extensive testing of the parts and ac-

cessory products to establish that they are safe, functional and suitable. Consequently, BMW accepts product liability. BMW accepts no liability whatsoever for parts and accessories that it has not approved.

Whenever you are planning modifications, comply with all the legal requirements. Make sure that the vehicle does not infringe the national road-vehicle construction and use regulations applicable in your country. Your BMW Motorrad dealer can offer expert advice on the choice of genuine BMW parts, accessories and other products. To find out more about accessories go to:

**[bmw-motorrad.com/  
accessories](http://bmw-motorrad.com/accessories)**

## Power sockets

### Connection of electrical devices

- You can start using electrical devices connected to the motorcycle's sockets only when the ignition is switched on.

### Cable routing

- The cables from the power sockets to the auxiliary devices must be routed in such a way that they do not impede the rider.
- The cable routing should not restrict the steering angle or obstruct handling.
- The cables must not be trapped.

### Automatic shutdown

- The sockets will be automatically switched off during the start procedure.

- The power supply to the sockets is switched off no more than 15 minutes after the ignition is switched off, in order to prevent overloading of the on-board electrics. Low-wattage electrical accessories might not be recognised by the vehicle's electronics. In such cases, power sockets are switched off very shortly after the ignition is turned off.
- If the battery charge state is too low to maintain the motorcycle's start capability, the power sockets are switched off.
- The power sockets are also switched off when the maximum load capability as stated in the technical data is exceeded.

## Cases

### Open cases

- with case holders left / right<sup>OE</sup>

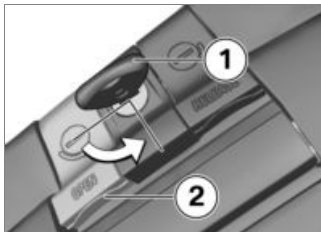

- Turn the key **1** to position OPEN.
- Pull the grey release lever **2** (OPEN) all the way up and simultaneously open the case lid.

### Closing cases

- with case holders left / right<sup>OE</sup>

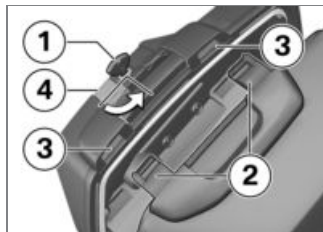

- Turn the key **1** to position OPEN.
- Press catches **2** of the case lid into retainers **3**. Check that nothing is trapped between the lid and the case.
- Pull the grey release lever **4** (OPEN) all the way up and simultaneously open the case lid.
  - » The lid engages with an audible click.
- Turn key **1** in the case lock to the position in which it is parallel with the direction of travel and remove the key.

## Removing cases

– with case holders left / right<sup>OE</sup>

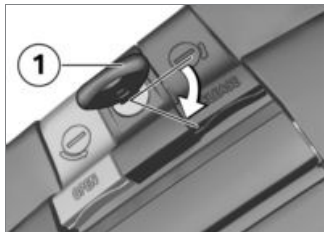

- Turn the key **1** to position RELEASE.



- Pull the black release lever **1** (RELEASE) up and simultaneously pull the case out.
- Then lift the case out of the bottom holder.

## Install cases

– with case holders left / right<sup>OE</sup>

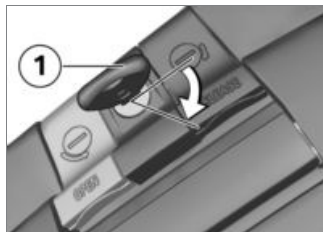

- Turn the key **1** to position RELEASE.

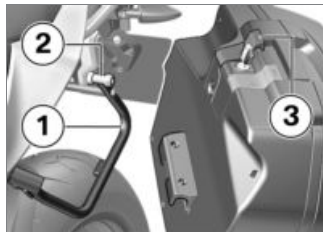

- Position the case in case holder **1**, then pivot it until it is seated at mount **2**.
- Pull the black release lever **3** (RELEASE) up and simultan-

ously push the case into the upper holder **2**.



- Push black release lever **3** (RELEASE) down until it engages.
- Turn the key in the case lock to the position in which it is parallel with the direction of travel and remove the key.

## Maximum payload and maximum permissible speed

Note the maximum permissible payload and the speed limit for riding with cases fitted, as stated on the label inside the case.

Contact your authorised BMW Motorrad dealer if you cannot find your combination of vehicle and cases on the label.

The values for the combination described here are as follows:

 Maximum permissible speed for riding with cases fitted to the motorcycle
max 180 km/h
 Payload per case
max 10 kg

## Secure attachment

– with case holders left / right <sup>OE</sup>

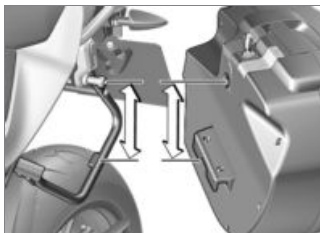

If a case wobbles or is difficult to fit, it has to be adapted to the

gap between the top and bottom holders.

## **WARNING**

**Case installation not in compliance with correct procedure.**

Impairment of road safety.

- Cases may not wobble and must be secured free from play. Re-adjust the retainer if play develops over the course of time. ◀



Screws **1** inside the case allow you to make this adjustment.

## Topcase

### Opening topcase

– with luggage carrier<sup>OE</sup>



- Turn the key in the topcase lock to position **1**.



- Push lock barrel **1** forward.  
» Lever **2** pops up.
- Pull the release lever all the way up.

» The lid of the topcase opens.

### Closing topcase

– with luggage carrier<sup>OE</sup>



- Pull release lever **1** all the way up.
- Close the lid of the topcase and hold it down. Check that nothing is trapped between the lid and the case.



### NOTICE

The topcase can also be locked by turning the lock to the LOCK position. In this case, make sure

that the key is not left inside the topcase. ◀



- Push release lever **1** down until it engages.
- Turn the key in the topcase lock to the LOCK position and remove the key from the lock.

### Removing the topcase

– with luggage carrier<sup>OE</sup>



- Turn the key in the topcase lock to position **1**.  
» The handle pops out.



- Pull handle **1** up as far as it will go.

- Lift the topcase at the rear and remove it from the luggage carrier.

### Installing topcase

– with luggage carrier<sup>OE</sup>

#### **WARNING**

**Topcase securing not in compliance with correct procedure.**

Impairment of road safety.

- The topcase may not wobble and must be secured free from play. ◀



- Pull handle **1** up as far as it will go.



- Hook the topcase into position on the luggage carrier. Make sure that hooks **2** are securely

seated in the corresponding keepers **3**.

- Push handle **1** down until it engages.





- Turn the key in the topcase lock to position **1** and remove the key from the lock.

### Maximum payload and maximum permissible speed

Note the maximum permissible payload and the speed limit for riding with topcase fitted, as stated on the label inside the topcase.

Contact your authorised BMW Motorrad dealer if you cannot find your combination of vehicle and topcase on the label. The values for the combination described here are as follows:

	Maximum permissible speed for riding with topcase fitted to the vehicle
max 180 km/h	
	Payload of topcase
max 5 kg	

### Navigation system Installing navigation device

- with preparation for navigation system<sup>OE</sup>
- with navigation system<sup>OA</sup>



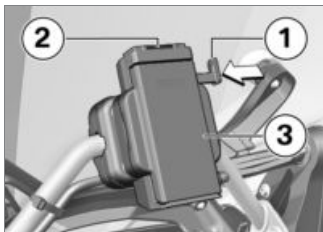

- Press latch **1**.  
» Mark **2** indicates that latch is released.
- Remove cover **3**.

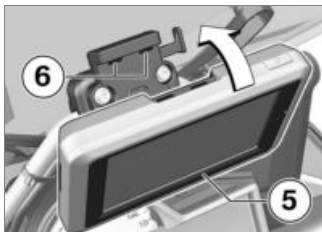

- Pivot navigation device **5** forward and at the top edge, press it into latching mechanism **6**.  
» The navigation device engages.
- Check that the navigation device is secure in the cradle. Check that red mark **2** is no longer visible.

### Removing navigation device

- with preparation for navigation system<sup>OE</sup>
- with navigation system<sup>OA</sup>

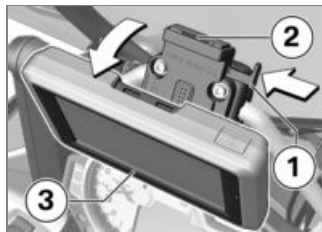

- Press latch **1**.  
» Mark **2** indicates that latch is released.
- Remove navigation device **3**.



- Set the navigation device in cradle **4**.



- Set the cover in cradle **4**.

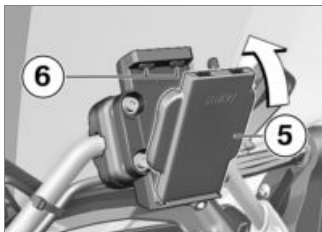

- Pivot cover **5** forward and at the top edge, press it into latching mechanism **6**.
- » The cover engages.
- Check that the cover is secure in the cradle. Check that mark **2** is no longer visible.

## Operating navigation system

- with preparation for navigation system<sup>OE</sup>

- with navigation system<sup>OA</sup>



### NOTICE

The description below is based on the Navigator V. The Navigator IV does not support all the possibilities described here. ◀



### NOTICE

Only the latest version of the BMW Motorrad communication system is supported. A software update of the BMW Motorrad communication system may be necessary. If this is the case, consult your authorised BMW Motorrad dealer. ◀

If the BMW Motorrad Navigator is fitted, some of its functions can be controlled directly from the handlebars using the Multi-Controller.



The Multi-Controller is operated by means of six movements:

- Turning upwards and downwards.
- Short operation to the left and right.
- Extended operation to the left and right.

Turning the Multi-Controller with the Compass or Mediaplayer page open increases or decreases the volume of a BMW Motorrad communication system connected via Bluetooth.

In the BMW special menu, the menu items are selected by turning the Multi-Controller.

Short operation of the Multi-Controller to the left or right changes between the main pages of the Navigator:

- Map view
- Compass
- Mediaplayer
- BMW special menu
- My Motorcycle page

Long-pushing the Multi-Controller corresponds to activating certain functions on the Navigator display. An arrow to the right or to the left above the corresponding button area on the display indicates a function that can be activated in this way.

 Long-push to the right to activate this function.

 Long-push to the left to activate this function.

In detail, the following functions can be controlled:

### **Map view**

- Turn up: **Zoom in.**
- Turn down: **Zoom out.**

### **Compass page**

- Turning increases or decreases the volume of a BMW Motorrad communication system connected via Bluetooth.

### **BMW special menu**

- Speak: Repeat most recent navigation announcement.
- Waypoint: Save current location as a favourite.
- Home: Starts navigation to home address (greyed if no home address has been defined).

- Mute: Switch automatic navigation announcements off or on (off: a crossed-out lips symbol appears in the top line of the display). "Speak" will still activate navigation announcements. All other acoustic outputs remain switched on.
- Switch off display: Deactivate the display.
- Dial home number: Dials the home phone number saved in the Navigator (not shown unless a telephone is connected).
- Diversion: Activates the diversion function (not shown unless a route is active).
- Skip: Skips the next waypoint (not shown unless the route has waypoints).

### **My Motorcycle**

- Turn: Changes the number of data shown.

- Touch a data field on the display to open the menu for selecting data.
- The values available for selection depend on the optional extras installed on the vehicle.

**NOTICE**

The Mediaplayer function is available only with a Bluetooth device supporting the A2DP standard, for example a BMW Motorrad communication system. ◀

**Mediaplayer**

- Long-push to the left: Play preceding track.
- Long-push to the right: Play next track.
- Turning increases or decreases the volume of a BMW Motorrad communication system connected via Bluetooth.

**Warnings and status messages**



Warning and status messages from the motorcycle are indicated by a symbol **1** appearing at the top left in the map view.

**NOTICE**

If a BMW Motorrad communication system is connected, warnings are accompanied by an acoustic signal. ◀

If there are two or more active warnings the number appears below the warning triangle.

Touching the warning triangle when more than one warning is active opens a list of all the warnings. Additional information appears as soon as a message is selected.

**NOTICE**

Detailed information cannot be displayed for all warnings. ◀

**Special functions**

Integration of the BMW Motorrad Navigator has produced a number of deviations from the descriptions in the operating instructions for the Navigator.

**Reserve fuel level warning**

The settings for the fuel gauge are not available, because the reserve fuel level warning is sent by the vehicle to the Navigator. Touch the message when it is active to view the locations of the nearest filling stations.

## Time and date

The Navigator sends the time and date to the motorcycle. The transfer of these data into the instrument cluster must be activated in the **SETUP** menu of the instrument cluster.

## Security settings

The BMW Motorrad Navigator V can be secured against unauthorised use with a four-digit PIN (Garmin Lock). If this function is activated, while the Navigator is cradled on the motorcycle and the ignition is switched on you are prompted to add the motorcycle to the list of secured vehicles. If you answer "Yes" at this prompt the Navigator saves the VIN of this vehicle in its internal memory.

A maximum of five VINs can be saved in this way.

Subsequently, the PIN does not have to be entered when the

Navigator is switched on by ignition ON while cradled in any of these vehicles.

If the Navigator is removed from the vehicle while switched on, a security prompt asking for the PIN to be entered is issued.

## Screen brightness

Screen brightness is adjusted by the motorcycle while the unit is cradled. No manual input is necessary.

If you prefer, you can switch off automatic adjustment in the Navigator display settings.

## Socket for optional accessories

### Equipment

The vehicle is fitted with the following plugs for optional accessories and racing accessories:

- Infrared receiver
- Spring-travel sensor
- Optional accessory
- HP Race data logger

## Underneath the right side panel



- 1 Plug for infrared receiver

## Underneath the left side panel



- 1 Plug for optional accessories and racing accessories  
Voltage supply and LIN  
Spring travel sensor for front forks (racing accessory)  
– with preparation for navigation system<sup>OE</sup>  
Navigation system

## Underneath the seat

– with alarm system (DWA)<sup>OE</sup>

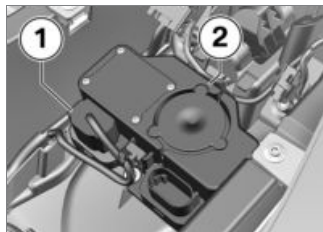

- 1 Plug for DWA and HP Race data logger
- 2 DWA

## Underneath the seat

– without alarm system (DWA)<sup>OE</sup>

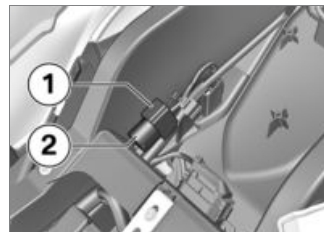

- 1 Plug for DWA and HP Race data logger
- 2 Terminating resistor

## Underneath the rear carrier

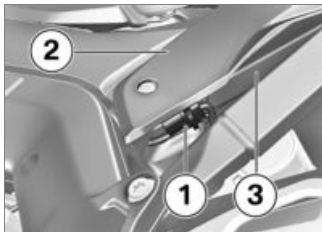

- 1** Plug for rear additional power socket

### NOTICE

The plug for extra socket **1** is behind rear trim panel **2**, tied back to inner frame **3**. ◀

## Connecting optional accessories and racing accessories

Remove the side panel, rear seat or tail-hump cover, as applicable, to gain access to the plugs.

- Remove the side panel (▶▶▶ 154).
- Removing seat (▶▶▶ 62).
- Unlock the protective cap or terminating resistor, as applicable, and disconnect it from the plug.
- Connect the optional accessory or racing accessory, as applicable.

### NOTICE

Comply with the installation instructions supplied with the optional accessory or racing accessory. ◀

### NOTICE

Tightening the cable ties has to be the last step in the process; this is in order to ensure that the wiring harness can be positioned correctly and that there is no strain on the cable legs with plugs. ◀

### ATTENTION

#### **Dirt and damp penetrating inside open connectors.**

Malfunctions

- Reinstall the cap or terminating resistor, as applicable, after removing the plug. ◀
- After removing the accessory: Reinstall the cap or terminating resistor, as applicable.
- Installing side panel (▶▶▶ 155).
- Installing seat (▶▶▶ 63).





## Care

Care products .....	184
Washing the vehicle .....	184
Cleaning easily damaged components.....	185
Paint .....	185
Laying up the motorcycle .....	186
Preserving paintwork.....	186
Restoring motorcycle to use .....	186

## Care products

BMW Motorrad recommends that you use the cleaning and care products you can obtain from your authorised BMW Motorrad dealer.

The substances in BMW CareProducts have been tested in laboratories and in practice; they provide optimised care and protection for the materials used in your vehicle.



### ATTENTION

#### Use of unsuitable cleaning and care products.

Damage to vehicle parts.

- Do not use solvents such as cellulose thinners, cold cleaners, fuel or the like, and do not use cleaning products that contain alcohol.◀

## Washing the vehicle

BMW Motorrad recommends that you use BMW insect remover to soften and wash off insects and stubborn dirt on painted parts prior to washing the motorcycle.

To prevent stains, do not wash the vehicle immediately after it has been exposed to strong sunlight and do not wash it in the sun.

Make sure that the vehicle is washed frequently, especially during the winter months.

To remove road salt, clean the motorcycle with cold water immediately after every trip.



### WARNING

#### Wet brake discs and brake pads after vehicle wash, after riding through water and in rainy conditions.

Diminished braking effect.

- Apply the brakes in good time to allow the friction and heat to dry the brake discs and brake pads.◀



### ATTENTION

#### Effect of road salt intensified by warm water.

Corrosion

- Use only cold water to wash off road salt.◀



### ATTENTION

#### Damage due to high water pressure from high pressure cleaners or steam cleaners.

Corrosion or short-circuit, damage to seals, to the hydraulic brake system, to the electrics and the seat.

- Exercise restraint when using a steam jet or high-pressure cleaning equipment.◀

## Cleaning easily damaged components

### Plastics

#### ATTENTION

#### Use of unsuitable cleaning agents.

Damage to plastic surfaces.

- Do not use cleaning agents that contain alcohol, solvents or abrasives.
- Do not use insect-remover pads or cleaning pads with hard, scouring surfaces.◀

#### Body panels

Clean the trim panels with water and BMW plastic care emulsion.

#### Windscreens and lenses made of plastic

Clean off dirt and insects with a soft sponge and plenty of water.

#### NOTICE

Soften stubborn dirt and insects by covering the affected areas with a wet cloth.◀

#### Chrome

Use plenty of water and BMW shampoo to clean chrome, particularly if it has been exposed to road salt. Use chrome polish for additional treatment.

#### Radiator

Clean the radiator regularly to prevent overheating of the engine due to inadequate cooling. For example, use a garden hose with low water pressure.

#### ATTENTION

#### Radiator fins easily bent.

Damage to radiator fins.

- Take care not to bend the radiator fins when cleaning.◀

### Rubber

Treat rubber components with water or BMW rubber-care products.

#### ATTENTION

#### Application of silicone sprays to rubber seals.

Damage to the rubber seals.

- Do not use silicone sprays or care products that contain silicon.◀

### Paint

Washing the vehicle regularly will help counteract the long-term effects of substances that damage the paint, especially if your vehicle is ridden in areas with high air pollution or natural sources of dirt, for example tree resin or pollen.

Remove particularly aggressive substances immediately, however, as otherwise the paint can

be affected or become discoloured. Substances of this nature include spilt fuel, oil, grease, brake fluid and bird droppings. We recommend BMW vehicle polish or BMW paint cleaner for this purpose.

Marks on the paintwork are particularly easy to see after the vehicle has been washed. Remove stains of this kind immediately, using cleaning-grade benzene or petroleum spirit on a clean cloth or ball of cotton wool. BMW Motorrad recommends BMW tar remover for removing specks of tar. Remember to wax the parts treated in this way.

## Laying up the motorcycle

- Clean the motorcycle.
- Fill the motorcycle's fuel tank.
- Removing battery (▣▣▣▶ 160).

- Spray the brake and clutch lever pivots and the main and side stand pivots with a suitable lubricant.
- Coat bright metal and chrome-plated parts with an acid-free grease (e.g. Vaseline).
- Stand the motorcycle in a dry room in such a way that there is no load on either wheel (preferably using the front-wheel and rear-wheel stands from BMW Motorrad).

## Preserving paintwork

BMW Motorrad recommends applying only BMW car wax or products containing carnauba wax or synthetic wax to preserve the paintwork.

It is time to rewax the paintwork when water "puddles" on the surface, instead of forming beads.

## Restoring motorcycle to use

- Remove the protective wax coating.
- Clean the motorcycle.
- Installing battery (▣▣▣▶ 161).
- Comply with checklist (▣▣▶ 99).

## Technical data

Troubleshooting chart .....	188
Threaded fasteners .....	189
Fuel.....	191
Engine oil .....	191
Engine .....	192
Clutch .....	193
Transmission .....	193
Rear-wheel drive.....	194
Frame .....	194
Running gear .....	195
Brakes .....	196
Wheels and tyres .....	196
Electrics .....	198
Dimensions .....	199
Weights.....	200

Riding specifications .....	200
-----------------------------	-----

## Troubleshooting chart

Engine does not start or is difficult to start.

<b>Possible cause</b>	<b>Rectification</b>
Side stand extended and gear engaged	Retract the side stand.
Gear engaged and clutch not disengaged	Select neutral or pull the clutch lever.
No fuel in tank	Refuelling (▮▮▮▶ 109).
Battery flat	Charge battery when connected (▮▮▮▶ 158).

## Threaded fasteners

Front wheel	FR	Valid
<b>Screw in front-wheel quick-release axle</b>		
M20 x 1.5	50 Nm	
<b>Clamping screws in axle holder</b>		
M8 x 35	<b>Tighten screws six times in alternate sequence</b>	
	19 Nm	
<b>Radial brake caliper to axle mount</b>		
M10 x 65	38 Nm	
<b>Wheel-speed sensor to fork leg</b>		
M6 x 16 Micro-encapsulated or medium-strength thread-locking compound	8 Nm	
<b>Rear wheel</b>	<b>FR</b>	<b>Valid</b>
<b>Locknut of the final-drive chain tensioning screw</b>		
M8	19 Nm	

<b>Rear wheel</b>	<b>FR</b>	<b>Valid</b>
<b>Rear quick-release axle in swinging arm</b>		
M24 x 1.5 mechanical	100 Nm	
<b>Swinging-arm adapter to rear wheel swinging arm</b>		
M8 x 40	20 Nm	
<b>Screw in adjusting ring</b>		
M5 x 25	3 Nm	- without Dynamic ESA <sup>OE</sup>
<b>Mirrors</b>	<b>FR</b>	<b>Valid</b>
<b>Mirror (lock nut) to adapter</b>		
Left-hand thread, M10 x 1.25	22 Nm	





## Engine

Engine design	Water-/oil-cooled four-cylinder four-stroke inline engine, four valves per cylinder, two overhead camshafts
Displacement	999 cm <sup>3</sup>
Cylinder bore	80 mm
Piston stroke	49.7 mm
Compression ratio	12 : 1
Nominal output	118 kW, at engine speed: 11000 min <sup>-1</sup>
– with power reduction <sup>OE</sup>	79 kW, at engine speed: 7500 min <sup>-1</sup>
Torque	112 Nm, at engine speed: 9250 min <sup>-1</sup>
– with power reduction <sup>OE</sup>	103 Nm, at engine speed: 7000 min <sup>-1</sup>
Maximum engine speed	max 12000 min <sup>-1</sup>
Idle speed	1250 min <sup>-1</sup> , Engine at regular operating temperature

## Clutch

Clutch type	Multiplate oil-bath clutch, anti-hopping
-------------	--

## Transmission

Gearbox type	Claw-shift 6-speed gearbox, integrated into engine block
Gearbox transmission ratios	1.652 (76/46 teeth), Primary transmission ratio 2.647 (45/17 teeth), 1st gear 2.091 (46:22 teeth), 2nd gear 1.727 (38:22 teeth), 3rd gear 1.500 (33:22 teeth), 4th gear 1.360 (34:25 teeth), 5th gear 1.261 (29:23 teeth), 6th gear

## Rear-wheel drive

Type of final drive	Chain drive
Type of rear suspension	Aluminium double swinging arm
Final drive, number of teeth (Pinion / sprocket)	17/45
Secondary transmission ratio	2.647

## Frame

Frame type	Aluminium composite bridge frame, load-bearing engine
Type plate location	Frame, front right, on steering head
Position of the Vehicle Identification Number	Frame, front right, on steering head

## Running gear

### Front wheel

Type of front suspension	Upside-down telescopic fork
Spring travel, front	150 mm, at front wheel
– with lowered suspension <sup>OE</sup>	120 mm, at front wheel

### Rear wheel

Type of rear suspension	Aluminium double swinging arm
Type of final drive	Chain drive
Spring travel, rear	140 mm, at rear wheel
– with lowered suspension <sup>OE</sup>	110 mm, at rear wheel

## Brakes

Type of front brake	Hydraulically radially operated twin disc brake with 4-piston radial fixed calipers and floating brake discs
Brake-pad material, front	Sintered metal
Type of rear brake	Hydraulically actuated disc brake with 2-piston floating caliper and fixed disc
Brake-pad material, rear	Organic material

## Wheels and tyres

Recommended tyre sets	Your authorised BMW Motorrad dealer will be happy to supply an up-to-date list of the approved wheel/tyre combinations, or you can check the information posted on the <a href="http://bmw-motorrad.com">bmw-motorrad.com</a> website.
Speed category, front/rear tyres	W, required at least: 270 km/h

**Front wheel**

Front wheel type	Aluminium cast wheel
Front wheel rim size	3.50" x 17"
Tyre designation, front	120/70 ZR 17
Load index, front tyre	min. 56
– with power reduction <sup>OE</sup>	min. 48
Permissible front-wheel imbalance	max 5 g

**Rear wheel**

Rear-wheel type	Aluminium cast wheel
Rear wheel rim size	6.0" x 17"
Tyre designation, rear	190/55 ZR 17
Load index, rear tyre	min. 73
– with power reduction <sup>OE</sup>	min. 66
Permissible rear-wheel imbalance	max 45 g

**Tyre pressure**

Tyre pressure, front	2.5 bar
Tyre pressure, rear	2.9 bar

## Electrics

### Fuses

Retainer 1	15 A, Master relay, diagnosis plug, instrument cluster, anti-theft alarm, ignition switch
Retainer 2	7.5 A, Lap trigger, left multifunction switch, sensor box
Retainer 3	30 A, BCO, controller, master relay

### Battery

Battery type	AGM
Battery rated voltage	12 V
Battery rated capacity	8 Ah
– with alarm system (DWA) <sup>OE</sup>	10 Ah

### Spark plugs

Spark plugs, manufacturer and designation	NGK LMAR9D-J
Electrode gap of spark plug	0.8 mm

### Lighting

Bulb for high-beam headlight	H7 / 12 V / 55 W
Bulbs for the low-beam headlight	H7 / 12 V / 55 W
Bulb for parking light	W3W / 12 V / 3 W



Bulb for tail light/brake light	LED
Bulb for number-plate light	Integrated in rear light
Maximum number of defective LEDs in rear-light unit	1
Bulbs for flashing turn indicators, front	RY10W / 12 V / 10 W
– with LED turn indicators <sup>OE</sup>	LED
Bulbs for flashing turn indicators, rear	RY10W / 12 V / 10 W
– with LED turn indicators <sup>OE</sup>	LED

## Dimensions

Length of motorcycle	2183 mm, measured over number-plate carrier
Height of motorcycle	max 1400 mm, measured to top of windscreen in lowest position, at DIN unladen weight
– with lowered suspension <sup>OE</sup>	max 1363 mm, measured to top of windscreen in lowest position, at DIN unladen weight
Width of motorcycle	890 mm, without mounted parts 940 mm, with mirrors
Front-seat height	840 mm, without rider at unladen weight
– with front seat, low <sup>OE</sup>	820 mm, without rider at unladen weight
– with lowered suspension <sup>OE</sup>	790 mm, without rider at unladen weight

Rider's inside-leg arc, heel to heel	1894 mm, without rider at unladen weight
– with front seat, low <sup>OE</sup>	1859 mm, without rider at unladen weight
– with lowered suspension <sup>OE</sup>	1790 mm, without rider at unladen weight

## Weights

Unladen weight	228 kg, DIN unladen weight, ready for road, 90 % load of fuel, without optional extras (OE)
Permissible gross weight	434 kg
Maximum payload	206 kg

## Riding specifications

Top speed	approx. 250 km/h
– with power reduction <sup>OE</sup>	approx. 211 km/h

## **Service**

BMW Motorrad Service .....	202
BMW Motorrad Mobility services .....	202
Maintenance work .....	202
Maintenance schedule .....	205
Standard BMW service .....	206
Confirmation of maintenance work .....	207
Confirmation of service .....	212

## BMW Motorrad Service

BMW Motorrad has an extensive network of dealerships in place to look after you and your motorcycle in more than 100 countries. Authorised BMW Motorrad dealerships have the technical information and the technical know-how to carry out reliably all maintenance and repair work on your BMW.

You can locate your nearest authorised BMW Motorrad dealership by visiting our website:

**[bmw-motorrad.com](http://bmw-motorrad.com)**



### WARNING

#### **Maintenance and repair work not in compliance with correct procedure.**

Risk of accident due to subsequent damage.

- BMW Motorrad recommends you to have all the associated work on your motorcycle car-

ried out by a specialist workshop, preferably an authorised BMW Motorrad dealer. ◀

In order to help ensure that your BMW is always in optimum condition, BMW Motorrad recommends compliance with the maintenance intervals specified for your motorcycle. Have all maintenance and repair work that is carried out confirmed in the "Service" chapter in this manual. For generous treatment of claims submitted after the warranty period has expired, evidence of regular maintenance is essential.

Your authorised BMW Motorrad dealer can provide information on BMW services and the work undertaken as part of each service.

## BMW Motorrad Mobility services

As owner of a new BMW vehicle, in circumstances in which assistance is required you can benefit from the protection afforded by the various BMW Motorrad mobility services (e.g. Mobile Service, breakdown service, vehicle recovery service). Your authorised BMW Motorrad dealer will be happy to provide information about the mobility services available to you.

### Maintenance work

#### **BMW pre-delivery check**

Your authorised BMW Motorrad dealer conducts the BMW pre-delivery check before handing over the vehicle to you.

## BMW Running-in check



Mileage until the running-in check

500...1200 km

## BMW Service

The BMW Service is carried out once a year; the extent of servicing can vary, depending on the age of the vehicle and the distance it has covered. Your authorised BMW Motorrad dealer confirms that the service work has been carried out and enters the date when the next service will be due.

Riders who cover long distances in a year might have to bring in their vehicles for service before the next scheduled date. It is to allow for these cases that a maximum odometer reading is entered as well in the confirmation of service. Servicing has to be brought forward if this odo-

meter reading is reached before the next scheduled date for the service.

The service-due indicator in the multifunction display reminds you about one month or 1000 km in advance when the time for a service is approaching, on the basis of the programmed values.

To find out more about service go to:

**[bmw-motorrad.com/service](http://bmw-motorrad.com/service)**

The maintenance tasks necessary for your vehicle are set out in the maintenance schedule below:



## Maintenance schedule

- 1** BMW Running-in check
- 2** Standard BMW service  
( 206)
- 3** Engine-oil change, with filter
- 4** Check valve clearance
- 5** Checking timing
- 6** Replace all spark plugs
- 7** Replacing air filter
- 8** Oil change in the telescopic forks
- 9** Change brake fluid, entire system
  - a** annually or every 10,000 km (whichever comes first)
  - b** for the first time after one year, then every two years

## Standard BMW service

A standard BMW service consists of the following maintenance work:

- Perform vehicle test with the BMW Motorrad diagnosis system.
- Visually inspect the brake pipes, brake hoses and connections.
- Check the front and rear brake-fluid levels.
- Check the front and rear brake pads and brake discs for wear.
- Check the steering-head bearing.
- Check the coolant level.
- Check the fastener of the clutch lever fitting.
- Check the clutch cable and clutch-lever play.
- Lubricate the clutch mechanism.
- Check the drive chain, sprocket and pinion.
- Check the tyre pressures and tread depth.
- Check the ease of movement of the side stand.
- Lubricate the side stand.
- Check the lights and signalling equipment.
- Check that the engine start suppression system is in working order.
- Perform final inspection and check of roadworthiness.
- Set the service-due date and service countdown distance.
- Check the battery charge state.
- Confirm BMW service in the on-board documentation.



## Confirmation of maintenance work

### **BMW Pre-delivery Check**

Completed

on \_\_\_\_\_

\_\_\_\_\_  
Stamp, signature

### **BMW Running-in Check**

Completed

on \_\_\_\_\_

Odometer reading \_\_\_\_\_

Next service  
at the latest

on \_\_\_\_\_

or, if logged beforehand,

Odometer reading \_\_\_\_\_

\_\_\_\_\_  
Stamp, signature

**BMW Service**

Completed

on \_\_\_\_\_

Odometer reading \_\_\_\_\_

Next service  
at the latest

on \_\_\_\_\_

or, if logged beforehand,

Odometer reading \_\_\_\_\_

\_\_\_\_\_  
Stamp, signature**BMW Service**

Completed

on \_\_\_\_\_

Odometer reading \_\_\_\_\_

Next service  
at the latest

on \_\_\_\_\_

or, if logged beforehand,

Odometer reading \_\_\_\_\_

\_\_\_\_\_  
Stamp, signature**BMW Service**

Completed

on \_\_\_\_\_

Odometer reading \_\_\_\_\_

Next service  
at the latest

on \_\_\_\_\_

or, if logged beforehand,

Odometer reading \_\_\_\_\_

\_\_\_\_\_  
Stamp, signature

**BMW Service**

Completed

on \_\_\_\_\_

Odometer reading \_\_\_\_\_

Next service  
at the latest

on \_\_\_\_\_

or, if logged beforehand,

Odometer reading \_\_\_\_\_

\_\_\_\_\_  
Stamp, signature**BMW Service**

Completed

on \_\_\_\_\_

Odometer reading \_\_\_\_\_

Next service  
at the latest

on \_\_\_\_\_

or, if logged beforehand,

Odometer reading \_\_\_\_\_

\_\_\_\_\_  
Stamp, signature**BMW Service**

Completed

on \_\_\_\_\_

Odometer reading \_\_\_\_\_

Next service  
at the latest

on \_\_\_\_\_

or, if logged beforehand,

Odometer reading \_\_\_\_\_

\_\_\_\_\_  
Stamp, signature

**BMW Service**

Completed

on \_\_\_\_\_

Odometer reading \_\_\_\_\_

Next service  
at the latest

on \_\_\_\_\_

or, if logged beforehand,

Odometer reading \_\_\_\_\_

\_\_\_\_\_  
Stamp, signature**BMW Service**

Completed

on \_\_\_\_\_

Odometer reading \_\_\_\_\_

Next service  
at the latest

on \_\_\_\_\_

or, if logged beforehand,

Odometer reading \_\_\_\_\_

\_\_\_\_\_  
Stamp, signature**BMW Service**

Completed

on \_\_\_\_\_

Odometer reading \_\_\_\_\_

Next service  
at the latest

on \_\_\_\_\_

or, if logged beforehand,

Odometer reading \_\_\_\_\_

\_\_\_\_\_  
Stamp, signature

**BMW Service**

Completed

on \_\_\_\_\_

Odometer reading \_\_\_\_\_

Next service  
at the latest

on \_\_\_\_\_

or, if logged beforehand,

Odometer reading \_\_\_\_\_

\_\_\_\_\_  
Stamp, signature**BMW Service**

Completed

on \_\_\_\_\_

Odometer reading \_\_\_\_\_

Next service  
at the latest

on \_\_\_\_\_

or, if logged beforehand,

Odometer reading \_\_\_\_\_

\_\_\_\_\_  
Stamp, signature**BMW Service**

Completed

on \_\_\_\_\_

Odometer reading \_\_\_\_\_

Next service  
at the latest

on \_\_\_\_\_

or, if logged beforehand,

Odometer reading \_\_\_\_\_

\_\_\_\_\_  
Stamp, signature

## Confirmation of service

The table is intended as a record of maintenance and repair work, the installation of optional accessories and, if appropriate, special campaign (recall) work.

Item	Odometer reading	Date







## Appendix

Certificate for electronic immobiliser .....	216
--	-----

## FCC Approval

### Ring aerial in the ignition switch



To verify the authorization of the ignition key, the electronic immobilizer exchanges information with the ignition key via the ring aerial.

This device complies with Part 15 of the FCC rules. Operation is subject to the following two conditions:

- (1) This device may not cause harmful interference, and
- (2) this device must accept any interference received, including interference that may cause undesired operation.



Any changes or modifications not expressly approved by the party responsible for compliance could void the user's authority to operate the equipment. ◀

## Approbation de la FCC

### Antenne annulaire présente dans le commutateur d'allumage



Pour vérifier l'autorisation de la clé de contact, le système d'immobilisation électronique échange des

informations avec la clé de contact via l'antenne annulaire.

Le présent dispositif est conforme à la partie 15 des règles de la FCC. Son utilisation est soumise aux deux conditions suivantes :

- (1) Le dispositif ne doit pas produire d'interférences nuisibles, et
- (2) le dispositif doit pouvoir accepter toutes les interférences extérieures, y compris celles qui pourraient provoquer une activation inopportune.



Toute modification qui n'aurait pas été approuvée expressément par l'organisme responsable de l'homologation peut annuler l'autorisation accordée à l'utilisateur pour utiliser le dispositif. ◀

**A**

Abbreviations and symbols, 6

**ABS**

Control, 15

Engineering details, 114

Operation, 54

Self-diagnosis, 101

Warning light, 30

**Accessories**

General instructions, 168

Socket for optional accessories, 179

**Actuality, 7****Anti-theft alarm**

Activating, 50

adjusting, 51

Deactivating, 50

Operation, 50

Telltale light, 18

Warning light, 33

**ASC**

Control, 15

Engineering details, 117

Operation, 52

Self-diagnosis, 101

Switching off, 52

Switching on, 53

Warning light, 31

**Average values**

Resetting, 49

**B****Battery**

Charging battery when connected, 158

Charging battery when disconnected, 159

connecting to motorcycle, 160

disconnecting from motorcycle, 159

Installation, 161

Maintenance instructions, 157

Position on the vehicle, 14

Removal, 160

Technical data, 198

**Beam throw**

adjusting, 89

**Brake fluid**

Checking fluid level, front, 135

Checking fluid level, rear, 136

Reservoir, front, 13

Reservoir, rear, 13

**Brake pads**

Checking front, 133

Checking rear, 134

Running in, 104

**Brakes**

ABS Pro in detail, 116

ABS Pro depending on riding mode, 107

Adjusting the front brake lever, 90

Checking function, 133

Safety instructions, 105

Technical data, 196

**C****Care**

Body panels, 185

Care products, 184

Chrome, 185

Paint, 185

- Plastics, 185
- Preserving paintwork, 186
- Radiator, 185
- Rubber, 185
- Washing the vehicle, 184
- Windscreen, 185
- Cases
  - Operation, 169
- Chain
  - Adjusting tension, 164
  - Checking tension, 163
  - Checking wear, 164
  - Lubricating, 163
- Checklist, 99
- Clock
  - adjusting, 52
- Clutch
  - Adjusting play, 137
  - Checking function, 136
  - Checking play, 137
  - Technical data, 193
- Coding plug
  - Installation, 58
- Confirmation of maintenance work, 207

- Coolant
  - Checking fill level, 137
  - Fill-level indicator, 13
  - Topping up, 138
  - Warning light for overheating, 27
- Coolant temperature
  - Multifunction display, 21
  - too high, 27
- Cruise-control system
  - Operation, 59

## **D**

- Damping
  - Adjuster, front, 11
  - Adjuster, rear, 13
  - adjusting, with
  - Dynamic ESA, 55
  - adjusting, without
  - Dynamic ESA, 92
- Date
  - adjusting, 34

- Daytime riding lights
  - automatic, 42
  - automatic or manual, 42
  - manual, 44
  - manual with automatic switched on, 43
- Dimensions
  - Technical data, 199
- Drop sensor
  - Telltale light, 30
- DTC
  - Control, 15
  - Engineering details, 117
  - Operation, 53
  - Self-diagnosis, 102
  - Switching off, 53
  - Switching on, 54
  - Warning light, 31
- Dynamic ESA
  - Control, 15
  - Engineering details, 118
  - Operation, 55

**E**

- Electrics
  - Technical data, 198
- Emergency off switch (kill switch)
  - Operation, 40
  - Position on the vehicle, 17

## Engine

- Parking, 39
- starting, 99
- Technical data, 192
- Warning light for engine electronics, 27
- Warning light for engine management system, 28

## Engine oil

- Checking fill level, 131
- Fill-level indicator, 11
- Oil filler neck, 13
- Technical data, 191
- Topping up, 132

## Equipment, 7

**F**

## Frame

- Technical data, 194

## Front-wheel stand

- Installing, 129

## Fuel

- Fuel grade, 109
- Refuelling, 109
- Technical data, 191

## Fuel reserve

- Range, 35
- Warning light, 35

## Fuses

- Position on the vehicle, 14
- Replacing, 162
- Technical data, 198

**G**

## General views

- Instrument panel, 18
- Left multifunction switch, 15
- Left side of vehicle, 11
- Multifunction display, 21
- Right multifunction switch, 17
- Right side of vehicle, 13
- SETUP EQUIPMENT, 68
- SETUP MENU, 64
- SETUP RACETRACK, 82

## Underneath the seat, 14

- Warning and telltale lights, 20

**H**

## Hazard warning flashers

- Control, 15
- Operation, 45

## Headlight

- Adjusting headlight beam throw, 89
- Adjustment for driving on left/driving on right, 89
- Headlight beam throw and spring preload, 89

## Heated handlebar grips

- Control, 17
- Operation, 61

## Horn, 15

**I**

## Ignition

- Switching off, 39
- Switching on, 38

## Immobiliser

- Reserve key, 39
- Warning, 27

Instrument panel  
Gearshift light, 18  
Overview, 18  
Panels for warning and telltale lights, 18  
Photosensor, 18  
Rev. counter, 18

## **J**

Jump-start, 156

## **K**

Keys, 38

## **L**

Laptimer  
Clearing all saved data, 79  
Delete the lap, 79  
Display layout, 82  
Ending timing, 74  
individualising, 73  
Infrared receiver, 73  
Interrupting timing, 74  
Operation, 71  
RACE INFO, 76  
Starting timing, 73

## **Lighting**

Replacing bulb for high-beam headlight, 149  
Replacing bulb for left parking light, 150  
Replacing bulb for low-beam headlight, 149  
Replacing bulb for right side light, 151  
Replacing bulbs for front and rear turn indicators, 153  
Replacing number-plate light, 154  
Replacing rear light, 154  
Technical data, 198  
Warning light for bulb fault, 28, 29

## **Lights**

Control, 15  
Headlight flasher, operating, 41  
High-beam headlight, operating, 41  
Low-beam headlight, operating, 40

Parking lights, operating, 40, 41  
Using daytime riding light, 42  
Lowered suspension  
Restrictions, 96  
Luggage  
Instructions for loading, 96

## **M**

Maintenance  
General instructions, 128  
Maintenance schedule, 205  
Maintenance intervals, 202  
Mirrors  
adjusting, 88  
Mobility services, 202  
Motorcycle  
Care, 183  
Cleaning, 183  
Lashing, 110  
Laying up, 186  
Parking, 108  
Multi-Controller  
Control, 15

Multifunction display, 18

Control, 15

Exiting SETUP mode, 67

Overview, 21

RACE INFO, 76

Select display, 47

Selecting submenu, 65

Setting parameters, 66

SETUP EQUIPMENT, 68

SETUP MENU, 64

SETUP RACETRACK, 82

Multifunction switch

General view, left side, 15

General view, right side, 17

## N

Navigation device

Control, 15

Installation, 174

Removal, 175

## O

Odometer

Resetting, 49

## P

Paint care, 185

Parking, 108

Parking light, 41

Power socket

Notes on use, 168

Pre-Ride-Check, 100

## R

Rear-wheel drive

Technical data, 194

Rear-wheel stand

Installing, 130

Refuelling, 109

Fuel grade, 109

Rev. counter, 18

Rider's Manual

Position on the vehicle, 14

Riding mode

adjusting, 56

Control, 17

deactivatable suspension

and running-gear control

systems, 125

DYNAMIC, 122

DYNAMIC PRO, 123

Engineering details, 119

RAIN, 120

ROAD, 121

Riding specifications

Technical data, 200

Running gear

Technical data, 195

Running in, 103

## S

Safety instructions

for brakes, 105

For riding, 96

Seat

Installation, 62, 63

Lock, 11

Removal, 62

Service, 202

Service-due indicator, 34

SETUP

EQIP:UNITS, 66

EQUIPMENT, 68

MENU, 64

RACETRACK, 82



- Shift assistant
  - Engineering details, 125
  - Riding, 104
- Shifting gear
  - Gearshift light, 104
- Spark plugs
  - Technical data, 198
- Speedometer, 21
- Spring preload
  - Adjuster, front, 11
  - Adjuster, rear, 11
  - adjusting, with
    - Dynamic ESA, 55
    - adjusting, without
      - Dynamic ESA, 90
- Starting, 99
  - Control, 17
- Steering lock
  - Locking, 38

**T**

- Technical data
  - Battery, 198
  - Brakes, 196
  - Clutch, 193
  - Dimensions, 199
  - Electrics, 198
  - Engine, 192
  - Engine oil, 191
  - Frame, 194
  - Fuel, 191
  - Fuses, 198
  - Lighting, 198
  - Rear-wheel drive, 194
  - Riding specifications, 200
  - Running gear, 195
  - Spark plugs, 198
  - Standards, 7
  - Transmission, 193
  - Weights, 200
  - Wheels and tyres, 196
- Telltale lights, 18
  - Overview, 20
- Threaded fasteners, 189
- Toolkit
  - Contents, 128
  - Position on the vehicle, 14
- Topcase
  - Operation, 172
- Torques, 189

- Traction control
  - ASC, 117
  - DTC, 117
- Transmission
  - Technical data, 193
- Trim panels
  - Installing side panel, 155
  - Remove the side panel, 154
- Troubleshooting chart, 188
- Turn indicators
  - Control, 15
  - Operation, 45
- Type plate
  - Position on the vehicle, 13
- Tyres
  - Checking inflation
    - pressure, 138
  - Checking tread depth, 139
  - Pressures, 197
  - Recommendation, 139
  - Running in, 104
  - Table of tyre pressures, 11
  - Technical data, 196
  - Top speed, 97

**V**

Vehicle

Restoring to use, 186

Vehicle Identification Number

Position on the vehicle, 13

VIN

Vehicle Identification

Number, 13

**W**

Warning lights, 18

Overview, 20

Warnings

ABS, 30

Anti-theft alarm, 33

ASC, 31

Bulb faulty, 28

Coolant temperature, 27

Drop sensor, 30

DTC, 31

Electronic immobiliser, 27

Engine control unit, 28

Engine electronics, 27

Fuel reserve, 35

Mode of presentation, 22

Overtemperature, 27

Rear light and bulbs for side  
lights faulty, 29

Warnings, overview, 23

Weights

Payload table, 11

Technical data, 200

Wheels

Change of size, 140

Checking rims, 139

Installing front wheel, 142

Installing the rear wheel, 147

Removing front wheel, 140

Removing rear wheel, 145

Technical data, 196

Windscreen

adjusting, 88



Details described or illustrated in this booklet may differ from the vehicle's actual specification as purchased, the accessories fitted or the national-market specification. No claims will be entertained as a result of such discrepancies.

Dimensions, weights, fuel consumption and performance data are quoted to the customary tolerances.

The right to modify designs, equipment and accessories is reserved.

Errors and omissions excepted.

© 2015 Bayerische Motoren Werke Aktiengesellschaft  
80788 Munich, Germany  
Not to be reproduced by any means whatsoever, wholly or in part, without the written permission of BMW Motorrad, After Sales.

Original rider's manual, printed in Germany.

