



**BMW
MOTORRAD**

RIDER'S MANUAL

R 12 S



MAKE LIFE A RIDE

Vehicle data

Model

Vehicle Identification Number

Colour code

Date of first registration

Registration number

Dealership details

Person to contact in Service department

Ms/Mr

Phone number

Dealership address/phone number (company stamp)

YOUR BMW.

We congratulate you on your choice of a vehicle from BMW Motorrad and welcome you to the community of BMW riders. Familiarise yourself with your new vehicle so that you can ride it safely and confidently in all traffic situations.

About this rider's manual

Read this rider's manual carefully before starting your new BMW. It contains important information on how to operate the controls and how to make the best possible use of all your BMW's technical features.

In addition, it contains information on maintenance and care to help you maintain your vehicle's reliability and safety, as well as its value.

If the time comes to sell your BMW, please remember to hand over this rider's manual to the new owner. It is an important part of the vehicle.

We hope you will enjoy riding your BMW and that all your journeys will be pleasant and safe

BMW Motorrad.

<hr/>		<hr/>	
01 GENERAL INSTRUCTIONS	2	03 STATUS INDICATORS	26
Quick & easy reference	4	Indicator and warning lights	28
Abbreviations and symbols	4	Display, round instrument	29
Equipment	5	Indicator and warning lights, digital display	30
Technical data	5	Digital display, start screen	31
Currency	6	Digital display, PURE RIDE	32
Additional sources of information	6	Warning indicators	33
Certificates and operating licences	6	Service display	55
Data memory	6		
Bluetooth	11		
Intelligent emergency call	12		
<hr/>		<hr/>	
02 GENERAL VIEWS	16	04 INSTRUMENT CLUSTER	58
General view, left side	18	Warnings	60
General view, right side	19	Controls	60
Underneath the seat	20	Operation	62
Multifunction switch, left	21	Setup	67
Multifunction switch, right	22	Display	68
Multifunction switch, right	23	Settings	69
Instrument cluster	24		
Instrument cluster, Digital Display	25	05 OPERATION	72
		Steering lock	74
		Ignition	75
		Emergency-off switch (kill switch)	79
		Intelligent emergency call	80
		Lighting	83
		Anti-theft alarm (DWA)	87

Dynamic Traction Control (DTC)	90
Riding mode	91
Cruise control	93
Hill Start Control Pro (HSC Pro)	96
Tyre pressure monitoring (RDC)	98
Heated grips	98
ConnectedRide Control Seat	102

06 ADJUSTMENT 106

Mirrors	108
Headlight	109
Clutch	109
Brakes	110
Spring preload	111
Damping	114
Gearshift lever	117

07 RIDING 118

Safety information	120
Regular check	123
Starting	123
Running in	125
Shifting gear	125
Brakes	126
Parking your motorcycle	129
Refuelling	130
Securing motorcycle for transportation	132

08 ENGINEERING DETAILS 134

General notes	136
Antilock Brake System (ABS)	136
Dynamic Traction Control (DTC)	139
Dynamic engine brake control (MSR)	141
Battery Guard	142
Riding mode	142
Dynamic Brake Control	144
Tyre pressure control (RDC)	145
Gear Shift Assistant	146
Hill Start Control Pro (HSC Pro)	148
Cornering headlight	149

09 MAINTENANCE 150

General notes	152
Toolkit	153
Preparing screwdriver from on-board toolkit	153
Front-wheel stand	154
Rear-wheel stand	154
Engine oil	154
Brake system	156
Clutch	161
Tyres	162
Wheel rims	163
Wheels	163
Lighting	172
Jump-starting	173

Battery	175	Final drive	206
Fuses	178	Frame	206
Diagnostic connector	180	Chassis and suspension	206
<hr/>		Brakes	208
10 ACCESSORIES	182	Wheels and tyres	208
General notes	184	Electrical system	209
Power sockets	184	Anti-theft alarm	210
USB charging socket	185	Dimensions	210
Luggage	186	Weights	211
Optional accessories	187	Performance figures	211
<hr/>		<hr/>	
11 CARE	190	13 SERVICE	212
Care products	192	Reporting safety-relevant defects	214
Washing the vehicle	192	Recycling	215
Cleaning easily damaged components	193	BMW Motorrad Service	215
Care of paintwork	194	BMW Motorrad service history	216
Paint preservation	195	BMW Motorrad mobility services	217
Laying up motorcycle	195	Maintenance work	217
Restoring motorcycle to use	196	Maintenance schedule	219
<hr/>		BMW Motorrad running-in check	221
12 TECHNICAL DATA	198	Maintenance confirmations	222
Troubleshooting chart	200		
Threaded fasteners	201		
Fuel, R 12 S (0N01)	203		
Fuel, R 12 S A2 (0N11)	203		
Engine oil	204		
Engine R 12 S (0N01)	204		
Engine R 12 S A2 (0N11)	205		
Clutch	205		
Transmission	205		

APPENDIX	234
Declaration of Con-	
formity	235
Battery directive	238
Radio equipment TFT	
instrument cluster	240
Keyless Ride System	
Main Unit	243
Keyless Ride System	
Active Key	246
Radio equipment in-	
telligent emergency	
call	249
Radio equipment	
tyre pressure control	
(RDC)	250

INDEX	252
--------------	------------

GENERAL INSTRUCTIONS

01

QUICK & EASY REFERENCE	4
ABBREVIATIONS AND SYMBOLS	4
EQUIPMENT	5
TECHNICAL DATA	5
CURRENCY	6
ADDITIONAL SOURCES OF INFORMATION	6
CERTIFICATES AND OPERATING LICENCES	6
DATA MEMORY	6
BLUETOOTH	11
INTELLIGENT EMERGENCY CALL	12

4 GENERAL INSTRUCTIONS

QUICK & EASY REFERENCE

An important aspect of this rider's manual is that it can be used for quick and easy reference. Consulting the extensive index at the end of this rider's manual is the fastest way to find information on a particular topic or item. To first read an overview of your vehicle, please go to Chapter 2. All maintenance and servicing work on the vehicle is documented in the "Service" section. The record of the maintenance work you have had performed on your vehicle is a precondition for generous treatment of goodwill claims.

ABBREVIATIONS AND SYMBOLS

 **CAUTION** Low-risk hazard. Non-avoidance can lead to slight or moderate injury.

 **WARNING** Medium-risk hazard. Non-avoidance can lead to fatal or severe injury.

 **DANGER** High-risk hazard. Non-avoidance leads to fatal or severe injury.

 **ATTENTION** Special notes and precautionary measures. Non-compliance can lead to damage to the vehicle or accessory and, consequently, to voiding of the warranty.

 Specific instructions on how to operate, control, adjust or look after items of equipment on the motorcycle.

- Instruction.
- » Result of an activity.
- ▣ Reference to a page with more detailed information.
- ◁ Indicates the end of a passage relating to specific accessories or items of equipment.



Tightening torque.



Technical data.

OE

Optional equipment. The vehicles are assembled complete with all the BMW Motorrad optional equipment originally ordered.

OA	Optional accessories. You can obtain BMW Motorrad optional accessories through your authorised BMW Motorrad dealer; optional accessories have to be retrofitted to the vehicle.
ABS	Anti-lock brake system.
DTC	Dynamic Traction Control.
DWA	Anti-theft alarm.
EWS	Electronic immobiliser.
HSC	Hill Start Control
MSR	Dynamic engine brake control
RDC	Tyre pressure monitoring.

EQUIPMENT

When you ordered your BMW Motorrad, you chose various items of custom equipment. This rider's manual describes optional equipment (OE) and selected optional accessories (OA) provided by BMW. This explains why the manual may also contain descriptions of equipment that

you might not have selected. Please note, too, that on account of country-specific differences, your motorcycle might not be exactly as illustrated.

If your motorcycle contains equipment that has not been described, its description can be found in a separate manual.

TECHNICAL DATA

All dimensions, weights and power ratings stated in the rider's manual are quoted to the standards and comply with the tolerance requirements of the Deutsches Institut für Normung e. V. (DIN).

Technical data and specifications in this rider's manual are guide values. The vehicle-specific data may deviate from these, for example, as a result of selected optional equipment, the national-market version or country-specific measuring procedures. Detailed values can be taken from the vehicle registration documents, or can be obtained from your authorised BMW Motorrad retailer or another qualified service partner or specialist workshop. The specifications in the vehicle documents always have priority

6 GENERAL INSTRUCTIONS

over the information provided in this rider's manual.

CURRENCY

The high safety and quality standards of BMW motorcycles are maintained by constant development work on designs, equipment and accessories.

Because of this, your vehicle may differ from the information supplied in the rider's manual.

At the time of production of the motorcycle, the rider's manual is the most up-to-date source. Owing to updates subsequent to the date of publication, differences between the printed rider's manual and the online version are possible.

Up-to-date information is available at bmw-motorrad.com/service.

ADDITIONAL SOURCES OF INFORMATION

Authorised BMW Motorrad retailer

Your authorised BMW Motorrad retailer will be happy to answer any questions you may have.

Internet

The rider's manual for your vehicle, operating and installation instructions for accessories and general information about BMW Motorrad, in relation to technology, for example, are available for download from bmw-motorrad.com/manuals.

CERTIFICATES AND OPERATING LICENCES

The certificates for the vehicle and the General Operating Permits for accessories can be downloaded from bmw-motorrad.com/certification.

DATA MEMORY

General

Control units are installed in the vehicle. Control units process data that they receive, for example, from vehicle sensors, or that they generate themselves or exchange between each other. Some control units are required for the vehicle to function safely or provide assistance during riding, for example assistance systems. In addition, control units enable comfort or infotainment functions.

Information on data that has been stored or exchanged can be obtained from the manufacturer of the vehicle, for example via a separate booklet.

Personal reference

Each vehicle is identified with a clear vehicle identification number. Depending on the country, the vehicle identification number, the number plate and the corresponding authorities can be referenced to ascertain the registered keeper. There are also other ways to use data obtained from the vehicle to trace the rider or vehicle owner, for example using the Connected-Drive user account.

Data protection rights

In accordance with applicable data protection laws, vehicle users have certain rights in relation to the manufacturer of the vehicle or in relation to companies which collect or process personal data.

Vehicle users have the right to obtain full information at no cost from persons or entities storing personal data of the vehicle user.

These entities may include:

- Manufacturer of the vehicle
- Authorised BMW Motorrad Retailers
- Specialist workshops
- Service providers

Vehicle users have the right to request information on what personal data has been stored, for what purpose the data is used, and where the data comes from. To obtain this information, proof of ownership or use is required.

The right to information also includes information about data that has been shared with other companies or entities. The website of the vehicle manufacturer contains the applicable data protection information. This data protection information includes information on the right to have data deleted or corrected. The manufacturer of the vehicle also provides their contact details and those of the data protection officer on their website.

The registered keeper can also request an authorised BMW Motorrad Retailer or a specialist workshop to read out the data that is stored in the vehicle for a charge.

8 GENERAL INSTRUCTIONS

The vehicle data is read out using the legally prescribed 12 V socket for on-board diagnosis (OBD) in the vehicle.

Legal requirements for the disclosure of data

As part of its legal responsibilities, the manufacturer of the vehicle is obligated to make its stored data available to the relevant authorities. This data is provided in the required scope in individual cases, for example to clarify a criminal offence. In the context of applicable laws, public agencies are entitled in individual cases to read out data from the vehicle themselves.

Operating data in the vehicle

Control units process data to operate the vehicle.

This includes, for example:

- Status reports of the vehicle and its individual components, for example wheel speed, wheel circumferential velocity, deceleration
- Environmental factors, for example, temperature

The data is only processed in the vehicle itself and is generally non-permanent. The data is

not stored beyond the operating period.

Electronic components, for example control units, contain components for storing technical information. Information can be temporarily or permanently stored on the vehicle condition, component loads, incidents or errors.

This information is generally used to document the condition of a component, a module, a system or the surrounding area, for example:

- Operating conditions of system components, for example filling levels, tyre pressure
- Malfunctions and faults in important system components, for example, light and brakes
- Response of the vehicle in special riding situations, for example engagement of the driving dynamics systems
- Information on incidents resulting in damage to the vehicle

The data is necessary for the provision of control unit functions. Furthermore, the data is used to detect and rectify malfunctions and to enable the vehicle manufacturer to optimise vehicle functions.

The vast majority of this data is non-permanent and is only processed in the vehicle itself. Only a small amount of the data is stored in incident or fault memories as required by events.

If services are accessed, for example repairs, service processes, warranty cases and quality assurance measures, this technical information can be read out of the vehicle together with the vehicle identification number.

The information can be read out by an authorised BMW Motorrad Retailer or a specialist workshop. The legally stipulated 12 V socket for on-board diagnosis (OBD) in the vehicle is used to read out the data.

The data is obtained, processed and used by the relevant parts of the retailer network. The data is used to document the technical conditions of the vehicle, to help with error localization, to comply with warranty obligations and to improve quality.

In addition, the manufacturer has various product monitoring obligations arising from

product liability legislation. To meet these obligations, the vehicle manufacturer requires technical data from the vehicle. The data from the vehicle can also be used to check warranty claims from the customer. Fault and event memories in the vehicle can be reset during servicing or repair work by an authorised BMW Motorrad Retailer or a specialist workshop.

Data input and data transfer in the vehicle

General

Depending on the equipment, comfort and customised settings can be stored in the vehicle and can be changed or reset at any time.

If required, data can be entered in the entertainment and communication system of the vehicle, for example using a smartphone.

Depending on the individual equipment, this includes:

- Multimedia data, such as music for playback
- Contacts data for use in connection with a communication system or an integrated navigation system
- Entered destinations
- Data on the use of internet services. This data can be

10 GENERAL INSTRUCTIONS

stored locally in the vehicle or is located on a device that is connected to the vehicle, for example smartphone, USB stick, MP3 player. If this data is stored in the vehicle, the data can be deleted at any time.

This data is transferred to third parties only if personally requested within the context of using online services. This depends on the selected settings when using the services.

Incorporation of mobile devices

Depending on the equipment, mobile devices connected to the vehicle, for example smartphones, can be controlled using the operating elements of the vehicle.

The image and sound of the mobile device can then be output via the multimedia system. At the same time, specific information is transferred to the mobile device. Depending on the type of integration, this includes, for example, position data and additional general vehicle information. This enables optimal use of the selected apps, for example navigation or music playback.

The type of additional data processing is determined by the provider of the respective app. The scope of the possible settings depends on the corresponding app and the operating system of the mobile device.

Services

General

If the vehicle has a wireless connection, this enables the exchange of data between the vehicle and other systems.

The wireless connection is enabled by the vehicle's own transceiver unit or using personally integrated mobile devices, for example smartphones. Online functions can be accessed through this wireless connection. These include online services and apps that are provided by the vehicle manufacturer or by other providers.

Services of the vehicle manufacturer

For online services of the vehicle manufacturer, the individual functions are described at suitable points, for example, rider's manual, manufacturer's website. At the same time, information is also provided on the relevant data protection

law. Personal data may be used to provide online services. Data is exchanged using a secure connection, for example with the IT systems provided by the vehicle manufacturer. Obtaining, processing and using personal data outside of the normal provision of services requires legal permission, contractual agreement or consent. It is also possible to have the entire data connection activated or deactivated. Statutory functions are excluded from this.

Services from other providers

When using online services from other providers, these services are subject to the responsibility and the data protection and operating conditions of the individual provider. The vehicle manufacturer has no influence on the content that is exchanged in this instance. Information on the type, scope and purpose of the data capture and use of personal data as part of the services of third parties can be ascertained from the individual provider.

BLUETOOTH

Bluetooth is a short-range wireless technology. Bluetooth devices are short-range devices transmitting on the license-free ISM band (Industrial, Scientific, Medical) between 2.402...2.480 GHz. They can be operated anywhere in the world without a licence being required.

Although Bluetooth is designed to establish and sustain robust connections over short distances, as with every other wireless technology disruptions are possible. Interference can affect connections or connections can sometimes fail. Particularly when multiple devices operate in a Bluetooth network, with wireless technology of this nature it is not possible to ensure fault-free communications in every situation.

Possible sources of interference:

- interference zones due to transmission masts and similar.
- devices with non-compliant Bluetooth implementations.
- proximity of other Bluetooth-compatible devices.

12 GENERAL INSTRUCTIONS

—shielding by metal objects or bodies.

INTELLIGENT EMERGENCY CALL

—with intelligent emergency call^{OE}

Principle

The intelligent emergency call enables manual or automatic emergency calls, for example, in the event of an accident.

The emergency calls are received by an emergency call centre that is commissioned by the vehicle manufacturer.

For information on operation of the intelligent emergency call and its functions, see the section entitled Operation (▣ 80).

Legal basis

Processing of personal data in conjunction with the intelligent emergency call is in line with the following regulations:

—Protection of personal data:

Directive 95/46/EC of the European Parliament and of the Council.

—Protection of personal data:

Directive 2002/58/EC of the European Parliament and of the Council.

The legal basis for the activation and function of the intelligent emergency call is the concluded ConnectedRide contract for this function, as well as the corresponding laws, ordinances and directives of the European Parliament and of the European Council.

The relevant ordinances and directives regulate the protection of natural persons during the processing of personal data.

The processing of personal data by the intelligent emergency call satisfies the European directives for the protection of personal data.

The intelligent emergency call processes personal data only with the agreement of the registered keeper.

The intelligent emergency call and other services with additional benefits can process personal data only with the express permission of the person affected by the data processing, for example, the registered keeper.

SIM card

The intelligent emergency call operates via mobile communications using the SIM card installed in the vehicle. The SIM card is permanently logged into the mobile phone network to enable rapid connection setup. Data is sent to the vehicle manufacturer in the event of an emergency.

Improving quality

The data that is transferred in an emergency is also used by the manufacturer of the vehicle to improve product and service quality.

Location determination

The position of the vehicle can be determined exclusively by the mobile phone network provider based on the mobile phone site locations. It is not possible for the service provider to link the vehicle identification number and the phone number of the installed SIM card. Only the manufacturer of the vehicle can link a VIN and the phone number of the SIM card installed in a particular vehicle.

Log data of emergency calls

The log data of emergency calls is stored in a memory of the vehicle. The oldest log data is regularly deleted. The log data includes, for example, information on when and where an emergency call was made. In exceptional cases, the log data can be read out of the vehicle memory. As a rule, log data is only read out following a court order, and this is only possible if the corresponding devices are connected directly to the vehicle.

Automatic emergency call

The system is designed so that, following a sufficiently serious accident, which is detected by sensors in the vehicle, an emergency call is automatically activated.

Sent information

When making an emergency call using the intelligent emergency call, the system forwards the same information to the designated emergency call centre as is forwarded to the public emergency call centre by the legal emergency call eCall. In addition, the intelligent emergency call sends the following additional information

14 GENERAL INSTRUCTIONS

to an emergency call centre commissioned by the vehicle manufacturer and, if required, to the emergency services:

- Accident data, for example the direction of impact detected by the vehicle sensors, to assist the emergency services response.
- Contact details, for example the phone number of the installed SIM card and the phone number of the rider, if available, to enable rapid contact with those involved in the accident if required.

Data storage

The data for an activated emergency call is stored in the vehicle. The data contains information on the emergency call, for example the location and time of the emergency call. The voice recordings of the emergency call are stored at the emergency call centre. The voice recordings of the customer are stored for 24 hours in case details of the emergency call need to be analysed. After this, the voice recordings are deleted. The voice recordings of the employee of the emergency call centre are stored for 24 hours for quality assurance purposes.

Information on personal data

The data that is processed as part of the intelligent emergency call is processed exclusively to carry out the emergency call. As part of its statutory obligation, the manufacturer of the vehicle provides information about the data that it has processed and any data that it still has stored.

Regional restriction

A precondition for the operability of the intelligent emergency call function is that the national-market version has to include support for the region where the vehicle is currently in use.

More information about regional restrictions:

support.bmw-motorrad.com

GENERAL VIEWS

02

GENERAL VIEW, LEFT SIDE	18
GENERAL VIEW, RIGHT SIDE	19
UNDERNEATH THE SEAT	20
MULTIFUNCTION SWITCH, LEFT	21
MULTIFUNCTION SWITCH, RIGHT	22
MULTIFUNCTION SWITCH, RIGHT	23
INSTRUMENT CLUSTER	24
INSTRUMENT CLUSTER, DIGITAL DISPLAY	25

18 GENERAL VIEWS

GENERAL VIEW, LEFT SIDE

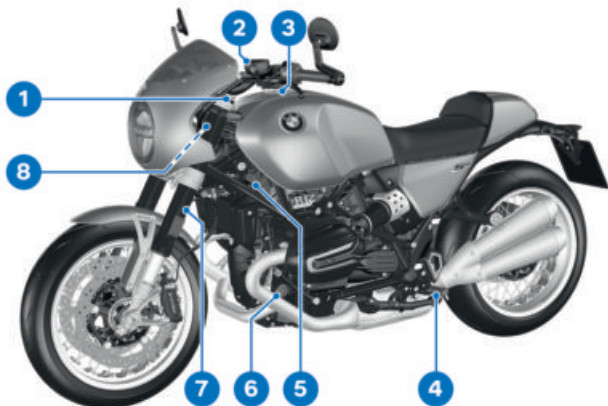

- 1 Damping at front wheel
(☞ 114)
- 2 Clutch-fluid reservoir
(☞ 161)
- 3 Fuel filler neck (☞ 130)
- 4 Rider footrest
- 5 USB charging socket
(☞ 185)
- 6 Engine oil level indicator
(☞ 154)
- 7 Tyre pressures table
(☞ 162)
- 8 Type plate (on steering-head bearing)

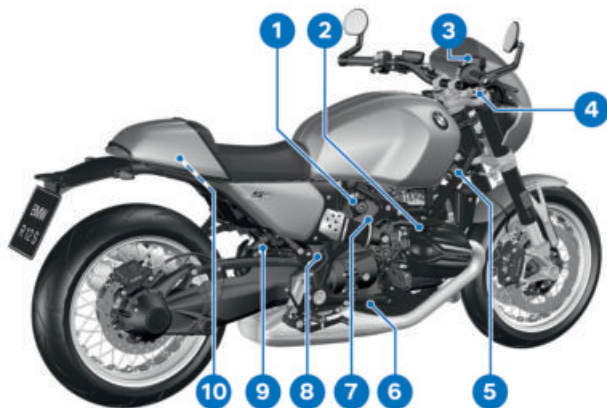
GENERAL VIEW, RIGHT SIDE

- | | |
|---|--|
| 1 Spring preload at rear wheel (➡ 113) | 8 Brake-fluid reservoir, rear (➡ 160) |
| 2 Oil filler opening (➡ 155) | 9 Damping at rear wheel (➡ 116) |
| 3 Brake-fluid reservoir, front (➡ 159) | 10 Removing seat (➡ 102) |
| 4 Spring preload at front wheel (➡ 111) | |
| 5 Power socket (➡ 176) | |
| 6 Vehicle identification number | |
| 7 Diagnostic connector (➡ 180) | |
| On-board toolkit (in cover, diagnostic connector) (➡ 153) | |

20 GENERAL VIEWS

UNDERNEATH THE SEAT

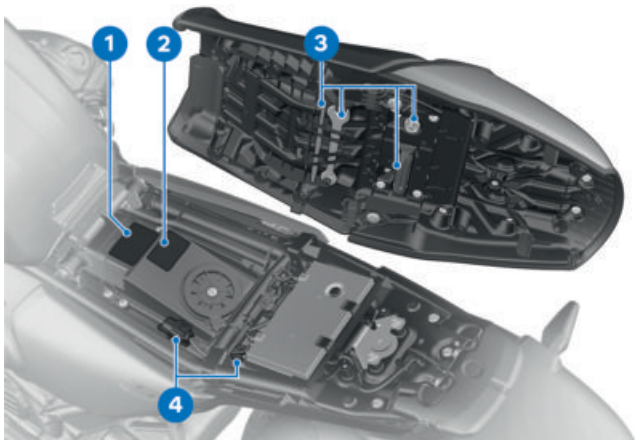

- 1 Payload table
- 2 Toolkit (▣▶ 153)
- 3 Fuses (▣▶ 178)

MULTIFUNCTION SWITCH, LEFT



- 1 High-beam headlight and headlight flasher (►► 83)
- 2 Cruise control (►► 93)
- 3 Hazard warning lights (►► 86)
- 4 Traction control (DTC) (►► 90)
Auxiliary headlights (►► 84)
- 5 Turn indicators (►► 86)
- 6 Horn
- 7 Rocker button (►► 60)
- 8 Multi-Controller (►► 101)
- 9 Grip heating (►► 98)

22 GENERAL VIEWS

MULTIFUNCTION SWITCH, RIGHT



- 1 Ignition (➡ 76)
- 2 Riding mode (➡ 91)
- 3 Emergency-off switch (kill switch) (➡ 79)
- 4 Starter button (➡ 123)

MULTIFUNCTION SWITCH, RIGHT

—with intelligent emergency call^{OE}



- 1 Ignition (➡ 76)
- 2 Riding mode (➡ 91)
- 3 Emergency-off switch (kill switch) (➡ 79)
- 4 Starter button (➡ 123)
- 5 SOS button
Intelligent emergency call
(➡ 80)

24 GENERAL VIEWS

INSTRUMENT CLUSTER

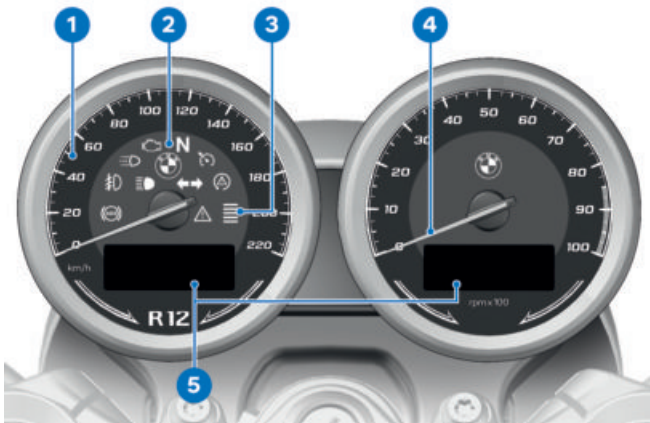

- 1 Speedometer
- 2 Indicator and warning lights (▮▮▮ 28)
- 3 Photosensor for brightness control in the display
DWA light-emitting diode (▮▮▮ 87)
- 4 Rev. counter
- 5 Displays (▮▮▮ 29)

INSTRUMENT CLUSTER, DIGITAL DISPLAY

—with Digital Display^{OE}



- 1 Display
- 2 Photosensor for brightness control in the display
DWA light-emitting diode (☞ 87)
ABS indicator and warning light (☞ 136)

STATUS INDICATORS

03

INDICATOR AND WARNING LIGHTS	28
DISPLAY, ROUND INSTRUMENT	29
INDICATOR AND WARNING LIGHTS, DIGITAL DISPLAY	30
DIGITAL DISPLAY, START SCREEN	31
DIGITAL DISPLAY, PURE RIDE	32
WARNING INDICATORS	33
SERVICE DISPLAY	55

28 STATUS INDICATORS

INDICATOR AND WARNING LIGHTS



- 1** ABS (►►► 136)
- 2** Auxiliary headlights (►►► 84)
- 3** High-beam headlight (►►► 83)
- 4** Daytime riding light (►►► 85)
- 5** Warning light, drive malfunction (►►► 48)
- 6** Neutral indicator light
- 7** Cruise control (►►► 93)
- 8** Turn indicators (►►► 86)
- 9** DTC (►►► 90)
- 10** General warning light
Displayed in combination with warning symbols in the display (►►► 33)

DISPLAY, ROUND INSTRUMENT

- 1 Select the riding mode (►►► 91)
- 2 Gear indicator
- 3 Unit of selected display
- 4 Selecting display in rev. counter (►►► 68)
- 5 Unit of selected display
- 6 On-board computer
Selecting display in speedometer (►►► 62)
Warning symbol (►►► 33)
Status

30 STATUS INDICATORS

INDICATOR AND WARNING LIGHTS, DIGITAL DISPLAY

—with Digital Display^{OE}

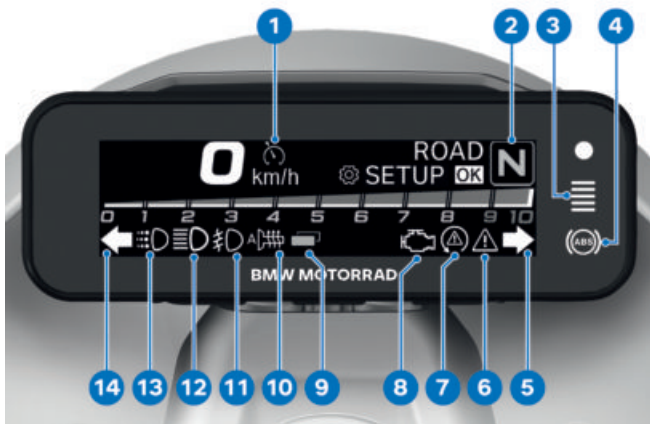

- | | |
|--|--|
| 1 Cruise control (►► 93) | 8 Warning light, drive mal-
function (►► 48) |
| 2 Neutral indicator light
Gear indicator | 9 Bluetooth connection act-
ive (►► 100) |
| 3 Photosensor for bright-
ness control in the display
DWA light-emitting diode
(►► 87) | 10 Grip heating (►► 98) |
| 4 ABS (►► 136) | 11 Auxiliary headlights
(►► 84) |
| 5 Turn indicators, right | 12 High-beam headlight
(►► 83) |
| 6 General warning light
Displayed in combination
with warning symbols in
the display (►► 33) | 13 Daytime riding light
(►► 85) |
| 7 DTC (►► 90) | 14 Turn indicators, left |

DIGITAL DISPLAY, START SCREEN—with Digital Display^{OE}

- 1 Speedometer
- 2 Cruise control (☰ 93)
- 3 Call up PURE RIDE (☰ 32)
Call up the on-board computer (☰ 64)
Call up SETUP (☰ 67)
- 4 Riding mode (☰ 91)
- 5 Gear indicator
- 6 Rev. counter

32 STATUS INDICATORS

DIGITAL DISPLAY, PURE RIDE

—with Digital Display^{OE}



- 1 Speedometer
- 2 Cruise control (→ 93)
- 3 Riding mode (→ 91)
- 4 Gear indicator

WARNING INDICATORS

Mode of presentation

Warnings are indicated by the corresponding warning lights. If two or more warnings occur at the same time, all the appropriate warning lights show. Warning symbols corresponding to the warnings appear in alternate sequence.

The possible warnings are listed on the next pages.



Warnings that do not have a warning light of their own are indicated as follows:

- General warning light **1**
- Fault ID **2**
- Warning symbol **3**

By consulting the overview below, you can use fault ID **2** to ascertain the significance and possible causes of the fault.



Acknowledging warnings

Warnings **2** have to be acknowledged by short-pressing the top or bottom section of rocker button **1**.

The display that was active beforehand does not reappear until warning **2** has been acknowledged.

If two or more warnings are present rocker button **1** has to be pressed to proceed to and acknowledge each warning **2** in turn.

34 STATUS INDICATORS



Calling up active warnings

Repeatedly short-press rocker button **1** until warnings **2** are displayed.

Press rocker button **1** to call up the next warning **2** in the sequence.

The message can be called up again as long as the fault persists.

—with Digital Display^{OE}

Presentation, digital display

Warnings are indicated by the 'General' warning light showing in combination with a dialogue and a fault ID number in the instrument cluster. The 'General' warning light shows yellow or red, depending on the urgency of the warning.

 The status of the 'General' warning light matches the most urgent warning.

The possible warnings are listed on the next pages.

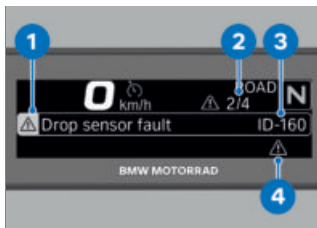

Digital display in "Warnings" view

The messages differ in how they show on the display. Different colours and symbols are used depending on priority:

—Yellow warning triangle **1**:

Warning message.

—Alternatively: White circle with small **i**: Information, or red **STOP**: Critical warning message, do not continue to ride.















—Number of messages **2**.

—Fault ID **3**: For accurate identification of the message.



























—'General' warning light **4**: Red or yellow, depending on the highest urgency.



















Active warnings are also attached dynamically as pop-ups in the on-board computer listing. The message can be called up again as long as the fault persists (➡ 64).

Warnings, overview



























Indicator and warning lights	Display text	Meaning
	 is displayed.	Outside temperature warning (▬▬▬▶ 40)
 flashes regularly.		ABS self-diagnosis not completed (▬▬▬▶ 40)
 slow-flashes.		DTC self-diagnosis not completed (▬▬▬▶ 40)
 quick-flashes.		DTC intervention (▬▬▬▶ 41)
 shows yellow.	 EWS error ID030	Fault, electronic immobiliser (▬▬▬▶ 41)
 shows yellow.	 Traction control fault ID040	DTC failed (▬▬▬▶ 41)
 shows yellow.		
 shows yellow.	 Traction control fault ID041	DTC restricted (▬▬▬▶ 42)
 shows yellow.		
 shows yellow.	 ABS Pro fault ID050	ABS Pro failed (▬▬▬▶ 42)
 shows.		

















36 STATUS INDICATORS

Indicator and warning lights	Display text	Meaning
 shows yellow.  shows.	 ABS fault ID051	ABS failed ( 43)
 shows yellow.  shows.	 ABS fault ID052	ABS fault ( 43)
 shows yellow.	 Remote key fault ID060	Radio-operated key out of range ( 44)
 shows yellow.	 Remote key fault ID061	Keyless Ride failed ( 44)
 shows yellow.	 Remote key bat- tery ID070  Remote key bat- tery ID071	Replacing battery of radio-operated key ( 44)
 shows yellow.	 Alarm system battery fault ID080	Anti-theft alarm battery flat ( 45)
	 Alarm system battery low ID081	Anti-theft alarm battery weak ( 45)
 shows yellow.	 Alarm system fault ID082	DWA failed ( 45)

Indicator and warning lights	Display text	Meaning
	 is displayed in white. Service due soon ID090	Service due (▶▶▶ 45)
 shows yellow.	 is displayed in yellow. Service overdue ID091	Service-due date has passed (▶▶▶ 46)
 shows yellow.	 The faulty bulb is displayed ID101-ID131	Bulb faulty (▶▶▶ 46)
 shows yellow.	 The vehicle light that has failed is indicated ID117/ID126	Light control failed (▶▶▶ 47)
 shows yellow.	 Engine fault ID140	Fault, engine control (▶▶▶ 47)
 flashes red.	 Danger! Engine ID141	Serious fault in engine control (▶▶▶ 47)
 shows.	 Drive fault ID150	Drive malfunction (▶▶▶ 48)
 flashes.	 Drive fault ID152	Serious drive malfunction (▶▶▶ 48)
 shows yellow.	 Drop sensor fault ID160	Drop sensor defective (▶▶▶ 48)
	 Fall sensor triggered ID161	Fall sensor tripped (▶▶▶ 49)

38 STATUS INDICATORS

Indicator and warning lights	Display text	Meaning
 shows yellow.	 Side stand fault ID170	Malfunction, side stand monitor ( 49)
 shows yellow.	 Emergency call syst. fault ID180	Emergency call function failed ( 49)
 shows yellow.	 Emergency call syst. fault ID182	Emergency call function restricted ( 49)
 shows yellow.	 Cruise control fault ID211	Cruise control failed ( 50)
 shows yellow.	 Vehicle voltage fault ID250	Vehicle battery overheated ( 50)
 flashes red.	 Danger! Vehicle voltage ID251	Serious fault in the power supply ( 50)
 shows yellow.	 Vehicle voltage critical. ID260	Voltage of the vehicle electrical system critical ( 51)
 shows yellow.	 Vehicle voltage low ID261	On-board system voltage low ( 51)
 shows red.	 12 V charg. voltage crit. ID270	Battery voltage critical ( 51)

Indicator and warning lights	Display text	Meaning
 shows yellow.	 Fault: Engine too hot ID290	Engine temperature high (►►► 52)
 shows red.	 Danger! Engine too hot ID291	Engine overheated (►►► 52)
 shows yellow.	 Tyre pressure at ID301	Tyre pressure close to limit of permitted tolerance (►►► 52)
 flashes red.	 Danger RDC at ID302, ID303	Tyre pressure outside permitted tolerance (►►► 53)
 shows yellow.	 RDC fault ID304	Tyre pressure monitoring (RDC) failed (►►► 54)
 shows yellow.	 RDC battery fault ID310	Battery for tyre pressure sensor weak (►►► 54)
 shows yellow.	 and distance counter KM R or MI R are displayed.	Fuel down to reserve (►►► 54)
 shows yellow.	 Anti-theft protection ID340	Protection against theft (►►► 55)

40 STATUS INDICATORS

Ambient temperature

The outside temperature is displayed in the on-board computer.

When the vehicle is at a standstill, the heat of the propulsion unit can falsify the ambient-temperature reading. If the heat of the propulsion unit is affecting it too much, dashes are temporarily shown in place of the value.



There is a risk of black ice if the ambient temperature falls below the limit value of approx. 3 °C.

The first time the temperature drops below this value, the ambient-temperature reading and the ice crystal symbol flash in the on-board computer.

Outside temperature warning



is displayed.

Possible cause:



The air temperature measured at the vehicle is lower than:

approx. 3 °C



WARNING

Risk of black ice forming even when temperature is above approx. 3 °C

Risk of accident

- Always take extra care when temperatures are low; remember that there is particular danger of black ice forming on bridges and where the road is in shade.

- Ride carefully and think well ahead.

ABS self-diagnosis not completed



flashes.

Possible cause:

The ABS function is not available, because self-diagnosis did not complete. The motorcycle has to move forward a few metres for the wheel sensors to be tested.

- Pull away slowly. Bear in mind that the ABS function is not available until self-diagnosis has completed.

DTC self-diagnosis not completed



slow-flashes.

Possible cause:



DTC self-diagnosis not completed

The DTC function is not available, because self-diagnosis did not complete. (The motorcycle has to reach a defined minimum speed with the engine running for the wheel sensors to be checked: min. 5 km/h)

- Pull away slowly. Bear in mind that the DTC function is not available until self-diagnosis has completed.

DTC intervention



quick-flashes.

Possible cause:

The DTC has detected a degree of instability at the rear wheel and has intervened to reduce torque.

The indicator and warning light flashes longer than the duration of the DTC. This affords the rider visual feedback on control intervention even after the critical situation has been dealt with.

- You can continue to ride. Ride carefully and think well ahead.

Fault, electronic immobiliser



shows yellow.



EWS error ID030

Possible cause:

The vehicle key being used is not authorised for starting, or communication between vehicle key and electrical machine electronics is disrupted.

- Remove all other vehicle keys from the same ring as the key used for the vehicle.
- Use second vehicle key.
- Have defective vehicle keys replaced, preferably by an authorised BMW Motorrad retailer.

DTC failed



shows yellow.



shows yellow.



Traction control fault ID040

Possible cause:

The engine control unit has detected a DTC fault.

42 STATUS INDICATORS



ATTENTION

Damaged components

Damage to sensors, for example, which causes malfunctions

- Do not transport any objects underneath the driver or passenger seat.
 - Secure the toolkit.
- Do not damage the angular rate sensor.
 - Bear in mind that the DTC function is not available or the functionality might be subject to certain restrictions.
 - You can continue to ride. Bear in mind the more detailed information on situations that can lead to a DTC fault (➡ 140).
 - Have the fault rectified as quickly as possible by a specialist workshop, preferably an authorised BMW Motorrad retailer.

DTC restricted



shows yellow.



shows yellow.



Traction control fault ID041

Possible cause:

The engine control unit has detected a DTC fault.



ATTENTION

Damaged components

Damage to sensors, for example, which causes malfunctions

- Do not transport any objects underneath the driver or passenger seat.
 - Secure the toolkit.
- Do not damage the angular rate sensor.
 - Bear in mind that the DTC function and other dynamic control system functions are restricted.
 - You can continue to ride. Bear in mind the more detailed information on situations that can lead to a DTC fault (➡ 140).
 - Have the fault rectified as quickly as possible by a specialist workshop, preferably an authorised BMW Motorrad retailer.

ABS Pro failed



shows yellow.



shows.



ABS Pro fault ID050

Possible cause:

Monitoring of the ABS Pro function has detected a fault. The ABS Pro function is not available. The ABS function is still available. ABS provides support only for braking in straight-ahead driving.

- You can continue to ride. Bear in mind the more detailed information on certain situations that can lead to an ABS Pro fault message (▶ 138).
- Have the fault rectified as quickly as possible by a specialist workshop, preferably an authorised BMW Motorrad retailer.

ABS failed



shows yellow.



shows.



ABS fault ID051

Possible cause:

The ABS control unit has detected a fault. The ABS function is not available.

- You can continue to ride. Bear in mind the more detailed information on certain situations that can lead to an ABS fault message (▶ 138).
- Have the fault rectified as quickly as possible by a specialist workshop, preferably an authorised BMW Motorrad retailer.

ABS fault



shows yellow.



shows.



ABS fault ID052

Possible cause:

The ABS control unit has detected a fault. The ABS function is available, subject to restrictions.

- You can continue to ride. Bear in mind the more detailed information on certain situations that can lead to an ABS fault message (▶ 138).
- Have the fault rectified as quickly as possible by a spe-

44 STATUS INDICATORS

cialist workshop, preferably an authorised BMW Motorrad retailer.

Radio-operated key out of range



shows yellow.



Remote key fault
ID060

Possible cause:

Communication between radio-operated key and propulsion-unit electronics is disrupted.

- Check the battery in the radio-operated key.
- Replace the battery of the radio-operated key. (► 77)
- Use the spare key to continue your journey.
- Battery of the radio-operated key is empty or loss of the radio-operated key. (► 76)
- Remain calm if the Check Control dialogue appears on the display while you are riding. You can continue your journey, operational readiness will not switch off.
- Have the faulty radio-operated key replaced by an authorised BMW Motorrad retailer.

Keyless Ride failed



shows yellow.



Remote key fault
ID061

Possible cause:

The Keyless Ride control unit has diagnosed a communication fault.

- Do not switch off the motor.
 - Proceed as directly as possible to an authorised workshop, preferably an authorised BMW Motorrad retailer.
- » Motor start with Keyless Ride can no longer be initiated.
- » DWA can no longer be activated.

Replacing battery of radio-operated key



shows yellow.



Remote key battery
ID070



Remote key battery
ID071

Possible cause:

- The integral battery in the radio-operated key has lost a significant proportion of its original capacity. There is no assurance of how long the radio-operated key can remain operational.

- Replace the battery of the radio-operated key. (► 77)

Anti-theft alarm battery flat



shows yellow.



Alarm system battery fault ID080



This error message is displayed briefly only after the Pre-Ride-Check completes.

Possible cause:

The DWA battery is discharged. It is not possible to trigger an alarm after disconnecting the vehicle battery. All other functions of the DWA are functional.

- Consult a specialist workshop, preferably an authorised BMW Motorrad retailer.

Anti-theft alarm battery weak



Alarm system battery low ID081



This error message is displayed briefly only after the Pre-Ride-Check completes.

Possible cause:

The integral battery in the anti-theft alarm has lost a significant proportion of its original capacity. There is no assurance of how long the anti-theft alarm can remain operational if

the vehicle's battery is disconnected.

- Consult a specialist workshop, preferably an authorised BMW Motorrad retailer.

DWA failed



shows yellow.



Alarm system fault ID082

Possible cause:

The DWA control unit has diagnosed a communication fault.

- Consult a specialist workshop, preferably an authorised BMW Motorrad retailer.
- » DWA can no longer be activated or deactivated.
- » False alarm possible.

Service due



is displayed in white.

Service due soon ID090

Possible cause:

Service is due, because of either distance covered or time expired.

- Have your vehicle serviced regularly by a specialist workshop, preferably an authorised BMW Motorrad retailer.
- » The vehicle remains operationally reliable and road-worthy.
- » The vehicle retains its value.

46 STATUS INDICATORS

Service-due date has passed



shows yellow.



is displayed in yellow.

Service overdue ID091

Possible cause:

Service is overdue because of the driving performance or the date.

- Have your vehicle serviced regularly by a specialist workshop, preferably an authorised BMW Motorrad retailer.
- » The vehicle remains operationally reliable and road-worthy.
- » The vehicle retains its value.

Bulb faulty



shows yellow.



The faulty bulb is displayed ID101-ID131:

- with LED additional headlight^{OA}
- Additional headlight fault (left) ID101◁
- with LED additional headlight^{OA}
- Additional headlight fault (right) ID102◁
- Side light fault ID110
- Low-beam headlight fault ID112

- High-beam headlight fault ID113
- Daytime riding light fault ID114
- Front turn indicator fault (left) ID115, Front turn indicator fault (right) ID116
- Rear light fault ID121
- Brake light fault ID122
- Number plate light fault ID123
- Rear turn indicator fault (left) ID124, Rear turn indicator fault (right) ID125
- with Headlight Pro^{OE}
- Active headlight fault ID130, Active headlight fault ID131◁



WARNING

Vehicle overlooked in traffic due to failure of the lights on the vehicle

Safety risk

- Always replace a faulty bulb at the earliest possible opportunity. Consult a specialist workshop, preferably an authorised BMW Motorrad Retailer.

Possible cause:

Bulb faulty

- Visually inspect to ascertain which bulb is defective.
- Have LED light sources replaced as complete units; consult a specialist workshop, preferably an authorised BMW Motorrad retailer.

Light control failed



shows yellow.



The vehicle light that has failed is indicated ID117/ID126:

- Front light fault ID117
- Rear light fault ID126



WARNING

Vehicle overlooked in traffic on account of failure of the vehicle lighting

Safety risk

- Have the fault rectified as quickly as possible by a specialist workshop, preferably an authorised BMW Motorrad retailer.

The vehicle lighting has partially or completely failed.

Possible cause:

Light control has diagnosed a communication fault.

- Have the fault rectified as quickly as possible by a specialist workshop, preferably an authorised BMW Motorrad retailer.

Fault, engine control



shows yellow.



Engine fault ID140

Possible cause:

Communication with the engine control unit has failed.

- You can continue to ride. Have the fault rectified as quickly as possible by a specialist workshop, preferably an authorised BMW Motorrad retailer.

Serious fault in engine control



flashes red.



Danger! Engine ID141

48 STATUS INDICATORS



WARNING

Engine damage when running in emergency-operation mode

Risk of accident

- Ride slowly, avoid accelerating sharply and overtaking.
- If possible, have the vehicle picked up and have the fault rectified by a specialist workshop, preferably an authorised BMW Motorrad retailer.

Possible cause:

The engine control unit has diagnosed a fault that can lead to serious consequential faults.

The engine is in emergency-operation mode.

- It is possible to continue to ride but not recommended.
- Avoid high load and rpm ranges if possible.
- Have the fault rectified as quickly as possible by a specialist workshop, preferably an authorised BMW Motorrad retailer.

Drive malfunction



shows.



Drive fault ID150

Possible cause:

The motor control unit has diagnosed a fault that affects pollutant emissions and/or reduces power.

- Have the fault rectified by a specialist workshop, preferably an authorised BMW Motorrad retailer.
- » You can continue riding; pollutant emissions are higher than the threshold values.

Serious drive malfunction



flashes.



Drive fault ID152

Possible cause:

The engine control unit has diagnosed a fault that can lead to damage to the exhaust system.

- Have the fault rectified as quickly as possible by a specialist workshop, preferably an authorised BMW Motorrad retailer.
- » It is possible to continue to ride but not recommended.

Drop sensor defective



shows yellow.



Drop sensor fault
ID160

Possible cause:

The drop sensor is not available.

- Consult a specialist workshop, preferably an authorised BMW Motorrad retailer.

Fall sensor tripped



Fall sensor
triggered ID161

Possible cause:

The fall sensor has detected a fall and has cut out the motor.

- Hold the vehicle upright and check it for damage.
- Switch the ignition off and then on again or switch the kill switch on and then off again.

Malfunction, side stand monitor



shows yellow.



Side stand fault
ID170

Possible cause:



Side-stand switch or
wiring damaged

The motor will switch off when speed drops below the minimum threshold. You cannot resume your journey.



Side-stand switch or
wiring damaged

min. 5 km/h

- Consult a specialist workshop, preferably an authorised BMW Motorrad retailer.

Emergency call function failed

—with intelligent emergency call^{OE}



shows yellow.



Emergency call syst.
fault ID180

Possible cause:

The control unit of the emergency call system has diagnosed a fault. The emergency call function has failed.

- Bear in mind that an emergency call cannot be made.
- Consult a specialist workshop, preferably an authorised BMW Motorrad retailer.

Emergency call function restricted

—with intelligent emergency call^{OE}



shows yellow.



Emergency call syst.
fault ID182

50 STATUS INDICATORS

Possible cause:

The emergency call cannot be made automatically or cannot be made via BMW.

- Observe the information on operating the intelligent emergency call from page (▶▶▶ 80) onwards.
- Consult a specialist workshop, preferably an authorised BMW Motorrad retailer.

Cruise control failed

—with cruise control^{OE}



shows yellow.



Cruise control fault
ID211

Possible cause:

The control unit has detected a fault.

- Bear in mind that the cruise control function is not available.
- You can continue to ride. Have the fault rectified as quickly as possible by a specialist workshop, preferably an authorised BMW Motorrad retailer.

Vehicle battery overheated



shows yellow.



Vehicle voltage
fault ID250

Possible cause:

The temperature sensor has detected a high temperature in the vehicle battery.

- If possible, ride in the part-load range to cool down the vehicle battery or shut down the motor.
- If the temperature in the vehicle battery is frequently too high, have the fault rectified as soon as possible by a specialist workshop, preferably an authorised BMW Motorrad retailer.

Serious fault in the power supply



flashes red.



Danger! Vehicle
voltage ID251



WARNING

Failure of the vehicle systems

Risk of accident

- Do not continue your journey.

52 STATUS INDICATORS

Possible cause:

Alternator malfunction, battery faulty or fuse has blown.

- Have the fault rectified as quickly as possible by a specialist workshop, preferably an authorised BMW Motorrad retailer.

Engine temperature high



shows yellow.



Fault: Engine too hot ID290



ATTENTION

Riding with overheated engine

Engine damage

- Compliance with the information set out below is essential.

Possible cause:

The temperature sensor has detected a high temperature in the motor.

- If possible, ride in the part-load range to cool down the motor.
- If the motor temperature is frequently too high, have the fault rectified as soon as possible by a specialist workshop, preferably an authorised BMW Motorrad retailer.

Engine overheated



shows red.



Danger! Engine too hot ID291



ATTENTION

Riding with overheated engine

Engine damage

- Compliance with the information set out below is essential.

Possible cause:

Engine is overheated.

- Carefully bring the vehicle to a stop, switch off the engine and wait until the engine has cooled down.
- If engine overheating is a frequent occurrence, have the fault rectified as quickly as possible by a specialist workshop, preferably an authorised BMW Motorrad retailer.

Tyre pressure close to limit of permitted tolerance

—with tyre pressure control (RDC)^{OE}



shows yellow.



Tyre pressure at
ID301

Possible cause:

Measured tyre pressure is close to the limit of permitted tolerance.

- Correct tyre pressure.
- Before adjusting tyre pressure, read the information on temperature compensation and adjusting pressure in the section entitled "Engineering details":

- » Temperature compensation (▮▮▮▮ 146)
- » Pressure adaptation (▮▮▮▮ 146)
- » Find the correct tyre pressures in the following places:
 - Back cover of the rider's manual
 - Tyre pressures table

Tyre pressure outside permitted tolerance

- with tyre pressure control (RDC)^{OE}



flashes red.



Danger RDC at ID302,
ID303



WARNING

Tyre pressure outside the permitted tolerance.

Risk of accident, degradation of the vehicle's driving characteristics.

- Adapt your style of riding accordingly.

Possible cause:

Measured tyre pressure is outside permitted tolerance.

- Check the tyre for damage and to ascertain whether the vehicle can be ridden with the tyre in its present condition. If the vehicle can be ridden with the tyre in its present condition:

- Correct the tyre pressure at the earliest possible opportunity.
- Before adjusting tyre pressure, read the information on temperature compensation and adjusting pressure in the section entitled "Engineering details":
 - » Temperature compensation (▮▮▮▮ 146)
 - » Pressure adaptation (▮▮▮▮ 146)
 - » Find the correct tyre pressures in the following places:
 - Back cover of the rider's manual

54 STATUS INDICATORS

–Tyre pressures table

- Have the tyre checked for damage by a specialist workshop, preferably an authorised BMW Motorrad retailer.

If you are unsure whether the vehicle can be ridden with the tyre in its present condition:

- Do not continue your journey.
- Notify the breakdown service.

Tyre pressure monitoring (RDC) failed

–with tyre pressure control (RDC)^{OE}



shows yellow.



RDC fault ID304

Possible cause:

The tyre pressure control (RDC) control unit has diagnosed a communication fault.

- Consult a specialist workshop, preferably an authorised BMW Motorrad retailer.
- » Tyre pressure warnings not available.

Battery for tyre pressure sensor weak

–with tyre pressure control (RDC)^{OE}



shows yellow.



RDC battery fault ID310



This error message is displayed briefly only after the Pre-Ride-Check completes.

Possible cause:

The integral battery in the tyre-pressure sensor has lost a significant proportion of its original capacity. There is no assurance of how long the tyre pressure monitoring system can remain operational.

- Consult a specialist workshop, preferably an authorised BMW Motorrad retailer.

Fuel down to reserve



shows yellow.



and distance counter KM R or MI R are displayed.



WARNING

Irregular engine operation or engine shutdown due to lack of fuel

Risk of accident, damage to catalytic converter

- Do not run the fuel tank dry.

56 STATUS INDICATORS



 The date saved in the instrument cluster must be adjusted if the service display appears more than one month prior to the service-due date. This situation may occur if the battery has been disconnected from the vehicle.

When a service is due within 1000 km, symbol for service due **1** and countdown distance **2** are displayed and the countdown proceeds in steps of 100 miles/kilometres. You can also call up the service data by navigating to **SETUP**, **SERVICE**.

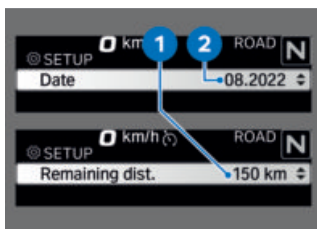

—with Digital Display^{OE}

When a service is due within one month or within 1000 km, service-due date **2** or countdown distance **1** is displayed. You can also call up the service data by navigating to **SETUP**, **SERVICE**.<

INSTRUMENT CLUSTER

04

WARNINGS	60
CONTROLS	60
OPERATION	62
SETUP	67
DISPLAY	68
SETTINGS	69

60 INSTRUMENT CLUSTER

WARNINGS



WARNING

Operation of a smartphone while riding the vehicle

Risk of accident

- Always comply with the road traffic regulations in force where you are riding.
- Do not use a smartphone while riding. This applies with the exception of applications without operation, such as hands-free telephony.



WARNING

Distraction from the road and loss of control

Operating the integrated information system and communication devices while driving results in a risk of accident

- Operate those systems or devices only when the traffic situation allows for it.
- If necessary, stop and operate the systems or devices when stationary.

CONTROLS

Rocker button



Short-press the top section of rocker button 1:

- Go back to previous entry
- Configure settings

Long-press the top section of rocker button 1:

- Go back to previous hierarchy level

- with Digital Display^{OE}

- Exit PURE RIDE view

Short-press the bottom section of rocker button 1:

- Show next entry
- Configure settings

Long-press the bottom section of rocker button 1:

- Confirm selection
- In the on-board computer:
Reset value

- with Digital Display^{OE}
- In Start screen: Call up the
PURE RIDE view

62 INSTRUMENT CLUSTER

OPERATION

SELECTING DISPLAY IN SPEEDOMETER



- Switch on the ignition.
(→ 76)
» The on-board computer readings appear on the display.
- Repeatedly short-press rocker button **1** until the desired value is displayed.

Possible displays:



Odometer



Tripmeter 1



Automatic tripmeter, is reset automatically 6 hours after the ignition is switched off and the date has changed.



Average consumption



Average speed



Electrical machine temperature



On-board voltage

—with tyre pressure control (RDC)^{OE}



Tyre pressure◀



Engine speed



Ambient temperature



Time



Countdown distance to next service due, selectable only when next service due within 1000 km or service is overdue.



Service-due date, selectable only when next service is due within one month or service is overdue.

» The on-board computer content displayed can be configured to suit your preferences.

- Configure the on-board computer displays. (▣▣▣▣▶ 68)

66 INSTRUMENT CLUSTER

Reset the on-board computer

- Switch on the ignition.
( 76)



- Repeatedly short-press rocker button **1** until the value you want to reset is displayed.
 - Long-press the bottom section of rocker button **1** until the value you selected is reset.
- » The following values can be reset:
- Trip distance recorder reading
 - Average consumption
 - Average speed

SETUP

Select SETUP Requirement

The vehicle is at a standstill.



- Repeatedly short-press rocker button **1** until **SETUP** is displayed.
- Long-press the bottom section of rocker button **1** to call up **SETUP**.
- Repeatedly short-press rocker button **1** to select the following menus:
 - VEHICLE
 - SYSTEM
 - DISPLAY
 - SERVICE
 - RESET
 - BACK
- Long-press the bottom section of rocker button **1** to open the desired menu.

Exit SETUP



- Long-press the top section of rocker button **1**.
 - » **SETUP** is displayed.
 - » Settings were saved.
- Alternatively: Repeatedly short-press rocker button **1** until **BACK** is displayed.
- Long-press the bottom section of the **1** rocker button.
 - » **SETUP** is displayed.
 - » Settings were saved.
- Alternatively: Switch ignition off and on again.
 - » **SETUP** exited and settings not saved.
- Alternatively: Ride off.



Speed for operation in
SETUP mode

max. 10 km/h

- » When permissible maximum speed for operation is exceeded, **SETUP** is exited and the settings are not saved.

68 INSTRUMENT CLUSTER

Resetting SETUP

- Switch on the ignition.
- Select SETUP. (▣▣▣ 67)



- Repeatedly short-press rocker button **1** until RESET is displayed.
- Long-press the bottom section of rocker button **1** to reset SETUP.

 Date and time can also be reset to a default value by using the SETUP RESET function.

- Exit SETUP. (▣▣▣ 67)

DISPLAY

Selecting display in rev. counter

—without Digital Display^{OE}

- Switch on the ignition. (▣▣▣ 76)
 - » The riding mode and the gear indicator are displayed in the rev. counter.
- Navigate to SETUP, DISPLAY and select RPM INFO.

- Select display.

Possible displays:

- EMPTY: Only riding mode and gear indicator are displayed
- TOTAL: Odometer
- TRIP 1: Tripmeter 1
- TRIP A: Automatic tripmeter, is reset automatically 6 hours after the ignition is switched off and the date has changed.
- AV CONS: Average consumption
- ∅ SPEED: Average speed
- ENGINE: Electrical machine temperature
- BATTERY: On-board voltage
- with tyre pressure control (RDC)^{OE}
- RDC: Tyre pressure<
- TEMP.: Ambient temperature
- CLOCK: Time

» The selected reading is displayed along with the riding mode and the gear indicator in the rev. counter.

Configuring on-board computer displays Requirement

The vehicle is at a standstill.

- Switch on the ignition. (▣▣▣ 76)
 - without Digital Display^{OE}
- Navigate to SETUP, DISPLAY and select OBC.

The following displays can be deactivated:

- TRIP 1: Tripmeter 1
- TRIP A: Automatic tripmeter, is reset automatically 6 hours after the ignition is switched off and the date has changed.
- AV CONS: Average consumption
- Ø SPEED: Average speed
- ENGINE: Electrical machine temperature
- BATTERY: On-board voltage
- with tyre pressure control (RDC)^{OE}
- RDC: Tyre pressure◀
- RPM: Engine speed
- TEMP.: Ambient temperature
- CLOCK: Time◀
- with Digital Display^{OE}
 - Navigate to SETUP, DISPLAY and select ON-BOARD COMP.. The following displays can be deactivated:
 - Trip 1: Tripmeter 1
 - Trip A: Automatic tripmeter, is reset automatically 6 hours after the ignition is switched off and the date has changed.
 - Consumption: Average consumption
 - Speed: Average speed
 - Coolant temperature
 - Vehicle voltage
 - with tyre pressure control (RDC)^{OE}
 - Tyre pressure: Tyre pressure◀
 - Outside temperature

-Time◀

Adjusting display brightness

- Switch on the ignition. (▣▣▣ 76)
- Navigate to SETUP, DISPLAY and select BRIGHTNESS.
- Adjust the display brightness.

SETTINGS

Changing system settings

- Switch on the ignition. (▣▣▣ 76)
- Navigate to SETUP, SYSTEM.
- Select the system setting,
 - without Digital Display^{OE}
 - » You can change the following system settings:
 - DATE+TIME: Set the date and time.
 - LANGUAGE: Set the language.
 - UNITS: Set the units.◀
 - without Digital Display^{OE}
 - with ConnectedRide Control^{OE}
 - » additionally:
 - CONNECT.: Switch Bluetooth on or off.◀
 - with Digital Display^{OE}
 - » You can change the following system settings:
 - DATE & TIME: Set the date and time.
 - LANGUAGE: Set the language.
 - UNITS: Set the units.◀

70 INSTRUMENT CLUSTER

- with Digital Display^{OE}
- with ConnectedRide Control^{OE}
- » additionally:
 - Connections: Switch Bluetooth on or off.◀

OPERATION

05

STEERING LOCK	74
IGNITION	75
EMERGENCY-OFF SWITCH (KILL SWITCH)	79
INTELLIGENT EMERGENCY CALL	80
LIGHTING	83
ANTI-THEFT ALARM (DWA)	87
DYNAMIC TRACTION CONTROL (DTC)	90
RIDING MODE	91
CRUISE CONTROL	93
HILL START CONTROL PRO (HSC PRO)	96
TYRE PRESSURE MONITORING (RDC)	98
HEATED GRIPS	98
CONNECTEDRIDE CONTROL	99
SEAT	102

74 OPERATION

STEERING LOCK

Locking the steering lock

WARNING

Restricted steering angle when steering lock engaged

Risk of falling

- Unlock the steering lock before attempting to pull away.
- Before pulling away, remove the key from the steering lock.



- Turn the handlebars all the way to the left and insert the vehicle key into steering lock **1**.

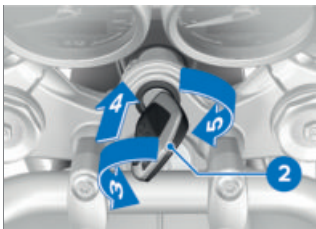

- Turn vehicle key **2** counter-clockwise **3** in the steering lock.
 - Use vehicle key **2** to push the steering lock in **4** and hold it in this position.
 - Turn vehicle key **2** clockwise **5**.
- » Steering lock is engaged.
- Remove vehicle key **2**.

Unlocking steering lock

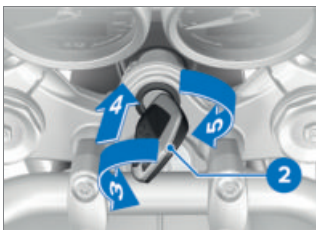

- Push vehicle key **2** into the steering lock **4** and turn it counter-clockwise **3**.
- » The steering lock is disengaged.
- Turn vehicle key **2** clockwise **5**.

- Remove vehicle key **2**.

IGNITION

Radio-operated key

The motorcycle is supplied with one radio-operated key and one spare key. If a key is lost or mislaid, consult the information on the electronic immobiliser (EWS) (☛ 78).

Ignition and anti-theft alarm system, if fitted, work with the radio-operated key. Steering lock and fuel filler cap are locked and unlocked manually.

 The vehicle cannot be started while the radio-operated key is out of range. If the radio-operated key remains out of range the ignition is switched off after about 90 seconds to protect the battery.



Range of the Keyless Ride radio-operated key

approx. 1 m

After the ignition is switched on (☛ 76) connection status is indicated by an indicator light in the instrument cluster.



—with Digital Display^{OE}



- Indicator light **1** flashes: Locating radio-operated key.
- Indicator light **1** shows: Radio-operated key or spare key not found.
- Indicator light **1** slow-flashes: Radio-operated key not cleared. Move the radio-operated key and switch the ignition on again (☛ 76).
- Indicator light **1** goes out: Radio-operated key or spare key found and cleared.

76 OPERATION

Switching on ignition Requirement

Radio-operated key is cleared.



- Press button 1.

Side lights and all function circuits are switched on.

- Engine can be started.

Switching off ignition Requirement

Radio-operated key is cleared.



- Press button 1.

» Lights and all function circuits are switched off.

Battery of the radio-operated key is empty or loss of the radio-operated key

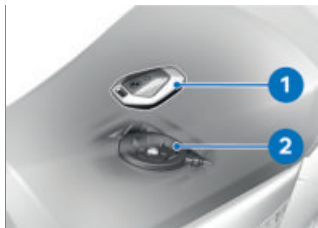

- Consult the information on the electronic immobiliser (EWS) if a key is lost or mislaid.
- If the radio-operated key is lost or mislaid while you are on a journey, you can start the vehicle with the spare key.
- If the battery of the radio-operated key is empty, the vehicle can be started by simply inserting the folded radio-operated key into the ring aerial under the seat.
- Remove the seat. (▶ 102)
- Insert the spare key or folded-in radio-operated key with the empty battery 1 into ring aerial 2.

 The spare key or the closed radio-operated key with the empty battery **must be inserted into** the opening in the ring aerial.



Time during which the motor has to be started. The unlocking procedure has to be repeated if this time is allowed to expire.

30 s

- » Pre-Ride-Check is performed.
- Key has been recognised.
- Engine can be started.
- Start the engine. (►► 123)
- Install the seat. (►► 103)

Checking battery voltage of radio-operated key



The battery voltage of the radio-operated key is indicated by the colour of LED **2**.

- Press button **1**.
- » LED shows green: Battery voltage normal
- » LED shows orange: Battery voltage low
- » LED shows red: Battery voltage critical

The battery of the radio-operated key has to be replaced when the LED shows red.

- Replace the battery of the radio-operated key. (►► 77)

Replacing battery of radio-operated key

If the radio-operated key does not react when you short-press or long-press a button:

- Battery of the radio-operated key is not at full capacity.



is displayed.



DANGER

Swallowing a battery

Risk of injury or death

- An ignition key contains a button cell as its battery. Batteries or button cells, if swallowed, can cause serious or fatal injury within two hours, for example resulting from internal burns or caustic action.
- Keep ignition keys and batteries out of reach of children.
- If there is any suspicion that a battery or button cell has been swallowed or is inside a part of the body, seek medical assistance immediately.

78 OPERATION

- Change the battery.



- Press button **1**.
 - » Key bit flips out.
- Push battery cover **2** up.
- Remove battery **3**.
- Dispose of the old battery in accordance with all applicable laws and regulations; do not attempt to dispose of batteries as domestic waste.



ATTENTION

Unsuitable or incorrectly inserted batteries

Component damage

- Use a battery compliant with the manufacturer's specifications.
 - When inserting the battery, always make sure polarity is correct.
- Insert the new battery with the positive terminal up.



Battery type

For Keyless Ride radio-operated key

CR 2032

- Install battery cover **2**.
 - » Indicator light in the instrument cluster flashes.
 - » The radio-operated key is again ready for use.

Electronic immobiliser (EWS)

The on-board electronics access the data saved in the ignition key via a ring aerial in the ignition lock. The engine control unit will not permit the engine to be started unless the key is identified as "authorised".



A second ignition key attached to the same ring as the ignition key used to start the engine could "irritate" the electronics, in which case the enabling signal for starting is not issued. The warning with the key symbol appears in the display.

Always keep other vehicle keys separate from the vehicle key used to start the engine.

If you lose a key, you can have it barred by your authorised BMW Motorrad retailer.

If you wish to do this, you will need to bring all other keys for the motorcycle with you. The electrical machine cannot be started by a barred key, but a key that has been barred can subsequently be reactivated. You can obtain extra keys only through an authorised BMW Motorrad retailer. The keys are part of an integrated security system, so the retailer is under an obligation to check the legitimacy of all applications for replacement/extra keys.

EMERGENCY-OFF SWITCH (KILL SWITCH)



- 1** Emergency-off switch (kill switch)

WARNING

Operation of the kill switch while riding

Risk of fall due to rear wheel locking

- Do not operate the kill switch when riding.

The emergency off switch is a kill switch for switching off the engine quickly and easily.



- A** Engine switched off
B Normal operating position (run)

 You cannot start the engine unless the kill switch is in the run position.

80 OPERATION

INTELLIGENT EMERGENCY CALL

—with intelligent emergency call^{OE}

Emergency call via BMW

Press the SOS button in an emergency only.

The emergency call is not able to be ensured because of technical reasons due to unfavourable conditions, e.g. in areas where there is no mobile phone reception.

During an emergency call, the location of the vehicle, the choice of language and, if applicable, accident-related data are transmitted to BMW (▣▣▣▣ 12). Under unfavourable conditions, data transfer can be restricted or delayed. This can lead to delayed processing of the emergency call.

Even if an emergency call using BMW is not possible, the system may make an emergency call to a public emergency call number. This depends on the respective mobile phone network and the national regulations.

Language for emergency call

Each vehicle has an assigned language; this language depends on the market to which the vehicle was originally destined. The BMW Call Center answers in this language.

 The language for the emergency call can be changed only by the authorised BMW Motorrad retailer.

The language assigned to the vehicle varies from the selectable language the rider can choose as the display language in the instrument cluster.

Manual emergency call Requirement

An emergency has occurred.
The vehicle is at a standstill.
The ignition is switched on.



- Open cover **1**.
- Short-press SOS button **2**.

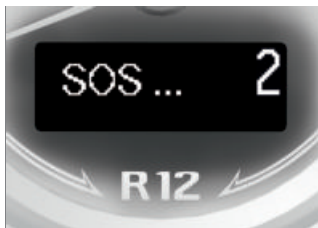

—with Digital Display^{OE}

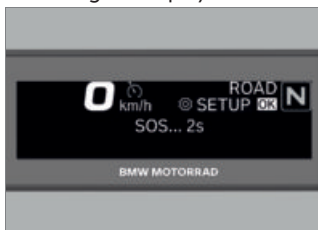

» The time until transmission of the emergency call is displayed. During that time, it is possible to cancel the emergency call.

- To cancel an emergency call: Press SOS button **2** and hold it down for two seconds or switch the ignition off.
- Operate the emergency-off switch to stop the engine.
- Remove helmet.

» After expiry of the timer, a voice contact to the BMW Call Center is established.



The connection was established.

—with Digital Display^{OE}

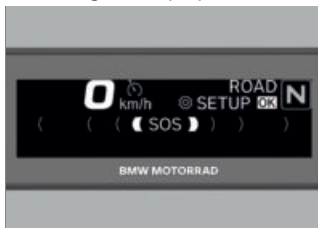

The connection was established.◀



- Provide information to the emergency services using the microphone **3** and speaker **4**.

82 OPERATION

Automatic emergency call

The intelligent emergency call is active after the ignition is switched on and reacts if a fall or crash occurs.

Emergency call in the event of a light fall

- A light fall or a crash was detected.
- » An acoustic signal is sounded.



—with Digital Display^{OE}

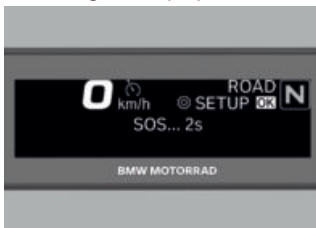

- » The time until transmission of the emergency call is displayed. During that time, it is possible to cancel the emergency call.

- To cancel an emergency call:
 - Press the SOS button and hold it down for two seconds or switch the ignition off.
 - If possible, remove helmet and stop engine.
- » A voice contact connection to the BMW Call Center is established.



The connection was established.

—with Digital Display^{OE}



The connection was established.◁

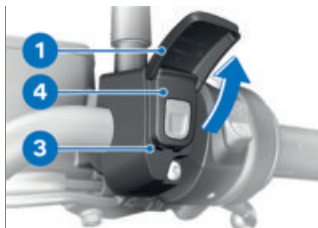

- Open cover **1**.
- Provide information to the emergency services using the microphone **3** and speaker **4**.

Emergency call in the event of a severe fall

- A severe fall or a crash is detected.
- » The emergency call is placed automatically without delay.

LIGHTING

Side light

The side lights switch on automatically when the ignition is switched on.



The side lights place a strain on the battery. Switch on the ignition for a limited time only.

Low-beam headlight

- Switch on the ignition. (▶▶▶ 76)
- Start the engine. (▶▶▶ 123)

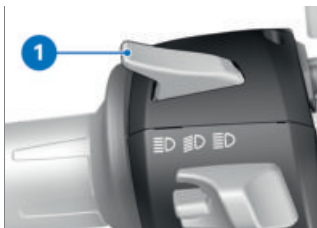

- Alternatively: With the ignition switched on, pull switch **1**.

High-beam headlight and headlight flasher

- Switch on the ignition. (▶▶▶ 76)

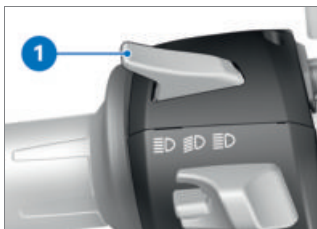

- Push switch **1** forward to switch on the high-beam headlight.
- Pull switch **1** back to operate the headlight flasher.

Headlight courtesy delay feature

- Switch off the ignition. (▶▶▶ 76)

84 OPERATION

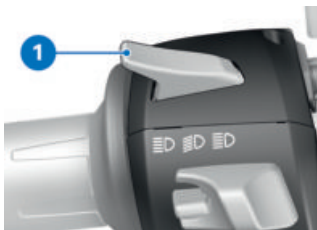

- Immediately after switching off the ignition, pull switch **1** back and hold it in that position until the headlight courtesy delay feature comes on.
 - » The vehicle's lights come on for one minute and then switch off automatically.
 - This can be used to light up the path to the house door after the vehicle has been parked, for example.

Parking lights

- Switch off the ignition.
(76)



- Immediately after switching off the ignition, push button **1** to the left and hold it

in that position until the parking lights come on.

- Switch the ignition on and off again to switch off the parking lights.

Auxiliary headlights

– with LED additional headlight^{OA}

Requirement

The auxiliary headlights are active only when the low-beam headlight is active.

The auxiliary headlights can be switched on only when the daytime riding lights are switched off.

The auxiliary headlights are approved as fog lights and can be used only in poor weather conditions. Always comply with the road traffic regulations in force in the country in which the vehicle is used.

- Start the engine. (123)



- Press button **1** to switch on the additional headlight.

 The indicator light for the additional headlight illuminates.

- Press button **1** again to switch off the additional headlight.

Automatic daytime riding light

 The changeover between daytime riding light and low-beam headlight including front side lights can be effected automatically.



WARNING

The automatic daytime riding light is not a substitute for the rider's personal judgement of the light conditions

Risk of accident

- Switch off the automatic daytime riding light in poor light conditions.

- Switch on the ignition.

( 76)

—without Digital Display^{OE}

- Navigate to **SETUP, VEHICLE, LIGHTS** and switch on the **AUTO** function.

» If ambient brightness drops below a certain value, the low-beam headlight is automatically switched on (e.g. in a tunnel). When sufficient ambient brightness is detected, the daytime riding light is switched back on.

 The indicator light for the daytime riding light shows if the daytime riding light is active.◀

—with Digital Display^{OE}

- Navigate to **SETUP, VEHICLE, LIGHTS** and switch on the **Auto** function.

» If ambient brightness drops below a certain value, the low-beam headlight is automatically switched on (e.g. in a tunnel). When sufficient ambient brightness is detected, the daytime riding light is switched back on.

 The indicator light for the daytime riding light shows if the daytime riding light is active.◀

86 OPERATION

Hazard warning lights

 The hazard warning flashers place a strain on the battery. Do not use the hazard warning flashers for longer than absolutely necessary.

 If you press a turn-indicator button while the hazard warning lights are switched on, the turn-indicator function is activated instead of the hazard warning flashers and remains active until you release the button. The hazard warning flashers recommence flashing as soon as the button is released.

- Switch on the ignition.
( 76)



- Press button **1** to switch on the hazard warning lights system.
» Ignition can be switched off.
- To switch off the hazard warning flashers, switch

on the ignition and press button **1** again.

Turn indicators

- Switch on the ignition.
( 76)
—without Digital Display^{OE}
- Navigate to **SETUP, VEHICLE, LIGHTS.**
- Switch **TURN IND.** on or off.
◀
- with Digital Display^{OE}
- Navigate to **SETUP, VEHICLE, LIGHTS.**
- Switch **Comfort turn indicator on or off.**◀



- Push button **1** to the left or right, as appropriate, to switch on the turn indicators.
» If the comfort turn indicators function is switched on, the turn indicators are cancelled automatically when the speed-dependent distance is covered.
- Alternatively: Press button **1** to cancel the turn indicators.

ANTI-THEFT ALARM (DWA)

—with anti-theft alarm (DWA)^{OE}

Automatic activation

- Switch on the ignition.
(▣▣▣▶ 76)
- Adapt DWA. (▣▣▣▶ 89)
- Switch off the ignition.
(▣▣▣▶ 76)

—without Digital Display^{OE}

» If **AUTO** the DWA anti-theft alarm is activated, the DWA will be automatically armed after the ignition is switched off.◁

—with Digital Display^{OE}

- » If **Auto** the DWA anti-theft alarm is activated, the DWA will be automatically armed after the ignition is switched off.◁
- » Activation takes approximately 30 seconds to complete.
- Turn indicators flash twice.
- » Confirmation tone sounds twice (if programmed).
- » Anti-theft alarm (DWA) is active.

Activation with radio-operated key



- Switch off the ignition.
(▣▣▣▶ 76)
- Press button **1** on the radio-operated key once.
 - » Activation takes approximately 30 seconds to complete.
 - » Turn indicators flash twice.
 - » Confirmation tone sounds twice (if activated).
 - » Anti-theft alarm is active.

Activating transport mode

- If the motorcycle is transported by train or trailer, strong movements can trigger an alarm. To activate the transport mode, press key **1** of the radio-operated key once again during the activation phase.
- without Digital Display^{OE}
- Alternatively, the transport mode can be activated in the menu **SETUP, VEHICLE, ALARM SYS, TRANSPORT.**
(▣▣▣▶ 89)

Light signals issued by the indicator light:

- Flashes 1x: Motion sensor 1
- Flashes 2x: Motion sensor 2
- Flashes 3x: Operational readiness switched on with unauthorised key
- Flashes 4x: Disconnection of the DWA anti-theft alarm from the motorcycle's battery
- Flashes 5x: Motion sensor 3

Deactivation

- Switch on the ignition.
(▮▮▮ 76)



- Alternatively, press key **1** of the radio-operated key once.
 - » Turn indicators flash once.
 - » Confirmation tone sounds once (if activated).
 - » DWA is switched off.
- without Digital Display^{OE}
 - » If the alarm function is deactivated by the radio-operated key and operational readiness is not subsequently switched on, the alarm function is automatically reactivated after ap-

prox. 30 seconds if AUTO is switched on.◁

- with Digital Display^{OE}
 - » If the alarm function is deactivated by the radio-operated key and operational readiness is not subsequently switched on, the alarm function is automatically reactivated after approx. 30 seconds if Auto is switched on.◁

Adapt DWA

- Navigate to **SETUP, VEHICLE, Anti-theft alarm (DWA)**.
 - without Digital Display^{OE}
 - » The following settings are available:
 - Switch **TRANSPORT** on or off
 - Switch **SIGNAL** on or off
 - Switch **AUTO** on or off
 - Adapting **ALARM**◁
 - with Digital Display^{OE}
 - » The following settings are available:
 - Switch **Transport mode** on or off
 - Switch **Signal** on or off
 - Switch **Auto** on or off
 - Adapting **Alarm tone**◁
 - » Possibilities for adjustment (▮▮▮ 90)

90 OPERATION

Possibilities for adjustment

—without Digital Display^{OE}

ALARM: Set the rising and falling or intermittent alarm tone.

TRANSPORT: Activate transport mode. The inclination of the vehicle is no longer monitored in transport mode.

 When the vehicle is going to be transported, deactivate the tilt sensor to prevent the anti-theft alarm (DWA) from being triggered.

SIGNAL: In addition to turn indicators flashing, alarm tone sounds as confirmation of activation/deactivation of the DWA.

AUTO: Automatic activation of the alarm function after the ignition is switched off.

—with Digital Display^{OE}

Alarm tone: Set the rising and falling or intermittent alarm tone.

Transport mode: Activate transport mode. The inclination of the vehicle is no longer monitored in transport mode.

 When the vehicle is going to be transported, deactivate the tilt sensor to prevent the anti-theft alarm (DWA) from being triggered.

Signal: In addition to turn indicators flashing, alarm tone sounds as confirmation of activation/deactivation of the DWA.

Auto: Automatic activation of the alarm function after the ignition is switched off.

DYNAMIC TRACTION CONTROL (DTC)

Switching off DTC function

- Switch on the ignition.

( 76)

 You have the option of deactivating Dynamic Traction Control (DTC) while the motorcycle is on the move.



- Press and hold down button **1** until the DTC indicator and warning light changes its status.



starts to show.

» The DTC function is switched off.

Switching on DTC function



- Press and hold down button **1** until the DTC indicator and warning light changes its status.

 goes out; if self-diagnosis has not completed it starts flashing.

- » The DTC function is switched on.
- You also have the option of switching the ignition off and then on again.

 A DTC fault has occurred if the DTC warning light shows when the motorcycle accelerates to a speed in excess of the minimum stated below after the ignition was switched off and then on again.

min. 5 km/h

- For more information on DTC traction control, see the section entitled "Engineering details" (▮▮▮ 139).

RIDING MODE

Using riding modes

BMW Motorrad has developed operational scenarios for your motorcycle from which you can select the scenario suitable for your situation:

- RAIN: Riding on rain-wet roads.
- ROAD: Riding on dry roads.
- DYNAMIC: Dynamic riding on dry roads.

The optimum interplay of engine characteristic, ABS control and DTC control is provided for each of these scenarios.

For more information on the riding modes, see the section entitled "Engineering details" (▮▮▮ 142).

Select the riding mode

- Switch on the ignition. (▮▮▮ 76)



- Press button **1**.

92 OPERATION

—without Digital Display^{OE}



The active riding mode **1** is displayed. The guide **2** indicates how many riding modes are available.◁

—with Digital Display^{OE}

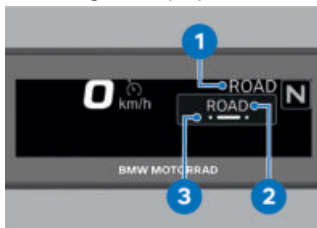

The riding mode currently active **1** is sent to the back and is displayed in the pop-up **2**. The guide **3** indicates how many riding modes are available.◁



• Repeatedly press button **1** until the riding mode you want is displayed.

» With the vehicle at a standstill, the selected mode is activated after approximately 2 seconds.

» The following conditions must be satisfied for activation of a new riding mode while riding:

—Throttle grip is in idle position.

—Brake is not applied.

—with cruise control^{OE}

» additionally:

—Cruise control is deactivated.◁

» The mode selected in this way is retained with the engine-characteristic, ABS and DTC adaptation settings even after the ignition has been switched off.

CRUISE CONTROL

—with cruise control^{OE}

Switching on cruise control



WARNING

Use of cruise control in unsuitable road conditions

Risk of falling

- Do not use cruise control when road conditions are unsuitable, for example in snow, ice, heavy rain, off-road or on slippery surfaces.
- Do not use cruise control on very twisty stretches of road.



- Slide switch **2** to the right.
» Button **1** is enabled for operation.

Setting road speed



- Short-push button **1** forward.



Adjustment range for cruise control (gear-dependent)

30...180 km/h



shows.

- » The motorcycle maintains your current cruising speed and the setting is saved.

Accelerating

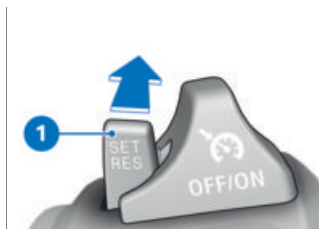

- Short-push button **1** forward.
» Speed is increased by approx. 1 km/h each time you push the button.

94 OPERATION

- Push button **1** forward and hold it in this position.
 - » The vehicle accelerates smoothly.
 - » The current speed is maintained and saved if button **1** is not pushed again.

Decelerating

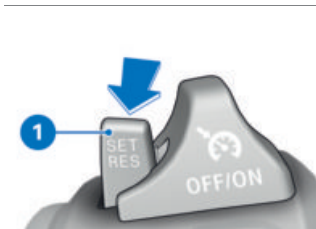

- Short-push button **1** back.
 - » Speed is reduced by approx. 1 km/h each time you push the button.
- Push button **1** back and hold it in this position.
 - » The vehicle decelerates smoothly.
 - » The current speed is maintained and saved if button **1** is not pushed again.

Deactivating cruise control

- Apply the brake or turn the throttle grip back past the idle position to deactivate cruise control.

 Cruise control is deactivated if the clutch is pulled for longer than 1.5 seconds.

 For safety reasons, cruise control is automatically deactivated whenever ABS or DTC intervention occurs. If DTC is deactivated by the rider, cruise control is deactivated as well.



disappears.

Automatic deactivation

Adaptive cruise control is deactivated automatically in the following situations:

- When engine speed drops below the minimum threshold (to prevent stalling).
- After several seconds when the vehicle is ridden at maximum engine speed.
- During ABS or DTC interventions.
- If a system fault occurs.

Resuming former cruising speed

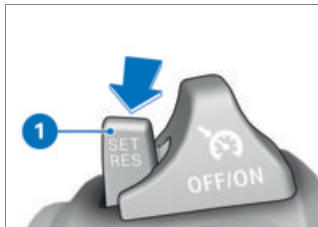

- Short-push button **1** back to return to the speed saved beforehand.

 Opening the throttle overrides cruise control briefly, without deactivating it. When the throttle twistgrip is released, speed drops back to the setting saved beforehand. If you want to reduce speed further you have to deactivate cruise control, for example by applying the brakes.



shows.

Switching off cruise control



- Slide switch **2** to the left.
 - » The system is deactivated.
 - » Button **1** is disabled.

Configure the character of cruise control

- Switch on the ignition.
 - ( 76)
 - without Digital Display^{OE}
 - Navigate to **SETUP, VEHICLE** and select **CRUISE CTL.**
 - Select the desired setting.
 - » The following settings for acceleration and deceleration are possible:
 - COMFORT:** Balanced acceleration and deceleration of the vehicle.
 - DYNAMIC:** More sharply pronounced acceleration and deceleration of the vehicle for a more dynamic style of riding.
- Select the desired setting.
 - with Digital Display^{OE}
 - Navigate to **SETUP, VEHICLE** and select **CRUISE CONTROL.**
 - Select the desired setting.

96 OPERATION

» The following settings for acceleration and deceleration are possible:

– **Comfortable:** Balanced acceleration and deceleration of the vehicle.

– **Dynamic:** More sharply pronounced acceleration and deceleration of the vehicle for a more dynamic style of riding.



HILL START CONTROL PRO (HSC PRO)

– with Hill Start Control^{OE}

Adjust Hill Start Control Pro

• Switch on the ignition.

(76)

– without Digital Display^{OE}

• Navigate to **SETUP, VEHICLE**.

• Select **HSC PRO**.

• To switch off Hill Start Control Pro, select **OFF**.

» Hill Start Control Pro is deactivated.

• To switch on manual Hill Start Control Pro, select **ON**.

» Hill Start Control Pro can be activated by forcefully operating the handbrake or footbrake lever.

• To switch on automatic Hill Start Control Pro, select **AUTO**.

» Hill Start Control Pro can be activated by forcefully oper-

ating the handbrake or footbrake lever.

- » If the brake is actuated for approximately one second after the vehicle has come to a standstill and the motorcycle is on a gradient of at least 3 %, Hill Start Control Pro is automatically activated.
- » The selected setting remains stored even after the ignition is switched off.◀

– with Digital Display^{OE}

• Navigate to **SETUP, VEHICLE**.

• Select **HSC PRO**.

• To switch off Hill Start Control Pro, select **Off**.

» Hill Start Control Pro is deactivated.

• To switch on manual Hill Start Control Pro, select **On**.

» Hill Start Control Pro can be activated by forcefully operating the handbrake or footbrake lever.

• To switch on automatic Hill Start Control Pro, select **Auto**.

» Hill Start Control Pro can be activated by forcefully operating the handbrake or footbrake lever.

» If the brake is actuated for approximately one second after the vehicle has come to a standstill and the motorcycle is on a gradient of at

- least 3 %, Hill Start Control Pro is automatically activated.
- » The selected setting remains stored even after the ignition is switched off.◁

Operating Hill Start Control Pro

Requirement

Vehicle stationary and upright, engine running.



ATTENTION

Non-availability of Hill Start Control

Risk of accident

- Apply the brakes manually to hold the vehicle.



Hill Start Control Pro is purely a comfort system that facilitates hill starts and consequently, is not to be confused with a parking brake.



Hill Start Control Pro should not be used on gradients steeper than 40 %.



- Apply firm pressure to handbrake lever **1** or to the footbrake lever and then quickly release the lever.
- Alternatively, apply the brake for about one second beyond the vehicle reaching a standstill on an incline of at least 3 %.



appears briefly.

—with Digital Display^{OE}



is displayed.◁

- » Hill Start Control Pro is activated.
- To switch off Hill Start Control Pro, operate handbrake lever **1** or the footbrake lever again.



If Hill Start Control Pro has been deactivated by means of the handbrake lever, automatic Hill Start Control is deactivated for the next 4 m.

98 OPERATION

 flashes briefly.

—with Digital Display^{OE}

 disappears.◀

- Alternatively, ride off in 1st or 2nd gear.

 In order for the motor-cycle to pull away from rest with Hill Start Control Pro, the throttle grip has to be turned to open the throttle for pullaway.

 flashes briefly as soon as the brake is fully released.

—with Digital Display^{OE}

 disappears as soon as the brake is fully released.◀

» Hill Start Control Pro is deactivated.

- See the "Engineering details" section for more information on Hill Start Control Pro (▮▮▮▮ 148).

TYRE PRESSURE MONITORING (RDC)

—with tyre pressure control (RDC)^{OE}

Switch the target-pressure warning on or off

- The system can be set to issue a target-pressure warning

if tyre pressure drops to the defined minimum.

—without Digital Display^{OE}

- Navigate to **SETUP, VEHICLE**.
- Switch **RDC WARN** on or off.◀

—with Digital Display^{OE}

- Navigate to **SETUP, VEHICLE**.
- Switch **RDC warning** on or off.◀

HEATED GRIPS

Grip heating not installed

 If grip heating is not installed and the button for this function is pressed, a message to the effect that the function is not available appears on the display.

Operating heated handlebar grips

—with heated grips^{OE}

 The heating in the heated handlebar grips can be activated only when the engine is running.

 The increase in power consumption caused by having the heated handlebar grips switched on can drain the battery if you are riding at low engine speeds. If the charge level is low, the heated handlebar grips are switched off to

ensure the battery's starting capability.

- Start the engine. (▶▶▶ 123)



- Repeatedly press button **1** until the desired heating stage is displayed.

—without Digital Display^{OE}

The following settings are available:



Heating off



Low heating power



Medium heating power



High heating power◀

—with Digital Display^{OE}

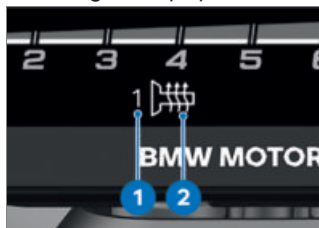

Selected heating stage **1** and seat-heating symbol **2** are displayed.◀

- » High heating power is for heating the grips quickly: it is advisable to switch back to a lower heating power as soon as the grips are warm.
- » The selected heating stage will be saved if you allow a certain length of time to pass without making further changes.

CONNECTEDRIDE CONTROL

—with ConnectedRide Control^{OE}

100 OPERATION

Securing smartphone in holder

ATTENTION

Vibrations when vehicle is moving

Damage to mobile phones carried on the vehicle

- Make sure that the mobile phone carried on the vehicle is suitable for use on the vehicle. Ask the manufacturer about related usage restrictions and comply with the information provided.



- Pull adjuster knob **1** out of holder **2**.
- Turn adjuster knob **1** counter-clockwise to open holder **2**.
- Place smartphone **3** centred in holder **2**.
- Turn adjuster knob **1** clockwise to close holder **2**.
- » Smartphone is secure in the holder.

- Push adjuster knob **1** into holder **2**.

Attaching smartphone holder



- Insert smartphone holder **2** into base plate **1**.
- Turn smartphone holder **2** through 90°.
- » Smartphone holder engages in base plate.
- Follow the instructions for charging via the USB charging interface (▮▮▮▮ 185).

Connect mobile device Requirement

The BMW Motorrad Connected app is installed on the mobile device.

- Switch on the ignition. (▮▮▮▮ 76)
- Navigate to **SETUP, SYSTEM** –without Digital Display^{OE}
- Call up **CONNECT .** and switch on **BLUETOOTH**.
- Select **TO PAIR**.

» The time remaining until the mobile device is connected is displayed.◀

—with Digital Display^{OE}

- Call up `Connections` and switch on `Bluetooth`.
- Select `Pair new device`.
- » The time remaining until the mobile device is connected is displayed.◀

- Activate the mobile device's Bluetooth function (see mobile device's operating instructions).

- Call up the BMW Motorrad Connected app.

- Connect a new device in the BMW Motorrad Connected app.

- Select `BMW_CR_Control` as the device and pair.

» The Bluetooth connection is established.

—with Digital Display^{OE}



is displayed.◀

- The BMW Motorrad Connected app can be operated by means of the Multi-Controller (▮▮▮▮▶ 101).

Multi-Controller

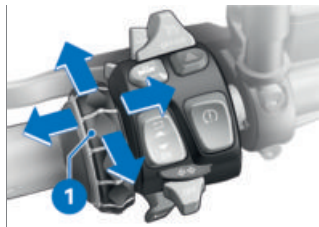

Precondition

The vehicle is connected via Bluetooth to a compatible mobile device.

The BMW Motorrad Connected app is installed on the connected mobile device.

Scroll Multi-Controller 1 up

—Move the cursor up in lists

Scroll Multi-Controller 1 down

—Move the cursor down in lists

Tilt Multi-Controller 1 to the right

—Activate function in accordance with feedback

—Confirm selection/setting

—Scrolling through menu screens

Tilt Multi-Controller 1 to the left

—Activate function in accordance with feedback or go back

—Change up one level in the hierarchy

102 OPERATION

–Scrolling through menu screens

SEAT

Removing seat

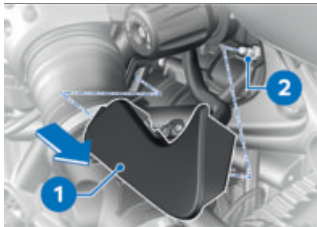

- Disengage cover **1** from holder **2** and remove it in the direction indicated by the arrow, noting the wiring of the diagnostic connector.



- Remove Torx wrench **1** with extension **2** from cover **3**.

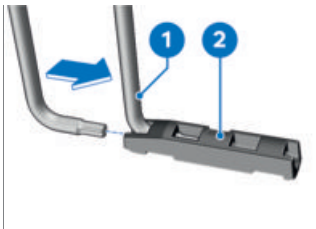

- Insert the short end of Torx wrench **1** into extension **2**.



- Remove rubber plug **2**.
- Remove screw **1** with the Torx wrench and extension.

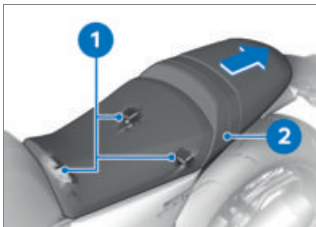

- Pull seat **2** out of lugs **1** and remove.

—with Option 719 Aluminium^{OE}

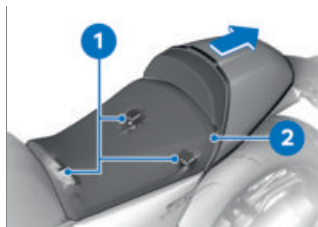

- Pull seat **2** out of lugs **1** and remove.◁

Installing seat

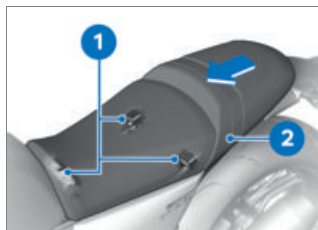

- Position seat **2** and push it into lugs **1**.

—with Option 719 Aluminium^{OE}

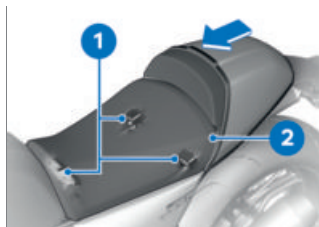

- Position seat **2** and push it into lugs **1**.◁



- Install screw **1** with the Torx wrench and extension.

 Seat lock to rear frame

M6 x 16

6 Nm

- Install rubber plug **2**.

104 OPERATION

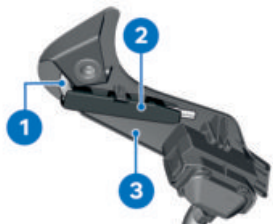

- Insert Torx wrench **1** with extension **2** into cover **3**.



- Insert cover **1** in the direction indicated by the arrow into holder **2** and press it into holder **3**, noting the wiring of the diagnostic connector.

ADJUSTMENT

06

MIRRORS	108
HEADLIGHT	109
CLUTCH	109
BRAKES	110
SPRING PRELOAD	111
DAMPING	114
GEARSHIFT LEVER	117

108 ADJUSTMENT

MIRRORS

Adjusting mirrors



- Turn the mirror to the correct position.

—with Option 719 Billet Pack Shadow II^{OE}



DANGER

Functional impairment due to incorrect installation position

Risk of crash and accident

- Do not change the installation position of the mirror.

- Turn the mirror head to the desired position.◁

Adjusting mirror arm



- Push protective cap **1** over the threaded fastener of the mirror arm up to expose the threaded fastener.
- Slacken nut **2**.
- Turn the mirror arm to the appropriate position.
- Tighten the nut to the specified torque, while holding the mirror arm to ensure that it does not move out of position.



Mirror (lock nut) to adapter

M10 x 1.25

22 Nm (Left-hand thread)

- Push protective cap **1** over the threaded fastener.

HEADLIGHT

Headlight adjustment for right-hand or left-hand traffic

This motorcycle has a symmetric-beam low-beam headlight. If the motorcycle is ridden in a country where the opposite rule of the road applies, its symmetric low-beam headlight means that no measures are necessary to prevent the headlight beam from dazzling oncoming traffic.

Headlight beam throw and spring preload

Headlight beam throw is kept constant when spring preload is adjusted to suit load.

 If there are doubts about the correct headlight beam throw, have the setting checked by a specialist workshop, preferably an authorised BMW Motorrad retailer.

CLUTCH

Adjusting clutch lever

WARNING

Relocated clutch-fluid reservoir

Air in the clutch system

- Do not turn the handlebars or the handlebar fitting on the handlebar.

WARNING

Adjusting the clutch lever while riding

Risk of accident

- Adjust the clutch lever only when the motorcycle is at a standstill.

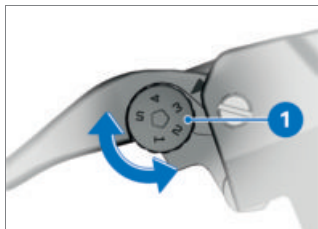

- Applying light pressure from behind, turn adjusting screw **1** to the desired position.

 The adjusting screw can be turned more easily if

110 ADJUSTMENT

the clutch lever is pushed forward.

» Adjustment options:

– From position 1: narrowest span between handlebar grip and clutch lever

– To position 5: widest span between handlebar grip and clutch lever

– with Option 719 Billet Pack Shadow II^{OE}

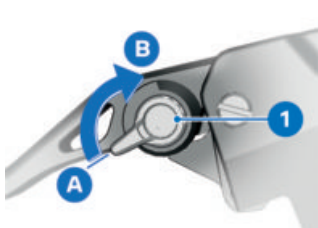

• Turn adjustment lever **1** to the desired position.

» Adjustment options:

– From position **A**: Narrowest span between handlebar grip and clutch lever.

– In 5 steps toward position **B** to increase the span between handlebar grip and clutch lever. ◀

BRAKES

Adjusting handbrake lever



WARNING

Relocated brake fluid tank

Air in the brake system

- Do not turn the handlebars or the handlebar fitting on the handlebar.



WARNING

Adjusting the handbrake lever while riding

Risk of accident

- Do not attempt to adjust the handbrake lever unless the vehicle is at a standstill.



- Applying light pressure from behind, turn adjusting screw **1** to the desired position.



The adjusting screw is easier to turn when the handbrake lever is pushed forward.

- » Adjustment options:
 - From position 1: narrowest span between handlebar grip and handbrake lever
 - To position 5: widest span between handlebar grip and handbrake lever
- with Option 719 Billet Pack Shadow II^{OE}

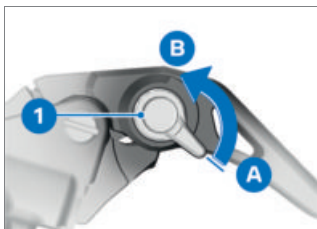

- Turn adjustment lever **1** to the desired position.
- » Adjustment options:
 - From position **A**: Narrowest span between handlebar grip and handbrake lever.
 - In 5 steps toward position **B** to increase the span between handlebar grip and handbrake lever. ◀

SPRING PRELOAD

Adjustment for front suspension

Front spring preload has to be adjusted to suit the rider's weight. Increase spring preload for heavy loads, decrease spring preload for light loads.

Adjusting spring preload for front wheel

- Make sure the ground is level and firm and place the motorcycle on its stand.
- Lift the motorcycle with an engine lifter until there is no load on the front wheel.

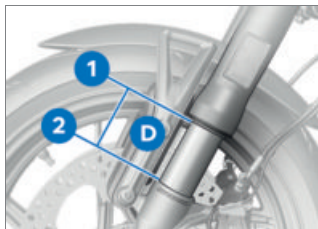

- Measure distance **D** between points **1** and **2**.
- Remove the engine lifter.
- Make sure the ground is level and firm and place the motorcycle on its stand.
- Apply the rider's weight to the motorcycle.
- With the assistance of a second person, measure

112 ADJUSTMENT

the distance **D** between the points **1** and **2** again and calculate the difference (compression) between the measured values.

 Load-dependent adjustment of spring preload

Negative spring displacement of front wheel

32 mm (with rider 95 kg)

 Basic setting of the front spring preload

Turn all the way counter-clockwise, then back off 5 turns clockwise (with full load of fuel, with rider weighing approx. 95 kg)

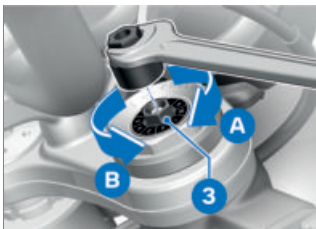

WARNING

Unmatched spring-preload and front-fork damping settings.

Impaired handling.

- Adjust the front-fork damping characteristic to suit spring preload.
- To reduce compression (increase spring preload), use the tool from the on-board toolkit to turn adjusting screw **3** in direction **A**. The toolkit includes an appropriate adapter that protects the screw from scratches.
- To increase compression (reduce spring preload), use the tool from the on-board toolkit to turn adjusting screw **3** in direction **B**. The toolkit includes an appropriate adapter that protects the screw from scratches.

Adjustment for rear suspension

It is essential to set spring preload of the rear suspension to suit the load carried by the motorcycle. Increase spring preload when the vehicle is heavily loaded and reduce spring preload accordingly when the vehicle is lightly loaded.

Adjusting spring preload for rear wheel

- Make sure the ground is level and firm and place the motorcycle on its stand.

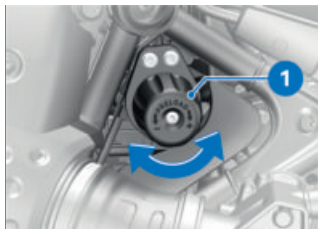

WARNING

Spring preload setting and spring-strut damping setting not matched.

Impaired handling.

- Adjust spring-strut damping to suit spring preload.

- If you want to increase spring preload, turn adjuster knob **1** clockwise.
- If you want to reduce spring preload, turn adjuster knob **1** counter-clockwise.



Basic setting of the rear spring preload

Turn all the way counter-clockwise, then back off 6 turns clockwise (with full load of fuel, with rider weighing approx. 95 kg)

Turn all the way counter-clockwise, then back off 12 turns clockwise (One-up with luggage approx. 105 kg)

Turn all the way counter-clockwise, then back off 22 turns clockwise (Two-up with luggage approx. 165 kg)

- Adjust the damping characteristic to suit spring preload.



See the section on suspension in "Technical data" for a recommendation on how to set up the suspension.

- Adjust rebound-stage damping for rear wheel. (►► 116)

114 ADJUSTMENT

DAMPING

Effects of damping on handling.

The aim of adjusting this setting is to adapt the damping to suit the spring preload, road conditions, desired handling/drivability and load state.

Increased compression-stage damping

- Direct handling/drivability.
- Increased response to road conditions.
- Loss of comfort on bumpy or uneven road surfaces.

Reduced compression-stage damping

- Comfortable handling/drivability.
- Reduced response to road conditions.
- Increased vibration tendency.

Increased rebound-stage damping

- Direct handling/drivability.
- Increased response to road conditions.
- Reduced vibration tendency.
- Loss of comfort when driving over series of bumps.

Reduced rebound-stage damping

- Comfortable handling/drivability.
- Reduced response to road conditions.
- Increased vibration tendency.

Adjusting compression-stage damping for front wheel



- Prepare the screwdriver from the on-board toolkit. (▶▶▶ 153)
- Adjust compression-stage damping by turning adjusting screw **1** on the left fork leg.



- To increase damping: Use the tool from the on-board toolkit to turn the adjusting screw so

that mark **1** points to a higher value on the scale.

- To reduce damping: Use the tool from the on-board toolkit to turn the adjusting screw so that mark **1** points to a lower value on the scale.



Compression stage, basic setting, front

Position 1 (comfortable setting with rider 95 kg)

Position 5 (normal setting with rider 95 kg)

Position 8 (sports setting with rider 95 kg)

Adjusting rebound-stage damping for front wheel



- Prepare the screwdriver from the on-board toolkit. (▮▮▮▮▶ 153)
- Adjust rebound-stage damping by turning adjusting screw **1** on the right fork leg.



- To increase damping: Use the tool from the on-board toolkit to turn the adjusting screw so that mark **1** points to a higher value on the scale.
- To reduce damping: Use the tool from the on-board toolkit to turn the adjusting screw so that mark **1** points to a lower value on the scale.



Rebound stage, basic setting, front

Position 1 (comfortable setting with rider 95 kg)

Position 5 (normal setting with rider 95 kg)

Position 8 (sports setting with rider 95 kg)

Restoring factory defaults at front wheel

- Reset the factory defaults as stated below.

116 ADJUSTMENT



Factory default settings
for compression/re-
bound stages, front

Position 5

Adjust the rebound-stage damping for rear wheel

- Make sure the ground is level and firm and place the motorcycle on its stand.

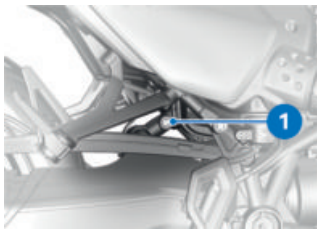

- Prepare the screwdriver from the on-board toolkit. (▣▣▣ 153)
- Adjust the damping characteristic, using the tool from the on-board toolkit to turn adjusting screw **1**.

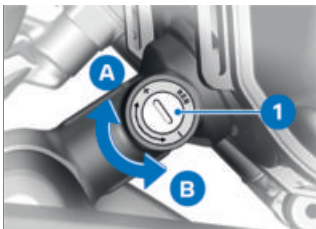

- To increase damping: Use the tool from the on-board toolkit to turn adjusting screw **1** in direction **A**.
- To reduce damping: Use the tool from the on-board toolkit to turn adjusting screw **1** in direction **B**.



Basic setting of rear-
suspension damping
characteristic

Turn the adjusting screw clockwise as far as it will go, then back it off 6 full turns (One-up riding)

Turn the adjusting screw clockwise as far as it will go, then back it off 4 turn (One-up with luggage)

Turn the adjusting screw clockwise as far as it will go, then back it off 4 turn (Two-up riding)



Basic setting of rear suspension damping characteristic

Turn the adjusting screw clockwise as far as it will go, then back it off 2 turn (Two-up with luggage)

the gearshift shaft and push it on to gearshift shaft **2**.

- Install screw **3**.



Gearshift lever to selector shaft

M6 x 25

8 Nm

GEARSHIFT LEVER

ATTENTION

Unintentional operation of the gearshift lever

Damage to the gearbox

- Check that the gearshift lever is in the correct position.
- Make sure that the gearshift lever is under no load except when gearshifting is in progress.

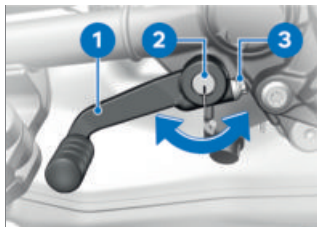

- Remove screw **3**.
- Disengage gearshift lever **1** from gearshift shaft **2**.
- Hold gearshift lever **1** in the desired position relative to

RIDING

07

SAFETY INFORMATION	120
REGULAR CHECK	123
STARTING	123
RUNNING IN	125
SHIFTING GEAR	125
BRAKES	126
PARKING YOUR MOTORCYCLE	129
REFUELLING	130
SECURING MOTORCYCLE FOR TRANSPORTATION	132

SAFETY INFORMATION

Rider's equipment

Do not ride without the correct clothing! Always wear

- Helmet
- Suit
- Gloves
- Boots

This applies even to short journeys, and to every season of the year. Your authorised BMW Motorrad retailer will be happy to advise you on the correct clothing for every purpose.



WARNING

Loose textiles, items of luggage or straps snagged by open rotating parts of the vehicle (wheels, drive shaft)

Risk of accident

- Make sure that loosely worn or carried textiles cannot be snagged by openly rotating parts of the vehicle.
- Keep all items of luggage and straps well clear of openly rotating parts of the vehicle.

Load



WARNING

Handling adversely affected by overloading and imbalanced loads

Risk of falling

- Do not exceed the permissible gross weight and be sure to comply with the instructions on loading.
 - Set spring preload, damping characteristic and tyre pressures to suit total weight.
 - Adjust tyre pressures to suit total weight.
 - Pack heavy items at the bottom and toward the inboard side.
 - with tank bag^{OA}
 - Note the maximum permissible payload of the tank bag (►► 187).◀
 - with rear softbag^{OA}
 - Note the maximum permissible payload of the rear bag (►► 187).◀
- ### Speed
- Drive cold tyres warm with care to extend the service life of your tyres and ensure optimum road adhesion. Avoid powerful acceleration on cold tyres. Slowly increase lean

angles while driving the tyres warm.

 To prevent the tyres from overheating and to extend the service life of your tyres, avoid driving at maximum speed for long periods.

If you ride at high speed, always bear in mind that various boundary conditions can adversely affect the handling of your motorcycle. They include:

- Settings of the spring-strut and shock-absorber system
- Imbalanced load
- Loose clothing
- Insufficient tyre pressure
- Poor tyre tread

Top speed

DANGER

Top speed of the motorcycle higher than the permissible tyre maximum speed

Risk of accident due to tyre damage at high speed

- Do not exceed the maximum speed for which the tyres are rated.

Always bear the maximum permissible speed of the tyres in mind when riding a motorcycle fitted with winter tyres.

Affix a label stating the maximum permissible speed to the instrument panel in the rider's field of vision.

Risk of poisoning

Exhaust fumes contain carbon monoxide, which is colourless and odourless but highly toxic.

WARNING

Exhaust gases adversely affecting health

Risk of asphyxiation

- Do not inhale exhaust fumes.
- Do not run the engine in an enclosed space.

WARNING

Inhalation of harmful vapours

Health hazard

- Do not inhale vapours from operating fluids and plastics.
- Use the vehicle only outdoors.

122 RIDING

Risk of burning



CAUTION

Engine and exhaust system become very hot when the vehicle is in use

Risk of burning

- Always wear helmet, suit, gloves and boots.
- While riding and when you park the vehicle, make sure that no-one and no objects come into contact with the hot engine and exhaust system.

Catalytic converter



ATTENTION

Unburned fuel in catalytic converter

Damage to catalytic converter

- Note the points listed for protection of the catalytic converter.

If misfiring causes unburned fuel to enter the catalytic converter, there is a danger of overheating and damage. The following guidelines must be observed:

- Do not run the fuel tank dry.
- Do not attempt to start or run the engine with a spark-plug cap disconnected.
- Stop the engine immediately if it misfires.
- Use only unleaded fuel.
- Comply with all specified maintenance intervals.

Risk of overheating



ATTENTION

Engine running for prolonged period with vehicle at standstill

Overheating due to insufficient cooling; in extreme cases vehicle fire

- Do not allow the engine to idle unnecessarily.
- Ride away immediately after starting the engine.

Tampering



ATTENTION

Tampering with the motorcycle (e.g. engine management ECU, throttle valves, clutch)

Damage to the affected parts, failure of safety-relevant functions, voiding of warranty

- Do not tamper with the vehicle in any way that could result in tuned performance.

REGULAR CHECK

Comply with checklist

At regular intervals, use the checklist below to check your motorcycle.

Always before riding off

- Check operation of the brake system (▶▶▶▶ 156).
- Check operation of the lights and signalling equipment.
- Check operation of the clutch (▶▶▶▶ 161).
- Check the tyre tread depth (▶▶▶▶ 162).
- Check the tyre pressures (▶▶▶▶ 162).
- Check security of luggage.

Every 3rd refuelling stop

- Check the engine oil level (▶▶▶▶ 154).
- Check the brake pad thickness, front brakes (▶▶▶▶ 156).
- Check the brake pad thickness, rear brakes (▶▶▶▶ 157).
- Check the brake-fluid level, front brakes (▶▶▶▶ 159).
- Check the brake-fluid level, rear brakes (▶▶▶▶ 160).

STARTING

Starting engine

- Switch on the ignition. (▶▶▶▶ 76)
- » Pre-Ride-Check and self-diagnoses are performed. (▶▶▶▶ 124)
- Select neutral or, if a gear is engaged, pull the clutch lever.



You cannot start the motorcycle with the side stand extended and a gear engaged. The engine will switch itself off if you start it with the gearbox in neutral and then engage a gear before retracting the side stand.



To ensure rapid operational readiness of the catalytic converter, idle speed is increased for a short time after engine start.

- Cold starts and low temperatures:

124 RIDING

» Pull the clutch lever.



- Press starter button **1** and hold it down until the engine fires.

 The start attempt is automatically interrupted if battery voltage is too low. Recharge the battery before you start the engine, or use jump leads and a donor battery to start.

See the subsection on jump starting in "Maintenance" for more details.

» Consult the troubleshooting chart below if the engine refuses to start. (▶▶▶ 200)

Recharge the battery before you try again to start the engine, or use jump leads and a donor battery to start:

- Recharge the battery. (▶▶▶ 176)
- Jump-start. (▶▶▶ 173)

 The start attempt is automatically interrupted if battery voltage is too low.

Pre-Ride-Check and self-diagnosis

The instrument cluster runs a test of the instruments and the indicator and warning lights when the ignition is switched on. During the Pre-Ride-Check, all indicator and warning lights show temporarily.

» Self-diagnosis checks the functional readiness of the BMW Motorrad ABS and the BMW Motorrad ASC/DTC.



flashes.



slow-flashes.

» The indicator and warning lights go out when a speed of 5 km/h is reached.

» Self-diagnosis has completed.

If an error message appears when self-diagnosis completes:

- Have the fault rectified as quickly as possible by a specialist workshop, preferably an authorised BMW Motorrad retailer.

RUNNING IN

Engine

- Until the first running-in check, vary the throttle opening and engine-speed range frequently; avoid riding at constant engine rpm for prolonged periods.
- Try to do most of your riding during this initial period on twisting, fairly hilly roads.
- Comply with the running-in speeds.



Running-in speed

<5000 min⁻¹ (Odometer reading 0...1000 km)

- Note the mileage after which the running-in check should be carried out.



Mileage until the first running-in check

500...1200 km

Brake pads



WARNING

New brake pads

Longer stopping distance, risk of accident

- Apply the brakes in good time.

New brake pads have to be run in before they can achieve their optimum frictional force. You can compensate for this initial reduction in braking efficiency by exerting greater pressure on the levers.

Tyres

New tyres have a smooth surface. This must be roughened by riding in a restrained manner at various heel angles until the tyres are run in. This running in procedure is essential if the tyres are to achieve maximum grip.

Read the tyre manufacturer's information on how to run in new tyres correctly.



WARNING

New tyres losing grip on wet roads and at extreme bank angles

Risk of accident

- Ride carefully and avoid extremely sharp inclines.

SHIFTING GEAR

—with shift assistant Pro^{OE}

Gear Shift Assistant Pro

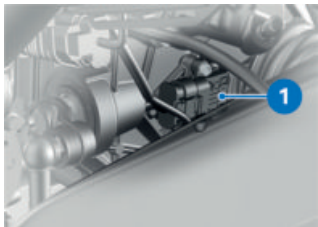

- Select the gears in the usual way by using the foot-operated gearshift lever.
 - » The shift assistant assists upshifts and downshifts without the rider having to pull the clutch or close the throttle.
 - This is not an automatic-shift system.
 - The rider is the most important part of the system and decides when to shift gears.
 - The sensor **1** on the gearshift shaft registers the gearshift request and triggers shift assistance.
 - » When you are riding at constant speed or in overrun in a low gear with the engine revving high, shifting gear without disengaging the clutch can cause a severe reaction to the load change. BMW Motorrad recommends disengaging the clutch for shifts in these circumstances.
- » Shift assistance is not available in the following situations:
 - With clutch lever pulled.
 - Gearshift lever not in its initial position
 - Once the gearshift has completed, the gearshift lever has to be fully released before another gearshift with the Pro can take place.
 - For more information on Gear Shift Assistant Pro see the section headed "Engineering details" (▶▶▶ 146).

BRAKES

How can stopping distance be minimised?

Each time the brakes are applied, a load distribution shift takes place with the load shifting forward from the rear to the front wheel. The sharper the motorcycle decelerates, the more load is shifted to the front wheel. The higher the wheel load, the more braking force can be transmitted without the wheel locking. To optimise stopping distance, apply the front brakes rapidly and keep on increasing the force you apply to the brake lever. This makes the best possible use of the dynamic

increase in load at the front wheel. Remember to pull the clutch at the same time. In the extreme sudden-stop braking situations that are trained so frequently, braking force is applied as rapidly as possible and with the rider's full force applied to the brake levers; under these circumstances the dynamic shift in load distribution cannot keep pace with the increase in deceleration and the tyres cannot transmit the full braking force to the surface of the road.

BMW Motorrad Integral ABS Pro prevents the front wheel from locking up.



WARNING

Rear wheel lift due to severe braking

Risk of falling

- When you brake sharply, bear in mind that ABS control cannot always be relied on to prevent the rear wheel from lifting clear of the ground.

Emergency braking

If the motorcycle is braked sharply at a sufficient speed, the brake light flashes rapidly to warn following road users. If you brake until your speed is less than <15 km/h, the hazard warning lights start to flash as well. The hazard warning lights switch off automatically as soon as you start to accelerate and vehicle speed reaches 20 km/h.

Descending mountain passes



WARNING

Braking mostly with the rear brake on mountain descents

Brake fade, destruction of the brakes due to overheating

- Use both front and rear brakes, and make use of the engine's braking effect as well.



DANGER

Riding with overheated brakes

Risk of accident due to failure of brakes

- Adapt your riding style accordingly.
- Avoid frequent braking by using the engine brake.



WARNING

Failure to observe service intervals

Risk of accident

- Observe the valid service intervals for brakes.

Wet and dirty brakes



WARNING

Wetness and dirt result in diminished braking efficiency

Risk of accident

- Apply the brakes lightly while riding to remove wetness and dirt, or dismount and clean the brakes.
- Think ahead and brake in good time until full braking efficiency is restored.

Wetness and dirt on the brake discs and the brake pads diminish braking efficiency.

Delayed braking action or poor braking efficiency must be reckoned with in the following situations:

- Riding in the rain or through puddles of water.
- After the vehicle has been washed.
- Riding on salted or gritted roads.
- After work has been carried on the brakes, due to traces of oil or grease.
- Riding on dirt-covered surfaces or off-road.

ABS Pro

Physical limits applicable to motorcycling



WARNING

Braking when cornering

Risk of crash despite ABS Pro

- Invariably, it remains the rider's responsibility to adapt riding style to riding conditions.
- Do not take risks that would negate the additional safety offered by this system.

Possibility of a fall not precluded

Although ABS Pro and Dynamic Brake Control provide the rider with valuable assistance and constitute a huge advance in safety for braking with the motorcycle banked for cornering, they cannot under any circumstances be considered as re-defining the physical limits that apply to motorcycling. It is still possible for these limits to be overshoot due to misjudgement or rider error. In extreme cases this can result in a crash.

Use on public roads

ABS Pro and Dynamic Brake Control help make the motorcycle even safer for riding on public roads. When the brakes are applied because of an unforeseen hazard when the motorcycle is banked for cornering, within the physical limits that apply to motorcycling the ABS Pro system prevents the wheels from locking and skidding away. In emergency braking, Dynamic Brake Control increases the braking effect and intervenes if the throttle grip is accidentally turned during braking.

 ABS Pro was not developed to enhance individual braking performance with the motorcycle banked into corners.

PARKING YOUR MOTORCYCLE

Side stand

- Switch off the engine.



ATTENTION

Poor ground underneath the stand

Risk of damage to parts if vehicle topples

- Always check that the ground under the stand is level and firm.



ATTENTION

Additional weight placing strain on the side stand

Risk of damage to parts if vehicle topples

- Do not sit or lean on the vehicle while it is propped on the side stand.
- Extend the side stand and prop the motorcycle on the stand.
- If the camber of the roadway permits, turn the handlebars all the way to the left.

130 RIDING

- On a gradient, the motorcycle should always face uphill; select 1st gear.

REFUELLING

Fuel grade

Requirement

For optimum fuel consumption, fuel should be sulphur-free or as low-sulphur as possible.



ATTENTION

Engine operation with leaded fuel

Damage to catalytic converter

- Do not attempt to run the vehicle on leaded fuel or fuel with metallic additives (e.g. manganese or iron).
 - Observe the maximum ethanol content of the fuel.
-  Fuel additives clean the fuel injection system and the combustion zone. It is advisable to use fuel additives when the engine is operated with low-grade fuel or if the vehicle is to be out of use for a lengthy period of time. More information is available from your authorised BMW Motorrad retailer.



Recommended fuel grade



Premium unleaded (maximum 15 %



ethanol, E15)
95 ROZ/RON
90 AKI



Alternative fuel grade



Regular unleaded (maximum 15 % ethanol,



E15)
91 ROZ/RON
87 AKI

» Look for these symbols on the fuel filler cap and on the fuel pump:



Refuelling



WARNING

Fuel is highly flammable

Risk of fire and explosion

- Do not smoke. Never bring a naked flame near the fuel tank.

**WARNING**

Escape of fuel due to heat-induced expansion if fuel tank is overfilled

Risk of falling

- Do not overfill the fuel tank.

**ATTENTION**

Component damage

Component damage caused by overfilled fuel tank

- Overfilling the fuel tank will cause excess fuel to penetrate the carbon canister and cause component damage.
- Fill the fuel tank up to the lower edge of the filler neck only.

**ATTENTION**

Wetting of plastic surfaces by fuel

Damage to the surfaces (surfaces become unsightly or dull)

- Clean plastic surfaces immediately after contact with fuel.
- Make sure the ground is level and firm and place the motorcycle on its stand.



- Open the protective cap **2**.
- Use the vehicle key to unlock filler cap of fuel tank **1** by turning it clockwise, and flip the cap open.

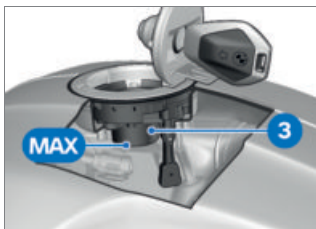

- Refuel with fuel of the grade stated above; do not fill the tank past the bottom edge of filler neck **3**.



When refuelling after running on reserve, make sure that you top up the tank to a level above reserve, so that the new level is detected and the fuel reserve indicator light is switched off.

132 RIDING

 The "usable fuel capacity" specified in the technical data is the quantity that the fuel tank could hold if refilled after it had been run dry and the engine had cut out due to a lack of fuel.



Usable fuel capacity

approx. 16 l



Reserve fuel

approx. 3.5 l

- Press the fuel filler cap down firmly to close.
- Remove the key and close the protective cap.

SECURING MOTORCYCLE FOR TRANSPORTATION

- Make sure that all components that might come into contact with straps used to secure the motorcycle are adequately protected against scratching. Use adhesive tape or soft cloths, for example, for this purpose.



ATTENTION

Vehicle topples to side when being lifted on to stand

Risk of damage to parts if vehicle topples

- Secure the vehicle to prevent it toppling, preferably with the assistance of a second person.
- Push the motorcycle onto the transportation flat and hold it in position: do not place it on the side stand.
- Have a helper hold the motorcycle to make sure that it cannot topple.



ATTENTION

Trapping of components

Component damage

- Do not trap components such as brake lines or cable legs.
- At the front, secure the tensioning straps to the bottom fork bridge on both sides.



- At the rear, secure the straps to the rear frame on both sides and tighten the straps.

—with two-up riding package^{OE}



- At the rear, secure the tensioning straps to the brackets of the rear footrest on both sides and tension them.◁
- Uniformly tighten all the straps.
- » The vehicle's springs are compressed.

ENGINEERING DETAILS

08

GENERAL NOTES	136
ANTILOCK BRAKE SYSTEM (ABS)	136
DYNAMIC TRACTION CONTROL (DTC)	139
DYNAMIC ENGINE BRAKE CONTROL (MSR)	141
BATTERY GUARD	142
RIDING MODE	142
DYNAMIC BRAKE CONTROL	144
TYRE PRESSURE CONTROL (RDC)	145
GEAR SHIFT ASSISTANT	146
HILL START CONTROL PRO (HSC PRO)	148
CORNERING HEADLIGHT	149

GENERAL NOTES

To find out more about engineering, go to:

bmw-motorrad.com/technik

ANTILOCK BRAKE SYSTEM (ABS)

Partially integral brakes

Your motorcycle is equipped with partially integral brakes. Both front and rear brakes are applied when you pull the handbrake lever. The foot-brake lever acts only on the rear brake.



ATTENTION

Attempted burn-out despite Integral braking function

Damage to rear brake and clutch

- Do not burn out tyres.

How does ABS work?

The amount of braking force that can be transferred to the road depends on factors that include the coefficient of friction of the road surface. Loose stones, ice and snow or a wet road all have much lower coefficients of friction than a clean and dry asphalt surface. The lower the coefficient of friction,

the longer the stopping distance.

If the rider increases braking pressure to the extent that braking force exceeds the maximum transferable limit, the wheels start to lock and the vehicle loses its directional stability: A fall is imminent. Before this situation can occur, ABS intervenes and adapts braking pressure to the maximum transferable braking force. The wheels continue to turn and the driving stability is retained irrespective of the road condition.

What are the effects of surface irregularities?

Surface irregularities can cause the wheels to lose contact temporarily with the road surface. If this happens the braking force that can be transmitted to the road can drop to zero. If the brakes are applied under these circumstances the ABS has to reduce braking force to ensure that directional stability is maintained when the wheels regain contact with the road surface. At this instant the ABS must assume an extremely low coefficient of friction (gravel, ice, snow), so that the wheels will continue to rotate under all imaginable circumstances, be-

cause this is the precondition for ensuring directional stability. As soon as it registers the actual circumstances, the system reacts instantly and adjusts braking force accordingly to achieve optimum braking.

What feedback does the rider receive from the BMW Motorrad Integral ABS?

If ABS has to reduce braking force on account of the circumstances described above, vibration is perceptible through the handbrake lever.

When the handbrake lever is pulled, brake pressure is also built up at the rear wheel by the integral function. If the brake pedal is depressed after the handbrake lever is pulled, the brake pressure built up beforehand is perceptible as counter-pressure sooner than is the case when the brake pedal is depressed either before or at the same time as the brake lever is pulled.

Rear wheel lift

Under very severe and sudden deceleration, however, it is possible that the BMW Motorrad ABS will be unable to prevent the rear wheel from lifting clear of the ground.

If this happens the outcome can be a highsiding situation in which the motorcycle can flip over.



WARNING

Rear wheel lift due to severe braking

Risk of falling

- When you brake sharply, bear in mind that ABS control cannot always be relied on to prevent the rear wheel from lifting clear of the ground.

What is the design baseline for BMW Motorrad ABS?

Within the limits imposed by physics, the BMW Motorrad ABS ensures directional stability on any surface.

At speeds above min. 4 km/h, within the limits imposed by physics the BMW Motorrad ABS can ensure directional stability on any surface. Limitations inherent to the design principle mean that at lower speeds the BMW Motorrad ABS cannot provide optimum assistance on all surfaces.

138 ENGINEERING DETAILS

The system is not optimised for special requirements that apply under extreme competitive conditions off-road or on the track.

Special situations

The speeds of the front and rear wheels are compared as one means of detecting a wheel's incipient tendency to lock. If the system registers implausible values for a lengthy period the ABS function is deactivated for safety reasons and an ABS fault message is issued. Self-diagnosis has to complete before fault messages can be issued. In addition to problems with the BMW Motorrad ABS, exceptional riding conditions can lead to a fault message being issued:

- Riding for a lengthy period with the front wheel lifted off the ground (wheelie).
- Rear wheel rotating with the vehicle held stationary by application of the front brake (burn-out).
- Heating up with the motorcycle on the centre stand or an auxiliary stand, engine idling or with a gear engaged.

- Rear wheel locked for a lengthy period, for example while descending off-road.

If a fault message is issued on account of exceptional riding conditions, you can reactivate the ABS function by switching the ignition off and on again.

How important is regular maintenance?



WARNING

Brake system not regularly serviced

Risk of accident

- In order to ensure that the BMW Motorrad ABS is always maintained in optimum condition, it is essential for you to comply strictly with the specified inspection intervals.

Safety reserves

The potentially shorter braking distances which BMW Motorrad Integral ABS permits must not be used as an excuse for careless riding. The system is primarily a means of ensuring a safety margin in genuine emergencies.



WARNING

Braking when cornering

Risk of accident despite ABS

- Invariably, the rider bears responsibility for assessing road and traffic conditions and adopting his or her style of riding accordingly.
- Do not take risks that would negate the additional margin of safety offered by this system.

ABS Pro

ABS Pro increases safety, particularly for braking with the machine banked over in bends. ABS Pro prevents the wheels from locking even under sharp braking. ABS Pro reduces abrupt changes in steering force, particularly in shock-braking situations, counteracting the vehicle's otherwise natural but undesirable tendency to straighten up.

ABS intervention

Technically speaking, depending on the riding situation ABS Pro adapts ABS intervention to the motorcycle's bank angle. Signals for rate of roll and rate of yaw and lateral acceleration are used

to calculate bank angle. They come from the angular rate sensor, an integral component of Dynamic Traction Control (DTC).

As the motorcycle is heeled over more and more as it banks into a corner, an increasingly strict limit is imposed on the brake-pressure gradient for the start of brake application. This slows the build-up of brake pressure to a corresponding degree. Additionally, pressure modulation is more uniform across the range of ABS intervention.

Advantages for the rider

The advantages of ABS Pro for the rider are sensitive response and high braking and directional stability combined with best-case deceleration of the motorcycle, even when cornering.

DYNAMIC TRACTION CONTROL (DTC)

How does traction control work?

Traction control compares the front and rear wheel circumferential velocities. The differential is used to compute slip as a measure of the re-

serves of stability available at the rear wheel. If slip exceeds a certain limit, the electrical machine management system intervenes and adapts torque accordingly. Dynamic Traction Control (DTC) takes the lean angle into consideration and uses this additional lean angle and acceleration data to regulate traction more precisely and comfortably.

BMW Motorrad DTC is designed as an assistant system for the rider and for use on public roads. The extent to which the rider affects DTC control can be considerable (weight shifts when cornering, items of luggage loose on the vehicle), especially when the style of riding takes rider and machine close to the limits imposed by physics.

The system is not optimised for special requirements that apply under extreme competitive conditions off-road or on the track. The BMW Motorrad DTC can be deactivated in these cases.



WARNING

Risky riding

Risk of accident despite DTC

- Invariably, the rider bears responsibility for assessing road and traffic conditions and adopting his or her style of riding accordingly.
- Do not take risks that would negate the additional safety offered by this system.

Special situations

In accordance with the laws of physics, the ability to accelerate is restricted more and more as the angle of heel increases. Consequently, there can be a perceptible reduction in acceleration out of very tight bends.

If the electronic processor receives values for the bank angle that it considers implausible over a lengthy period, a dummy value is used for the bank angle or the DTC function is switched off. Under these circumstances the indicator for a DTC fault shows. Self-diagnosis has to complete before fault messages can be issued.

Traction control can shut down automatically under the excep-

tional riding conditions outlined below.

Exceptional riding conditions:

- Riding for a lengthy period with the front wheel lifted off the ground (wheelie).
- Rear wheel rotating with the vehicle held stationary by application of the front brake (burn-out).
- Heating up with the motorcycle on an auxiliary stand, in neutral or with a gear engaged.

If the front wheel lifts clear of the ground under severe acceleration, DTC either as a function of the riding mode or the DTC setting reduces engine torque until the front wheel regains contact with the ground. BMW Motorrad recommends turning the throttle grip back slightly when lifting the front wheel in order to reach a stable driving condition again as soon as possible.

DYNAMIC ENGINE BRAKE CONTROL (MSR)

How does dynamic engine brake control work?

The purpose of dynamic engine brake control is to prevent the unstable riding states that can be produced by excessive engine braking moment acting on the rear wheel. Depending on the road condition and riding dynamic, excessive braking torque can produce a sharp rise in rear-wheel slip and impair directional stability. Dynamic engine brake control limits this slip at the rear wheel to a safe, mode-dependent regulated slip.

Causes for excessive slip at the rear wheel:

- Riding with engine overrun on a surface with a low coefficient of friction (e.g. wet leaves).
- Rear-wheel hop when rider downshifts.
- Sharp braking during sporty riding.

In the same way as DTC traction control, dynamic engine brake control compares the wheel circumferential velocities of the front and rear wheels. Additional information on the

142 ENGINEERING DETAILS

bank angle enables dynamic engine brake control to calculate slip and the reserve of stability at the rear wheel.

If slip overshoots the applicable limit value, the throttle valves are opened very slightly to increase engine torque. Slip is reduced and the vehicle is stabilised.

BATTERY GUARD

What is the Battery Guard?

The Battery Guard monitors the battery's state of charge and battery voltage. The Battery Guard helps prevent deep discharge of the battery and enables appropriate recharging in accordance with the drain on the battery.

How does Battery Guard work?

As long as the vehicle is switched off, the state of charge or the voltage of the battery is checked once a day. If the system ascertains that the values measured in this way are too low, a warning message is issued after the ignition is switched on. Depending on the availability of BMW Motorrad Teleservices, warning messages can also be transmitted by electronic noti-

fication. More detailed information about the BMW Motorrad Teleservices is available from your authorised BMW Motorrad retailer.

Battery Guard has multi-sage reaction:

–**Low state of charge:** 12 V socket is activated. A charger connected to this socket can recharge the battery.

In combination with BMW Motorrad Teleservices:

–**Low state of charge:** Every three days, a warning message prompting for the battery to be recharged is transmitted.

–**Critical state of charge:** Every day, a warning message prompting for the battery to be recharged is transmitted.

RIDING MODE

Selection

To adjust the motorcycle to the road condition and the desired driving experience, the following riding modes can be selected:

- RAIN
- ROAD
- DYNAMIC

For each of these riding modes, there is a matching setting for the DTC, ABS and MSR systems and for the engine characteristic.

DTC can be switched off in each riding mode. The explanations below always refer to the dynamic safety systems that are switched on.

Throttle response

- In RAIN riding mode: Restrained
- In ROAD riding mode: Optimum
- In DYNAMIC riding mode: Direct

ABS

- In ROAD and DYNAMIC riding modes, the ABS setting corresponds to the selected riding mode.
- In RAIN riding mode, the ABS setting corresponds to the ROAD riding mode.

Rear-wheel lift-off detection

- In RAIN and ROAD riding modes, the rider has maximum assistance from rear-wheel lift-off detection.
- In DYNAMIC riding mode, rear-wheel lift-off detection offers reduced assistance and

allows slight lift-off of the rear wheel.

ABS Pro

- In RAIN, ROAD and DYNAMIC riding modes, ABS Pro is fully available.
- In DYNAMIC riding mode, the assistance of ABS Pro is less than in RAIN and ROAD riding modes.

Brake force distribution

Application of the front wheel brake

- In RAIN and ROAD riding modes, maximum possible brake force is distributed to the rear wheel.
- In DYNAMIC riding mode, less brake force is distributed to the rear wheel than in RAIN and ROAD riding modes.

DTC

Riding stability

- In the DTC setting RAIN, DTC intervenes early enough to achieve maximum riding stability.
- In the DTC setting ROAD, DTC intervenes later than in the RAIN riding mode. This prevents the rear wheel from spinning whenever possible.
- In the DTC settings RAIN and ROAD, the front wheel is pre-

144 ENGINEERING DETAILS

vented from lifting off the ground.

- In the DTC setting DYNAMIC, DTC intervenes later than in the DTC setting ROAD, so slight drift can be induced when exiting corners and brief wheelies are also possible.

Effect of dynamic engine brake control

- In RAIN and ROAD riding modes: Maximum stability.
- In DYNAMIC riding mode: High stability.

Mode changes

The riding mode can be changed while the vehicle is stationary with the ignition on. Under the following precondition, it is also possible to change modes while riding:

- No drive torque on the rear wheel.
- No brake pressure in the brake system.

The following steps must be taken to change the riding mode:

- Close the throttle twistgrip.
- Release the brake levers.

- with cruise control^{OE}
- Deactivate cruise control.

The desired riding mode is initially preselected. The mode change does not take place until the systems in question are all in the appropriate state. The selection menu does not disappear from the display until the mode change has taken place.

DYNAMIC BRAKE CONTROL

How Dynamic Brake Control works

The Dynamic Brake Control function assists the rider in emergency braking situations.

Detection of emergency braking

- Sudden, sharp application of the front brake is interpreted as emergency braking.

Behaviour in emergency braking

- If emergency braking occurs at a speed in excess of min. 10 km/h, the ABS function is further assisted by Dynamic Brake Control.

Behaviour during accidental actuation of the throttle grip

- If the throttle is accidentally opened (throttle grip position > 5 %) during emergency

braking, Dynamic Brake Control ensures the desired braking effect by ignoring actuation of the throttle grip. The effectiveness of emergency braking is ensured.

- If the throttle is closed (throttle grip position < 5 %) while Dynamic Brake Control is in action, the engine torque requested by the ABS brake system is restored.
- If hazard braking ceases and the rider still has not changed the position of the throttle grip, Dynamic Brake Control steadily ramps engine torque back to the rider's requested level.

TYRE PRESSURE CONTROL (RDC)

- with tyre pressure control (RDC)^{OE}

Function

A sensor integrated into each tyre measures the air temperature and the air pressure inside the tyre and transmits this information to the control unit. Each sensor has a centrifugal-force tripswitch that does not enable transmission of the measured values until the motorcycle has accelerated to a

defined minimum speed for the first time.



Minimum speed for transmission of the RDC measured values:

min. 30 km/h

The display shows -- for each tyre until the tyre-pressure signal is received for the first time. The sensors continue to transmit the measured-value signals for some time after the vehicle comes to a stop.



Time for transmission of measured values after vehicle comes to a stop:

min. 15 min

An error message is issued if wheels without sensors are fitted to a vehicle equipped with an RDC control unit.

Tyre pressure ranges

The RDC control unit differentiates between three tyre-pressure ranges, all of which are parameterised for the motorcycle:

- Tyre pressure within permitted tolerance.
- Tyre pressure close to limit of permitted tolerance.
- Tyre pressure outside permitted tolerance.

146 ENGINEERING DETAILS

Temperature compensation

Tyre pressure is a temperature-sensitive variable: pressure increases as tyre-air temperature rises and decreases as tyre-air temperature drops. Tyre air temperature depends on ambient temperature as well as on the style of riding and the duration of the ride.

The tyre-pressure readings in the display are temperature-compensated and are always referenced to a tyre-air temperature of 20 °C.

The air lines available to the public in petrol stations and motorway service areas have gauges that do not compensate for temperature; the reading shown by a gauge of this nature is the temperature-dependent tyre-air pressure. As a result, the values displayed there usually do not correspond to the values displayed in the display.

Pressure adaptation

Compare the RDC value in the instrument cluster with the value in the table on the back cover of the rider's manual. Then use the air-line gauge at a service station to compensate for the difference between the

RDC reading and the value in the table.

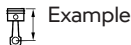

According to the operating instructions, the tyre pressure should be:

2.5 bar

The instrument cluster shows the following value:

2.3 bar

So pressure is low by:

0.2 bar

The gauge on the air line shows:

2.4 bar

You must now increase tyre pressure until the value is:

2.6 bar

GEAR SHIFT ASSISTANT

—with shift assistant Pro^{OE}

Gear Shift Assistant Pro

Your vehicle is equipped with Gear Shift Assistant Pro, a system originally developed for racing and now adapted for the touring sector. It permits upshifts and downshifts without declutching or closing the throttle in virtually all load and rpm ranges.

The engine control system supports gear changes as a function of:

- Required gear
- Engine rpm
- Position of the throttle twistgrip

The rider bears responsibility for use of the shift assistant and must take the riding situation and safety and comfort aspects duly into consideration.

Advantages

- A large proportion of gearshifts can be carried out without using the clutch.
- Less relative movement between rider and passenger because the shift pauses are shorter.
- It is not necessary to close the throttle twistgrip when shifting under acceleration.
- When downshifting (throttle twistgrip closed), engine speed is adjusted by blipping the throttle.
- Shift time is shorter than a gearshift with clutch actuation.

The rider indicates a gearshift request by moving the gearshift lever from what was an untouched position at normal to snappy speed in the appropriate direction and following this movement through to the mechanical limit position of the gearshift operation. Once the gearshift has completed the shift lever has to be fully released before another gearshift with the Pro shift assistant can take place. In order to optimise shift quality when shifting gears with the Gear Shift Assistant Pro, the rider has to keep load state (throttle twistgrip position) constant before and during the gearshift. The Gear Shift Assistant Pro provides no assistance for gearshifts when the rider declutches.

Downshifting

- Downshifting is assisted until maximum rpm for the target gear to be selected is reached. This prevents over-revving.



Maximum engine speed

max. 8500 min⁻¹

Upshifting

- Upshifting is assisted until engine speed is below idle rpm in the target gear. This prevents the engine from dropping below idle speed.
- On account of the operating principle, a certain loss of comfort and perceptibly sharper load-change reactions can be experienced if the system is used for upshifts on overrun, particularly in low gears.

HILL START CONTROL PRO (HSC PRO)

- with Hill Start Control^{OE}

Hill Start Control function

Hill Start Control Pro is a pullaway assistant that operates on the partially integral ABS system to prevent the vehicle from rolling back on a gradient, without the rider having to keep pressure applied to the brake lever. When Hill Start Control Pro is activated, pressure is built up in the rear brake system to keep the machine at a standstill on a gradient (▣ 96).

The brake pressure in the brake system is dependent on the gradient.

Effect of an incline on brake pressure and drive-off behaviour

- If the motorcycle is stopped on a gentle incline, only low brake pressure is built up. In this case, the brakes are quickly released when driving off.
- If the motorcycle is stopped on a steep incline, high brake pressure is built up. In this case, the brakes take longer to release when driving off. More torque is required for driving off which also requires the rider to turn the throttle grip again.

Behaviour when the motorcycle rolls or slips

- If the vehicle starts to roll while Hill Start Control Pro is active, brake pressure is increased.
- If the rear wheel locks up, the brake is released again after approx. 1 m. This prevents the vehicle slipping with a locked rear wheel, for example.

Brake release when engine is stopped or after time-out

Hill Start Control Pro is deactivated if the rider stops the engine by hitting the emer-

gency-off switch (kill switch) or when the side stand is extended or at the end of a ten-minute timeout.

In addition to the indicator and warning lights, the rider should be made aware that Hill Start Control Pro has been deactivated by the following behaviour:

Brake warning jolt

- The brake is released briefly and reactivated immediately.
- This creates a jolt which the rider feels.
- The partial integral ABS brake system limits the speed of movement to approx. 1...2 km/h.
- The rider must brake the motorcycle manually.
- After two minutes, or if the brake is actuated, the partially integral ABS brake system stops speed-control intervention.



The holding pressure is released immediately without a brake warning jolt as soon as the ignition is switched off.

CORNERING HEADLIGHT

-with Headlight Pro^{OE}

Function

In addition to the bulbs for low beam, high beam and, if applicable, daytime riding light or side light, the headlight has separate LED segments for the cornering light. The LED segments are activated as a function of bank angle in addition to the low-beam headlight, enabling the headlight to illuminate the inside of the bend as the motorcycle banks for cornering. The cornering headlight is optimised for slight to moderate bank angles.

The cornering headlight is activated under the following conditions:

- Cornering at a slight to moderate bank angle.
- Speed is min. 10 km/h.
- The low-beam headlight is switched on.

MAINTENANCE

09

GENERAL NOTES	152
TOOLKIT	153
PREPARING SCREWDRIVER FROM ON-BOARD TOOL-KIT	153
FRONT-WHEEL STAND	154
REAR-WHEEL STAND	154
ENGINE OIL	154
BRAKE SYSTEM	156
CLUTCH	161
TYRES	162
WHEEL RIMS	163
WHEELS	163
LIGHTING	172
JUMP-STARTING	173
BATTERY	175
FUSES	178
DIAGNOSTIC CONNECTOR	180

152 MAINTENANCE

GENERAL NOTES

The Maintenance chapter describes straightforward procedures for checking and replacing certain wear parts.

Special tightening torques are listed as applicable. The tightening torques for the threaded fasteners on your vehicle are listed in the section entitled "Technical data".

Some of the work calls for special tools and a thorough knowledge of the technology involved. If in doubt consult a specialist workshop, preferably an authorised BMW Motorrad retailer.

Microencapsulated screws

The microencapsulation is a chemical thread-locker. An adhesive compound creates a secure connection between bolt and nut or between screw and component. Consequently, microencapsulated screws are for once-only use and are not intended for re-installation after being slackened.

Regardless of whether the procedure involves removal or installation, the threaded bore always has to be cleaned. After removal of the screw, clean the

internal thread to remove all traces of thread-locking compound. Always use new microencapsulated screws when re-assembling. Prior to disassembly make sure that you have suitable tools for cleaning the threads and a new replacement for each screw to be removed. If the job is not done correctly there is no guarantee that the screw will remain secure, which means that you would be putting yourself at risk!

Non-reusable cable ties

Non-reusable cable ties are used at some points to secure cables and lines. To prevent damage to cables and lines when these items are being removed, it is essential to use a suitable tool, for example diagonal cutting pliers, for their removal.

Cables and lines detached beforehand by the removal of non-reusable cable ties have to be re-secured with new non-reusable cable ties.

Use cable-tie clippers to clip off the excess length of the cable ties.

TOOLKIT

- 1** Open-ended spanner
Width across flats 10/
14 mm
–Adjust the mirror arm.
(☛ 108)
–Adjust the spring pre-
load for front wheel.
(☛ 111)
- 2** Reversible screwdriver
blade
Plain-tip blade and
Torx T25
–Adjust the rebound-
stage damping for the
front wheel. (☛ 115)
–Adjust compression-
stage damping at front
wheel. (☛ 114)
–Adjust rebound-stage
damping for rear wheel.
(☛ 116)
- 3** Screwdriver handle
–Topping up the engine
oil. (☛ 155)
- 3** –Use with open-end
spanner
- 4** Extension for Torx
wrench
–Remove the seat.
(☛ 102)
- 5** Torx wrench, T30
–Remove the seat.
(☛ 102)
–Use with extension
- 6** Plastic cap
–Adjust the spring pre-
load for front wheel.
(☛ 111)

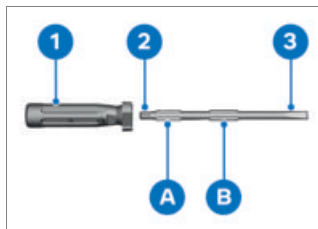
**PREPARING SCREWDRIVER
FROM ON-BOARD TOOLKIT**

- Push Torx T25 bit **2** or plain-
tip blade **3** into screwdriver
handle **1**.
- The length of plain-tip blade **3**
can be adjusted by inser-
tion in position **A** (long) or **B**
(short).

154 MAINTENANCE

FRONT-WHEEL STAND

Installing front-wheel stand



ATTENTION

Use of the front wheel stand without accompanying use of auxiliary stand

Risk of damage to parts if vehicle topples

- Place the motorcycle on an auxiliary stand before lifting the front wheel with the front-wheel stand.
- Make sure the motorcycle is standing firmly.
- Place the motorcycle on an auxiliary stand.
- Install the rear-wheel stand. (▶▶▶ 154)
- See the instructions issued with the front-wheel stand for the details of the correct procedure for installation.

REAR-WHEEL STAND

Install the rear-wheel stand

- The description of how to fit the rear-wheel stand correctly will be found in the instructions for the stand.

ENGINE OIL

Checking engine oil level



To avoid unnecessary environmental impact, BMW Motorrad recommends checking the engine oil after riding min. 50 km.



ATTENTION

Misinterpretation of oil level reading, because oil level is temperature-dependent (the higher the temperature, the higher the oil level)

Engine damage due to incorrect oil filling

- Check the oil level only after a lengthy ride or when the engine is at operating temperature.
- Switch off the engine when it is at operating temperature.
- Wait five minutes for the oil to drain into the oil pan.

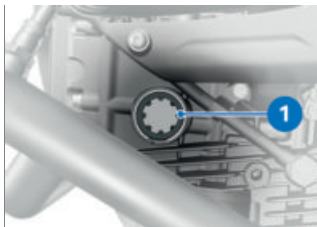
**ATTENTION****Vehicle toppling sideways**

Risk of damage to parts if vehicle topples

- Secure the vehicle, preferably with the assistance of a second person, so that it cannot topple sideways.
- Make sure the ground is level and firm and hold the motorcycle upright.
- Check the oil level in sight glass **1**.

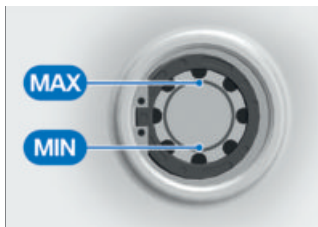

Engine oil, specified level

Between **MIN** and **MAX** marks

If the oil level is below the **MIN** mark:

- Topping up the engine oil. (→ 155)

If the oil level is above the **MAX** mark:

- Have the oil level corrected by a specialist workshop, preferably an authorised BMW Motorrad retailer.

Topping up engine oil

- Make sure the ground is level and firm and place the motorcycle on its stand.

156 MAINTENANCE

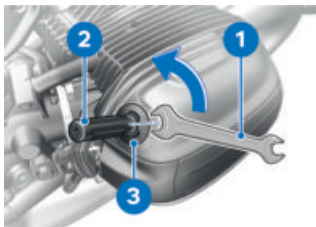

- Wipe the area around the oil filler opening clean.
- For more leverage, engage open-end spanner **1** on screwdriver handle **2** (on-board toolkit).
- Engage screwdriver handle **2** in oil filler plug **3** and turn counter-clockwise.
- Remove oil filler plug **3**.



ATTENTION

Use of insufficient engine oil or too much engine oil

Engine damage due to incorrect oil filling

- Always make sure that the engine oil level is correct.
- Top up the engine oil to the specified level.



Engine oil, quantity for topping up

max. 0.5 l (Difference between **MIN** and **MAX**)

- Check the engine oil level.
(▶▶▶ 154)

- Install oil filler plug **3**.

BRAKE SYSTEM

Check operation of the brakes

- Pull the handbrake lever.
 - » The pressure point must be clearly perceptible.
 - Press the footbrake lever.
 - » The pressure point must be clearly perceptible.
- If pressure points are not clearly perceptible:



ATTENTION

Work on brake system not in compliance with correct procedure

Risk to operational reliability of the brake system

- Have all work on the brake system undertaken by trained and qualified specialists.
 - Have the brakes checked by a specialist workshop, preferably an authorised BMW Motorrad retailer.
- #### Checking brake pad thickness, front brakes
- Make sure the ground is level and firm and place the motorcycle on its stand.

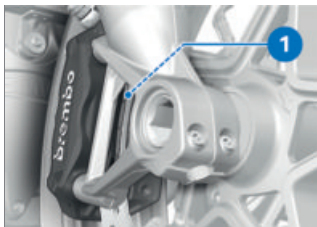

- Visually inspect the left and right brake pads to ascertain their thickness. Viewing direction: Between wheel and front suspension toward brake pads **1**.

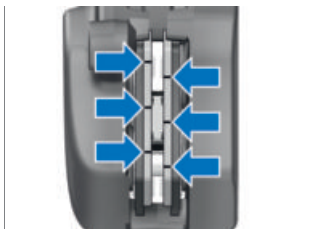

 Brake-pad wear limit, front

1.0 mm (friction pad only, without backing plate. The wear indicators (grooves) must be clearly visible.)

If the wear indicating marks are no longer visible:

WARNING

Brake-pad thickness less than permissible minimum

Diminished braking effect, damage to the brakes

- In order to ensure the dependability of the brake system, do not permit the brake pads to wear past the minimum permissible thickness.

- Have the brake pads replaced by a specialist workshop, preferably an authorised BMW Motorrad retailer.

Checking brake pad thickness, rear brakes

- Make sure the ground is level and firm and place the motorcycle on its stand.



- Visually inspect the brake pads to ascertain their thickness. Viewing direction: From the left toward the brake caliper.



Brake-pad wear limit,
rear

1.0 mm (friction pad only, without backing plate. Make sure that the brake disc is not visible through the bore in the inboard brake block.)

If the brake disc is visible:



WARNING

Brake-pad thickness less than permissible minimum

Diminished braking effect, damage to the brakes

- In order to ensure the dependability of the brake system, do not permit the brake pads to wear past the minimum permissible thickness.

- Have the brake pads replaced by a specialist workshop, preferably an authorised BMW Motorrad retailer.

Brake pad wear

The rear wheel brake has a brake-pad wear indicator.

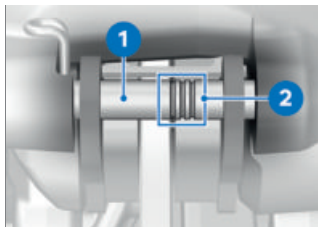

Shaft **1** with three marker rings **2** is between the brake pads.

How to interpret the marks:

- 3 rings visible: min. 75% brake pad thickness
- 2 rings visible: min. 50% brake pad thickness
- 1 ring visible: min. 25% brake pad thickness
- No ring visible: Wear limit has been reached, check as described above

Checking brake-fluid level, front brakes**WARNING****Not enough brake fluid in brake fluid reservoir, or contaminants in brake fluid**

Considerably reduced braking power due to presence of air, contaminants or water in the brake system

- Cease operation of the vehicle immediately and do not ride it until the fault has been rectified.
- Check the brake-fluid levels at regular intervals.
- Always make sure that the lid of the brake fluid reservoir and the area around the lid are cleaned before opening.
- Make sure that only fresh brake fluid from a sealed container is used.

- Make sure the ground is level and firm and place the motorcycle on its stand.



- Turn the handlebars to a position in which the brake fluid reservoir is horizontal.
- Check the brake fluid level in sight glass **1**.



Wear of the brake pads causes the brake fluid level in the reservoir to sink.



Brake fluid level, front

Brake fluid, DOT4

160 MAINTENANCE



Brake fluid level, front

It is not permissible for the brake fluid level to be below the **MIN** mark (Brake-fluid reservoir horizontal, motor-cycle upright.)

If the brake fluid level drops below the permitted level:

- Have the fault rectified as quickly as possible by a specialist workshop, preferably an authorised BMW Motorrad retailer.

Checking brake-fluid level, rear brakes



WARNING

Not enough brake fluid in brake fluid reservoir, or contaminants in brake fluid

Considerably reduced braking power due to presence of air, contaminants or water in the brake system

- Cease operation of the vehicle immediately and do not ride it until the fault has been rectified.
 - Check the brake-fluid levels at regular intervals.
 - Always make sure that the lid of the brake fluid reservoir and the area around the lid are cleaned before opening.
 - Make sure that only fresh brake fluid from a sealed container is used.
- Make sure the ground is level and firm and hold the motor-cycle upright.

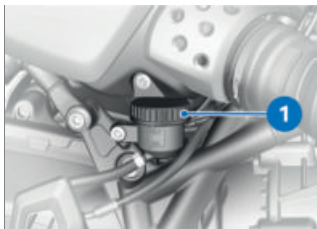

ATTENTION

Vehicle toppling sideways

Risk of damage to parts if vehicle topples

- Secure the vehicle, preferably with the assistance of a second person, so that it cannot topple sideways.
 - Check the brake fluid level in brake fluid reservoir for rear wheel brake **1**.
-  Wear of the brake pads causes the brake fluid level in the reservoir to sink.



Brake fluid level, rear

Brake fluid, DOT4

It is not permissible for the brake fluid level to be below the **MIN** mark. (Brake-fluid reservoir horizontal)

If the brake fluid level drops below the permitted level:

- Have the fault rectified as quickly as possible by a specialist workshop, preferably an authorised BMW Motorrad retailer.

CLUTCH

Checking operation of the clutch

- Pull the clutch lever.
 - » The pressure point must be clearly perceptible.

If the pressure point is not clearly perceptible:

- Have the clutch checked by a specialist workshop,

162 MAINTENANCE

preferably an authorised BMW Motorrad retailer.

TYRES

Checking tyre pressures

WARNING

Incorrect tyre pressure

Impaired handling characteristics of the motorcycle, shorter useful tyre life

- Always check that the tyre pressures are correct.

WARNING

Tendency of valve inserts installed vertically to open by themselves at high riding speeds

Sudden loss of tyre pressure

- Install valve caps fitted with rubber sealing rings and tighten firmly.
- Make sure the ground is level and firm and place the motorcycle on its stand.
- Check tyre pressures against the data below.



Tyre pressure, front

2.5 bar (tyre cold)



Tyre pressure, rear

2.7 bar (one-up, tyre cold)

2.9 bar (two-up and with luggage, tyre cold)

With incorrect tyre pressure:

- Correct tyre pressure.

Check the tyre tread depth

WARNING

Riding with badly worn tyres

Risk of accident due to impaired handling

- If applicable, have the tyres changed in good time before they wear to the minimum tread depth permitted by law.
- Make sure the ground is level and firm and place the motorcycle on its stand.
- Measure the tyre tread depth in the main tread grooves with wear marks.



Each tyre has wear indicators integrated into the main tread grooves. The tyre has reached its wear limit when the tread has worn down to the level of the wear indicators. The locations of the marks are indicated on the

edge of the tyre, e.g. by the letters TI, TWI or by an arrow.

If the tyre tread is worn to minimum:

- Replace tyre or tyres, as applicable.

WHEEL RIMS

Checking rims

- Make sure the ground is level and firm and place the motorcycle on its stand.
- Visually inspect the rims for defects.
- Have damaged rims checked and, if necessary, replaced by a specialist workshop, preferably an authorised BMW Motorrad retailer.

Check the spokes

—with Option 719 wheel Classic^{OE}

- Make sure the ground is level and firm and place the motorcycle on its stand.
- Draw the handle of a screwdriver or a similar instrument across the spokes and listen to the sequence of sounds made by the individual spokes.

If there is a variation in the sequence of sounds:

- Have the spokes checked by a specialist workshop, preferably an authorised BMW Motorrad retailer.

WHEELS

Effect of wheel size on chassis and suspension control systems

Wheel size is very important as a parameter for the suspension control systems such as ABS, for example. In particular, the diameter and the width of a vehicle's wheels are programmed into the control unit and are fundamental to all calculations. Any change in these influencing variables, caused for example by a switch to wheels other than those installed ex-works, can have serious effects on the performance of the control systems.

The sensor rings are essential for correct road-speed calculation, and they too must match the motorcycle's control systems and consequently cannot be changed.

If you decide that you would like to fit non-standard wheels to your motorcycle,

164 MAINTENANCE

it is very important to consult a specialist workshop beforehand, preferably an authorised BMW Motorrad retailer. In these cases, the data programmed into the control units has to be changed to suit the new wheel sizes.

Removing front wheel

 The front-wheel cover has to be detached on one side to facilitate removal and installation of the front wheel.

- Place the motorcycle on an auxiliary stand.
- Install the rear-wheel stand. (→ 154)
- Raise front of motorcycle until the front wheel can turn freely.
- Install the front-wheel stand. (→ 154)

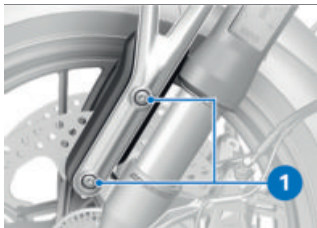

- Remove screws **1**.

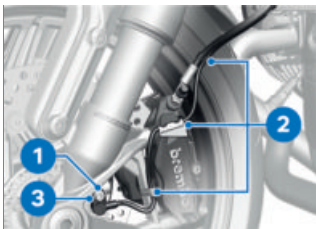

- Disengage the sensor cable from holders **2**.
- Remove screw **1** and remove wheel speed sensor **3** from its bore.



- Remove screws **1** on the left side.
- Disengage holder **2** for the sensor cable and brake caliper **3**.



- Remove screws **1** on the right side and disengage brake caliper **2**.

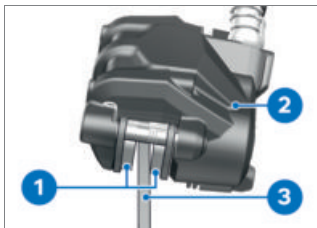

- Force brake pads **1** slightly apart by rocking brake caliper **2** back and forth against brake disc **3**.

ATTENTION

Unwanted inward movement of the brake pads

- Component damage on attempt to install the brake caliper or because brake pads have to be forced apart
- Do not operate the brakes with a brake caliper not correctly secured.

ATTENTION

Use of hard or sharp-edged objects in proximity to component

- Component damage
- Take care not to scratch components; cover or mask as necessary.

- Mask off the parts of the wheel rim that could be scratched in the process of removing the brake calipers.
- Carefully pull the brake calipers back and out until clear of the brake discs.

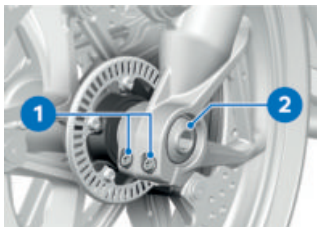

- Slacken screw **2**, but **do not remove it**.
- Slacken clamping bolts **1** on left and right.
- Press quick-release axle with screw **2** slightly toward the inside, so as to be better able to grip it on the right-hand side.
- Remove screw **2**.



- Remove spacing bushing **4** from the front wheel hub.

Installing front wheel

WARNING

Use of a non-standard wheel

Malfunctions in operation of ABS and DTC

- See the information on the effect of wheel size on the ABS and DTC systems at the start of this chapter.

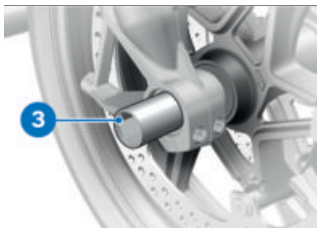

- Withdraw quick-release axle **3**, support the front wheel when doing this.
- Set down front wheel and roll forwards out of the front suspension.

ATTENTION

Tightening threaded fasteners to incorrect tightening torque

Damage, or threaded fasteners work loose

- Always have the security of the fasteners checked by a specialist workshop, preferably an authorised BMW Motorrad dealer.



- Lubricate the friction face of spacer bushing **4**.



Lubricant

Unirex N3

- Insert spacer bushing **4**, turned with the collar facing out, into the wheel hub on the left-hand side.

**ATTENTION****Front wheel installed wrong way round**

Risk of accident

- Note direction-of-rotation arrows on tyre or rim.
- Roll the front wheel into position between the forks of the front suspension.

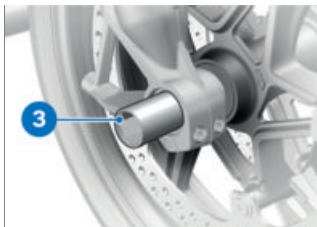

- Lubricate quick-release axle **3**.



Lubricant

Unirex N3

**WARNING****Improper installation of the quick-release axle**

Loosening of the front wheel

- After securing the brake calipers and relieving the front forks, tighten the quick-release axle and the axle clamping to the specified tightening torque.
- Lift the front wheel and insert quick-release axle **3**.
- Remove front-wheel stand and firmly compress front forks several times. Do not operate the handbrake lever in this process.
- Install the front-wheel stand. (▶▶▶ 154)

168 MAINTENANCE

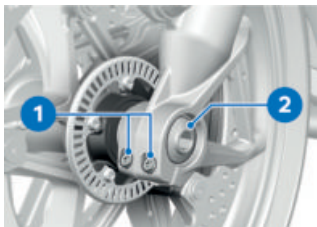

- Install screw **2**. In this process, counter-hold the quick-release axle on the right side.

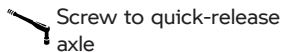

M20 x 1.5

50 Nm

- Tighten clamping bolts **1** on left and right to the specified torque.

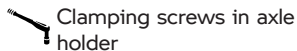
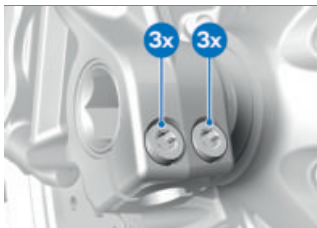

Tightening sequence: Tighten screws six times in alternate sequence

M6 x 30

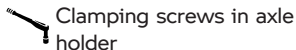

12 Nm

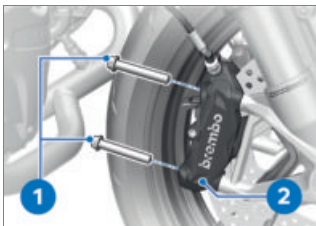

- Hold right brake caliper **2** in position and install screws **1**.

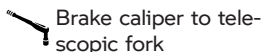

M10 x 65

38 Nm

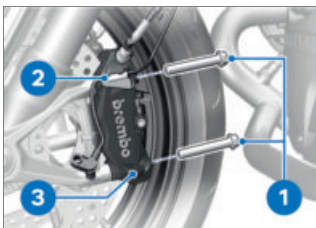

- Hold left brake caliper **3** and holder for sensor cable **2** in position.
- Install screws **1**.

170 MAINTENANCE

CAUTION

Hot exhaust system

Risk of burn injury

- Do not touch a hot exhaust system.

- Allow rear silencer to cool down.

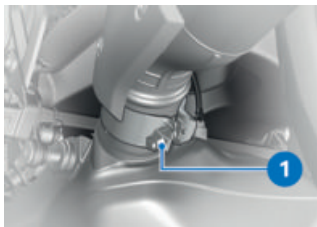

- Slacken nut **1** of the clamp and slip the clamp to the rear.

 The clamp is designed for one-time installation only and has to be replaced before the silencer is installed.



- Remove screw **1** and retaining plate **2** of the holder of

the silencer from the passenger footrest.

- Work silencer **3** to the rear to remove and lay it on a padded surface.



- Engage first gear.
- Support the wheel and remove screws **1**.
- Tilt the rear wheel to the side to remove.

Installing rear wheel

WARNING

Use of a non-standard wheel

Malfunctions in operation of ABS and DTC

- See the information on the effect of wheel size on the ABS and DTC systems at the start of this chapter.

ATTENTION

Tightening threaded fasteners to incorrect tightening torque

Damage, or threaded fasteners work loose

- Always have the security of the fasteners checked by a specialist workshop, preferably an authorised BMW Motorrad dealer.

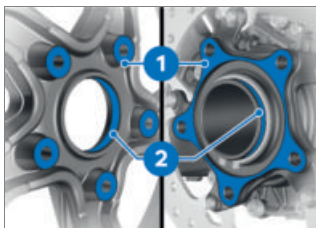

- Clean the contact surfaces of wheel hub **1** and wheel centring spigot **2**.

ATTENTION

Use of hard or sharp-edged objects in proximity to component

Component damage

- Take care not to scratch components; cover or mask as necessary.

- Seat the rear wheel on the rear-wheel adapter.

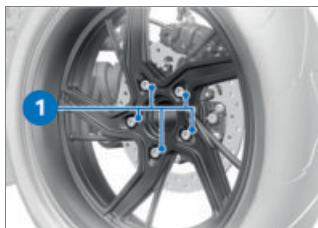

- Install bolts **1** and tighten to the specified torque.

 Rear wheel to wheel carrier

Tightening sequence: Tighten in diagonally opposite sequence

M10 x 53 x 1.25

60 Nm



- Lightly lubricate the inner face of new clamp **4**.

 Lubricant

Optimoly TA

172 MAINTENANCE

- Slide new clamp **4** on to silencer **3**.
- Slip silencer **3** on to the pipe at the exhaust flap.
- Align silencer **3**, hold retaining plate **2** in position and install screw **1**, but do not tighten the screw yet.

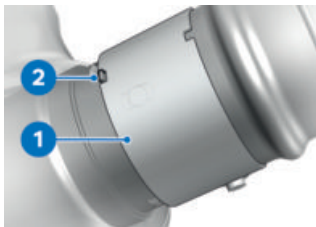

- Align the new clamp with recess **1** at retaining lug **2**.
- » Retaining lug engages recess in the clamp.



- Tighten screw **1**.

 Silencer to passenger footrest extension

M8 x 40

19 Nm

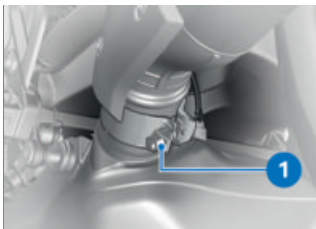

- Tighten nut **1** of the clamp.

 Clamp to silencer and exhaust manifold

Joining compound: Lubricate inner face of clamp, Optimoly TA

28 Nm

- Extend the side stand.
- Remove the rear-wheel stand.
- Place the motorcycle on its side stand.

LIGHTING

Replacing LED light sources

 **WARNING**

Vehicle overlooked in traffic due to failure of the lights on the vehicle

Safety risk

- Always replace a faulty bulb at the earliest possible opportunity. Consult a specialist workshop, preferably an authorised BMW Motorrad Retailer.

All light sources of the vehicle are LED light sources. The service life of the LED light sources is longer than the presumed vehicle service life. If an LED light source is faulty contact a specialist workshop, preferably an authorised BMW Motorrad retailer.

JUMP-STARTING



CAUTION

Touching live parts of the ignition system when the engine is running

Electric shock

- Do not touch parts of the ignition system when the engine is running.



ATTENTION

Excessive current flowing when the motorcycle is jump-started

Wiring smoulders/ignites or damage to the on-board electronics

- If the motorcycle has to be jump-started connect the leads to the battery terminals; never attempt to jump-start the engine by connecting leads to the on-board socket.



ATTENTION

Contact between crocodile clips of jump leads and vehicle

Risk of short-circuit

- Use jump leads fitted with fully insulated crocodile clips at both ends.

174 MAINTENANCE

ATTENTION

Contact between remote positive terminal and vehicle
Short-circuit hazard

- Remove the protective cap only to permit use of the remote positive terminal and re-install the protective cap after use.



- Unclip protective cap **1** from lock **2** and remove.

ATTENTION

Jump-starting with a voltage greater than 12 V

Damage to the on-board electronics

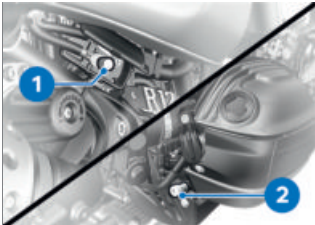
- Make sure that the battery of the donor vehicle has a voltage rating of 12 V.
 - Make sure the ground is level and firm and place the motorcycle on its stand.
 - When jump-starting the engine, do not disconnect the battery from the on-board electrical system.
- 
- Begin by connecting one end of the red jump lead to remote positive terminal **1** and the other end to the positive terminal of the donor battery.
 - Connect one end of the black jump lead to your vehicle's remote ground terminal **2** and the other end to the negative terminal of the donor battery.
 - Run the engine of the donor vehicle during jump-starting.
 - Start the engine of the vehicle with the discharged battery in the usual way; if the engine does not start, wait a

few minutes before repeating the attempt in order to protect the starter motor and the donor battery.

 Do not use proprietary start-assist sprays or other products to start the engine.

- Allow both engines to idle for a few minutes before disconnecting the jump leads.
- Disconnect the jump lead from remote ground terminal **2** first, then disconnect the second jump lead from remote positive terminal **1**.



- Insert protective cap **1** into holder **3** and clip it into lock **2**.
- » Protective cap **1** engages with an audible click.

BATTERY

Maintenance instructions

Correct upkeep, recharging and storage will prolong the life of the battery and are essential if warranty claims are to be considered.

Compliance with the points below is important in order to maximise battery life:

- Keep the surface of the battery clean and dry.
- Do not open the battery.
- Do not top up with water.
- Be sure to read and comply with the instructions for charging the battery on the following pages.
- Do not turn the battery upside down.



Battery type

AGM battery (Absorbent Glass Mat)

ATTENTION

On-board electronics (e.g. clock) draining connected battery

Battery is deep-discharged; this voids the guarantee

- Connect a float charger to the battery if the motorcycle is to remain out of use for more than four weeks.

 BMW Motorrad has developed a float charger specially designed for compatibility with the electronics of your motorcycle. Using this charger, the battery can be kept charged during long periods of disuse, without having to be disconnected from the vehicle's on-board systems. For more information, consult an authorised BMW Motorrad retailer.

Recharging battery

ATTENTION

Recharging a fully discharged battery via the power socket or extra socket

Damage to the vehicle electronics

- If a battery has discharged to the extent that it is completely flat (battery voltage less than 12 V, status-indicator lights and display remain off when the ignition is switched on) it has to be recharged with the charger connected to the remote positive terminal and the remote ground terminal of the battery.

ATTENTION

Unsuitable chargers connected to a socket

Damage to charger and vehicle electronics

- Use suitable BMW chargers. The suitable charger is available from your authorised BMW Motorrad dealer.
- Charge the battery via the power socket.

 The motorcycle's on-board electronics know when the battery is fully charged. The on-board socket is switched off when this happens.

- Comply with the operating instructions of the charger.

 If you are unable to charge the battery through the on-board socket, you may be using a charger that is not compatible with your motorcycle's electronics. In this case, charge the battery via the remote positive terminal and the remote ground terminal of the battery.

- Charge the battery via the remote positive terminal and the remote ground terminal.
- Switch off the ignition.

( 76)



ATTENTION

Contact between remote positive terminal and vehicle

Short-circuit hazard

- Remove the protective cap only to permit use of the remote positive terminal and re-install the protective cap after use.

- Unclip protective cap **1** from lock **2** and remove.

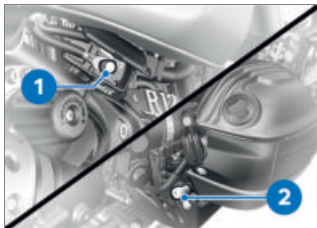

- Connect remote positive terminal **1** to the positive terminal of the charger.

178 MAINTENANCE

- Connect remote ground terminal **2** to the negative terminal of the charger.
- When charging finishes, disconnect the charger from remote ground terminal **2** first, then disconnect it from remote positive terminal **1**.



- Insert protective cap **1** into holder **3** and clip it into lock **2**.
- » Protective cap **1** engages with an audible click.

Replacing battery

If the battery is faulty consult a specialist workshop, preferably an authorised BMW Motorrad retailer.

FUSES

Replacing fuses



ATTENTION

Jumpering of blown fuses

Risk of short-circuit and fire

- Never attempt to jumper a blown fuse.
- Always replace a defective fuse with a new fuse of the same amperage.



If fuse defects recur frequently have the electric circuits checked by a specialist workshop, preferably an authorised BMW Motorrad retailer.

- Switch off the ignition.
- Make sure the ground is level and firm and place the motorcycle on its stand.
- Remove the seat. (► 102)

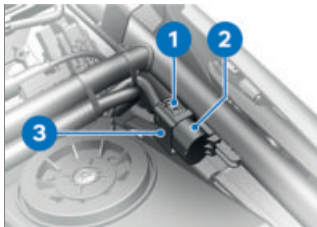

- For **fuse assignment I**, press latches **1** on both sides

and pull fuse box **3** out of holder **2**.

- Consult the fuse assignment diagram below and replace the defective fuse.
- Re-insert fuse box **3** into holder **2**. Make sure that lock **1** engages.

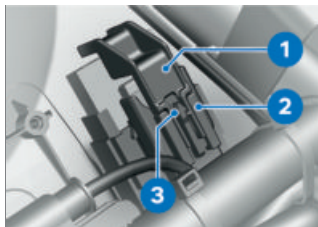

- For **fuse assignment II** use plain-tip blade from on-board toolkit to open latch **3** and lift cover **1** up to remove.
- Consult the fuse assignment diagram below and replace the defective fuse.
- Re-insert cover **1** into holder **2**.
- » Lock **3** engages.
- Install the seat. (➡ 103)

Fuse assignment I

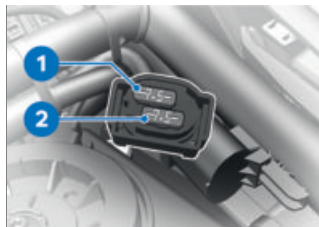

- 1** 7.5 A
Instrument cluster
Anti-theft alarm
Diagnostic socket
- 2** 7.5 A
Keyless Ride

Fuse assignment II



- 1** 60 A
Main fuse
- 2** 15 A
Multifunction switch
Instrument cluster
CCP

180 MAINTENANCE

DIAGNOSTIC CONNECTOR

Disengaging diagnostic socket



CAUTION

Incorrect disconnection of the diagnostic socket for on-board diagnosis

Malfunctions of the vehicle

- Do not disconnect the diagnostic socket or allow it to be disconnected except in the course of a BMW Motorrad service by a specialist workshop or by other authorised persons.
- Have the work carried out by appropriately trained personnel.
- Comply with the stipulations of the vehicle manufacturer.

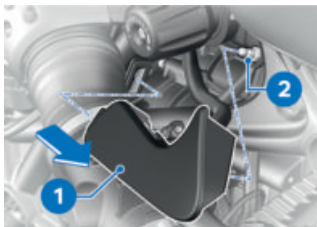

- Disengage cover **1** from holder **2** and remove it in the direction indicated by the arrow, noting the wiring of the diagnostic connector.



- Press diagnostic connector **1** lightly into holder **3** and at the same time press latches **2** on diagnostic connector **1**.
- Disengage diagnostic socket **1** from holder **3**.
 - » The interface to the diagnosis and information system can be connected to the diagnostic connector **1**.

Securing diagnostic socket

- Disconnect the interface for the diagnosis and information system.



- Insert diagnostic socket **1** into holder **3**.
 - » The locks **2** engage.

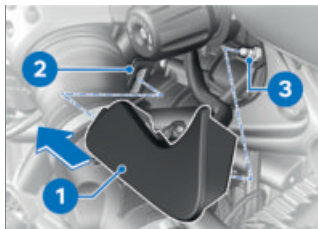

- Insert cover **1** in the direction indicated by the arrow into holder **2** and press it into holder **3**, noting the wiring of the diagnostic connector.

ACCESSORIES

10

GENERAL NOTES	184
POWER SOCKETS	184
USB CHARGING SOCKET	185
LUGGAGE	186
OPTIONAL ACCESSORIES	187

GENERAL NOTES



CAUTION

Use of other-make products

Safety risk

- BMW Motorrad cannot examine or test each product of outside origin to ensure that it can be used on or in connection with BMW vehicles without constituting a safety hazard. Country-specific official authorisation does not suffice as assurance. Tests conducted by these instances cannot make provision for all operating conditions experienced by BMW vehicles and, consequently, they are not sufficient in some circumstances.
- Use only parts and accessories approved by BMW for your vehicle.

BMW has conducted extensive testing of the parts and accessory products to establish that they are safe, functional and suitable. Consequently, BMW accepts responsibility for the products. BMW accepts no liability whatsoever for parts and accessories that it has not approved.

All modifications must be in compliance with legal requirements. Make sure that the vehicle does not infringe the national road-vehicle construction and use regulations applicable in your country. Your authorised BMW Motorrad retailer can offer expert advice on the choice of genuine BMW parts, accessories and other products. To find out more about accessories go to:

bmw-motorrad.com/equipment

POWER SOCKETS

Connection of electrical devices

- You can start using electrical devices connected to the motorcycle's sockets only when the ignition is switched on.

Cable routing

- The cables from the power sockets to the auxiliary devices must be routed in such a way that they do not impede the rider.
- The cable routing should not restrict the steering angle or obstruct handling.
- The cables must not be trapped.

Automatic shutdown

- The sockets will be automatically switched off during the start procedure.
- The power supply to the sockets is switched off 60 seconds after the ignition is switched off, in order to prevent overloading of the on-board electrics. Low-wattage electrical accessories might not be recognised by the vehicle's electronics. In such cases, power sockets are switched off very shortly after the ignition is turned off.
- If the battery charge state is too low to maintain the motorcycle's start capability, the power sockets are switched off.
- The power sockets are also switched off when the maximum load capability as stated in the technical data is exceeded.

USB CHARGING SOCKET

- with ConnectedRide Control^{OE}

Notes on use



WARNING

Obstruction of the steering angle and risk of fire due to improperly routed cables

Driving safety is impaired

- Do not wind cables around the handlebars, and ensure that the handlebars can move freely.
- When routing the cable, ensure that the cable does not come into contact with hot components.



ATTENTION

Vibrations when vehicle is moving

Damage to mobile phones carried on the vehicle

- Make sure that the mobile phone carried on the vehicle is suitable for use on the vehicle. Ask the manufacturer about related usage restrictions and comply with the information provided.

Automatic shutdown

The USB charging sockets are shut down automatically under the following circumstances:

186 ACCESSORIES

- If battery charge state is too low, to maintain the vehicle's start capability.
- If the maximum load capacity as stated in the technical data is exceeded.
- During the starting operation.

Connection of electrical devices

You can start using electrical devices connected to the USB charging sockets only when the ignition is switched on.

The power supply to the USB charging sockets is switched off 60 seconds after the ignition is switched off, in order to prevent overloading of the on-board electrics.

While riding in the rain, you should disconnect the device from the interface in order to protect against damage.

To prevent dirtying, keep the protective cover closed when no device is connected.

Cable routing

Note the following with regard to the routing of cables from USB charging sockets to items of electronic equipment:

- Make sure that cables do not impede the rider.
- Make sure that cables do not restrict the steering angle or obstruct handling.
- Make sure that cables cannot be trapped.

LUGGAGE

Securing luggage to motorcycle



WARNING

Handling adversely affected by overloading and imbalanced loads

Risk of falling

- Do not exceed the permissible gross weight and be sure to comply with the instructions on loading.
- Load. (120)
- Stow luggage in genuine BMW Motorrad accessories.
- » You can obtain additional information on luggage systems and how to secure them correctly from your authorised BMW Motorrad retailer.

Maximum payload and maximum speed

—with rear softbag^{OA}

or

—with tank bag^{OA}

or

—With side bag^{OA}

Note the maximum payload and the maximum permissible speed. Always load luggage in such a way that the motorcycle's stability against toppling over is sustained.

The values for the combination described here are as follows:

—with rear softbag^{OA}

	Payload of rear softbag
max. 10 kg	

	Capacity of the rear softbag
approx. 40 l	

	Maximum speed for riding with rear bag installed
max. 130 km/h	

—with tank bag^{OA}

	Payload of tank rucksack
≤5 kg	

	Maximum speed for riding with a loaded tank bag
---	---

≤130 km/h

—With side bag^{OA}

	Maximum load of side bag
---	--------------------------

max. 5 kg (per bag)

	Speed limit for riding with side bag
---	--------------------------------------

max. 130 km/h

OPTIONAL ACCESSORIES

Available optional accessories



Your BMW Motorrad retailer can offer expert advice on the choice of genuine BMW parts, accessories and other products such as the aluminium tail-hump cover and the cover for the rear frame, for example. You can examine all the optional accessories from

188 ACCESSORIES

BMW Motorrad by visiting:
bmw-motorrad.com.

CARE

11

CARE PRODUCTS	192
WASHING THE VEHICLE	192
CLEANING EASILY DAMAGED COMPONENTS	193
CARE OF PAINTWORK	194
PAINT PRESERVATION	195
LAYING UP MOTORCYCLE	195
RESTORING MOTORCYCLE TO USE	196

CARE PRODUCTS



ATTENTION

Use of unsuitable cleaning and care products

Damage to vehicle parts

- Do not use solvents such as cellulose thinners, cold cleaners, fuel or the like, and do not use cleaning products that contain alcohol.



ATTENTION

Use of strongly acidic or strongly alkaline cleaning agents

Damage to vehicle parts

- Dilute in accordance with the dilution ratio stated on the packaging of the cleaning agent.
- Do not use strongly acidic or strongly alkaline cleaning agents.

BMW Motorrad recommends that you use the cleaning and care products you can obtain from your authorised BMW Motorrad retailer.

BMW Motorrad The substances in Care Products have been tested in laboratories and

in practice; they provide optimised care and protection for the materials used in your vehicle.

WASHING THE VEHICLE



WARNING

Wet brake discs and brake pads after vehicle wash, after riding through water and in rainy conditions

Diminished braking effect, risk of accident

- Apply the brakes in good time to allow the friction and heat to dry the brake discs and brake pads.



ATTENTION

Damage due to high water pressure from high pressure cleaners or steam cleaners

Corrosion or short circuit, damage to labels, seals, hydraulic brake system, electrical system and the motorcycle seat

- Exercise restraint when using a steam jet or high pressure cleaning equipment.

BMW Motorrad recommends that you use BMW insect remover to soften and wash off

insects and stubborn dirt on painted parts prior to washing the vehicle.

To prevent stains, do not wash the vehicle immediately after it has been exposed to strong sunlight and do not wash it in the sun.

Remove dirt from the fork legs at regular intervals.

Make sure that the vehicle is washed frequently, especially during the winter months or if it is ridden on salted roads.



ATTENTION

Effect of road salt intensified by warm water

Corrosion

- Use only cold water to remove road salt deposits.

To remove road salt deposits, clean the vehicle and mounted parts, as applicable, with cold water immediately after every trip.



After a ride in the rain, when humidity is high or after the vehicle has been washed, condensation might form inside the headlight. This can cause temporary fogging on the headlight lens. If moisture is constantly present inside the headlight consult a spe-

cialist workshop, preferably an authorised BMW Motorrad retailer.

CLEANING EASILY DAMAGED COMPONENTS

Plastics



ATTENTION

Use of unsuitable cleaning agents

Damage to plastic surfaces

- Do not use cleaning agents that contain alcohol, solvents or abrasives.
- Do not use insect-remover pads or cleaning pads with hard, scouring surfaces.

Clean the plastic parts with water and BMW plastic care product. This includes in particular:

- Windscreen and slipstream deflectors
- Headlight lens made of plastic
- Glass cover of the instrument cluster
- Black, unpainted parts



Soften stubborn dirt and insects by covering the affected areas with a wet cloth.

194 CARE

Chrome

Carefully clean chrome parts with plenty of water and motorcycle cleaner from the BMW Care Products range. This is particularly important to counter the effects of salt. Use BMW Motorrad metal polish for additional treatment.

Radiator

ATTENTION

Bending of radiator fins

Damage to radiator fins

- Take care not to bend the radiator fins when cleaning.

Clean the radiator at regular intervals to prevent overheating of the engine due to inadequate cooling.

Use a garden hose with low water pressure, for example, for this purpose.

Rubber

ATTENTION

Application of silicone sprays to rubber seals

Damage to the rubber seals

- Do not use silicone sprays or care products that contain silicon.

Treat rubber components with water or BMW rubber-care products.

CARE OF PAINTWORK

ATTENTION

Damage to paintwork due to metal polish

Risk of damage

- Do not treat painted surfaces and chrome-painted surfaces with metal polish.

Washing the vehicle regularly will help counteract the long-term effects of substances that can damage the paint, especially if your vehicle is ridden in areas with high air pollution or natural sources of dirt, for example tree resin or pollen.

Remove particularly aggressive substances immediately, however, as otherwise the paint can be affected or become discoloured. Substances of this nature include spilt fuel, oil, grease, brake fluid and bird droppings. For this, we recommend BMW Motorrad solvent cleaner followed by BMW Motorrad gloss polish for preservation.

Marks on the paintwork are particularly easy to see after

the vehicle has been washed. Remove stains of this kind at the earliest possible opportunity, using benzine or petroleum spirit on a clean cloth or ball of cotton wool. BMW Motorrad recommends using BMW tar remover for removing specks of tar. Then apply preserving agent to the areas treated in this way.

PAINT PRESERVATION

If water no longer rolls off the paint, the paint must be preserved.

For paint preservation, BMW Motorrad recommends the use of BMW Motorrad gloss polish or agents containing carnauba wax or synthetic wax.

 Do not use chrome polish to preserve chrome paints. Use only the agents recommended by BMW Motorrad.

LAYING UP MOTORCYCLE

- Fill the motorcycle's fuel tank.

 Fuel additives clean the fuel injection system and the combustion zone. It is advisable to use fuel additives when the engine is operated with low-grade fuel or if the

vehicle is to be out of use for a lengthy period of time. More information is available from your authorised BMW Motorrad retailer.

- Clean the motorcycle.
- Spray the brake-lever and clutch-lever pivots mounts with suitable lubricant.
- Coat bright metal and chrome-plated parts with an acid-free grease (e.g. Vaseline).
- Stand the motorcycle in a dry room in such a way that there is no load on either wheel (preferably using the front-wheel and rear-wheel stands from BMW Motorrad).
- If applicable, connect the charger.

 BMW Motorrad has developed a float charger specially designed for compatibility with the electronics of your motorcycle. Using this charger, the battery can be kept charged during long periods of disuse, without having to be disconnected from the vehicle's on-board systems. For more information, consult an authorised BMW Motorrad retailer.

RESTORING MOTORCYCLE TO USE

- Remove the protective wax coating.
- Clean the motorcycle.
- Recharge the battery, if applicable.
- Note the checklist (▶▶▶ 123).

TECHNICAL DATA

12

TROUBLESHOOTING CHART	200
THREADED FASTENERS	201
FUEL, R 12 S (0N01)	203
FUEL, R 12 S A2 (0N11)	203
ENGINE OIL	204
ENGINE R 12 S (0N01)	204
ENGINE R 12 S A2 (0N11)	205
CLUTCH	205
TRANSMISSION	205
FINAL DRIVE	206
FRAME	206
CHASSIS AND SUSPENSION	206
BRAKES	208
WHEELS AND TYRES	208
ELECTRICAL SYSTEM	209
ANTI-THEFT ALARM	210
DIMENSIONS	210
WEIGHTS	211
PERFORMANCE FIGURES	211

THREADED FASTENERS

Front wheel	Value	Valid
Brake caliper to telescopic fork		
M10 x 65	38 Nm	
Clamping screws in axle holder		
M6 x 30	Tightening sequence: Tighten screws six times in alternate sequence	
	12 Nm	
Screw to quick-release axle		
M20 x 1.5	50 Nm	
Wheel-speed sensor to fork leg		
M6 x 20	8 Nm	
Rear wheel	Value	Valid
Rear wheel to wheel carrier		
M10 x 53 x 1.25	Tightening sequence: Tighten in diagonally opposite sequence	
	60 Nm	

202 TECHNICAL DATA

Mirror arm	Value	Valid
Mirror (lock nut) to adapter		
M10 x 1.25	Left-hand thread, 22 Nm	





Front-wheel cover	Value	Valid
Wheel cover, front, to forks		
M5 x 25, Replace screw micro-encapsulated	5 Nm	

Gearshift shaft	Value	Valid
Gearshift lever to selector shaft		
M6 x 25	8 Nm	



Frame	Value	Valid
Seat lock to rear frame		
M6 x 16	6 Nm	

Exhaust system	Value	Valid
Clamp to silencer and exhaust manifold		
Replace clamp Lubricate inner face of clamp, Optimoly TA	28 Nm	
Silencer to passenger footrest extension		
M8 x 40	19 Nm	

FUEL, R 12 S (0N01)

Recommended fuel grade	 Premium unleaded (maximum 15 % ethanol, E15)  95 ROZ/RON 90 AKI
Alternative fuel grade	 Regular unleaded (maximum 15 % ethanol, E15)  91 ROZ/RON 87 AKI
Usable fuel capacity	approx. 16 l
Reserve fuel	approx. 3.5 l
Fuel consumption	5.1 l/100 km, in accordance with WMTC
CO2 emission	119 g/km, in accordance with WMTC
Exhaust emissions standard	EU 5
—with Canada export ^{NV}	TIER 2, measured in accordance with FTP75

FUEL, R 12 S A2 (0N11)

Recommended fuel grade	 Regular unleaded (maximum 15 % ethanol, E15)  91 ROZ/RON 87 AKI
Usable fuel capacity	approx. 16 l
Reserve fuel	approx. 3.5 l
Fuel consumption	5.1 l/100 km, in accordance with WMTC
CO2 emission	119 g/km, in accordance with WMTC
Exhaust emissions standard	EU 5

204 TECHNICAL DATA

ENGINE OIL

Engine oil, capacity	max. 3.95 l, with filter change
Specification	SAE 15W-50, API SJ / JASO MA2, Additives (e.g. molybdenum-based) are not permissible because they can attack coated components of the engine, BMW Motorrad recommends BMW Motorrad ADVANTEC Pro oil.
Engine oil, quantity for topping up	max. 0.5 l, Difference between MIN and MAX

BMW recommends **ADVANTEC**
ORIGINAL BMW ENGINE OIL

ENGINE R 12 S (0N01)

Engine number location	Crankcase, bottom right, below starter motor
Engine type	A72B12B
Engine design	Air-/oil-cooled four-stroke opposed-twin boxer.
Displacement	1170 cm ³
Cylinder bore	101 mm
Piston stroke	73 mm
Compression ratio	12:1
Nominal capacity	80 kW, at rpm: 7000 min ⁻¹
Torque	115 Nm, at rpm: 6500 min ⁻¹
Maximum engine speed	max. 8500 min ⁻¹
Idle speed	1150 ^{±50} min ⁻¹ , Engine at regular operating temperature

ENGINE R 12 S A2 (0N11)

Engine number location	Crankcase, bottom right, below starter motor
Engine type	A72B12B
Engine design	Air-/oil-cooled four-stroke opposed-twin boxer.
Displacement	1170 cm ³
Cylinder bore	101 mm
Piston stroke	73 mm
Compression ratio	12 : 1
Nominal capacity	70 kW, at rpm: 6500 min ⁻¹
—with power reduction to 35 kW ^{OE}	35 kW, at rpm: 5250 min ⁻¹
Torque	110 Nm, at rpm: 6000 min ⁻¹
—with power reduction to 35 kW ^{OE}	98 Nm, at rpm: 3000 min ⁻¹
Maximum engine speed	max. 8500 min ⁻¹
Idle speed	1150 ^{±50} min ⁻¹ , Engine at regular operating temperature

CLUTCH

Clutch type	Single-plate dry clutch
-------------	-------------------------

TRANSMISSION

Type of transmission	Claw-shift 6-speed gearbox in separate transmission housing
----------------------	---

206 TECHNICAL DATA

Gearbox transmission ratios	1.737, Primary transmission ratio 2.375 (38:16 teeth), 1st gear 1.696 (39:23 teeth), 2nd gear 1.296 (35:27 teeth), 3rd gear 1.065 (33:31 teeth), 4th gear 0.939 (31:33 teeth), 5th gear 0.848 (28:33 teeth), 6th gear
-----------------------------	---

FINAL DRIVE

Type of final drive	Shaft drive with bevel gears
Type of rear suspension	Cast aluminium single swinging arm with BMW Motorrad Paralever
Gear ratio of final drive	2.909
Rear axle differential oil	FUCHS Titan EG 4218 SAE 70W-80

FRAME

Frame type	Tubular spaceframe
Type plate location	Frame, front left at steering head
Position of the vehicle identification number	Main frame front right at bottom

CHASSIS AND SUSPENSION

Front wheel

Type of front suspension	Upside-down telescopic fork
Spring travel, front	120 mm, at wheel

Rear wheel

Type of rear-wheel suspension	Central spring strut with coil spring, adjustable rebound stage damping and spring preload
Spring travel at rear wheel	120 mm, at wheel
Basic setting of the rear spring preload	<p>Turn all the way counter-clockwise, then back off 6 turns clockwise, with full load of fuel, with rider weighing approx. 95 kg</p> <p>Turn all the way counter-clockwise, then back off 12 turns clockwise, One-up with luggage approx. 105 kg</p> <p>Turn all the way counter-clockwise, then back off 22 turns clockwise, Two-up with luggage approx. 165 kg</p>
Basic setting of rear-suspension damping characteristic	<p>Turn the adjusting screw clockwise as far as it will go, then back it off 6 full turns, One-up riding</p> <p>Turn the adjusting screw clockwise as far as it will go, then back it off 4 turn, One-up with luggage</p> <p>Turn the adjusting screw clockwise as far as it will go, then back it off 4 turn, Two-up riding</p> <p>Turn the adjusting screw clockwise as far as it will go, then back it off 2 turn, Two-up with luggage</p>

208 TECHNICAL DATA

BRAKES

Front wheel

Type of front brake	Twin disc brakes with 4-piston fixed calipers
Brake-pad material, front	Sintered metal
Brake disc thickness, front	min. 4.0 mm, Wear limit

Rear wheel

Type of rear brake	Single-disc brake with 2-piston floating caliper
Brake-pad material, rear	Organic material
Brake disc thickness, rear	min. 4.5 mm, Wear limit

WHEELS AND TYRES

Recommended tyre combinations	Your authorised BMW Motorrad retailer will be happy to supply an up-to-date list of the approved wheel/tyre combinations.
Speed category, front/rear tyres	W, required at least: 270 km/h

Front wheel

Front-wheel type	Aluminium cast wheel
—with Option 719 wheel Classic ^{OE}	Spoked wheel
Front-wheel rim size	3.50" x 17"
Tyre designation, front	120/70 ZR 17
Load index, front tyre	min. 58
Permissible front-wheel imbalance	max. 5 g

Rear wheel	
Rear-wheel type	Aluminium cast wheel
—with Option 719 wheel Classic ^{OE}	Spoked wheel
Rear wheel rim size	5.50" x 17"
Tyre designation, rear	180/55 ZR 17
Load index, rear tyre	min. 73
Permissible rear-wheel imbalance	max. 5 g
Tyre pressures	
Tyre pressure, front	2.5 bar, tyre cold
Tyre pressure, rear	2.7 bar, One-up, tyre cold 2.9 bar, two-up and with luggage, tyre cold

ELECTRICAL SYSTEM

Fuses	
Fuse 1	60 A, Main fuse (alternator, CCP, Wave, fuse boxes)
Fuse 2	7.5 A, Anti-theft alarm system, diagnostic socket, instrument cluster
Fuse 3	7.5 A, Keyless Ride
Fuse 4	15 A, Multifunction switch, rev. counter, CCP
Battery	
Battery type	AGM battery (Absorbent Glass Mat)
Battery rated voltage	12 V
Battery rated capacity	14 Ah

210 TECHNICAL DATA

Spark plugs

Spark plugs, manufacturer and designation	NGK MAR8AI-10DS
---	-----------------

Lighting

All light sources	LED
-------------------	-----

ANTI-THEFT ALARM

Activation time on arming	1 s
Alarm duration	28 s
Battery type (For Keyless Ride radio-operated key)	CR 2032

DIMENSIONS

Length of motorcycle	2130 mm, measured over rear wheel, at DIN unladen weight
Height of motorcycle	1070 mm, without mirrors, at DIN unladen weight
Width of motorcycle	820 mm, without mounted parts 870 mm, using the hand lever
—with Option 719 Billet Pack Shadow II ^{OE}	880 mm, using the hand lever
Height of rider's seat	789...795 mm, without rider, at DIN unladen weight
Rider's inside-leg arc, heel to heel	1765 mm, without rider, at DIN unladen weight

WEIGHTS

Vehicle kerb weight	220 kg, DIN unladen weight, ready for road, 90 % load of fuel, without optional extras (OE)
Permissible gross vehicle weight	430 kg
Maximum payload	210 kg

PERFORMANCE FIGURES

Top speed	>200 km/h
-----------	-----------

SERVICE

13

REPORTING SAFETY-RELEVANT DEFECTS	214
RECYCLING	215
BMW MOTORRAD SERVICE	215
BMW MOTORRAD SERVICE HISTORY	216
BMW MOTORRAD MOBILITY SERVICES	217
MAINTENANCE WORK	217
MAINTENANCE SCHEDULE	219
BMW MOTORRAD RUNNING-IN CHECK	221
MAINTENANCE CONFIRMATIONS	222

REPORTING SAFETY-RELEVANT DEFECTS

—with Canada export^{NV}

If you believe that your vehicle has a defect which could cause a crash or could cause injury or death, you should immediately inform the NHTSA (National Highway Traffic Safety Administration) in addition to notifying the BMW of North America, LLC.

If the NHTSA receives other, similar complaints, it may open an investigation. If it finds that a safety defect exists in a group of vehicles, the NHTSA it may order a recall and remedy campaign. However, the NHTSA cannot become involved in individual problems between you, your retailer, or BMW of North America, LLC. You can contact the NHTSA by calling the Vehicle Safety Hotline on 1-888-327-4236 (teletypewriter TTY for the hearing impaired: 1-800-424-9153) toll-free, by visiting the website at <http://www.safercar.gov> or by writing to Administrator, NHTSA, 400 Seventh Street, SW., Washington, DC 20590. Further information on vehicle safety is available at <http://www.safercar.gov>.

Canadian customers who wish to report a safety-related defect to Transport Canada, Defect Investigations and Recalls can call the toll-free hotline 1-800-333-0510. You can obtain further information about motor vehicle safety from <http://www.tc.gc.ca/roadsafety>.

RECYCLING

Disposal of an EOL vehicle

BMW Motorrad recommends disposing of a vehicle that has reached the end of its useful life by taking it to a manufacturer-designated receiving centre for EOL vehicles.

In general, the laws of the country in question apply for receiving and recycling of EOL vehicles. Information about recycling and sustainability can be viewed on the country-specific websites of the manufacturer. Additional information can be obtained on request from your authorised BMW Motorrad retailer or another qualified service partner, or from a specialist workshop.

Disposal of the rider's manual

—with France export^{NV}



Dispose of this rider's manual by depositing it in the container provided for the purpose.

BMW MOTORRAD SERVICE

BMW Motorrad has an extensive network of retailers in place to look after you and your motorcycle in more than 100 countries. Authorised BMW Motorrad retailers have the technical information and the technical know-how to carry out reliably all preventive maintenance and repair work on your BMW.

You can locate the nearest authorised BMW Motorrad retailer by visiting our website:

bmw-motorrad.com



WARNING

Maintenance and repair work not in compliance with correct procedure

Risk of accident due to consequential damage

- BMW Motorrad recommends having work of this nature carried out on the vehicle by a specialist workshop, preferably an authorised BMW Motorrad dealer.

In order to help ensure that your BMW is always in optimum condition, BMW Motorrad recommends compliance with the maintenance intervals specified for your motorcycle.

Have all maintenance and repair work carried out confirmed in the "Service" chapter in this manual. Evidence of regular preventive maintenance is essential for generous treatment of claims submitted after the warranty period has expired.

You can inquire about the content of BMW Motorrad services at your authorised BMW Motorrad retailer.

BMW MOTORRAD SERVICE HISTORY

Entries

Maintenance work that has been carried out is entered in the proof of maintenance. The entries are like a Service Booklet and provide proof of regular maintenance.

When an entry is made in the electronic service booklet of the vehicle, service-relevant data is saved in the central IT systems accessible through BMW.

If there is a change in vehicle ownership, the data saved in the electronic service booklet can also be viewed by the new vehicle owner. An authorised BMW Motorrad retailer or a specialist workshop can also view data that is stored in the electronic service booklet.

Objection

The vehicle owner can object to entries being made by the authorised BMW Motorrad retailer or a specialist workshop in the electronic service

booklet along with the corresponding storage of data in the vehicle and transfer of data to the vehicle manufacturer for the period of time that they are the vehicle owner. In this instance, no entry is made in the electronic service booklet of the vehicle.

BMW MOTORRAD MOBILITY SERVICES

As the owner of a new BMW, in the event of a breakdown you can benefit from the protection afforded by the various BMW Motorrad mobility services (e.g. BMW Mobile Service, breakdown service, vehicle recovery service). Your authorised BMW Motorrad retailer will be happy to provide information about the mobility services available to you.

MAINTENANCE WORK

BMW pre-delivery check

The BMW pre-delivery check is performed by your authorised BMW Motorrad retailer before the vehicle is handed over to you.

BMW Running-in check

The BMW running-in check has to be performed when the vehicle has covered between 500 km and 1200 km.

BMW Motorrad Service

The BMW Motorrad Service is carried out once a year; the extent of servicing can vary, depending on the age of the vehicle and the distance it has covered. Your authorised BMW Motorrad retailer confirms that the service work has been carried out and enters the date when the next service will be due.

Riders who cover long distances in a year might have to bring in their vehicles for service before the next scheduled date. It is to allow for these cases that a maximum odometer reading is entered as well in the confirmation of service. Servicing has to be brought forward if this odometer reading is reached before the next scheduled date for the service.

218 SERVICE

The service-due indicator in the display reminds you about one month or 1000 km in advance when the time for a service is approaching.

To find out more about service go to:

bmw-motorrad.com/service

The maintenance tasks necessary for your vehicle are set out in the maintenance schedule below. The tasks listed are due either when the vehicle has covered the stated distances, or periodically at the stated times.

MAINTENANCE SCHEDULE

	500 -1200 km 300 - 750 mls	10 000 km 6 000 mls	20 000 km 12 000 mls	30 000 km 18 000 mls	40 000 km 24 000 mls	50 000 km 30 000 mls	60 000 km 36 000 mls	70 000 km 42 000 mls	80 000 km 48 000 mls	90 000 km 54 000 mls	100 000 km 60 000 mls	12 months	24 months
1	X												
2		X	X	X	X	X	X	X	X	X	X	X ^a	
3		X	X	X	X	X	X	X	X	X	X	X ^a	
4			X		X		X		X		X		X ^b
5		X	X	X	X	X	X	X	X	X	X		
6					X				X			X ^c	X ^c
7			X		X		X		X		X		
8			X		X		X		X		X		
9					X ^d				X ^d				
10				X			X			X			
11				X ^f			X ^f			X ^f			
12									X ^f				
13												X ^e	X ^e

- 1 BMW Motorrad running-in check (including oil change and oil filter change)
- 2 BMW Motorrad Service, standard scope
- 3 Engine-oil change, with filter
- 4 Oil change in bevel gears rear
- 5 Check valve clearances
- 6 Change transmission oil
- 7 Replace all spark plugs
- 8 Replace air-filter element
- 9 Replace belt for alternator
- 10 Oil change in the telescopic forks
- 11 Cardan shaft, visual inspection and lubrication
- 12 Replace Cardan shaft
- 13 Change brake fluid, entire system
 - a annually or every 10000 km (whichever comes first)
 - b every two years or every 20000 km (whichever comes first)

220 SERVICE

- c for the first time after one year, then every two years or 40000 km (whichever comes first)
- d every six years or every 40000 km (whichever comes first)
- e for the first time after one year, then every two years
- f referenced to the distance over which the component was in use

BMW MOTORRAD RUNNING-IN CHECK

BMW Motorrad running-in check

The tasks included in the BMW Motorrad running-in check are listed below. The actual scope of work applicable for your vehicle may vary.

- Setting service-due date and countdown distance
- Performing vehicle test with BMW Motorrad diagnostic system
- Engine-oil change, with filter
- Changing oil in bevel gears
- Check the brake-fluid level, front wheel brake
- Check the brake-fluid level, rear wheel brake
- Checking tyre tread depth and tyre pressures
- Check the tension of the spokes, adjust if necessary
- Checking lighting and signalling system
- Function test, engine start suppression
- Final inspection and check of roadworthiness
- Performing vehicle test with BMW Motorrad diagnostic system
- Confirm the BMW service in the on-board literature

MAINTENANCE CONFIRMATIONS

BMW Motorrad Service standard scope

The tasks included in the BMW Motorrad Service standard scope are listed below. The actual scope of maintenance work applicable for your vehicle may vary.

- Performing vehicle test with BMW Motorrad diagnostic system
- Visual inspection of clutch system
- Checking steering-head bearing
- Visual inspection of the brake lines, brake hoses and connections
- Check the front brake pads and brake discs for wear
- Check the brake-fluid level, front wheel brake
- Check the rear brake pads and brake disc for wear
- Check the brake-fluid level, rear wheel brake
- Check the tyre pressures and tread depth
- Check the side stand's ease of movement
- Check the tension of the spokes, adjust if necessary
- Draining condensate from intake silencer
- Checking lighting and signalling system
- Function test, engine start suppression
- Final inspection and check of roadworthiness
- Performing vehicle test with BMW Motorrad diagnostic system
- Setting service-due date and countdown distance with BMW Motorrad diagnostic system
- Checking battery state of charge
- Confirm the BMW Motorrad service in the on-board literature

BMW Motorrad pre-delivery check

carried out

on _____

Stamp, signature

BMW Motorrad running-in check

carried out

on _____

odometer reading _____

Next service

at the latest

on _____

or, when reached earlier

odometer reading _____

Stamp, signature

224 SERVICE

BMW Motorrad service

carried out

on _____

odometer reading _____

Next service

at the latest

on _____

or, when reached earlier

odometer reading _____

Work performed

	Yes	No
BMW Motorrad service	<input type="checkbox"/>	<input type="checkbox"/>
Engine oil change with filter	<input type="checkbox"/>	<input type="checkbox"/>
Oil change in rear angular gearbox	<input type="checkbox"/>	<input type="checkbox"/>
Checking valve clearance	<input type="checkbox"/>	<input type="checkbox"/>
Change gearbox oil	<input type="checkbox"/>	<input type="checkbox"/>
Renewing all spark plugs	<input type="checkbox"/>	<input type="checkbox"/>
Replacing the air filter element	<input type="checkbox"/>	<input type="checkbox"/>
Replacing belt for generator	<input type="checkbox"/>	<input type="checkbox"/>
Changing the oil in the telescopic fork	<input type="checkbox"/>	<input type="checkbox"/>
Visual inspection and lubricate Cardan shaft (during service)	<input type="checkbox"/>	<input type="checkbox"/>
Replacing Cardan shaft (during service)	<input type="checkbox"/>	<input type="checkbox"/>
Changing the front brake fluid	<input type="checkbox"/>	<input type="checkbox"/>
Replace rear brake fluid	<input type="checkbox"/>	<input type="checkbox"/>

Notes

Stamp, signature

BMW Motorrad service

carried out

on _____

odometer reading _____

Next service

at the latest

on _____

or, when reached earlier

odometer reading _____

Work performed

	Yes	No
BMW Motorrad service	<input type="checkbox"/>	<input type="checkbox"/>
Engine oil change with filter	<input type="checkbox"/>	<input type="checkbox"/>
Oil change in rear angular gearbox	<input type="checkbox"/>	<input type="checkbox"/>
Checking valve clearance	<input type="checkbox"/>	<input type="checkbox"/>
Change gearbox oil	<input type="checkbox"/>	<input type="checkbox"/>
Renewing all spark plugs	<input type="checkbox"/>	<input type="checkbox"/>
Replacing the air filter element	<input type="checkbox"/>	<input type="checkbox"/>
Replacing belt for generator	<input type="checkbox"/>	<input type="checkbox"/>
Changing the oil in the telescopic fork	<input type="checkbox"/>	<input type="checkbox"/>
Visual inspection and lubricate Cardan shaft (during service)	<input type="checkbox"/>	<input type="checkbox"/>
Replacing Cardan shaft (during service)	<input type="checkbox"/>	<input type="checkbox"/>
Changing the front brake fluid	<input type="checkbox"/>	<input type="checkbox"/>
Replace rear brake fluid	<input type="checkbox"/>	<input type="checkbox"/>

Notes

Stamp, signature

226 SERVICE

BMW Motorrad service

carried out

on _____

odometer reading _____

Next service

at the latest

on _____

or, when reached earlier

odometer reading _____

Work performed

	Yes	No
BMW Motorrad service	<input type="checkbox"/>	<input type="checkbox"/>
Engine oil change with filter	<input type="checkbox"/>	<input type="checkbox"/>
Oil change in rear angular gearbox	<input type="checkbox"/>	<input type="checkbox"/>
Checking valve clearance	<input type="checkbox"/>	<input type="checkbox"/>
Change gearbox oil	<input type="checkbox"/>	<input type="checkbox"/>
Renewing all spark plugs	<input type="checkbox"/>	<input type="checkbox"/>
Replacing the air filter element	<input type="checkbox"/>	<input type="checkbox"/>
Replacing belt for generator	<input type="checkbox"/>	<input type="checkbox"/>
Changing the oil in the telescopic fork	<input type="checkbox"/>	<input type="checkbox"/>
Visual inspection and lubricate Cardan shaft (during service)	<input type="checkbox"/>	<input type="checkbox"/>
Replacing Cardan shaft (during service)	<input type="checkbox"/>	<input type="checkbox"/>
Changing the front brake fluid	<input type="checkbox"/>	<input type="checkbox"/>
Replace rear brake fluid	<input type="checkbox"/>	<input type="checkbox"/>

Notes

Stamp, signature

BMW Motorrad service

carried out

on _____

odometer reading _____

Next service

at the latest

on _____

or, when reached earlier

odometer reading _____

Work performed

	Yes	No
BMW Motorrad service	<input type="checkbox"/>	<input type="checkbox"/>
Engine oil change with filter	<input type="checkbox"/>	<input type="checkbox"/>
Oil change in rear angular gearbox	<input type="checkbox"/>	<input type="checkbox"/>
Checking valve clearance	<input type="checkbox"/>	<input type="checkbox"/>
Change gearbox oil	<input type="checkbox"/>	<input type="checkbox"/>
Renewing all spark plugs	<input type="checkbox"/>	<input type="checkbox"/>
Replacing the air filter element	<input type="checkbox"/>	<input type="checkbox"/>
Replacing belt for generator	<input type="checkbox"/>	<input type="checkbox"/>
Changing the oil in the telescopic fork	<input type="checkbox"/>	<input type="checkbox"/>
Visual inspection and lubricate Cardan shaft (during service)	<input type="checkbox"/>	<input type="checkbox"/>
Replacing Cardan shaft (during service)	<input type="checkbox"/>	<input type="checkbox"/>
Changing the front brake fluid	<input type="checkbox"/>	<input type="checkbox"/>
Replace rear brake fluid	<input type="checkbox"/>	<input type="checkbox"/>

Notes

Stamp, signature

BMW Motorrad service

carried out

on _____

odometer reading _____

Next service

at the latest

on _____

or, when reached earlier

odometer reading _____

Work performed

	Yes	No
BMW Motorrad service	<input type="checkbox"/>	<input type="checkbox"/>
Engine oil change with filter	<input type="checkbox"/>	<input type="checkbox"/>
Oil change in rear angular gearbox	<input type="checkbox"/>	<input type="checkbox"/>
Checking valve clearance	<input type="checkbox"/>	<input type="checkbox"/>
Change gearbox oil	<input type="checkbox"/>	<input type="checkbox"/>
Renewing all spark plugs	<input type="checkbox"/>	<input type="checkbox"/>
Replacing the air filter element	<input type="checkbox"/>	<input type="checkbox"/>
Replacing belt for generator	<input type="checkbox"/>	<input type="checkbox"/>
Changing the oil in the telescopic fork	<input type="checkbox"/>	<input type="checkbox"/>
Visual inspection and lubricate Cardan shaft (during service)	<input type="checkbox"/>	<input type="checkbox"/>
Replacing Cardan shaft (during service)	<input type="checkbox"/>	<input type="checkbox"/>
Changing the front brake fluid	<input type="checkbox"/>	<input type="checkbox"/>
Replace rear brake fluid	<input type="checkbox"/>	<input type="checkbox"/>

Notes

Stamp, signature

BMW Motorrad service

carried out

on _____

odometer reading _____

Next service

at the latest

on _____

or, when reached earlier

odometer reading _____

Work performed

	Yes	No
BMW Motorrad service	<input type="checkbox"/>	<input type="checkbox"/>
Engine oil change with filter	<input type="checkbox"/>	<input type="checkbox"/>
Oil change in rear angular gearbox	<input type="checkbox"/>	<input type="checkbox"/>
Checking valve clearance	<input type="checkbox"/>	<input type="checkbox"/>
Change gearbox oil	<input type="checkbox"/>	<input type="checkbox"/>
Renewing all spark plugs	<input type="checkbox"/>	<input type="checkbox"/>
Replacing the air filter element	<input type="checkbox"/>	<input type="checkbox"/>
Replacing belt for generator	<input type="checkbox"/>	<input type="checkbox"/>
Changing the oil in the telescopic fork	<input type="checkbox"/>	<input type="checkbox"/>
Visual inspection and lubricate Cardan shaft (during service)	<input type="checkbox"/>	<input type="checkbox"/>
Replacing Cardan shaft (during service)	<input type="checkbox"/>	<input type="checkbox"/>
Changing the front brake fluid	<input type="checkbox"/>	<input type="checkbox"/>
Replace rear brake fluid	<input type="checkbox"/>	<input type="checkbox"/>

Notes

Stamp, signature

230 SERVICE

BMW Motorrad service

carried out

on _____

odometer reading _____

Next service

at the latest

on _____

or, when reached earlier

odometer reading _____

Work performed

	Yes	No
BMW Motorrad service	<input type="checkbox"/>	<input type="checkbox"/>
Engine oil change with filter	<input type="checkbox"/>	<input type="checkbox"/>
Oil change in rear angular gearbox	<input type="checkbox"/>	<input type="checkbox"/>
Checking valve clearance	<input type="checkbox"/>	<input type="checkbox"/>
Change gearbox oil	<input type="checkbox"/>	<input type="checkbox"/>
Renewing all spark plugs	<input type="checkbox"/>	<input type="checkbox"/>
Replacing the air filter element	<input type="checkbox"/>	<input type="checkbox"/>
Replacing belt for generator	<input type="checkbox"/>	<input type="checkbox"/>
Changing the oil in the telescopic fork	<input type="checkbox"/>	<input type="checkbox"/>
Visual inspection and lubricate Cardan shaft (during service)	<input type="checkbox"/>	<input type="checkbox"/>
Replacing Cardan shaft (during service)	<input type="checkbox"/>	<input type="checkbox"/>
Changing the front brake fluid	<input type="checkbox"/>	<input type="checkbox"/>
Replace rear brake fluid	<input type="checkbox"/>	<input type="checkbox"/>

Notes

Stamp, signature

BMW Motorrad service

carried out

on _____

odometer reading _____

Next service

at the latest

on _____

or, when reached earlier

odometer reading _____

Work performed

	Yes	No
BMW Motorrad service	<input type="checkbox"/>	<input type="checkbox"/>
Engine oil change with filter	<input type="checkbox"/>	<input type="checkbox"/>
Oil change in rear angular gearbox	<input type="checkbox"/>	<input type="checkbox"/>
Checking valve clearance	<input type="checkbox"/>	<input type="checkbox"/>
Change gearbox oil	<input type="checkbox"/>	<input type="checkbox"/>
Renewing all spark plugs	<input type="checkbox"/>	<input type="checkbox"/>
Replacing the air filter element	<input type="checkbox"/>	<input type="checkbox"/>
Replacing belt for generator	<input type="checkbox"/>	<input type="checkbox"/>
Changing the oil in the telescopic fork	<input type="checkbox"/>	<input type="checkbox"/>
Visual inspection and lubricate Cardan shaft (during service)	<input type="checkbox"/>	<input type="checkbox"/>
Replacing Cardan shaft (during service)	<input type="checkbox"/>	<input type="checkbox"/>
Changing the front brake fluid	<input type="checkbox"/>	<input type="checkbox"/>
Replace rear brake fluid	<input type="checkbox"/>	<input type="checkbox"/>

Notes

Stamp, signature

232 SERVICE

BMW Motorrad service

carried out

on _____

odometer reading _____

Next service

at the latest

on _____

or, when reached earlier

odometer reading _____

Work performed

	Yes	No
BMW Motorrad service	<input type="checkbox"/>	<input type="checkbox"/>
Engine oil change with filter	<input type="checkbox"/>	<input type="checkbox"/>
Oil change in rear angular gearbox	<input type="checkbox"/>	<input type="checkbox"/>
Checking valve clearance	<input type="checkbox"/>	<input type="checkbox"/>
Change gearbox oil	<input type="checkbox"/>	<input type="checkbox"/>
Renewing all spark plugs	<input type="checkbox"/>	<input type="checkbox"/>
Replacing the air filter element	<input type="checkbox"/>	<input type="checkbox"/>
Replacing belt for generator	<input type="checkbox"/>	<input type="checkbox"/>
Changing the oil in the telescopic fork	<input type="checkbox"/>	<input type="checkbox"/>
Visual inspection and lubricate Cardan shaft (during service)	<input type="checkbox"/>	<input type="checkbox"/>
Replacing Cardan shaft (during service)	<input type="checkbox"/>	<input type="checkbox"/>
Changing the front brake fluid	<input type="checkbox"/>	<input type="checkbox"/>
Replace rear brake fluid	<input type="checkbox"/>	<input type="checkbox"/>

Notes

Stamp, signature

BMW Motorrad service

carried out

on _____

odometer reading _____

Next service

at the latest

on _____

or, when reached earlier

odometer reading _____

Work performed

	Yes	No
BMW Motorrad service	<input type="checkbox"/>	<input type="checkbox"/>
Engine oil change with filter	<input type="checkbox"/>	<input type="checkbox"/>
Oil change in rear angular gearbox	<input type="checkbox"/>	<input type="checkbox"/>
Checking valve clearance	<input type="checkbox"/>	<input type="checkbox"/>
Change gearbox oil	<input type="checkbox"/>	<input type="checkbox"/>
Renewing all spark plugs	<input type="checkbox"/>	<input type="checkbox"/>
Replacing the air filter element	<input type="checkbox"/>	<input type="checkbox"/>
Replacing belt for generator	<input type="checkbox"/>	<input type="checkbox"/>
Changing the oil in the telescopic fork	<input type="checkbox"/>	<input type="checkbox"/>
Visual inspection and lubricate Cardan shaft (during service)	<input type="checkbox"/>	<input type="checkbox"/>
Replacing Cardan shaft (during service)	<input type="checkbox"/>	<input type="checkbox"/>
Changing the front brake fluid	<input type="checkbox"/>	<input type="checkbox"/>
Replace rear brake fluid	<input type="checkbox"/>	<input type="checkbox"/>

Notes

Stamp, signature

DECLARATION OF CONFORMITY	235
BATTERY DIRECTIVE	238
RADIO EQUIPMENT TFT INSTRUMENT CLUSTER	240
KEYLESS RIDE SYSTEM MAIN UNIT	243
KEYLESS RIDE SYSTEM ACTIVE KEY	246
RADIO EQUIPMENT INTELLIGENT EMERGENCY CALL	249
RADIO EQUIPMENT TYRE PRESSURE CONTROL (RDC)	250

DECLARATION OF CONFORMITY

Manufacturer

Bayerische Motoren Werke Aktiengesellschaft
Petuelring 130, 80809 Munich, Germany

Simplified EU Declaration of Conformity according to EU RED (2014/53/EU).



Simplified UK Declaration of Conformity according to Radio Equipment Regulations 2017 of the United Kingdom.



Hereby, BMW AG declares that the radio equipment components listed below are in compliance with Directive 2014/53/EU and with Radio Equipment Regulations 2017 of the United Kingdom. The full text of the EU/UK declarations of conformity are available at the following internet address: **bmw-motorrad.com/certification**

Technical information

Radio equipment	Component	Frequency band	Output/Transmission Power
EWS4	EWS	134 kHz	50 dB μ V/m
HUF5794	Keyless Ride	433.92 MHz	10 mW
HUF8485	Keyless Ride	134.45 kHz	42 dB μ V/m
ZB001	Keyless Ride	134.5 kHz	allowed 66 dB μ A/ m @ 10m

236 APPENDIX

Radio equipment	Component	Frequency band	Output/Transmission Power
ZB002	Keyless Ride	433.92 MHz	max. 10 dBm e.r.p
TXBM-WMR	DWA 8	433.05 MHz - 434.79 MHz	18.8 dBm
RDC3	RDC	433.92 MHz	< 13 mW
Wus Moto gen 3	RDC	433.05 MHz - 434.79 MHz	< 10 mW e.r.p.
MC24-MA4	RDC		
WCA Motor- rad-Lade- staufach	Charging compartment	110 kHz - 115 kHz	< 6 W
ICC6.5in	Instrument Cluster	Bluetooth: 2402 MHz - 2480 MHz WLAN: 2412 MHz - 2462 MHz	Bluetooth: < 4 dBm WLAN: < 20 dBm
ICC65V2	Instrument Cluster	Bluetooth: 2400 MHz - 2480 MHz WLAN: 2400 MHz - 2480 MHz	Bluetooth: < 10 mW WLAN: < 100 mW
ICC10in	Instrument Cluster	Bluetooth: 2402 MHz - 2480 MHz WLAN: 2402 MHz - 2472 MHz	Bluetooth: < 4 dBm WLAN: < 14 dBm
MR- Re14FCR	ACC	76 - 77 GHz	Peak max. 32 dBm Nom max. 27 dBm

Radio equipment	Component	Frequency band	Output/Transmission Power
ARS513	Front radar	77 GHz	Peak max. 30 dBm
SRR521	Rear radar	77 GHz	Peak max. 30 dBm
TL1P22	Intelligent emergency call	832 MHz - 862 MHz 880 MHz - 915 MHz 1710 MHz - 1785 MHz 1920 MHz - 1980 MHz 2500 MHz - 2570 MHz 2570 MHz - 2620 MHz GNSS: 1559 MHz - 1610 MHz	23 dBm 33 dBm 30 dBm 24 dBm 23 dBm 23 dBm
TL1M-23NE	Intelligent emergency call	703 MHz - 748 MHz 832 MHz - 862 MHz 880 MHz - 915 MHz 1710 MHz - 1785 MHz 1920 MHz - 1980 MHz 2300 MHz - 2400 MHz 2500 MHz - 2570 MHz 2570 MHz - 2620 MHz GNSS: 1559 MHz - 1610 MHz	23 dBm 23 dBm 33 dBm 30 dBm 24 dBm 23 dBm 23 dBm 23 dBm
MCR001	Audio system		
ZB005	Keyless Ride Main Unit	134.5 kHz 433.92 MHz	< 66 dB μ A/m
ZB006	Keyless Ride Active Key	134.5 kHz 433.92 MHz	< 10 mW e.r.p.
LIN2BTLE Gateway	Instrument Cluster	2400 MHz - 2483.5 MHz	< 3 dBm

238 APPENDIX

BATTERY DIRECTIVE

Batteries are generally subject to the battery directive 2023/1542/EU. Consumer information on the batteries can be found in the relevant sections of this manual.

Batteries are integrated in the following components:

Technical information

Component	Type	Contact
RDC sensor	17109	LID TECHNOLOGIES, 3 rue Giotto, 31520 Ramonville, Saint Agne, France E-mail: contact@lid.tech www.lid.tech
KLR Key	HUF5794	Huf Hülsbeck & Fürst GmbH & Co. KG, Steeger Str.17, 42551 Velbert, Germany E-mail: info@huf-group.com www.huf-group.com
KLR Key	ZB002	ZADI S.p.A., Via Carlo Marx 138, 41012 Carpi (MO), Italy E-mail: info@zadi.com www.zadi.com
KLR Key	ZB006	ZADI S.p.A., Via Carlo Marx, 138 41012 Carpi (MO), Italy E-mail: info@zadi.com www.zadi.com
DWA8 ECU	DWA8	Meta System S.p.A, Via Tancredi Galimberti 5, 42124 Reggio Emilia, Italy www.metasystemcorporation.com
DWA8 RC	TXBMWMR	Meta System S.p.A, Via Tancredi Galimberti 5, 42124 Reggio Emilia, Italy www.metasystemcorporation.com

Component	Type	Contact
DWA9	DWA9	Bury Sp. z o.o., ul. Wojska Polskiego 4, 39-300 Mielec, Poland E-mail: info@bury.com www.bury.com

240 APPENDIX

RADIO EQUIPMENT TFT INSTRUMENT CLUSTER

For all Countries without EU

Model name: LIN2BTLE

Gateway

Manufacturer

Bury Sp. z o.o.

ul. Wojska Polskiego 4, 39-300

Mielec, Poland

Technical Information

BTLE: 2400 MHz - 2483,5 MHz

Output power: < - 3 dBm

Country

Algeria



Agréé par L'ANF: 117/H/ANF/2023

Approved by ANF/Homologué par l'ANF /Approval Number: No.117/H/ANF/2023

Canada

IC: 5927A-LIN2BTLE

This device complies with Part 15 of the FCC Rules and with RSS-247 and RSS-Gen of the Industry Canada Rules. Operation is subject to the following two conditions:

(1) this device may not cause interference, and

(2) this device must accept any interference received, including interference that may cause undesired operation.

Le présent appareil est conforme aux CNR d'Industrie Canada applicables aux appareils radio exempts de licence. L'exploitation est autorisée aux deux conditions suivantes :

(1) l'appareil ne doit pas produire de brouillage, et

(2) l'utilisateur de l'appareil doit accepter tout brouillage radioélectrique subi, même si le brouillage est susceptible d'en compromettre le fonctionnement.

NOTICE

Changes or modifications made to this equipment not expressly approved by Bury Sp. z o. o.may void the FCC authorization to operate this equipment

NOTE

This equipment has been tested and found to comply with the limits for a Class B digital device, pursuant to Part 15 of the FCC Rules. These limits are designed to provide reasonable protection against harmful interference in a residential installation. This equipment ge-

nerates, uses and can radiate radio frequency energy and, if not installed and used in accordance with the instructions, may cause harmful interference to radio communications. However, there is no guarantee that interference will not occur in a particular installation. If this equipment does cause harmful interference to radio or television reception, which can be determined by turning the equipment off and on, the user is encouraged to try to correct the interference by one or more of the following measures:

- Reorient or relocate the receiving antenna.
- Increase the separation between the equipment and receiver.
- Connect the equipment into an outlet on a circuit different from that to which the receiver is connected.
- Consult the dealer or an experienced radio/TV technician for help.

Malaysia



HIDF15000195

Mexico



IFT: BMBMLI23-19214

Uso del espectro radioeléctrico

"La operación de este equipo está sujeta a las siguientes dos condiciones:

- (1) es posible que este equipo o dispositivo no cause interferencia perjudicial y
- (2) este equipo o dispositivo debe aceptar cualquier interferencia, incluyendo la que pueda causar su operación no deseada"

242 APPENDIX

Morocco

AGREE PAR L'ANRT MAROC

Numéro d'agrément:

MR_00036504_ANRT_2023

Date d'agrément: 2023-01-27

Nigeria

Connection and use of this communications equipment is permitted by the Nigerian Communications Commission

Pakistan



TAC NO. 9.142/2023

Paraguay



NR: 2023-03-I-0217

Serbia



И 005 23

Singapore

Complies with

IMDA Standards

DA103787

South Africa



Taiwan

CCAH23LP2420T1

Warning:

低功率射頻器材技術規範警語 取得審驗證明之低功率射頻器材，非經核准，公司、商號或使用者均不得擅自變更頻率、加大功率或變更原設計之特性及功能。低功率射頻器材之使用不得影響飛航安全及干擾合法通信；經發現有干擾現象時，應立即停用，並改善至無干擾時方得繼續使用。前述合法通信，指依電信管理法規定作業之無線電通信。低功率射頻器材須忍受合法通信或工業、科學及醫療用電波輻射性電機設備之干擾。

KEYLESS RIDE SYSTEM MAIN UNIT

For all countries without EU

Model name: ZB005

Manufacturer

ZADI S.p.A.

Via Carlo Marx 138, 41012 Carpi
(MO), Italy

Technical Information

Nominal voltage:

13,5 V

Operating voltage:

6,7 - 16 V

Operating temperature:

-20 °C - +60 °C

Operating frequency LF:

134,5 kHz

Operating frequency HF:

433,92 MHz

RF power:

< 66 dB μ A/m

IP grade:

IP5K6K

Country

Argentina



H-28764

Australia/New Zealand



R-NZ

Brunei



Ref. Num.: DTA-022593

Canada

IC: 22239-KLRMZB005

This device complies with Industry Canada licence-exempt RSS standard(s). Operation is subject to the following two conditions:

- (1) this device may not cause interference, and
- (2) this device must accept any interference, including interference that may cause undesired operation of the device.

This Class B digital device complies with Canadian ICES-003. Le présent appareil est conforme aux CNR d'Industrie Canada applicables aux appareils radio exempts de licence. L'exploitation

244 APPENDIX

est autorisée aux deux conditions suivantes :

(1) l'appareil ne doit pas produire de brouillage, et

(2) l'appareil doit accepter tout brouillage radioélectrique subi, même si le brouillage est susceptible d'en compromettre le fonctionnement.

Cet appareil numérique classe B est conforme à la norme Canadien NMB-003.

Hong Kong

Certified for use in Hong Kong
Certification No. HK0012202803

India

ZB005 Registration Number:
ETA-SD-20221109924

Indonesia



73343/SDPPI/2021
13349

Israel

שם בעל ההיתר : ZADI S.P.A ITALY

מס : Italy דגם : ZB005AGREE PAR L'ANRT MAROC

אשר אישור מס : 5172747 .Numéro d'agrément:

מאשר MHz 433.05 -434.79 הMR00035262ANRT2022

Date d'agrément: 14/11/2022

השידור אינו עולה

Jordan

BMW Keyless Ride System is in conformity with Jordanian technical requirements.

Malaysia



RFDT/45A/1222/S(22-5677)

Mexico

Advertencias de IFETEL

La operación de este equipo está sujeta a las siguientes dos condiciones:

(1) es posible que este equipo o dispositivo no cause interferencia perjudicial y;

(2) este equipo o dispositivo debe aceptar cualquier interferencia, incluyendo la que pueda causar su operación no deseada.

ZB005 Certificado Homologacion Numero:

BMBMZB22-28194

Morocco

Nigeria

The equipment has been found to comply with the standards of the Commission and therefore approved for connection to the Nigerian Telecommunication Network, or for use in Nigeria.

Pakistan



Approved by PTA
TAC NO: 9.110/2021

Paraguay



NR: 2023-01-I-0035

Philippines



Type Approved
No.: ESD-RCE-2231813

Serbia



RI 005 22

Singapore

Complies with
IMDA Standards
DA105282

Sultanate of Oman

TRA/TA-R/14769/22
D100428

South Africa



TA-2022/3277

Taiwan



取得審驗證明之低功率射頻器材，非經核准，公司、商號或使用者均不得擅自變更頻率、加大功率或變更原設計之特性及功能。低功率射頻器材之使用

246 APPENDIX

不得影響飛航安全及干擾合法通信；經發現有干擾現象時，應立即停用，並改善至無干擾時方得繼續使用。前述合法通信，指依電信管理法規定作業之無線電通信。低功率射頻器材須忍受合法通信或工業、科學及醫療用電波輻射性電機設備之干擾

Vietnam



KEYLESS RIDE SYSTEM ACTIVE KEY

For all countries without EU

Model name: ZB006

Manufacturer

ZADI S.p.A.

Via Carlo Marx 138, 41012 Carpi
(MO), Italy

Technical Information

Battery type

CR2032

Nominal voltage:

3 V

Operating voltage:

2,5 - 3,16 V

Operating temperature:

-20 °C - +60 °C

Operating frequency LF:

134,5 kHz

Operating frequency HF:

433,92 MHz

RF power:

< 10 mW e.r.p.

IP grade:

IP5K7

Country

Argentina



H-28765

Australia/New Zealand



R-NZ

Brunei



Ref. Num.: DTA-022594

Canada

IC: 22239-KLRKZB006

This device complies with Industry Canada licence-exempt RSS standard(s). Operation is subject to the following two conditions:

- (1) this device may not cause interference, and
- (2) this device must accept any interference, including interference that may cause undesired operation of the device.

This Class B digital device complies with Canadian ICES-003.

Le présent appareil est conforme aux CNR d'Industrie Canada applicables aux appareils radio exempts de licence. L'exploitation est autorisée aux deux conditions suivantes :

- (1) l'appareil ne doit pas produire de brouillage, et
- (2) l'appareil doit accepter tout brouillage radioélectrique subi, même si le brouillage est susceptible d'en compromettre le fonctionnement.

Cet appareil numérique classe B est conforme à la norme Canadien NMB-003.

Hong Kong

Certified for use in Hong Kong Certification No. HK0012202804

India

ZB005 Registration Number:
ETA-SD-20221109929

Indonesia



73333/SDPPI/2021
13349

Israel

שם בעל ההיתר: ZADI S.P.A ITALY
דגם: Italy; ארץ: ZB006
מס. 5172748 אסור להחליף את
האנטנה מאושר לתחום תדרים MHz
433.05-434.79 אשר ספק השידור
אינו עולה MW.10

Jordan

BMW Keyless Ride System is in conformity with Jordanian technical requirements.

Malaysia



RFDT/44A/1222/S(22-5676)

248 APPENDIX

Mexico

Advertencias de IFETEL

La operación de este equipo está sujeta a las siguientes dos condiciones:

(1) es posible que este equipo o dispositivo no cause interferencia perjudicial y;

(2) este equipo o dispositivo debe aceptar cualquier interferencia, incluyendo la que pueda causar su operación no deseada.

ZB006 Certificado Homologación Numero:

BMBMZB22-28198

Morocco

AGREE PAR L'ANRT MAROC

Numéro d'agrément:

MR00035261ANRT2022

Date d'agrément: 14/11/2022

Nigeria

The equipment has been found to comply with the standards of the Commission and therefore approved for connection to the Nigerian Telecommunication Network, or for use in Nigeria.

Oman

TRA/TA-R/14770/22

D100428

Pakistan



Approved by PTA
TAC NO: 9.111/2021

Paraguay



NR: 2023-01-I-0036

Philippines



Type Approved
No.: ESD-RCE-2231812

Serbia



И 005 22

Singapore

Complies with
IMDA Standards
DA105282

South Africa

TA-2022/2861

Taiwan

取得審驗證明之低功率射頻器材，非經核准，公司、商號或使用者均不得擅自變更頻率、加大功率或變更原設計之特性及功能。低功率射頻器材之使用不得影響飛航安全及干擾合法通信；經發現有干擾現象時，應立即停用，並改善至無干擾時方得繼續使用。前述合法通信，指依電信管理法規規定作業之無線電通信。低功率射頻器材須忍受合法通信或工業、科學及醫療用電波輻射性電機設備之干擾

Vietnam**RADIO EQUIPMENT INTELLIGENT EMERGENCY CALL**

For all countries without EU

Model name: TL1M23NE

Manufacturer

LG ELECTRONICS INC.
10, Magokjungang 10-ro,
Gangseo-gu Seoul, Republic of
Korea

Country**Canada**

IC: US0186.2022.000413

This equipment complies with IC radiation exposure limits set forth for an uncontrolled environment. This equipment should be installed and operated with minimum distance 3.5 cm between the radiator & your body. Operation is subject to the following two conditions:

- (1) this device may not cause interference, and
- (2) this device must accept any interference, including interfe-

250 APPENDIX

rence that may cause undesired operation of the device.

The manufacturer is not responsible for any radio or tv interference caused by unauthorized modifications to this equipment. Such modifications could void the user's authority to operate the equipment.

Avis d'Industrie Canada sur l'exposition aux rayonnements
Cet appareil est conforme aux limites d'exposition aux rayonnements d'Industrie Canada pour un environnement non contrôlé. Il doit être installé de façon à garder une distance minimale de 3.5 centimètres entre la source de rayonnements et votre corps. L'exploitation est autorisée aux deux conditions suivantes :

(1) l'appareil ne doit pas produire de brouillage, et

(2) l'appareil doit accepter tout brouillage radioélectrique subi, même si le brouillage est susceptible d'en compromettre le fonctionnement.

Le fabricant n'est pas responsable des interférences radioélectriques causées par des modifications non autorisées apportées à cet appareil. de telles modifications pourrait annuler l'autori-

sation accordée à l'utilisateur de faire fonctionner l'appareil.

RADIO EQUIPMENT TYRE PRESSURE CONTROL (RDC)

For all countries without EU

Model name:

Wus moto gen 3

Manufacturer

LDL Technology S.A.S.

Parc Technologique du Canal,
3 rue Giotto, 31520 Ramonville,
France

Technical information

Frequency band: 433,92 MHz

Maximum effective radiated power: 16,75 dBm

Country

Argentina

CNC COMISIÓN NACIONAL DE COMUNICACIONES

H-23422

Australia



Malaysia

RBEF/29A/0919/S(19-3776)

MexicoIFETEL: IFT/223/UCS/DG-AUSE/
2418/2019**Morocco**

AGREE PAR L'ANRT MAROC

Numéro d'agrément :

MR 20577 ANRT 2019

Date d'agrément :

26/07/2019

Singapore

Complies with

IMDA Standards

N3305-19

South Africa

TA-2019/1178

APPROVED

Taiwan

第十二條 經型式認證合格之低功率射頻電機，非經許可，公司、商號或使用者均不得擅自變更頻率、加大功率或變更原設計之特性及功能。第十四條 低功率射頻電機之使用不得影響飛航安全及干擾合法通信；經發現有干擾現象時，應立即停用，並改善至無干擾時方得繼續使用。前項合法通信，指依電信法規定作業之無線電通信。低功率射頻電機須忍受合法通信或工業、科學及醫療用電波輻射性電機設備之干擾。

252 INDEX

- 1**
 - 12 V battery
 - Warning indicators, 51
- A**
 - Abbreviations and symbols, 4
 - ABS
 - Engineering details, 136
 - Warning indicators, 40, 42, 43
 - Accessories
 - general notes, 184
 - Active cruise control
 - Warning light, 50
 - Ambient temperature, 40
 - Anti-theft alarm
 - activating, 87
 - adjusting, 89
 - deactivating, 89
 - Indicator light, 24, 25
 - operating, 87
 - Average consumption
 - showing, 68
 - Average speed
 - showing, 68
 - Average values
 - resetting, 66
- B**
 - Battery
 - Maintenance instructions, 175
 - Position on the vehicle, 20
 - Recharging battery, 176
 - Replacing battery, 178
 - Technical data, 209
 - Warning indicators, 50, 51
 - Brake fluid
 - Checking fluid level,
 - front, 159
 - Checking fluid level, rear, 160
 - Reservoir, front, 19
 - Reservoir, rear, 19
 - Brake pads
 - checking front, 156
 - checking rear, 157
 - Running in, 125
 - Brakes
 - ABS Pro, 139
 - ABS Pro depending on riding mode, 128
 - Adjusting handbrake lever, 110
 - Checking operation, 156
 - Dynamic Brake Control
 - depending on riding mode, 128
 - Safety information, 126
 - Technical data, 208
 - Wear indicator, 158
- C**
 - Care
 - Chrome, 194
 - Paintwork preservation, 195
 - Washing the vehicle, 192
 - Central locking
 - Control, 23
 - Chassis and suspension
 - Technical data, 206
 - Checklist, 123
 - Clock
 - adjusting, 69
 - Display: CLOCK, 62, 64

- Clutch
 - Adjusting clutch lever, 109
 - Checking operation, 161
 - Fluid reservoir, 18
 - Technical data, 205

- Controls, 60

- Coolant temperature
 - Display: ENG TMP, 62, 64

- Cornering headlight
 - Engineering details, 149

- Cruise control
 - operating, 93

- Current consumption
 - showing, 68

D

- Damping
 - adjusting, 114

- Date
 - adjusting, 69
 - showing, 68

- Daytime riding lights
 - automatic daytime riding light, 85

- Diagnostic connector
 - disengaging, 180
 - securing, 180

- Dimensions
 - Technical data, 210

- Display, 24, 25
 - Adjusting display brightness, 69
 - Exit SETUP, 67
 - Overview, 29
 - SETUP, 67

DTC

- Engineering details, 139
 - operating, 90
 - switching off, 90
 - switching on, 91
- Warning indicators, 40, 41, 42

DWA

- Warning indicators, 45
- Dynamic Brake Control, 144
 - Engineering details, 144
- Dynamic engine brake control, 141

E

- Electrical system
 - Technical data, 209
- Emergency call
 - Automatically in the event of a light fall, 82
 - Automatically in the event of a severe fall, 83
 - Control, 23
 - Language, 80
 - Notes, 12
 - Warning indicators, 49
- Emergency off switch (kill switch), 22, 23
 - operating, 79
- Engine
 - starting, 123
 - Technical data, 204, 205
 - Warning indicator lights, 48
 - Warning indicators, 47

254 INDEX

- Engine oil
 - Checking fill level, 154
 - Filler neck, 19
 - Fill-level indicator, 18
 - Technical data, 204
 - topping up, 155
- Engine temperature
 - Indicator light for overheating, 52
- EWS
 - Electronic immobiliser, 41
- F**
- Final drive
 - Technical data, 206
- Footrests
 - Position on the vehicle, 18
- Frame
 - Technical data, 206
- Front-wheel stand
 - installing, 154
- Fuel
 - Filler neck, 18
 - Fuel reserve, 55
 - Refuelling, 130
 - Technical data, 203
- Fuel reserve
 - Display distance: KM R, 62, 64
 - Indicator light, 54
- Fuses
 - replacing, 178
 - Technical data, 209
- G**
- General views
 - Displays, 29
 - Indicator and warning lights, 28, 30
- Instrument cluster, 24, 25, 31, 32
 - Left multifunction switch, 21
 - left side of vehicle, 18
 - Right handlebar fitting, 22, 23
 - right side of vehicle, 19
 - Underneath the seat, 20
- H**
- Hazard warning flashers
 - Control, 21
 - operating, 83
- Headlight
 - Adjustment for right-hand/left-hand traffic, 109
 - Headlight beam throw, 109
- Headlight courtesy delay feature, 83
- Heated handlebar grips, 98
 - operating, 98
- Hill Start Control, 96, 148
- Hill Start Control Pro
 - adjusting, 96
 - Engineering details, 148
 - operating, 97
- Horn, 21
- I**
- Ignition
 - Control, 23
 - Switching off ignition, 76
 - Switching on ignition, 76
- Immobiliser
 - EWS indicator light, 41
 - Spare key, 78
- Indicator lights, 24, 25
 - Overview, 28, 30

- Instrument cluster
 - Ambient-light brightness sensor, 24, 25
 - Configuring displays, 68
 - Overview, 24, 25
- Instrument panel
 - operating, 58
 - Overview, 31, 32

J

- Jump-starting, 173

K

- Keyless Ride
 - Battery of the radio-operated key is empty or loss of the radio-operated key, 76
 - Warning indicators, 44
- Keys, 75

L

- Lighting
 - Replacing LED light sources, 172
 - Technical data, 210
 - Warning indicators, 46, 47
- Lights

- automatic daytime riding light, 85
- Control, 21
- Cornering headlight, 149
- Headlight courtesy delay feature, 83
- Headlight flasher, operating, 83
- High-beam headlight, operating, 83
- Low-beam headlight, 83

- Operating auxiliary head-lights, 84
- Parking lights, operating, 84
- Side light, 83

- Luggage
 - lashing, 186

M

- Maintenance
 - Maintenance schedule, 219
- Maintenance confirma-tions, 222
- Maintenance intervals, 217
- Mirrors
 - adjusting, 108
- Mobility services, 217
- Motorcycle
 - care, 190
 - cleaning, 190
 - lashing, 132
 - laying up, 195
 - parking, 129
 - restoring to use, 196
- Multifunction switch
 - Overview, left side, 21
 - Overview, right side, 22, 23

O

- Odometer
 - Display: KM, 62, 64
- On-board voltage, 51
 - showing, 68

P

- Parking, 129
- Passenger seat
 - Lock, 19
- Payload table
 - Sign, 20

256 INDEX

Performance figures

Technical data, 211

Phone

connect, 100

Power socket

Notes on use, 184

Position on the vehicle, 18

Pre-Ride-Check, 124

Pure Ride

Overview, 31, 32

R

Radio-operated key

Warning indicators, 44

RDC

Engineering details, 145

Warning indicators, 52, 53,

54

Rear-wheel stand

installing, 154

Recycling, 215

Refuelling, 130

Remote control

Replacing battery, 77

Rev. counter, 24

Riding mode, 91

Engineering details, 142

Running in, 125

S

Safety instructions

for brakes, 126

for riding, 120

Screw connections, 201

Seat

installing, 102

removing, 102

Service, 215

Reporting safety-relevant

defects, 214

Service history, 216

Warning indicators, 45, 46

Service-due indicator, 55

Settings

Display: SETUP ENTER, 62,

64

SETUP

ending, 67

resetting, 68

selecting, 67

Shift assistant

Engineering details, 146

Riding, 125

Smartphone holder

operating, 100

Spark plugs

Technical data, 210

Speedometer, 24, 29

Spring preload

Adjuster, rear, 19

adjusting, 111

Starting, 123

Control, 22, 23

Steering lock

Locking the steering lock, 74

Unlocking steering lock, 74

T

Technical data

Battery, 209

Brakes, 208

Chassis and suspension, 206

Clutch, 205

Dimensions, 210

Electrical system, 209

Engine, 204, 205

- Engine oil, 204
- Final drive, 206
- Frame, 206
- Fuel, 203
- Fuses, 209
- Lighting, 210
- Performance figures, 211
- Spark plugs, 210
- Transmission, 205
- Weights, 211
- Wheels and tyres, 208
- Toolkit
 - Position on the vehicle, 20
- Torques, 201
- Traction control, 139
 - DTC, 139
- Transmission
 - Technical data, 205
- Tripmeter
 - Display: KM 1 or KM A, 62, 64
 - resetting, 66
- Troubleshooting chart, 200
- Turn indicators
 - Control, 21
 - operating, 83
- Type plate
 - Position on the vehicle, 18
- Tyre pressures
 - Sign, 18
- Tyres
 - Checking tread depth, 162
 - Checking tyre pressure, 162
 - Pressures, 209
 - Running in, 125
 - Technical data, 208
 - Top speed, 121
- U**
 - USB charging socket
 - Position on the vehicle, 18
- V**
 - Vehicle identification number
 - Position on the vehicle, 19
- W**
 - Warning indicator lights, 50
 - 12V battery, 51
 - ABS, 40, 42, 43
 - Anti-theft alarm, 45
 - Bulb faulty, 46
 - Cruise control, 50
 - DTC, 40, 41, 42
 - Electrical machine control unit, 47
 - Electrical machine temperature, 52
 - Electronic immobiliser EWS, 41
 - Emergency call, 49
 - Engine, 48
 - EWS, 41
 - Fuel reserve, 54
 - Keyless Ride, 44
 - Light control failed, 47
 - Mode of presentation, 33
 - On-board voltage, 51
 - Outside temperature warning, 40
 - Overview, 28
 - Service, 45, 46
 - Side stand, 49
 - TPM, 52, 53, 54
 - Warning light, drive malfunction, 48

258 INDEX

- Warning light, drive malfunction, 48
- Warning lights, 24, 25
- Warnings, overview, 35
- Weights
 - Technical data, 211
- Wheels
 - Change of size, 163
 - Check the spokes, 163
 - Checking rims, 163
 - Installing front wheel, 166
 - Installing rear wheel, 170
 - Removing front wheel, 164
 - Removing rear wheel, 169
 - Technical data, 208

Details described or illustrated in this booklet may differ from the vehicle's actual specification as purchased, the accessories fitted or the national-market specification. No claims will be entertained as a result of such discrepancies.

Dimensions, weights, fuel consumption and performance data are quoted to the customary tolerances.

The right to modify designs, equipment and accessories is reserved.

Errors and omissions excepted.



© 2024 Bayerische Motoren
Werke Aktiengesellschaft
80788 Munich, Germany

Not to be reproduced by any means whatsoever, wholly or in part, without the written permission of BMW Motorrad, After-sales.

Original rider's manual, printed in Germany.

Important data for refuelling:

Fuel

Recommended fuel grade	 Premium unleaded (maximum 15 % ethanol, E15)  95 ROZ/RON 90 AKI
------------------------	--

Recommended fuel grade	R 12 S A2 (0N11): see chapter Technical data.
------------------------	---

Usable fuel capacity	approx. 16 l
----------------------	--------------

Reserve fuel	approx. 3.5 l
--------------	---------------

Tyre pressures

Tyre pressure, front	2.5 bar, tyre cold
----------------------	--------------------

Tyre pressure, rear	2.7 bar, One-up, tyre cold 2.9 bar, two-up and with luggage, tyre cold
---------------------	--

For further information on all aspects of your vehicle, visit: [bmw-motorrad.com](https://www.bmw-motorrad.com)

