



BMW Motorrad

Rider's Manual (US Model)

R 1250 R

Motorcycle/Retailer Data

Motorcycle Data

Model

Vehicle identification number

Color number

Initial registration

License plate

Retailer Data

Contact in Service

Ms./Mr.

Phone number

Retailer's address/phone number (company stamp)

Welcome to BMW

Congratulations on choosing a motorcycle from BMW Motorrad and welcome to the community of BMW motorcycle owners and riders. Familiarize yourself with your new motorcycle so that you can ride it safely and confidently in all highway traffic situations.

About this Rider's Manual

Please read this Rider's Manual carefully before starting to use your new BMW. It contains important information on how to operate the controls and how to get the most benefit from your BMW's advanced technical features.

In addition, it contains information on maintenance and care to help you maintain your motorcycle's reliability and safety, as well as its value.

Documentation confirming performance of scheduled maintenance is a precondition for generous handling of out-of-warranty claims and goodwill warranty treatment.

Should you want to sell your BMW one day, please also remember to turn over the Ride's Manual to the new owner. It is an important part of your motorcycle.

Suggestions and complaints

If you have any questions concerning your motorcycle, your authorized BMW Motorrad retailer is always happy to provide advice and assistance.

We wish you many miles of safe and enjoyable riding on your BMW

BMW Motorrad.

01 40 9 446 727



Table of Contents

1 General instructions	5	3 Displays	23	Electronic chassis and suspension adjustment (D-ESA)	70
Overview	6	Indicator and warning lights	24	Riding mode	73
Abbreviations and symbols	6	TFT display in Pure Ride view	25	PRO riding mode	75
Equipment	7	TFT display in the View menu	27	Cruise-control system	76
Technical Data	7	Warning lights	28	Hill Start Control (Hill Start Control)	79
Notice concerning current status	8	4 Operation.....	57	Shiftpoint light.....	81
Additional sources of information.....	8	Steering and ignition lock	58	Anti-theft alarm system (DWA).....	82
Certificates and operating permits	8	Ignition with Keyless Ride	60	Tire Pressure Monitor (TPM)	84
Data memory.....	8	Emergency on/off switch (kill switch)	64	Heated handlebar grips	84
2 Overviews	13	Lights	64	Rider and passenger seats	85
General view, left side	15	Hazard warning flashers	66	5 TFT display	87
General view, right side	17	Turn indicators	66	General notes	88
Underneath the seat	18	Antilock Braking System (ABS).....	67	Principle.....	89
Multifunction switch, left	19	Traction control (ASC/DTC)	69	Pure Ride view	96
Multifunction switch, right	21			General settings.....	97
Instrument cluster	22			Bluetooth.....	98
				My vehicle	102
				Sport	105

Navigation	107	Brakes	133	9 Maintenance	157
Media	109	Parking your motorcycle.....	134	General notes	158
Phone	109	Refueling	135	On-board tool kit	158
Display software version	110	Securing motorcycle for transportation	139	Service tool set	158
Display license information.....	110	8 Technology in detail.....	141	Front wheel stand.....	159
6 Setting.....	111	General notes	142	Rear-wheel stand	160
Mirrors	112	Antilock Braking System (ABS).....	142	Engine oil	161
Headlight	113	Traction control (ASC/DTC)	145	Brake system	162
Clutch	114	Dynamic ESA	147	Clutch	167
Gearshift lever.....	115	Riding mode	148	Coolant.....	167
Brakes	116	Dynamic Brake Control....	149	Tires	168
Footrests.....	118	Tire pressure control (TPC/RDC)	150	Wheel rims and tires	168
Spring preload	119	Shift assistant	152	Wheels	169
Damping	120	Hill Start Control (Hill Start Control)	153	Muffler	176
7 Riding.....	123	ShiftCam	155	Air filter.....	177
Safety information.....	124	10 Accessories	191	Light sources	179
Observe checklist	126	General notes	192	Jump-starting	181
Before every journey:.....	127	Onboard power sockets.....	192	Battery	182
At every third refueling stop	127	Case	193	Fuses	186
Starting.....	127			Data link connector	188
Breaking in	131				
Shifting gears	131				

Topcase.....	195	Wheels and tires	223	14 Appendix.....	253
Navigation system.....	198	Electrical system	225	Certificate for Electronic	
11 Care	205	Anti-theft alarm system ...	226	Immobilizer	254
Care products	206	Dimensions	227	Certificate for Key-	
Washing your motorcy-		Weights	228	less Ride	256
cle.....	206	Performance data	228	Certificate for Tire Pressure	
Cleaning sensitive motorcy-		13 Service	229	Control	258
cle parts.....	207	Reporting safety		Certificate for TFT instru-	
Paint care	208	defects	230	ment cluster.....	259
Protective wax coating	208	BMW Motorrad Service ...	231	15 Index	262
Store motorcycle.....	208	BMW Motorrad Service			
Return motorcycle to		History	231		
use.....	209	BMW Motorrad Mobility			
12 Technical data	211	Services.....	232		
Troubleshooting chart.....	212	Maintenance proce-			
Threaded fasteners	215	dures.....	232		
Fuel	218	BMW Service	232		
Engine oil	219	Maintenance schedule	235		
Engine	219	Maintenance confirma-			
Clutch	220	tions.....	236		
Transmission.....	220	Service confirmations	250		
Rear-wheel drive	221				
Frame	221				
Suspension	222				
Brakes	223				

General instructions

Overview	6
Abbreviations and symbols	6
Equipment	7
Technical Data	7
Notice concerning current status	8
Additional sources of information	8
Certificates and operating permits ...	8
Data memory	8

Overview

This Rider's Manual has been designed to provide quick and efficient orientation. The quickest way for you to find information on specific topics is to consult the comprehensive index at the back of the manual. If you would like to start with a quick overview of your motorcycle, this information has been provided in chapter 2. All maintenance and repair work carried out on your motorcycle will be documented in Chapter 12. Documentation confirming performance of scheduled maintenance is a precondition for generous handling of out-of-warranty claims and goodwill warranty treatment.

When the time comes to sell your BMW, remember to hand over this Rider's Manual; it is an important part of the motorcycle.

Abbreviations and symbols



CAUTION Hazard with low risk. Failure to avoid this hazard can result in minor or moderate injury.



WARNING Hazard with moderate risk. Failure to avoid this hazard can result in death or serious injury.



DANGER Hazard with high risk. Failure to avoid this hazard results in death or serious injury.



ATTENTION Special instructions and precautionary measures. Non-compliance can cause damage to the vehicle or accessories and warranty claims may be denied as a result.



NOTICE Special information on operating and inspecting your motorcycle as well

as maintenance and adjustment procedures.



Indicates the end of an item of information.



Instruction.



Result of an activity.



Reference to a page with more detailed information.



Indicates the end of accessory or equipment-dependent information.



Tightening torque.



Technical data.

NV

National-market version.

- OE Optional extra. BMW Motorrad optional extras are already completely installed during motorcycle production.
- OA Optional accessory. BMW Motorrad optional accessories can be purchased and installed at your authorized BMW Motorrad retailer.
- ABS Anti-Lock Brake System.
- ASC Automatic Stability Control.
- EWS Electronic immobilizer.
- D-ESA Electronic chassis and suspension adjustment.

DTC Dynamic Traction Control (optional equipment only in combination with Pro riding modes).

DWA Anti-theft alarm.

TPC Tire Pressure Control (TPC).

Equipment

When you ordered your BMW motorcycle, you chose various custom equipment items. This Rider's Manual describes optional equipment (OE) offered by BMW and selected optional accessories (OA). This explains why the manual may also contain descriptions of equipment which you have not ordered. Please note, too, that your motorcycle might not be exactly as illustrated in this manual on account of country-specific differences.

If your motorcycle features equipment that is not described here, you can find these features described in a separate manual.

Technical Data

All dimensions, weights and performance data contained this Rider's Manual refer to the German DIN standards and comply with their tolerance specifications. The technical data and specifications in this Rider's Manual serve as points of reference. The vehicle-specific data may vary, for instance due to the selected optional equipment, national-market version or country-specific measuring procedures. Detailed values can be obtained from the registration documents and the signs on the vehicle or from your authorized BMW Motorrad retailer or other qualified service partner or specialist workshop. The information on the vehicle

documents always takes precedence over the information in this Rider's Manual.

Notice concerning current status

The high safety and quality standards of BMW motorcycles are maintained by consistent, ongoing development efforts embracing their design, equipment and accessories. For this reason, some aspects of your motorcycle may vary from the descriptions in these operating instructions. In addition, BMW Motorrad cannot guarantee the total absence of errors. We hope you will appreciate that no claims can be recognized based on the data, illustrations or descriptions in this manual.

Additional sources of information

BMW Motorrad retailers

Your BMW Motorrad retailer is always happy to answer any of your questions.

Internet

The Rider's Manual for your vehicle, the operating and installation instructions for optional accessories and general BMW Motorrad information related to the technology or other features are available at **www.bmw-motorrad.com/service**.

Certificates and operating permits

The certificates for the vehicle and the official operating permits for possible accessories are available at **www.bmw-motorrad.com/certification**.

Data memory

General

Electronic control units are installed in the vehicle. Electronic control units process data received from vehicle sensors, self-generated data or data exchanged between control units, for example. Some control units are required for safe vehicle operation or provide driving assistance, such as driver assistance systems. Control units also make comfort and infotainment functions possible.

Information about the stored or exchanged data can be obtained from the vehicle manufacturer, such as in the form of a separate booklet.

Personal references

Every vehicle is marked with a unique vehicle identification number. Depending on the country, the vehicle owner can be iden-

tified using the vehicle identification number and license plate and with the help of the relevant authorities. There are also other ways to trace data obtained from the vehicle back to the rider or vehicle owner, such as via the used ConnectedDrive Account.

Data privacy laws

In accordance with applicable data privacy laws, vehicle users have certain rights over the vehicle manufacturer or company that collects or processes personal data.

Vehicle users have the right to obtain comprehensive information without charge from the locations that store the vehicle user's personal data.

These locations may be:

- The vehicle manufacturer
- Qualified service partners
- Specialist workshops

– Service providers

Vehicle users may request information about the type of personal data that is stored, the purpose for which the data will be used and the source of the data. This information can only be obtained by a registered owner or a person with written proof authorizing use of the vehicle.

The right to information also includes information related to data transmitted to other companies or locations.

The vehicle manufacturer's website contains the appropriate privacy policy notices. The privacy policy notices contain information on the right to delete or correct data. The vehicle manufacturer also provides the manufacturer contact information and the contact information of the data security officer.

The vehicle owner can have a BMW Motorrad retailer or other

qualified service partner or specialist workshop read out the data stored in the vehicle for a fee if required.

The vehicle data is read out via the power socket required by law for on-board diagnosis (OBD) in the vehicle.

Legal requirements for the disclosure of data

The vehicle manufacturer is required by the law applicable in this context to provide authorities with the data stored by the manufacturer. Providing this data within the scope required is on a case-by-case basis, for instance to clarify a criminal offense.

Government agencies are authorized by the law applicable in this context to read out the data from the vehicle themselves in individual cases.

Operating data in the vehicle

Control units process data so that the vehicle can run.

Examples of these include:

- Status messages from the vehicle and its individual components, such as wheel RPM, wheel speed and deceleration
- Environmental conditions, such as temperature

The data is processed only in the vehicle itself and is usually temporary. The data is not stored beyond the period in which the vehicle is operating.

Electronic components such as control units contain components for storing technical information. This may be information about the vehicle's condition, component load, events or faults stored temporarily or permanently.

This information generally documents the condition of a com-

ponent, module, system or the surrounding area; for example:

- Operating conditions of system components, such as fill levels and tire pressure
- Malfunctions and faults in key system components, such as lights and brakes
- Vehicle responses in specific driving situations, such as activation of dynamic driving systems
- Information about events causing damage to the vehicle

The data is necessary for providing control unit functions. In addition, it is used by the vehicle manufacturer to detect and eliminate malfunctions as well as to optimize vehicle functions.

The majority of this data is temporary and is processed only within the vehicle itself. Only a small amount of event-driven

data is stored in the event data recorder and fault memory.

When a vehicle is serviced, such as for repairs, servicing processes, warranty cases and quality assurance measures, this technical information can be read out from the vehicle together with the vehicle identification number.

The information can be read out by a BMW Motorrad retailer or other qualified service partner or specialist workshop. The power socket required by law for on-board diagnosis (OBD) in the vehicle is used to read out the data. The data is collected, processed and used by the respective service network locations. The data documents the vehicle's technical states and helps with fault finding, compliance with warranty obligations and quality improvements.

The manufacturer also has product monitoring obligations arising from product liability law. The vehicle manufacturer requires technical data from the vehicle in order to fulfill these obligations. The data from the vehicle can also be used to verify customer warranty and guarantee claims. The fault memory and event data recorder in the vehicle can be reset by a BMW Motorrad retailer or other qualified service partner or specialist workshop as part of repair work or servicing.

Data input and data transfer in the vehicle

General

Depending on the equipment, comfort settings and individualized settings in the vehicle can be saved and changed or reset at any time.

Examples of these include:

- Windshield position settings
- Chassis and suspension adjustment settings

It is possible to introduce data into the vehicle entertainment and communication system via a smartphone, for instance.

Depending on the individual equipment, this includes:

- Multimedia data, such as music for playback
- Address book data for use in conjunction with a communication system or integrated navigation system
- Entered navigation destinations
- Data about the use of internet services. This data can be stored locally in the vehicle or is on a device connected to the vehicle, such as a smartphone, USB stick or MP3 player. If this data is saved in the vehi-

cle, it can be deleted at any time.

This data is transmitted to third parties only upon personal request as part of the use of online services. The data transmitted depends on the selected settings when using the services.

Integrating mobile end devices

Depending on the equipment, mobile end devices connected to the vehicle, such as smartphones, are controlled using the vehicle's controls.

This enables audio and visual output from mobile end devices through the multimedia system. At the same time, certain information is transmitted to the mobile end device. This includes for instance position data and other general vehicle data, depending on the type of integration, and makes it possible to optimize the use of selected apps, such

as those for navigation or music playback.

The way the data is processed further is determined by the provider of the particular app used. The range of possible settings depends on the particular app and the operating system of the mobile end device.

Services

General

If the vehicle has a mobile phone connection, this connection makes it possible to exchange data between the vehicle and other systems. The mobile phone connection is made possible through the vehicle's transmitter and receiver or via personally integrated mobile end devices such as smartphones. Online functions, as they are called, are used over this mobile phone connection. These include online services and

apps provided by the vehicle manufacturer or other providers.

Vehicle manufacturer services

In the case of the vehicle manufacturer's online services, the particular functions are described at the appropriate location, such as in the Rider's Manual or on manufacturer's website. The relevant legal information on data privacy is also provided there. Personal data may be used in order to provide online services. The data is exchanged over a secure connection, i.e. with the vehicle manufacturer's IT systems which are intended for this purpose.

Any collection, processing and use of personal data that goes beyond the provision of services take place only as permitted by law, on the basis of a contractual agreement or as a result of consent. It is also possible to have

the entire data connection activated or deactivated. This is not the case for legally prescribed functions.

Services of other providers



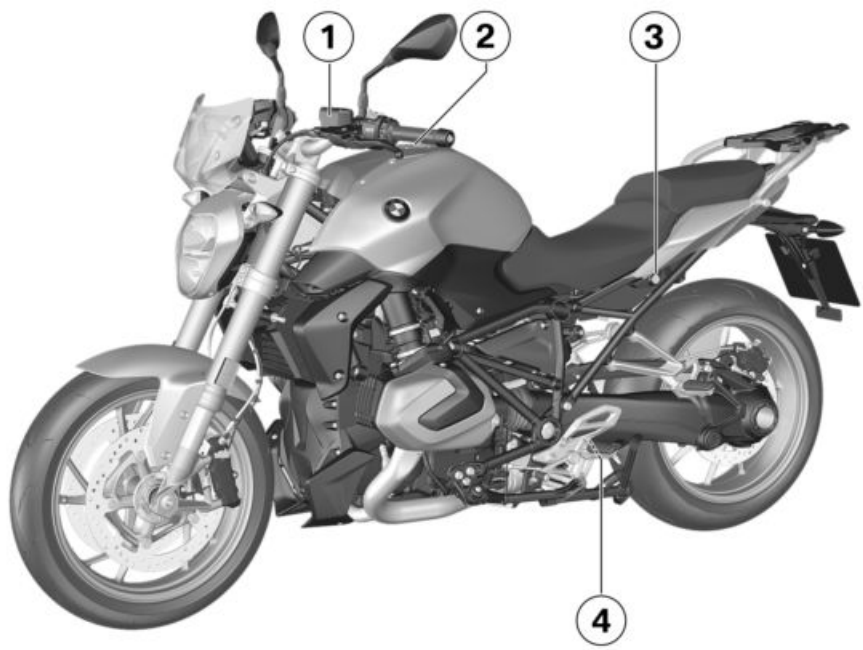

When using the online services of other providers, these services are subject to the responsibility and the data protection and usage conditions of the respective provider. The vehicle manufacturer has no control over the content exchanged via these services. Information about the type, scope and purpose of collecting and using personal data as part of third-party services can be obtained from the particular service provider.

Overviews

General view, left side.....	15
General view, right side	17
Underneath the seat	18
Multifunction switch, left	19
Multifunction switch, right.....	21
Instrument cluster	22



General view, left side

- 1 Clutch fluid reservoir
( 167)
- 2 Fuel filler opening
( 136)
- 3 Seat lock ( 85)
- 4 Adjuster for rear damping (at the bottom on the spring strut) ( 120)

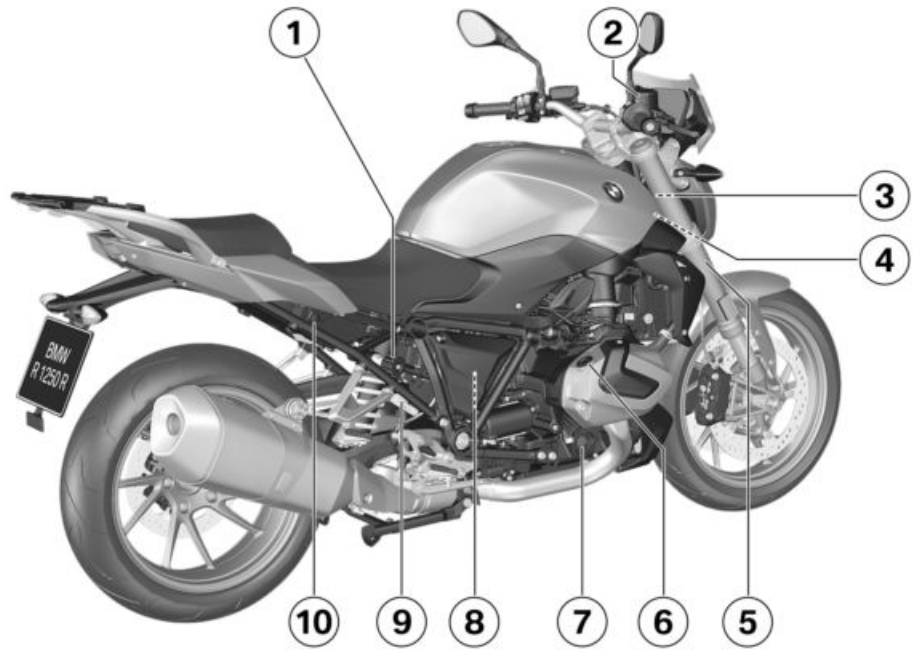

General view, right side

- 1 Adjuster for spring preload, rear (➡ 119)
- 2 Brake-fluid reservoir, front (➡ 165)
- 3 Vehicle identification number (on steering head at right)
Type plate (on steering head at left)
- 4 Coolant level indicator (➡ 167)
Coolant tank (➡ 168)
- 5 Tire inflation pressure table
- 6 Oil filler opening (➡ 162)
- 7 Engine oil indicator (➡ 161)
- 8 Behind the side trim panel:
Battery (➡ 182)
Remote positive terminal (➡ 181)
Data link connector (➡ 188)
- 9 Brake-fluid reservoir, rear (➡ 166)
- 10 Onboard power socket (➡ 192)

Underneath the seat

- 1 Fuses (➡ 186)
- 2 Rider's Manual (US Model)
- 3 Standard tool kit (➡ 158)
- 4 Load capacity table

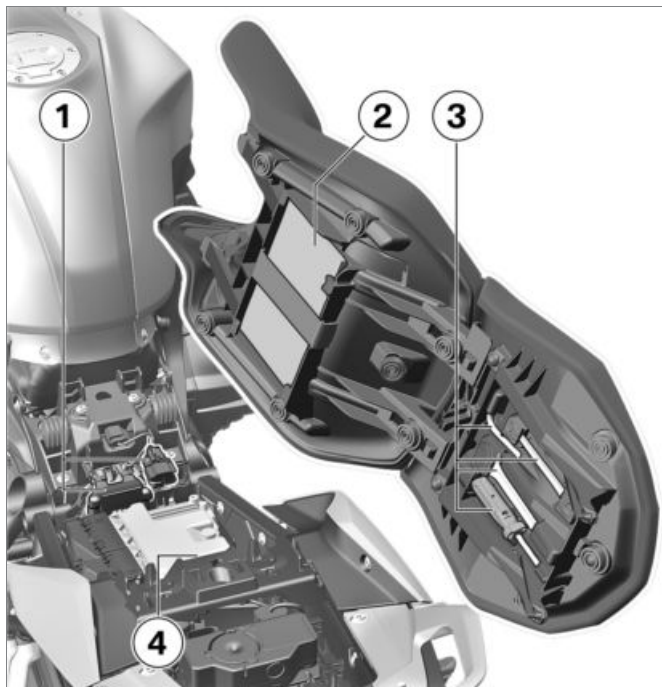

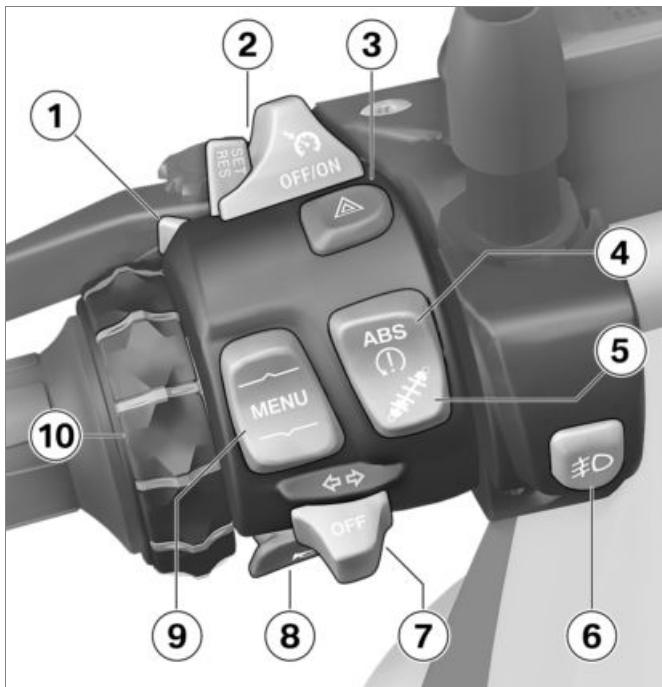

Multifunction switch, left

- 1 High-beam headlight and headlight flasher (➡ 64)
- 2 – with cruise control^{OE}
Cruise-control system (➡ 77).
- 3 Hazard warning flashers (➡ 66)
- 4 ABS (➡ 67)
ASC/DTC (➡ 69)
- 5 – with Dynamic ESA^{OE}
Dynamic ESA adjustment options (➡ 71)
- 6 – with LED additional headlight^{OA}
Additional headlight (➡ 65).
- 7 Turn indicators (➡ 66)
- 8 Horn
- 9 Rocker button MENU (➡ 89)

- 10** Multi-Controller
Operating elements
( 89)

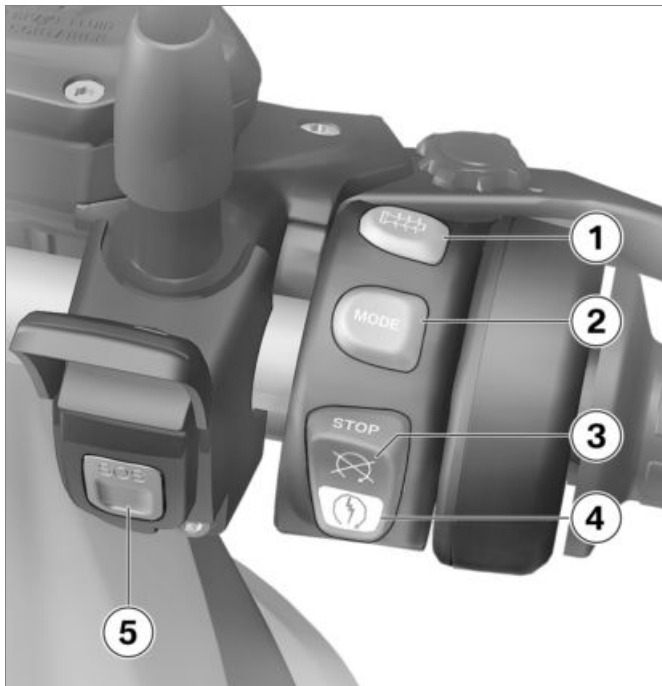

Multifunction switch, right

- 1 – with heated grips^{OE}
Heated handlebar grips (➡ 84).
- 2 Riding mode (➡ 73)
- 3 Emergency on/off switch
(kill switch) (➡ 64)
- 4 Starter button
Start the engine (➡ 127).
- 5 SOS button

Instrument cluster

- 1 Indicator and warning lights (►► 24)
- 2 – with Style HPO^{OE}
Shiftpoint light (►► 132)
- 3 TFT display (►► 25)
(►► 27)
- 4 Anti-theft alarm LED
– with anti-theft alarm system (DWA)^{OE}
Alarm signal (►► 83)
– with Keyless Ride^{OE}
Indicator light for radio-operated key
Switching on ignition (►► 61).
- 5 Photosensor (for adjusting brightness of instrument lighting)

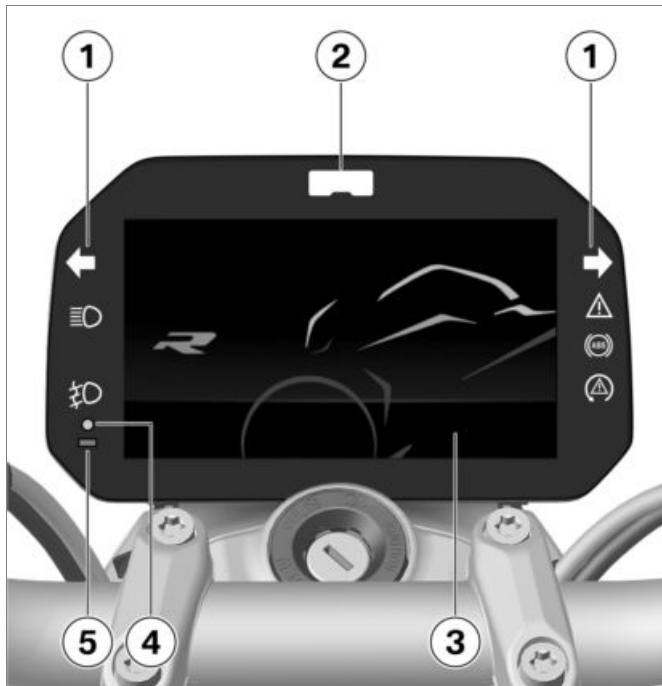

Displays

Indicator and warning lights	24
TFT display in Pure Ride view	25
TFT display in the View menu	27
Warning lights	28

Indicator and warning lights

- 1 Turn indicator, left
Operating turn signals
([►►► 66](#)).
- 2 High beam ([►►► 64](#))
- 3 General warning light
([►►► 28](#))
- 4 Turn indicator, right
- 5 ASC ([►►► 50](#))
– with riding modes Pro^{OE}
DTC ([►►► 50](#))
- 6 ABS ([►►► 67](#))
- 7 – with LED additional
headlight^{OA}
Additional headlight
([►►► 65](#)).

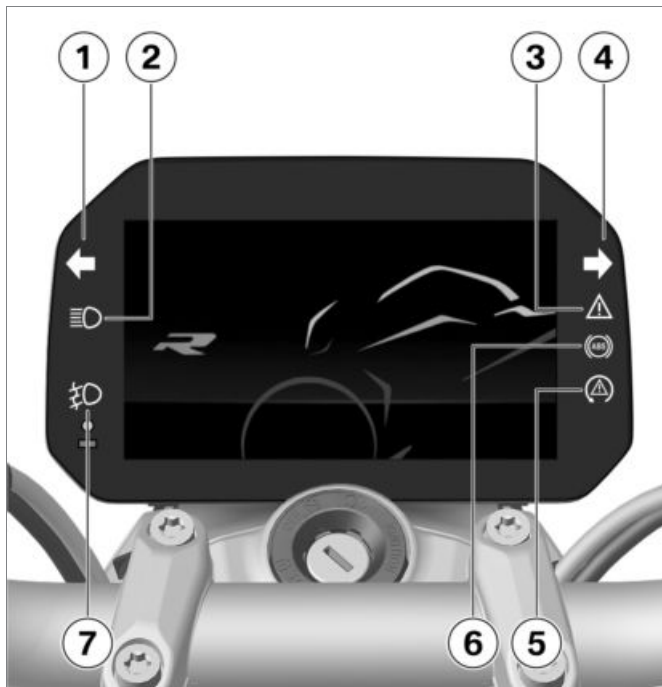

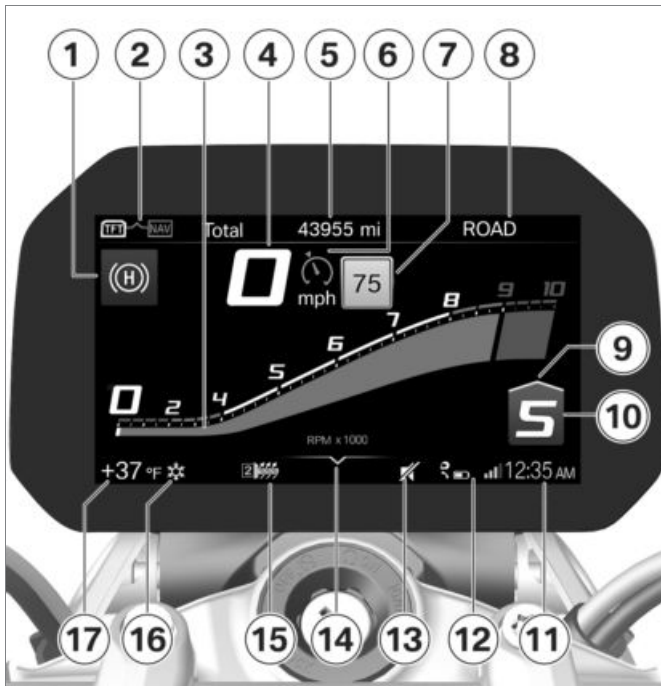

TFT display in Pure Ride view

- 1 Hill Start Control (➡ 53)
- 2 Operating focus change (➡ 93)
- 3 Tachometer (➡ 96)
- 4 Speedometer
- 5 Rider info. status line (➡ 94)
- 6 – with cruise control^{OE}
Cruise-control system (➡ 77).
- 7 Speed Limit Info (➡ 95)
- 8 Riding mode (➡ 73)
- 9 Upshift recommendation (➡ 97)
- 10 Gear indicator, shows "N" in neutral (idling).
- 11 Clock (➡ 97)
- 12 Connection status (➡ 99)
- 13 Mute (➡ 97)
- 14 Operating assistance
- 15 Heated grip settings (➡ 84)

- 16 Outside temperature warning ( 38)
- 17 Outside temperature

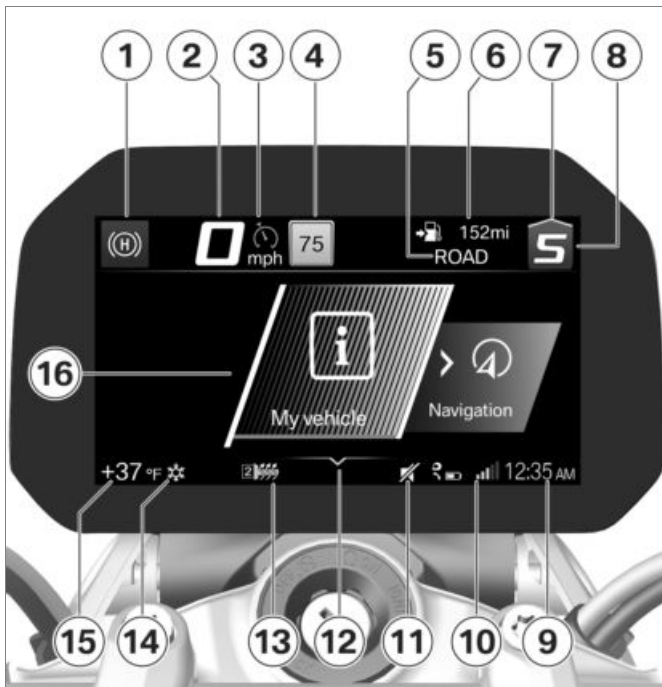

TFT display in the View menu

- 1 Hill Start Control (➡ 53)
- 2 Speedometer
- 3 – with cruise control^{OE}
Cruise-control system (➡ 77).
- 4 Speed Limit Info (➡ 95)
- 5 Riding mode (➡ 73)
- 6 Rider info. status line (➡ 94)
- 7 Upshift recommendation (➡ 97)
- 8 Gear indicator, shows "N" in neutral (idling).
- 9 Clock
- 10 Connection status
- 11 Mute (➡ 97)
- 12 Operating assistance
- 13 Heated grip settings (➡ 84)
- 14 Outside temperature warning (➡ 38)
- 15 Outside temperature

16 Menu area

Warning lights

Display

Warnings are displayed with appropriate warning lights. Warnings are indicated by the general warning light in conjunction with a dialog in the TFT display. The general warning light lights up in either yellow or red depending on the urgency of the warning.



The general warning light lights up for the most urgent warning.

You will find an overview of the potential warnings on the following pages.



Check Control display

The messages in the display are shown differently in the display. Different colors and characters are used depending on the priority:

- Green CHECK OK **1**: no message, values optimal.
- White circle with small "i" **2**: information.
- Yellow warning triangle **3**: warning message, value not optimal.
- Red warning triangle **3**: warning message, value critical

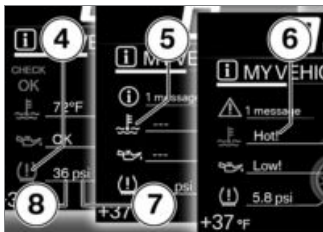

Value display

The symbols **4** differ in their display. Different colors are used depending on the assessment of value. Instead of numerical values **8** with units **7**, texts **6** are also displayed:

Color of the symbol

- Green: (OK) current value is optimal.
- Blue: (Cold!) current temperature is too low.
- Yellow: (Low! /High!) current value is too low or too high.
- Red: (Hot! /High!) current temperature or value is too high.

- White: (---) there is no valid value. Instead of the value, dashes **5** are displayed.

NOTICE

The evaluation of the individual values is possible in part only after a certain riding duration or speed. If a measured value cannot yet be displayed due to unfulfilled measurement conditions, dashes are displayed instead as placeholders. As long as no valid measured value is available, no evaluation is carried out in the form of a colored symbol.◀













Check Control dialog

Messages are output as Check Control dialog **1**.

- If several Check Control messages of the same priority are present, the messages change in the order in which they occur, until they are acknowledged.
- If the symbol **2** is active, this can be acknowledged by tilting the Multi-Controller to the left.
- Check Control messages are dynamically attached as additional tabs to the pages in the menu My vehicle (➡ 91). The message can be called up

again as long as the error persists.











Overview of warning indicators

Indicator and warning lights	Display text	Meaning
	 Ice crystal symbol is displayed.	Outside temperature warning (►►► 38)
 General warning light lights up yellow.	 Key remote not in range.	Key remote outside of the reception area (►►► 38)
 General warning light lights up yellow.	 Key remote battery at 50%.	Replacing the battery of the key fob transmitter (►►► 39)
	 Key remote battery low.	
 General warning light lights up yellow.	 Displayed in yellow.	Vehicle voltage too low (►►► 39)
	 Vehicle voltage low.	
 General warning light shows red.	 Displayed in red.	Vehicle voltage critical (►►► 39)

Indicator and warning lights

Display text











Meaning











		Vehicle voltage critical!	Vehicle voltage critical (➡ 39)	
	General warning light lights up yellow.		The faulty light source is displayed.	Light source defect (➡ 40)
		Anti-theft alarm batt. capacity low.	Anti-theft alarm battery low charge (➡ 41)	
	General warning light lights up yellow.		Anti-theft alarm battery discharged.	Anti-theft alarm system battery discharged (➡ 41)
		Engine oil level. Check engine oil level	Electronic oil-level check: check engine oil level (➡ 42)	
	General warning light shows red.		Coolant temperature too high!	Coolant temperature too high (➡ 43)
	General warning light lights up yellow.		No communication with engine control.	Engine control failure (➡ 43)

Indicator and warning lights

Display text

Meaning

 General warning light lights up yellow.	 Fault in the engine control.	Engine in emergency-operation mode (▶▶▶▶ 43)
 General warning light flashes yellow.	 Serious fault in engine control.	Serious fault in the engine control (▶▶▶▶ 44)
 General warning light lights up yellow.	 Displayed in yellow.	Tire pressure at the limits of the permissible tolerance (▶▶▶▶ 45)
	 Tire pressure not at setpoint.	
 General warning light flashes red.	 Displayed in red.	Tire pressure is outside the approved tolerance range (▶▶▶▶ 46)
	 Tire pressure not at setpoint.	
	 Tire press. monitor. Loss of pressure.	

Indicator and warning lights	Display text	Meaning
	 "----"	Transmission fault (►►► 47)
 General warning light lights up yellow.	 "----"	Sensor faulty or system fault (►►► 47)
 General warning light lights up yellow.	 TPM sensors battery low	Battery of the tire pressure sensor weak (►►► 48)
	 Fall sensor faulty.	Fall sensor defective (►►► 48)
	 Side stand monitoring faulty.	Side stand monitoring faulty (►►► 48)
 ABS indicator and warning light flashes.		ABS self-diagnosis not completed (►►► 49)
 ABS indicator and warning light lights up.	 Off!	ABS deactivated (►►► 49)
	 ABS deactivated.	

Indicator and warning lights

Display text

Meaning



ABS indicator and warning light lights up.



Limited ABS availability!

ABS fault (→ 49)



ABS indicator and warning light lights up.



ABS failure!

ABS failure (→ 49)



ABS indicator and warning light lights up.



ABS Pro failure!

ABS Pro failure (→ 50)



ASC/DTC indicator and warning light flashes quickly.

ASC/DTC intervention (→ 50)



ASC/DTC indicator and warning light flashes slowly.

ASC/DTC self-diagnosis routine not completed (→ 50)



ASC/DTC indicator and warning light lights up.



Off!

ASC/DTC switched off (→ 51)













Traction control deactivated.

Indicator and warning lights

Display text

Meaning

	ASC/DTC indicator and warning light lights up.	 Traction control limited.	Limited ASC/DTC availability (►►► 51)
	ASC/DTC indicator and warning light lights up.	 Traction control failure!	ASC/DTC error (►►► 51)
	General warning light lights up yellow.	 Spring strut adjustment faulty!	D-ESA fault (►►► 52)
		 Fuel reserve is being used up. Drive to the nearest filling station.	Fuel down to reserve (►►► 52)
		 Green stop symbol is displayed.	Hill Start Control active (►►► 53)
		 Yellow stop symbol flashes.	Hill Start Control is automatically deactivated (►►► 53)
		 Crossed-out stop symbol is displayed.	Hill Start Control cannot be activated (►►► 53)

Indicator and warning lights

Display text

Meaning



The gear indicator flashes.

Gear not trained (→ 53)



Left turn signal indicator light flashes green.

Hazard warning lights system switched on (→ 54)



Right turn signal indicator light flashes green.



Displayed in white.

Service due (→ 54)

Service due!



General warning light lights up yellow.



Displayed in yellow.

Service date missed (→ 54)

Service overdue!

Outside temperature

The outside temperature is displayed in the status line of the TFT display.

Engine heat can lead to spurious readings of ambient temperature when the motorcycle is stationary. If the effect of the engine heat becomes excessive, dashes are temporarily displayed instead of the value.



If the outside temperature falls below the following limit value, there is a risk of black ice formation.



Limit range for outside temperature

Approx. 37 °F (Approx. 3 °C)

When this temperature is fallen short of for the first time, the outside temperature display flashes together with the ice crystal sym-

bol in the status line of the TFT display.

Outside temperature warning



Ice crystal symbol is displayed.

Possible cause:



The outside temperature measured on the motorcycle is less than:

Approx. 37 °F (Approx. 3 °C)



WARNING

Risk of black ice, even above 37 °F (3 °C)

Accident hazard

- At a low outside temperature, icy conditions must be expected on bridges and in shady road areas. ◀
- Think well ahead when driving.

Key remote outside of the reception area

– with Keyless Ride^{OE}



General warning light lights up yellow.



Key remote not in range. It is not possible to turn on the ignition again.

Possible cause:

The communication between the key remote and the engine electronics is faulty.

- Check the battery in the key remote.
- with Keyless Ride^{OE}
- Replacing the battery of the key fob transmitter (▶▶▶ 63).
- Use the spare key for further travel.
- with Keyless Ride^{OE}
- If radio key is lost (▶▶▶ 62).
- If the Check Control dialogue appears while riding, remain

calm. You can continue riding, the engine will not turn off.

- Have any faulty key remotes replaced by a BMW Motorrad partner.

Replacing the battery of the key fob transmitter



General warning light lights up yellow.



Key remote battery at 50%. No functional limitation.



Key remote battery low. Limited central locking function. Change battery.

Possible cause:

- The battery for the key fob transmitter is no longer charged to full capacity. Operation of the key fob transmitter is only ensured for a limited time.

– with Keyless Ride^{OE}

- Replacing the battery of the key fob transmitter (▶▶▶ 63).

Vehicle voltage too low



General warning light lights up yellow.



Displayed in yellow.



Vehicle voltage low. Switch off unneeded consumers.



WARNING

Failure of vehicle systems

Accident hazard

- Do not continue riding.◀

The battery is not being charged. If the journey is continued, the vehicle electronics will discharge the battery.



NOTICE

If the 12-V battery is inserted incorrectly or the terminals reversed (e.g. when jump starting), it can blow the fuse for the alternator regulator.◀

Possible cause:

Alternator or alternator drive faulty, battery faulty or fuse for alternator regulator blown.

- Have the malfunction corrected as soon as possible at an authorized specialist workshop, preferably an authorized BMW Motorrad retailer.

Vehicle voltage critical



General warning light shows red.



Displayed in red.

 Vehicle voltage critical! Consumers were switched off Check battery condition.

WARNING

Failure of vehicle systems

Accident hazard

- Do not continue riding.◀

The battery is not being charged. If the journey is continued, the vehicle electronics will discharge the battery.

NOTICE

If the 12-V battery is inserted incorrectly or the terminals reversed (e.g. when jump starting), it can blow the fuse for the alternator regulator.◀

Possible cause:

Alternator or alternator drive faulty, battery faulty or fuse for alternator regulator blown.

- Have the malfunction corrected as soon as possible at an authorized specialist workshop, preferably an authorized BMW Motorrad retailer.

Light source defect

 General warning light lights up yellow.

 The faulty light source is displayed:

 High beam faulty!

 Front left turn indicator faulty! or Front right turn indicator faulty!

 Low beam faulty!

 Front parking lamp faulty!

 Daytime riding light faulty!

– with LED additional headlight^{OA}

 Left auxiliary headlight faulty! or Right auxiliary headlight faulty!◀

 Tail light faulty!

 Brake light faulty!

 Rear left turn indicator faulty! or Rear right turn indicator faulty!

 License plate light faulty!

– Have checked by a specialist workshop.

WARNING

Overlooking the vehicle in traffic due to a defective light source on the vehicle

Safety risk

- Replace defective bulbs as soon as possible; it is best always to carry a complete set of spare bulbs on the motorcycle. ◀

Possible cause:

One or more lights are faulty.

- Identify faulty lights by visually inspecting them.
- Replace LED headlights (▮▮▮ 181).
- Replacing front and rear turn indicator light sources (▮▮▮ 179).
- Replacing LED tail light (▮▮▮ 181).

Anti-theft alarm battery low charge

– with anti-theft alarm system (DWA)^{OE}

 Anti-theft alarm batt. capacity low. No limitations. Arrange an appointment at a specialist workshop.

NOTICE

This fault message is only shown for a short time immediately following the Pre-Ride-Check. ◀

Possible cause:

The anti-theft alarm battery no longer has its full capacity. The operation of the anti-theft alarm system is only ensured for a limited time with the motorcycle battery disconnected.

- Contact an authorized service facility, preferably an authorized BMW Motorrad retailer.

Anti-theft alarm system battery discharged

– with anti-theft alarm system (DWA)^{OE}

 General warning light lights up yellow.

 Anti-theft alarm battery discharged. No independent alarm. Arrange an appointment at a specialist workshop.

NOTICE

This fault message is only shown for a short time immediately following the Pre-Ride-Check. ◀

Possible cause:

The anti-theft alarm system battery is completely discharged. Operation of the anti-theft alarm system is no longer ensured when the motorcycle's battery is disconnected.

- Contact an authorized service facility, preferably an authorized BMW Motorrad retailer.

Electronic oil-level check



The electronic oil-level check evaluates the oil level in the engine as OK or Low!

The following conditions must be satisfied in order to use the electronic oil-level check; multiple measurements may be necessary:

- Rider is sitting on the motorcycle and the motorcycle has been ridden at at least 10 km/h beforehand.
- Engine idling for at least 20 seconds.
- Engine is at operating temperature.
- Side (prop) stand is retracted and motorcycle is not resting on a center stand.

- No brake is engaged and hill start control (HSC) is not active.
- Motorcycle stands vertically on a level surface.
- The spring strut is set according to the load status, or D-ESA is in the Auto loading mode.

If the measurement is incomplete or the conditions specified above are not fulfilled, an assessment of the oil level is not possible. Dashes (---) are indicated in place of the note.

Electronic oil-level check: check engine oil level.



Engine oil level.
Check engine oil level.

Possible cause:

The electronic oil level sensor has detected a low engine oil level. If the motorcycle is not standing vertically on a level surface, the message can also appear even when the oil level is correct. At next refueling stop:

- Checking the engine oil level (→ 161).

If the oil level is too low in the inspection glass:

- Topping up the engine oil (→ 162).

If the oil level is correct:

- Check whether the conditions for the electronic oil level check are fulfilled.

If the note appears multiple times even though the oil level is slightly below the MAX mark:

- Contact an authorized workshop, preferably an authorized BMW Motorrad retailer.

Coolant temperature too high



General warning light shows red.



Coolant temperature too high! Check coolant level. Carry on at moderate pace to cool.



ATTENTION

Riding with overheated engine

Engine damage

- Be sure to observe the measures listed below. ◀

Possible cause:

Coolant level is too low.

- Checking coolant level (▶▶▶ 167).

If coolant level is too low:

- Let the engine cool down.
- Topping up coolant (▶▶▶ 168).
- Have the coolant system checked at a specialist

workshop, preferably by an authorized BMW Motorrad retailer.

Possible cause:

The coolant temperature is too high.

- If possible, continue driving in the part-load range to cool down the engine.

If the coolant temperature is frequently too high:

- Have the fault corrected as soon as possible by a specialist workshop, preferably an authorized BMW Motorrad retailer.

Engine control failure



General warning light lights up yellow.



No communication with engine control. Multiple sys. affected. Ride carefully to the next specialist workshop.

Engine in emergency-operation mode



General warning light lights up yellow.



Fault in the engine control. Onward journey possible. Ride carefully to next specialist workshop.



WARNING

Unusual handling when the engine is in emergency operation

Accident hazard

- Avoid rapid acceleration and passing maneuvers. ◀

Possible cause:

The engine control unit has diagnosed a fault which impairs the engine performance or throttle response. The engine is running in the emergency-operation mode. In exceptional cases, the

engine stops and can no longer be started.

- Have the malfunction corrected as soon as possible at an authorized specialist workshop, preferably an authorized BMW Motorrad retailer.
- » It is possible to continue riding, however the engine performance and engine speed range may be impaired and not function as normal.

Serious fault in the engine control



General warning light flashes yellow.



Serious fault in engine control. Onward journey possible. Damage possible. Have checked by a workshop.



WARNING

Damage to engine during emergency operation

Accident hazard

- Drive slowly and avoid rapid acceleration and passing maneuvers.
- If possible, have the vehicle picked up and the fault eliminated at a specialist workshop, preferably an authorized BMW Motorrad retailer. ◀

Possible cause:

The engine control unit has diagnosed a fault, which can lead to a severe secondary fault. The engine is in the emergency-operation mode.

- Continued driving is possible, however it is not recommended.
- Avoid high load and engine speed ranges if possible.

- Have the malfunction corrected as soon as possible at an authorized specialist workshop, preferably an authorized BMW Motorrad retailer.

Tire inflation pressure

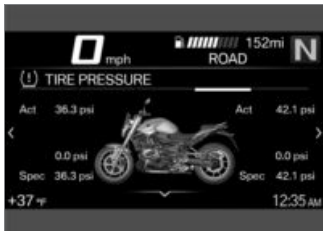

- with tire pressure monitor (TPM)^{OE}

As well as the menu window **MY VEHICLE** and the Check Control messages, the **TIRE PRESSURE** window is also used to display tire pressures:





The values on the left relate to the front wheel and the values on the right relate to the rear wheel. The pressure differential is displayed via the actual and nominal tire pressure.

Immediately after switching on the ignition only dashes are displayed. The transfer of the tire pressure values does not begin until the minimum speed is exceeded for the first time:

	TPC/RDC sensor is not active
	min 19 mph (min 30 km/h) (The TPC/RDC sensor does not transmit a signal to the motorcycle until this minimum speed has been exceeded.)
	The tire pressures are shown in the TFT display with temperature compensation and are always based on the following tire air temperature:
	68 °F (20 °C)

 If the tire symbol appears yellow or red at the same time, the display is a warning. The pressure differential is highlighted with an exclamation mark of the same color.

 If the level concerned is borderline in terms of the permissible tolerance, the general warning light also lights up yellow.

 If the monitored tire inflation pressure is outside the specified range the general warning light will flash red.

For further information about the BMW Motorrad tire pressure monitor, see the "Technology in detail" chapter from page (➔ 150).

Tire pressure at the limits of the permissible tolerance

– with tire pressure monitor (TPM)^{OE}

 General warning light lights up yellow.



Displayed in yellow.



Tire pressure not at setpoint. Check tire pressure.

Possible cause:

The measured tire pressure is within the limit range of the permissible tolerance.

- Correct tyre pressure.
- Before adjusting the tire pressure, check the information on temperature compensation and tire pressure adjustment in the "Technology in detail" chapter:
 - » Temperature compensation (▣▣▣▶ 151)
 - » Tire pressure adjustment (▣▣▣▶ 151)
 - » The target tire pressures can be found in the following locations:
 - On the back cover of the rider's manual

- Display in the TIRE PRESSURE view
- Sign on the fixed fork tube

Tire pressure is outside the approved tolerance range

- with tire pressure monitor (TPM)^{OE}



General warning light flashes red.



Displayed in red.



Tire pressure not at setpoint. Stop immediately! Check tire pressure.



Tire press. monitor. Loss of pressure. Stop immediately! Check tire pressure.



WARNING

Tire pressure is outside the approved tolerance range.

Risk of accident, deterioration in the handling characteristics of the vehicle.

- Adjust the driving style.◀

Possible cause:

The measured tire pressure is outside of the permissible tolerance.

- Check the tires for damage and driveability.

Can the tire still be driven on:

- Correct the tire pressure at the next opportunity.
- Before adjusting the tire pressure, check the information on temperature compensation and tire pressure adjustment in the "Technology in detail" chapter:
 - » Temperature compensation (▣▣▣▶ 151)

- » Tire pressure adjustment (►► 151)
- » The target tire pressures can be found in the following locations:
 - On the back cover of the rider's manual
 - Display in the TIRE PRESSURE view
 - Sign on the fixed fork tube
 - Have the tires checked by a specialist workshop for damage, preferably an authorized BMW Motorrad retailer.

In the event of uncertainty about the driveability of the tire:

- Do not continue riding.
- Inform roadside assistance.

Transmission fault

- with tire pressure monitor (TPM)^{OE}



"----"

Possible cause:

The vehicle has not reached the minimum speed (►► 150).



TPC/RDC sensor is not active

min 19 mph (min 30 km/h)
(The TPC/RDC sensor does not transmit a signal to the motorcycle until this minimum speed has been exceeded.)

- Observe the TPM display at higher speed.
-  Only when the general warning light also lights up is this a permanent fault.
In this case:
 - Have fault eliminated at a specialist service facility, preferably an authorized BMW Motorrad retailer.

Possible cause:

The radio link to the TPM sensors is disrupted. There are radio systems in the surrounding area that are causing interference to the connection between the TPM control unit and the sensors.

- Observe the TPM display in different surroundings.



Only when the general warning light also lights up is this a permanent fault.

In this case:

- Have fault eliminated at a specialist service facility, preferably an authorized BMW Motorrad retailer.

Sensor faulty or system fault

- with tire pressure monitor (TPM)^{OE}



General warning light lights up yellow.



"----"

Possible cause:

Wheels without installed TPC/RDC sensors are mounted.

- Retrofit wheel set with TPM sensors.

Possible cause:

1 or 2 TPM sensors have failed or there is a system fault.

- Have fault eliminated at a specialist service facility, preferably an authorized BMW Motorrad retailer.

Battery of the tire pressure sensor weak

– with tire pressure monitor (TPM)^{OE}



General warning light lights up yellow.



TPM sensors battery low Function limited. Have checked by a specialist workshop.



NOTICE

This fault message is only shown for a short time immediately following the Pre-Ride-Check. ◀

Possible cause:

The battery for the tire pressure sensor is no longer charged to full capacity. Operation of the tire pressure control is only ensured for a limited time.

- Contact an authorized service facility, preferably an authorized BMW Motorrad retailer.

Fall sensor defective



Fall sensor faulty. Have checked by a specialist workshop.

Possible cause:

The fall sensor is not functioning.

- Contact an authorized service facility, preferably an authorized BMW Motorrad retailer.

Side stand monitoring faulty



Side stand monitoring faulty. Onward journey possible. Stop engine when stationary! Have checked by workshop.

Possible cause:

The side-stand switch or its wiring is damaged.

- Contact an authorized service facility, preferably an authorized BMW Motorrad retailer.

ABS self-diagnosis not completed

 ABS indicator and warning light flashes.

Possible cause:

 ABS self-diagnosis routine not completed

ABS is not available, as the self-diagnosis routine was not completed. (The motorcycle must reach a specified minimum speed before the system can check operation of the wheel speed sensors: 3 mph (5 km/h))

- Ride off slowly. Please note that the ABS function is only available after the self-diagnosis has completed.

ABS deactivated

 ABS indicator and warning light lights up.

 Off!

 ABS deactivated.

Possible cause:

The ABS system was deactivated by the rider.

- Switch on ABS function (▶▶▶ 68).

ABS fault

 ABS indicator and warning light lights up.

 Limited ABS availability! Onward journey possible. Ride carefully to next specialist workshop.

Possible cause:

The ABS control unit has detected an error. The partial integral brake and the Dynamic Brake Control function have failed. The ABS function is limited.

- It remains possible to continue riding. Observe additional information on special situations which can lead to ABS fault messages (▶▶▶ 143).
- Have the malfunction corrected as soon as possible at an authorized specialist workshop, preferably an authorized BMW Motorrad retailer.

ABS failure

 ABS indicator and warning light lights up.

 ABS failure! Onward journey possible. Ride carefully to next specialist workshop.

Possible cause:

The ABS control unit has detected an error. The ABS function is not available.

- It remains possible to continue riding. Observe additional information on special conditions that can lead to an ABS error message (▣➔ 143).
- Have the malfunction corrected as soon as possible at an authorized specialist workshop, preferably an authorized BMW Motorrad retailer.

ABS Pro failure

– with riding modes Pro^{OE}



ABS indicator and warning light lights up.



ABS Pro failure! Onward journey possible. Ride carefully to next specialist workshop.

Possible cause:

The ABS Pro control unit has detected a fault. The ABS Pro function is not available. The ABS function remains available. ABS only supports braking in straight-ahead riding.

- It remains possible to continue riding. Observe additional information on special situations which can lead to an ABS Pro fault message (▣➔ 143).
- Have the malfunction corrected as soon as possible at an authorized specialist workshop, preferably an authorized BMW Motorrad retailer.

ASC/DTC intervention



ASC/DTC indicator and warning light flashes quickly.

ASC/DTC has detected instability at the rear wheel and responded by reducing the torque. The indicator and warning light flashes

longer than the ASC/DTC intervention lasts. This feature continues to furnish the rider with visual feedback confirming that the system has initiated active closed-loop intervention even after the critical situation has passed.

ASC/DTC self-diagnosis routine not completed



ASC/DTC indicator and warning light flashes slowly.

Possible cause:



ASC/DTC self-diagnosis routine not completed

The ASC/DTC function is not available, as the self-diagnosis function has not been completed. (To check wheel speed sensors, motorcycle must reach a minimum speed with engine running: min 3 mph (min 5 km/h))

- Ride off slowly. The ASC/DTC indicator and warning light must go out after a few meters.

If the ASC/DTC indicator and warning light continues flashing:

- Contact an authorized workshop, preferably an authorized BMW Motorrad retailer.

ASC/DTC switched off

 ASC/DTC indicator and warning light lights up.

 Off!

 Traction control deactivated.

Possible cause:

The ASC/DTC system was deactivated by the rider.

- Switching the ASC/DTC function on (➡ 70).

Limited ASC/DTC availability

 ASC/DTC indicator and warning light lights up.

 Traction control limited. Onward journey possible. Ride carefully to next specialist workshop.

Possible cause:

The ASC/DTC control unit has detected a fault.

ATTENTION

Damage to components

Damage to sensors, for example, with the resultant malfunctions

- Do not carry along any objects under the rider's or passenger's seat.
- Secure vehicle tools. ◀
- Do not damage the rotational speed sensor.

- It must be noted that only limited ASC/DTC function is available.
- It remains possible to continue riding. Observe additional information on situations that can lead to a ASC/DTC fault (➡ 146).
- Have the malfunction corrected as soon as possible at an authorized specialist workshop, preferably an authorized BMW Motorrad retailer.

ASC/DTC error

 ASC/DTC indicator and warning light lights up.

 Traction control failure! Onward journey possible. Ride carefully to next specialist workshop.

Possible cause:

The ASC/DTC control unit has detected a fault.



ATTENTION

Damage to components

Damage to sensors, for example, with the resultant malfunctions

- Do not carry along any objects under the rider's or passenger's seat.
- Secure vehicle tools. ◀
- Do not damage the rotational speed sensor.
- It must be noted that the ASC/DTC function is not available at all or is restricted.
- It remains possible to continue riding. Observe additional information on situations that can lead to a ASC/DTC fault (▶▶▶ 146).
- Have the malfunction corrected as soon as possible at an authorized specialist workshop,

preferably an authorized BMW Motorrad retailer.

D-ESA fault

– with Dynamic ESA^{OE}



General warning light lights up yellow.



Spring strut adjustment faulty! Onward journey possible. Ride carefully to next specialist workshop.

Possible cause:

The D-ESA control unit has detected a fault. Damping action and/or the spring adjustment may be the cause. In the Auto loading mode, the cause may be a fault in the function of the riding position compensation. In this state, the motorcycle is probably heavily damped and is uncomfortable to drive, particularly on poor road-

ways. Alternatively, the spring setting may be set incorrectly.

- Have the malfunction corrected as soon as possible at an authorized specialist workshop, preferably an authorized BMW Motorrad retailer.
- » Dynamic ESA adjustment options (▶▶▶ 71)

Fuel down to reserve



Fuel reserve is being used up. Drive to the nearest filling station.



WARNING

Rough engine running or switching off of the engine due to a fuel shortage

Accident hazard, damage to catalytic converter

- Do not drive to the extent that the fuel tank is completely empty. ◀

Possible cause:

At the most, the fuel tank still contains the reserve fuel quantity.



Reserve fuel quantity

Approx. 1.1 gal (Approx. 4 l)

- Refueling procedure (➡ 136).

Hill Start Control active



Green stop symbol is displayed.

Possible cause:

The Hill Start Control (➡ 153) was activated by the rider.

- Switch Hill Start Control on and off (➡ 79).

Hill Start Control is automatically deactivated



Yellow stop symbol flashes.

Possible cause:

Hill Start Control was deactivated automatically.

- Side stand was folded out.
 - » Hill Start Control is deactivated when the side stand is folded out.
- Engine was stopped.
 - » Hill Start Control is deactivated when the engine is stopped.
- Using Hill Start Control (➡ 79).

Hill Start Control cannot be activated



Crossed-out stop symbol is displayed.

Possible cause:

The Hill Start Control can not be activated.

- Fold in side stand.
 - » Hill Start Control only functions when the side stand is folded in.
- Start engine.

- » Hill Start Control only functions with the engine running.

Gear not trained

– with Gearshift Assistant Pro^{OE}



The gear indicator flashes.
The gearshift assistant Pro has no function.

Possible cause:

– with Gearshift Assistant Pro^{OE}

The transmission sensor has not been completely trained.

- Engage idle position **N** and allow the engine to run for at least 10 seconds while parked to train the idle position.
- Shift all gears with clutch control and drive for at least 10 seconds in each engaged gear.
 - » The gear indicator stops flashing when the transmission sensor has been successfully trained.
- If the transmission sensor is completely trained, the

gearshift assistant Pro functions as described (▮▮▮▮ 152).

- If the training procedure is unsuccessful, have the fault corrected at a specialist workshop, preferably an authorized BMW Motorrad retailer.

Hazard warning lights system switched on

 Left turn signal indicator light flashes green.

 Right turn signal indicator light flashes green.

Possible cause:

The hazard warning lights system was switched on by the rider.

- Operating hazard warning flashers (▮▮▮▮ 66).

Service display

 If service is overdue, the due date or the odometer reading at which service was due

is accompanied by the 'General' warning light showing yellow.

If service is overdue, a yellow CC message is displayed. The displays for service, service date, and remaining distance are also highlighted with exclamation marks in the menu windows MY VEHICLE and SERVICE REQUIREMENTS.



NOTICE

If the service display appears more than a month before the service date, the current day's date must be reset in the instrument cluster. This situation can occur if the battery was disconnected.◀

Service due



Displayed in white.

Service due! Have a service performed at a specialist workshop.

Possible cause:

Service is due because of the driving performance or the date.

- Have service performed regularly by a specialist workshop, preferably an authorized BMW Motorrad retailer.
- » The operating and road safety of the vehicle remains unchanged.
- » The best-possible value retention of the vehicle is ensured.

Service date missed



General warning light lights up yellow.



Displayed in yellow.

Service overdue! Have a service performed at a specialist workshop.

Possible cause:

Service is overdue because of the riding performance or the date.

- Have service performed regularly by a specialist workshop, preferably an authorized BMW Motorrad retailer.
- » The operating and road safety of the vehicle remains unchanged.
- » The best-possible value retention of the vehicle is ensured.

Operation

Steering and ignition lock	58	Shiftpoint light	81
Ignition with Keyless Ride.....	60	Anti-theft alarm system (DWA).....	82
Emergency on/off switch (kill switch).....	64	Tire Pressure Monitor (TPM)	84
Lights.....	64	Heated handlebar grips	84
Hazard warning flashers.....	66	Rider and passenger seats.....	85
Turn indicators.....	66		
Antilock Braking System (ABS)	67		
Traction control (ASC/DTC).....	69		
Electronic chassis and suspension adjustment (D-ESA)	70		
Riding mode	73		
PRO riding mode	75		
Cruise-control system	76		
Hill Start Control (Hill Start Con- trol)	79		

Steering and ignition lock

Vehicle keys

You are provided with 2 ignition keys.

Should you lose your keys, refer to the information regarding the electronic immobilizer (EWS) (► 59).

A single key fits the steering and ignition lock, the fuel filler cap and the seat lock.

The cases and the Topcase can also be ordered with locks for the same key on request. Please contact an authorized workshop for this purpose, preferably an authorized BMW Motorrad retailer.

Locking handlebars

- Turn handlebars to left.



- Turn key to position **1** while moving handlebars slightly.
 - » Ignition, lights and all electrical circuits switched off.
 - » Handlebars are locked.
 - » Key can now be removed.

Switching on ignition



- Insert the motorcycle key into the steering and ignition lock. Turn the key to position **1**.
 - » Parking light and all function circuits are switched on.
 - with LED additional headlight^{OA}
 - » LED additional headlights are switched on.<
 - » Pre-Ride-Check is carried out. (► 128)
 - » ABS self-diagnosis is performed. (► 128)
 - » ASC/DTC self-diagnosis is performed. (► 130)

Switch off ignition

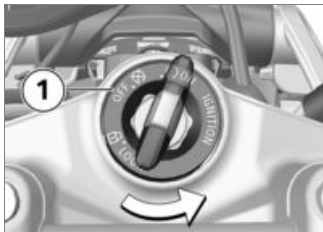

- Turn key to position **1**.
 - » After the ignition is switched off, the instrument cluster remains switched on for a short period of time and indicates possibly present fault codes.
 - » Handlebars not locked.
 - » Electrically powered accessories remain operational for a limited period of time.
 - » Battery can be recharged via onboard socket.
 - » Key can now be removed.

- with LED additional headlight^{OA}
- The supplementary LED headlights switch off shortly after the ignition is switched off.<

EWS Electronic immobilizer

The motorcycle's electronic circuitry monitors the data stored in the ignition key through a ring antenna incorporated in the steering and ignition lock. The engine management system does not enable engine starting until this key has been recognized as "authorized" for your motorcycle.



NOTICE

A further key attached to the same ring as the ignition key used to start the engine could "irritate" the electronics, in which case the enabling signal for starting is not issued.

Always store further vehicle keys separately from the ignition key. ◀

If you lose a motorcycle key, you can have it disabled by your authorized BMW Motorrad Retailer. When having a key disabled you should also bring all of the motorcycle's remaining keys with you. The engine can no longer be started using a disabled key; however, a disabled key can be enabled again.

Emergency and spare keys are only available through an authorized BMW Motorrad retailer. The keys are part of an integrated security system, so the retailer is under an obligation to check the legitimacy of all applications for replacement/extra keys.

Ignition with Keyless Ride

– with Keyless Ride^{OE}

Vehicle keys

NOTICE

The indicator light for the radio-operated key flashes as long as the radio-operated key is being searched for.

If the radio-operated key or the emergency key is detected, it goes out.

If the radio-operated key or the emergency key is not detected, it lights up briefly. ◀

You are provided with one radio-operated key and one emergency key. Should you lose your keys, refer to the information regarding the electronic immobilizer (EWS) (▶ 59).

The ignition, tank filler cap and anti-theft alarm system are con-

trolled with the radio-operated key. The seat lock, Topcase and case can be operated manually.

NOTICE

When the range of the radio key is exceeded (e.g. in case or Topcase), the motorcycle cannot be started.

If the radio-operated key continues to be missing, the ignition is switched off after approx. 1.5 minutes to protect the battery charge.

It is advisable to carry the radio-operated key directly on your person (e.g. in a jacket pocket) and to also carry the emergency key as an alternative. ◀



Range of Keyless Ride radio-operated key

Approx. 3.3 ft (Approx. 1 m)

Locking the steering lock Requirement

Handlebars are turned to the left. Key remote is within reception range.

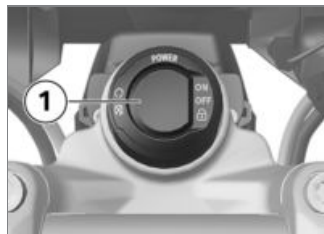

- Press and hold button **1**.
 - » Steering lock audibly locks.
 - » Ignition, lights and all electrical circuits switched off.
- To unlock the steering lock, briefly press button **1**.

Switching on ignition

Requirement

Key remote is within reception range.

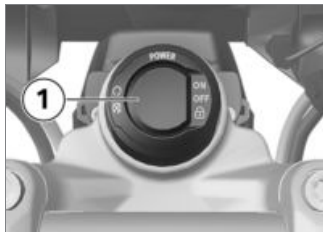

- The steering lock can be unlocked by switching on the ignition.

Steering lock is locked:

- Press and hold button **1**.
 - » Steering lock is unlocked.
 - » Parking light and all function circuits are switched on.

- with LED additional headlight^{OA}
 - » LED additional headlights are switched on.<
 - » Pre-Ride-Check is carried out. (▶▶ 128)
 - » ABS self-diagnosis is performed. (▶▶ 128)
 - » ASC/DTC self-diagnosis is performed. (▶▶ 130)

Steering lock is unlocked:

- Press button **1** briefly.
 - » Parking light and all function circuits are switched on.
- with LED additional headlight^{OA}
 - » LED additional headlights are switched on.<
 - » Pre-Ride-Check is carried out. (▶▶ 128)
 - » ABS self-diagnosis is performed. (▶▶ 128)
 - » ASC/DTC self-diagnosis is performed. (▶▶ 130)

Switch off ignition

Requirement

Key remote is within reception range.



- The steering lock can be locked by switching off the ignition.

Switch off the ignition and lock the steering lock:

- Turn handlebars to left.
- Press and hold button **1**.
 - » Light is switched off.
 - » Steering lock is locked.

Switch off the ignition and do not lock the steering lock:

- Press button **1** briefly.
- » Light is switched off.
- » Steering lock is not locked.
- Locking the steering lock (▣▣▣▣▶ 60).

EWS Electronic immobilizer

The motorcycle's electronic circuitry monitors the data stored in the radio-operated key through a ring antenna in the radio-operated lock. The engine management system does not enable engine starting until the radio-operated key has been recognized as "authorized" for your motorcycle.



NOTICE

An additional key attached to the same ring as the radio-operated key used to start the engine could "irritate" the electronics, in

which case the enabling signal for starting is not issued. Always store further vehicle keys separately from the radio-operated key.◀

If you lose a radio-operated key, you can have it disabled by your authorized BMW Motorrad retailer. When having a key disabled you should also bring all of the motorcycle's remaining keys with you.

The engine can no longer be started using a disabled radio-operated key; however, a disabled radio-operated key can be enabled again.

Emergency and spare keys are only available through an authorized BMW Motorrad retailer. As the radio-operated keys are part of an integrated security system, the retailer is under an obligation to check your legitimacy.

If radio key is lost



NOTICE

Should you lose your keys, refer to the information regarding the electronic immobilizer (EWS). Should you lose the radio-operated key during a trip, the vehicle can be started using the emergency key.◀

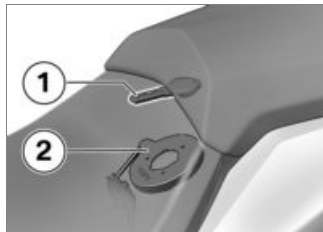

- Insert emergency key **1** in slot between driver's seat and passenger seat so that emergency key is positioned over antenna **2**.



Period in which the engine must be started. Then unlocking must be repeated.

30 s

- » Pre-Ride-Check is carried out.
- Emergency key was detected.
- Engine can be started.
- Emergency key can be removed.
- Start the engine (➡ 127).

Replacing the battery of the key fob transmitter

If the radio key does not respond when a button is pressed for a short or long time:

- The battery for the key remote is not charged to full capacity.



Key remote battery low. Limited central locking function. Change battery.

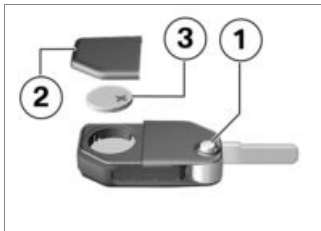

- Press button **1**.
- » Key bit folds open.
- Press battery cover **2** upward.
- Remove battery **3**.
- Dispose of the old battery in accordance with legal regulations. Do not dispose of the battery in the household waste.



ATTENTION

Unsuitable or improperly inserted batteries

Component damage

- Use a battery compliant with the manufacturer's specifications.

- When inserting the battery, make sure that the polarity is correct. ◀
- Insert the new battery with the positive terminal up.



Battery type

For Keyless Ride radio-operated key

CR 2032

- Install battery cover **2**.
- » Red LED in instrument panel flashes.
- » The key fob transmitter is working again.

Emergency on/off switch (kill switch)



- 1** Emergency on/off switch (kill switch)



WARNING

Operation of the emergency ON/OFF switch when riding

Danger of falling due to blocking of rear wheel

- Do not operate the emergency ON/OFF switch when riding. ◀

The engine can be switched off easily and quickly using the emergency on/off switch.

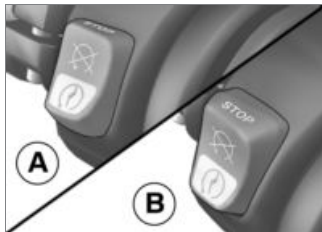

- A** Engine is switched off
B Operating position

Lights

Low-beam headlight and parking lights

The parking lights come on automatically when the ignition is switched on.



NOTICE

The parking lights are a strain on the battery. Do not leave the ignition switched on longer than absolutely necessary. ◀

The low-beam headlight switches on automatically when the engine is started.

High-beam headlight and headlight flasher

- Switching on ignition (➡ 58).



- Press switch **1** toward front to switch on high beam.

- Pull switch **1** toward rear to actuate headlight flasher.

Headlight courtesy delay feature

- Switch off ignition.



- Immediately after turning off the ignition, pull switch **1** back and hold until the headlight courtesy delay feature turns on.
 - » The vehicle lights light up for one minute and then turn off automatically.
- This can be used after parking the vehicle in order to illu-

minate the path to the house door, for instance.

Parking lights

- Switch off ignition (☞ 59).



- Immediately after switching off the ignition, push button **1** to left and hold it until the parking lamps come on.
- Switch ignition on and then off again to switch off parking light.

Additional headlight

– with LED additional headlight^{OA}

Requirement

The low beam must be switched on.

NOTICE

The auxiliary headlights are approved for use as fog lights and may only be used in poor weather conditions. Comply with the country-specific road traffic regulations.◀

- Start the engine (☞ 127).



- Press button **1** to switch on the additional headlights.



The indicator light for the additional headlights lights up.

- Press button **1** again to switch off the additional headlights.

Hazard warning flashers

Operating hazard warning flashers

- Switching on ignition (▶▶▶ 58).



NOTICE

The hazard warning flashers place a strain on the battery. Do not use the hazard warning flashers for longer than absolutely necessary. ◀



- Press button **1** to switch on the hazard warning lights system.
- » Ignition can be switched off.
- To switch off the hazard warning lights system, turn on the ignition, as required, and press button **1** once again.

Turn indicators

Operating turn signals

- Switching on ignition (▶▶▶ 58).



- Press button **1** to left to switch on left-side turn signals.
- Press button **1** to right to switch on right-side turn signals.
- Push the button **1** into the center position to switch off the turn signal.

Comfort turn signals



When button **1** is pressed to the right or left, the turn signal automatically turns off under the following conditions:

- Speed is under 18 mph (30 km/h): after traveling a distance of 165 ft (50 m).
- Speed is between 18 mph and 60 mph (30 km/h and 100 km/h): after covering a particular distance depending on the speed or when accelerating.

- Speed is above 60 mph (100 km/h): after turn signal flashes five times.

When button **1** is pressed and held slightly longer to the right or left, the turn signals will only turn off automatically after reaching the distance depending on the speed.

Antilock Braking System (ABS)

Deactivating ABS function

- Switching on ignition (☞ 58).



The ABS function can also be deactivated while driving.◀



- Press and hold button **1** until the ABS indicator and warning light changes its display behavior.

Immediately after pressing the button **1**, the current ASC/DTC system status and ABS system status ON are displayed.

- » First, the ASC indicator and warning light changes its behavior. Press and hold button **1** until the ABS indicator and warning light reacts. In this case, the ASC/DTC setting does not change.



ABS indicator and warning light lights up.

Possible ABS system status OFF! is displayed.

- Release button **1** after changeover of the ABS system status.

ASC/DC system status remains unchanged and new ABS system status OFF! is displayed for a short time.



ABS indicator and warning light remains illuminated.

- » The ABS function is switched off.
- » The integral function is active again.
- without riding modes Pro^{OE}
 - » The Hill Start Control function is active again.<
- with riding modes Pro^{OE}
 - » The Hill Start Control Pro function is active again.<

- with riding modes Pro^{OE}
 - » The Dynamic Brake Control function is switched off when the ABS function is switched off.<
- More information about brake systems with BMW Motorrad Integral ABS can be found in the "Technology in detail" chapter:
 - » Partially integral brake (▮▮▮▶ 142)
 - » Hill Start Control function (▮▮▮▶ 153)
- with riding modes Pro^{OE}
 - » Dynamic Brake Control function (▮▮▮▶ 149)<

Switch on ABS function



- Press and hold button **1** until the ABS indicator and warning light changes its display behavior.

Immediately after pressing the button **1**, the current ASC/DC system status and ABS system status OFF! are displayed.



ABS indicator and warning light goes out, and begins to flash if self-diagnosis has not been completed.

Possible ABS system status ON is displayed.

- Release button **1** after changeover of the ABS system status.

 ABS indicator and warning light remains off or continues to flash.

ASC/DTC system status remains unchanged and new ABS system status ON is displayed for a short time.

- » The ABS function is switched on.
- As an alternative, the ignition can also be turned off and then on again.

 If the ABS indicator and warning light lights up after switching the ignition off and on and then continuing driving above the minimum speed, an ABS fault has occurred.

min 6 mph (min 10 km/h)

- with riding modes Pro^{OE}
- As an alternative, the ignition can also be turned off and then on again.◀

Traction control (ASC/DTC)

Switching the ASC/DTC function off

- Switching on ignition (▶▶▶ 58).

NOTICE

The ASC/DTC function can also be deactivated while riding.◀



- Press and hold button **1** until the ASC/DTC indicator and warning light changes its display behavior.

Immediately after pressing the button **1**, the ASC/DTC system status ON and current ABS system status are displayed.

 ASC/DTC indicator and warning light lights up.

Possible ASC/DTC system status OFF! is displayed.

- Release button **1** after the ASC/DTC system status switches.

The new ASC/DTC system status OFF! is displayed for a short time. The ABS system status remains unchanged.

 ASC/DTC indicator and warning light remains illuminated.

» The ASC/DTC function is switched off.

Switching the ASC/DTC function on



• Press and hold button **1** until the ASC/DTC indicator and

warning light changes its display behavior.

Immediately after pressing the button **1**, the ASC/DTC system status OFF! and current ABS system status are displayed.

 ASC/DTC indicator and warning light goes out; it begins to flash if self-diagnosis has not been completed.

Possible ASC system status ON is displayed.

• Release button **1** after changeover of the status.

 ASC indicator and warning light remains off or continues to flash.

Possible ASC/DTC system status ON is displayed.

» The ASC/DTC function is switched on.

– without riding modes Pro^{OE}

• Alternatively, turn the ignition off and on again.<

– with riding modes Pro^{OE}

• If the coding plug is not installed, the ignition can also be switched off and then on again as an alternative.

• More information about traction control (ASC/DTC) can be found in the "Technology in detail" chapter:

» How does traction control work? (➡ 145)

Electronic chassis and suspension adjustment (D-ESA)

– with Dynamic ESA^{OE}

Dynamic ESA adjustment options

The Dynamic ESA electronic chassis setting can automatically adapt your motorcycle to the load. If the spring setting is set to **Auto**, the rider does not have to worry about adjusting the load.

More information about Dynamic ESA can be found in the "Technology in detail" chapter (➔ 147).

Available damping modes

- For road use: Road and Dynamic

Available load settings

- Fixed minimum spring setting: Min
- Active riding position compensation with automatic spring setting: Auto
- Fixed maximum spring setting: Max



BMW Motorrad recommends the **Auto** chassis and suspension adjustment. ◀

Display suspension setting

- Switching on ignition (➔ 58).



- Press button **1** briefly to display the current setting.

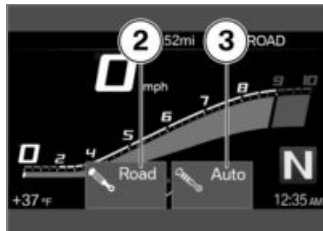

Immediately after pressing the button **1**, the chassis and suspension adjustment options for damping **2** and spring setting **3** are displayed.

» The display automatically disappears again after a short time.

Setting suspension compliance

- Switching on ignition (➔ 58).



- Press button **1** briefly to display current setting.

To set the damping rate:

- Briefly press button **1** repeatedly until the desired setting is displayed.



NOTICE

The damping cannot be adjusted while the motorcycle is being ridden. ◀

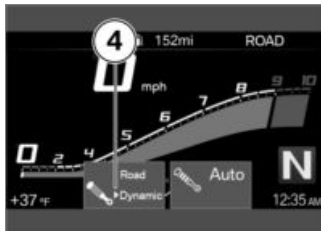

The selection arrow **4** is displayed.

- » The selection arrow **4** goes away after the changeover of the status.

The following settings are available:

- Road: damping for comfortable road travel
- Dynamic: damping for dynamic road travel



To adjust the spring setting:

- Start the engine (▶▶▶ 127).
- Long-press button **1** repeatedly until the desired setting is displayed.



NOTICE

The spring setting cannot be changed while the motorcycle is underway. ◀

The following message is displayed if no adjustments are possible: Load adjust. only avail. when halted.

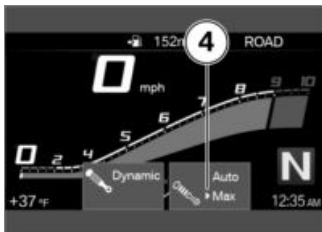

The selection arrow **4** is displayed.

- » The selection arrow **4** goes away after the changeover of the status.

The following settings are available:

- **Min**: Minimum spring setting (only suitable for one-up mode)
- **Auto**: Automatic spring setting (recommended chassis and suspension adjustment)
- **Max**: Maximum spring setting (only suitable for two-up mode)

- » If the button **1** is not pressed for an extended period, the damping action and the spring setting will be adjusted to the displayed settings.

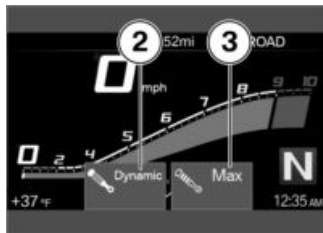

The new chassis and suspension adjustment options for damping **2** and spring setting **3** are displayed for a short period of time.

- At very low temperatures, unload the motorcycles before increasing the spring setting, and have the passenger dismount if necessary.

- » The chassis and suspension adjustment display goes away once the adjustment procedure has been completed.
- » In the loading mode **Auto**, the spring setting is only adjusted after riding off.

Riding mode

Use of the riding modes

BMW Motorrad has developed riding scenarios for your motorcycle from which you can select the one matching your situation:

Series

- **RAIN**: Riding on rain-slicked roads.
- **ROAD**: Riding on dry roads.

– with riding modes Pro^{OE}

With pro riding modes

- **DYNAMIC**: Dynamic riding on dry roads.
- **DYNAMIC PRO**: Dynamic riding on dry roads, taking ac-

count of the settings by the driver.

The optimum interaction between engine characteristics, ABS control, and ASC/DTC control is provided for each of these scenarios.

– with Dynamic ESA^{OE}

The chassis and suspension adjustments can also be adapted in the selected scenario.

More detailed information about the riding modes can be found in the "Technology in detail" chapter (➔ 148).

Select riding mode

- Switching on ignition (➔ 58).



- Press button **1**.



The active riding mode **2** fades into the background and the first selectable riding mode **3** is displayed. The guide **4** shows how many riding modes are available.



- Press button **1** repeatedly until the desired riding mode is shown.

The following riding modes can be selected:

- RAIN: For riding on rain-slicked roads.
- ROAD: For riding on dry roads.

– with riding modes Pro^{OE}

The following riding mode can also be selected:

- DYNAMIC: For dynamic riding on dry roads.
- DYNAMIC PRO: For dynamic riding on dry roads, taking ac-

count of the settings made by the rider.◁

- » When the motorcycle is stationary, the selected riding mode is activated after approx. 2 seconds.
- » The new riding mode is activated during operation under the following conditions:
 - Throttle grip is in idle position.
 - Brake is not engaged.
 - Cruise control is not active.
- » The riding mode selected and its associated engine characteristic, ASC, DTC and Dynamic ESA settings are retained even after the ignition has been switched off.

PRO riding mode

- with riding modes Pro^{OE}

Adjustment options

The PRO riding mode can be individually adjusted.

Setting up the PRO riding mode

- Switching on ignition (▣→ 58).
- Call up menu Settings, Vehicle settings.
 - » The following PRO riding mode can be adjusted:
 - DYNAMIC PRO riding mode
- Select and confirm the riding mode.

Adjust Dynamic Pro

- with riding modes Pro^{OE}
- Setting up the PRO riding mode (▣→ 75).

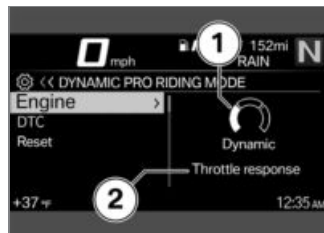

The Engine system is selected. The current setting is displayed as a diagram 1 with system descriptions 2.

- Select and confirm the system.



You can browse through the possible settings **3** and the related descriptions **4**.

- Adjust the system.
 - » The Engine and DTC systems can also be adjusted in the same way.
- The settings can be reset to factory settings:
- Resetting the riding mode settings (➡ 76).

Resetting the riding mode settings

- Setting up the PRO riding mode (➡ 75).

- Select **Reset** and confirm.
 - » The following factory settings apply for **DYNAMIC PRO RIDING MODE**:
 - DTC: **Dynamic**
 - ENGINE: **Dynamic**

Cruise-control system

- with cruise control^{OE}

Display while adjusting (road sign detection not active)



The symbol **1** for the cruise control is displayed in the Pure Ride view and in the upper status line.

Display while adjusting (road sign detection active)



The symbol **1** for the cruise control is displayed in the Pure Ride view and in the upper status line.

Switch on cruise-control system



- Push switch **1** to right.
- » Button **2** is unlocked.

Store speed

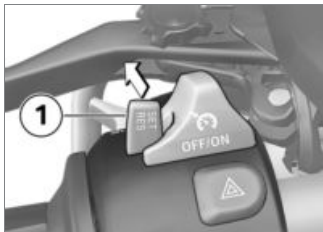

- Short-press button **1** forward.



Adjustment range of
cruise-control system

12...130 mph (20...210 km/h)



Cruise-control system indi-
cator light lights up.

- » The motorcycle maintains your
current cruising speed and the
setting is saved.

Accelerating

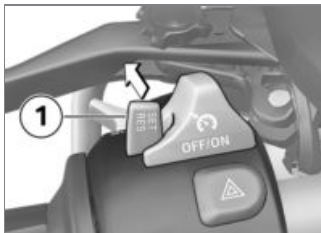

- Short-press button **1** forward.
- » Speed is increased by 1 mph
(1.6 km/h) each time the button
is pressed.

- Press button **1** forward and
hold.
- » The motorcycle accelerates
with infinite variability (no
steps).
- » If button **1** is no longer
pressed, the speed reached is
maintained and saved.

Decreasing speed

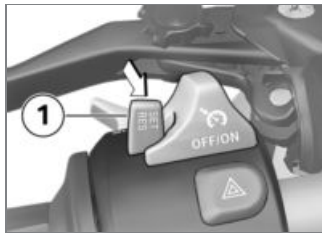

- Briefly press button **1** back-
ward.
- » Speed is reduced by 1 mph
(1.6 km/h) each time the button
is pressed.
- Press button **1** back and hold.

- » The motorcycle decelerates with infinite variability (no steps).
- » If button **1** is no longer pressed, the speed reached is maintained and saved.

Deactivating cruise-control system

- Actuate brakes, clutch or throttle grip (take back throttle beyond back position) to deactivate cruise-control system.

NOTICE

When changing gear using the Pro Gear-shift Assistance function, the cruise-control system is automatically deactivated for safety reasons.◀

NOTICE

With ASC and DTC interventions, the cruise-control system is au-

tomatically deactivated for safety reasons.◀

- » Cruise-control system indicator light goes out.

Resuming former cruising speed

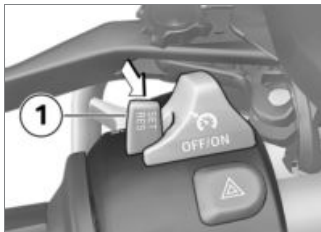

- Briefly push button **1** back to return to the speed saved beforehand.

NOTICE

Opening the throttle does not deactivate the cruise-control system. If you release the throttle grip, the motorcycle will decel-

erate only to the cruising speed saved in memory, even though you might have intended slowing to a lower speed.◀



Cruise-control system indicator light lights up.

Switch off cruise-control system

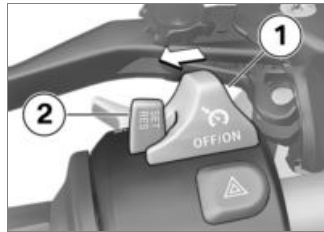

- Push switch **1** to the left.
- » The system is switched off.
- » Button **2** is locked.

Hill Start Control (Hill Start Control)

Display

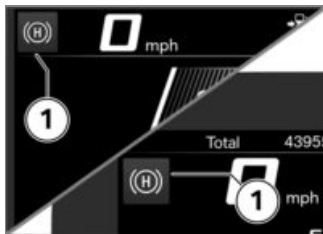

The symbol **1** for the drive-off assistant is displayed in the Pure Ride view and in the upper status line.

Switch Hill Start Control on and off

- Switching on ignition (→ 58).
- Call up menu *Settings, Vehicle settings*.
- Turn *Hill Start Control* on or off.

Using Hill Start Control Requirement

Vehicle at standstill. Hill Start Control is switched on.

ATTENTION

Drive-off assistant failure

Accident hazard

- Manually brake to secure the vehicle. ◀

NOTICE

Hill Start Control is only a convenience system for easier hill-starting and should, therefore, not be confused with a parking brake. ◀

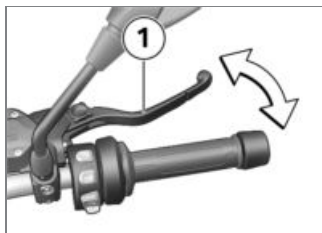

- Apply handbrake lever **1** or footbrake lever firmly and then release again.

 Green stop symbol is displayed.

- » Hill Start Control is activated.
- To switch off the Hill Start Control, activate the handbrake lever **1** or the footbrake lever again.

 Stop symbol disappears.

- Alternatively, drive off in 1st or 2nd gear.

**NOTICE**

Hill Start Control is deactivated automatically when driving off. ◀



The stop symbol disappears after the brake has been released completely.

- » Hill Start Control is deactivated.
- More information about Hill Start Control can be found in the "Technology in detail" chapter:
- » Hill Start Control function (▶▶▶ 153)

Adjust Hill Start Control Pro

– with riding modes Pro^{OE}

- Switching on ignition (▶▶▶ 58).
- Call up menu *Settings, Vehicle settings*.
- Select *Hill Start Control Pro*.

- To turn off Hill Start Control Pro, select *Off*.
 - » Hill Start Control Pro is deactivated.
- To turn on manual Hill Start Control Pro, select *Manual*.
 - » Hill Start Control Pro can be activated by firmly applying the handbrake or footbrake lever.
- To turn on automatic Hill Start Control Pro, select *Auto*.
 - » Hill Start Control Pro can be activated by firmly applying the handbrake or footbrake lever.
 - » When applying the brake for approximately one second after the vehicle has come to a standstill and on a slope with at least a 5% gradient, Hill Start Control Pro is activated automatically.
 - » The selected setting is retained even after the ignition is turned off.

Using Hill Start Control Pro

– with riding modes Pro^{OE}

**ATTENTION**

Drive-off assistant failure

Accident hazard

- Manually brake to secure the vehicle. ◀

**NOTICE**

Hill Start Control Pro is only a comfort system to make starting on hills easier and should therefore not be confused with a parking brake. ◀

**NOTICE**

Hill Start Control Pro drive-off assistant should not be used for gradients of more than 40%. ◀

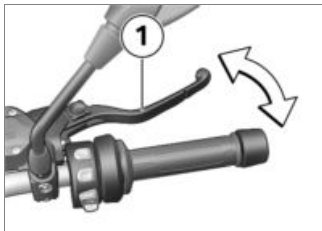

- Apply handbrake lever **1** or footbrake lever firmly and then release again.
- Alternatively, apply the brake for about one second after the vehicle has come to a standstill, with a gradient of at least 5%.

 Green stop symbol is displayed.

- » Hill Start Control Pro is now activated.
- To switch off Hill Start Control Pro, activate the handbrake lever **1** or the footbrake lever again.

NOTICE

If Hill Start Control Pro is deactivated using the brake lever, automatic Hill Start Control is deactivated for the next 4 m. ◀

 Stop symbol disappears.

- Alternatively, drive off in 1st or 2nd gear.

NOTICE

Hill Start Control Pro is deactivated automatically when driving off. ◀

 The stop symbol disappears after the brake has been released completely.

- » Hill Start Control Pro is now deactivated.
- More information about Hill Start Control Pro can be found

in the "Technology in detail" chapter:

- » Hill Start Control function (▶▶▶ 153)

Shiftpoint light

– with Style HP^{OE}

Turning the shiftpoint light on and off

- Call up menu Settings, Vehicle settings.
- Turn Shift light on or off.

Setting shifting flash

- Switch on the Shift light function.
- Call up menu Settings, Vehicle settings, Configuration (via Shift light).
- » The following settings are available:
 - Start speed
 - End speed
 - Brightness

- Flashing freq.. A flashing frequency of 0 Hz corresponds to continuous lighting.
- » Changes to the brightness and the flashing frequency are signaled by the shiftpoint light lighting up or flashing.

Anti-theft alarm system (DWA)

- with anti-theft alarm system (DWA)^{OE}

Activation

- Switching on ignition (➡ 58).
- Adjust DWA (➡ 84).
- Switch off ignition.
- » If DWA is activated, DWA is automatically activated after the ignition is switched off.
- » Activation takes approximately 30 seconds to complete.
- » Turn indicators are illuminated twice.

- » Confirmation tone sounds twice (if programmed).
- » The anti-theft alarm system is active.
- with Keyless Ride^{OE}

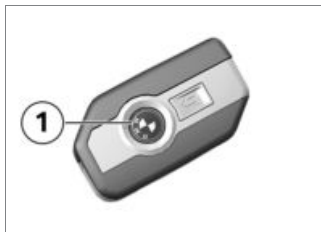

- Switch off ignition.
- Press button **1** on the radio-operated key twice.
- » Activation takes approximately 30 seconds to complete.
- » Turn indicators are illuminated twice.
- » Confirmation tone sounds twice (if programmed).

- » The anti-theft alarm system is active.

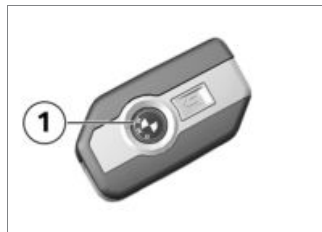

- To deactivate the movement sensor (for example if you are about to transport the motorcycle on a train and the swaying movement of the moving train could trip the alarm), press button **1** on the radio-operated key during the activation phase.
- » Turn signals are illuminated three times.
- » Confirmation tone sounds three times (if programmed).
- » Movement sensor is deactivated.

Alarm signal

The DWA alarm can be set off by:

- Motion sensor
- Switch-on attempt with an unauthorized ignition key.
- Disconnecting the DWA from the motorcycle battery (DWA battery takes over the power supply – alarm tone only, turn indicators do not flash)

If the DWA battery is discharged all functions remain operational; the only difference is that the alarm cannot be set off if the system is disconnected from the motorcycle battery.

The duration of the alarm is approx. 26 seconds. During the alarm, an alarm tone sounds and the turn indicators flash. The type of alarm sound can be set by an authorized BMW Motorrad retailer.

– with Keyless Ride^{OE}

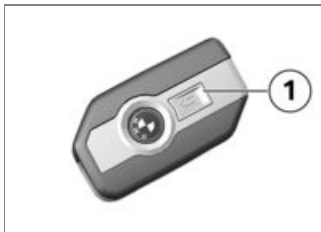

A triggered alarm can be canceled at any time by pressing the key remote button **1** without deactivating the DWA. After the ignition is turned off, both storage compartments are locked after a coastdown time.

If an alarm was activated while the motorcycle was unattended, the rider is notified accordingly by an alarm tone sounding once when the ignition is switched on. The DWA LED then indicates the reason for the alarm for one minute.

Light signals on DWA LED:

- 1 flash: motion sensor 1
- 2 flashes: motion sensor 2
- 3 flashes: ignition turned on with unauthorized ignition key
- 4 flashes: alarm system disconnected from vehicle battery
- 5 flashes: motion sensor 3

DWA Deactivating

- Switch on ignition.
- with Keyless Ride^{OE}

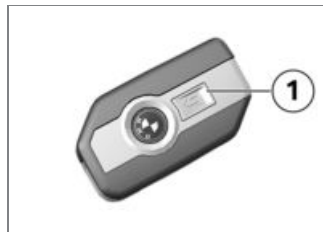

- Briefly press button **1**.
 - » Turn indicators light up once.
 - » Confirmation tone sounds once (if programmed).

» DWA is now switched off.

Adjustment options

Warning signal: Set rising and falling or intermittent alarm tone.

Tilt sensor: Activate the tilt sensor to monitor the tilt of the vehicle. The anti-theft alarm system responds if, for example, if the wheel is stolen or the motorcycle is towed.

NOTICE

Deactivate the tilt sensor when transporting the vehicle to avoid triggering the DWA.◀

Arming tone: Confirmation alarm tone after activating/deactivating the DWA in addition to flashing turn signals.

Arm automatically: Automatic activation of the alarm function when the ignition is turned off.

Adjust DWA

- Switching on ignition (▶▶▶ 58).
 - Call up menu Settings, Vehicle settings, Alarm system.
- » The following adjustments are available:
- Adjust Warning signal
 - Turn Tilt sensor on and off
 - Turn Arming tone on and off
 - Turn Arm automatically on and off

Tire Pressure Monitor (TPM)

– with riding modes Pro^{OE}

Switching the minimum pressure warning on or off

- The minimum pressure of the tires can be freely selected. When the minimum pressure is reached, a minimum pressure warning can be displayed.

- Call up menu Settings, Vehicle settings, TPC/RDC.
- Turn Nom. pressure warning on or off.

Heated handlebar grips

– with heated grips^{OE}

Operating heated grips

NOTICE

The heated grips option can only be activated when the engine is running.◀

NOTICE

The increase in power consumption caused by the heated grips can drain the battery if you are riding at low engine speeds. If the battery is inadequately charged, the heated grips are switched off to ensure starting capability.◀

- Start the engine (➡ 127).

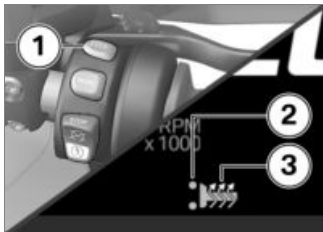

- Press the button **1** repeatedly until the desired heating level **2** is shown in front of the heated grip symbol **3**.

The handlebar grips can be heated at two different levels.



50 % heating output



100 % heating output

- » The 2nd heating level is used for fast heat-up of the grips;

- then the switch should be switched back to the 1st level.
- » If no further changes are made the selected heating level is adopted as the setting.
 - To switch off the heated grips, press the button **1** repeatedly until the heated grip symbol **3** goes out.

Rider and passenger seats

Remove passenger seat

- Park motorcycle, ensuring that support surface is firm and level.

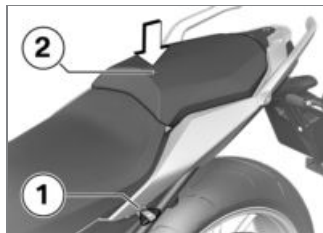

- Press down passenger seat **1** in front area to support unlocking while turning seat lock **2** to left with ignition key and holding.
- Raise passenger seat **2** at front and release ignition key.
- Take off passenger seat **2** and place on a clean surface with upholstered side facing downward.

Installing passenger seat



- First slide passenger seat **1** into mounts in rear area.
- Press down passenger seat **1** firmly at front.
 - » Passenger seat engages with an audible click.

Remove rider's seat

- Remove passenger seat (▮▮▮▮ 85).

Driver's seat is unlocked.

- Take off rider's seat at rear and place on a clean surface with upholstered side facing downward.

Installing driver's seat

- Remove passenger seat (▮▮▮▮ 85).

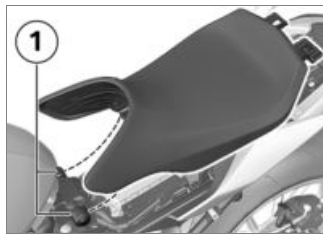

- Press driver's seat into front mounts **1** up to stop and then lay on at rear.

TFT display

General notes.....	88
Principle	89
Pure Ride view.....	96
General settings	97
Bluetooth	98
My vehicle	102
Sport	105
Navigation	107
Media.....	109
Phone	109
Display software version	110
Display license information.....	110

General notes

Warnings



WARNING

Operation of a smartphone while riding or with the engine running

Accident hazard

- Observe the relevant road traffic regulations.
- Do not use while riding (except for applications without operation such as telephony via the hands-free system).◀



WARNING

Distraction from traffic conditions and loss of control

Risk of accident through the use of integrated information systems and communication devices during the journey

- Operate these systems or devices only if the traffic situation allows.
- If necessary, stop and operate the system or devices at a standstill.◀

Connectivity functions

Connectivity functions include media, telephony and navigation. Connectivity functions can be used if the TFT display is connected with a mobile end device and a helmet (►► 99). You can find more information about the Connectivity functions at: bmw-motorrad.com/connectivity



NOTICE

If the fuel tank is between the mobile end device and the TFT display, the Bluetooth connection may be restricted. BMW Motorrad recommends

storing the mobile end device above the fuel tank (e.g. in the jacket pocket).◀



NOTICE

Depending on the mobile end device, the scope of the Connectivity functions may be limited.◀

BMW Motorrad Connected App

With the BMW Motorrad Connected App, you can call up information about the vehicle and usage. To use some features such as navigation, the app must be installed on the mobile end device and be connected to the TFT display. The app starts the route guidance and adapts the navigation.



NOTICE

On some mobile devices, e.g. with operating system iOS, the BMW Motorrad Connected App must be called up before using. ◀

Notice concerning current status

After the editorial deadline, there may be updates to the TFT display. For this reason, some aspects of your motorcycle may vary from the descriptions in this Rider's Manual. Updated information at:

bmw-motorrad.com

Principle Operating elements

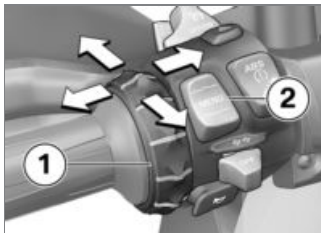

All contents of the display are controlled by the Multi-Controller **1** and the rocker button **MENU 2**.

The following functions are possible depending on the context.

Functions of the Multi-Controller

Turn the Multi-Controller up:

- Move cursor up in lists.
- Make settings.
- Increase volume.

Turn the Multi-Controller down:

- Move cursor down in lists.
- Make settings.
- Reduce volume.

Tilt Multi-Controller to the left:

- Activate the function according to the operating feedback.
- Activate function to the left or back.
- After settings, return to menu view.
- In the menu view: move up one hierarchy level.
- In the My Vehicle menu: leaf to the next menu sheet.

Tilt Multi-Controller to the right:

- Activate the function according to the operating feedback.
- Confirm selection.
- Confirm settings.
- Leaf to the next menu step.

- Scroll to right in lists.
- In the My Vehicle menu: leaf to the next menu sheet.

Rocker button MENU functions

NOTICE

Navigation instructions are displayed as a dialog if the Navigation menu has not been called up. Operation of the MENU rocker button is temporarily restricted.◀

Briefly press the MENU up:

- In the menu view: move up one hierarchy level.
- In the Pure Ride view: change display for rider info status line.

MENU long press up:

- In the menu view: open Pure Ride view.

- In the Pure Ride view: change the operating focus to the navigator.

MENU short press down:

- Change a hierarchy level down.
- No function when lowest hierarchy level is reached.

MENU long press down:

- Return to the last menu, after a menu change has been previously carried out by long press of the rocker button MENU at the top.

Operating instructions in the main menu

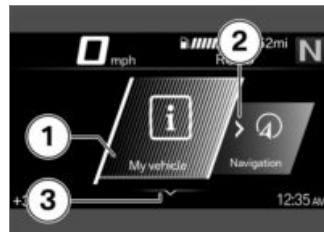

The operating instructions indicate whether and which interactions are possible.

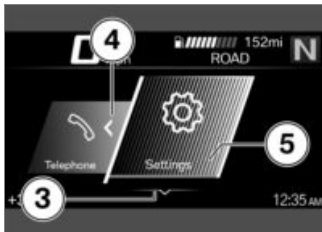

Meaning of the operating instructions:

- Operating instruction **1**: the left end has been reached.
- Operating instruction **2**: you can leaf to the right.
- Operating instruction **3**: you can leaf down.
- Operating instruction **4**: you can leaf to the left.
- Operating instruction **5**: the right end has been reached.

Operating instructions in submenus

In addition to the operating instructions in the main menu, there are additional operating instructions in submenus.

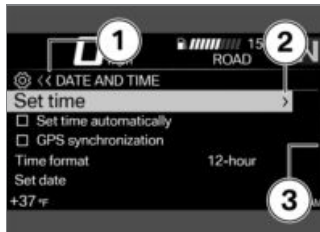

Meaning of the operating instructions:

- Operating instruction **1**: the current display is in a hierarchical menu. One symbol indicates a submenu level. Two symbols indicate two or more submenu levels. The color of the symbol changes depending

on whether it is possible to return to the top.

- Operating instruction **2**: another submenu level can be called up.
- Operating instruction **3**: there are more entries than can be displayed.

Show Pure Ride view

- Long-press the top rocker button MENU.

Switching functions on and off



Some items are preceded by a box. The box indicates whether the function is switched on or off. Action symbols after the menu items illustrate what is switched by briefly tilting the Multi-Controller to the right.

Examples for switching on and off:

- Symbol **1** indicates that the function is switched on.
- Symbol **2** indicates that the function is switched off.

- Symbol **3** indicates that the function can be switched off.
- Symbol **4** indicates that the function can be switched on.

Calling up the menu

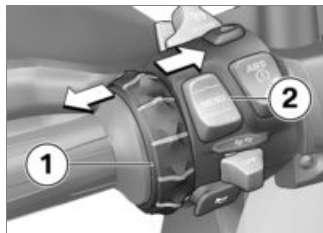

- Show Pure Ride view (▬▬▬▬ 91).
- Briefly press button **2** downward.

The following menus can be called up:

- My vehicle
- Sport
- Navigation
- Media
- Telephone

– Settings

- Press Multi-Controller **1** repeatedly briefly to the right until the desired menu item is marked.
- Briefly press button **2** downward.



NOTICE

The Settings menu can only be called up when stationary.◀

Moving the cursor in lists

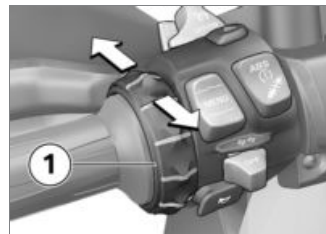

- Calling up the menu (▬▬▬▬ 92).
- To move the cursor down in lists, turn the Multi-Controller **1**

down until the desired entry is marked.

- To move the cursor up in lists, turn the Multi-Controller **1** up until the desired entry is marked.

Confirming the selection

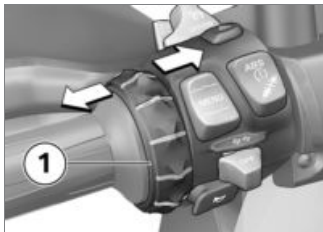

- Select desired entry.
- Multi-Controller **1** short press to right.

Calling up the last menu used

- In the Pure Ride view: rocker button MENU long press down.

- » The last used menu is called up. The last marked entry is selected.

Operating focus change

- with preparation for navigation system^{OE}

When the Navigator is connected, you can switch between the operation of the Navigator and the TFT display.

Changing the operating focus

- with preparation for navigation system^{OE}

- with preparation for navigation system^{OE}

- with navigation system^{OA}

- Fasten navigation system securely (▮▮▮ 198).
- Show Pure Ride view (▮▮▮ 91).
- Long-press the top rocker button MENU.

- » Operating focus changes to the Navigator or the TFT display. The active device is marked in the upper left status line. Operating actions affect the active device until the operating focus is changed again.
- » Operating the navigation system (▮▮▮ 200)

System status displays

The system status is displayed in the lower menu area when a function has been switched on or off.

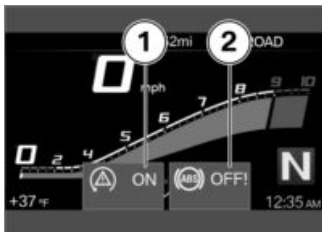

Examples of the meaning of the system statuses:

- System status **1**: ASC/DTC function is switched on.
- System status **2**: ABS function is switched off.

Changing the display for rider info status line

Requirement

The vehicle is at a standstill. The Pure Ride view is displayed.

- Switching on ignition (▶▶▶ 58).
- » All of the information necessary for operating the vehicle on public roads is made avail-

able from the on-board computer (e.g. TRIP **1**) and the travel on-board computer (e.g. TRIP **2**) in the TFT display. The information can be displayed in the upper status line.







- with tire pressure monitor (TPM)^{OE}
- » In addition, information from the Tire Pressure Monitor can be displayed.<
- Select content of rider info. status line (▶▶▶ 95).



- Long press button **1** to display the Pure Ride view.

- Press button **1** briefly to select the value in the upper status line **2**.

The following values can be displayed:

- Odometer Total
- Trip distance 1 TRIP 1
- Trip distance 2 TRIP 2
-  Average consumption 1
-  Average consumption 2
-  Driving time 1
-  Driving time 2
-  Break 1
-  Break 2

 Average speed 1

 Average speed 2

 Tire inflation pressure

 Fuel gage

 Range

Select content of rider info. status line

- Call up menu *Settings, Display, Status line* content.
- Turn on desired displays.
- » It is possible to change between the selected displays in the rider info. status line. If no displays are selected, only the range is shown.

Making settings



- Select desired settings menu and confirm.
- Turn Multi-Controller **1** down until the desired setting is marked.
- If an operating instruction is present, tilt Multi-Controller **1** to the right.
- If no operating instruction is present, tilt Multi-Controller **1** to the left.
- » The setting is saved.

Switch Speed Limit Info on or off

Requirement

Vehicle is connected to a compatible mobile terminal. The BMW Motorrad Connected app is installed on the mobile terminal.

- *Speed Limit Info* displays the currently permitted top speed.
- Go to *Settings, Display* menu.
- Switch *Speed Limit Info* on or off.

Pure Ride view Tachometer

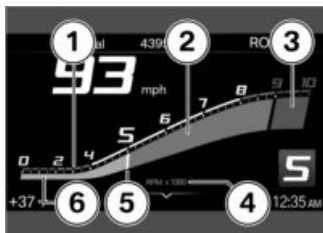

- 1 Scale
- 2 Low engine speed range
- 3 High / red engine speed range
- 4 Needle
- 5 Drag pointer
- 6 Unit for tachometer:
1000 RPM



NOTICE

The red engine speed range changes depending on the coolant temperature:

The colder the engine, the lower the speed at which the red engine speed range begins.

The warmer the engine, the higher the speed at which the red engine speed range begins. When the operating temperature has been reached, the red engine speed range display will no longer change.

The upshift recommendation is adjusted dynamically as well. ◀

Range

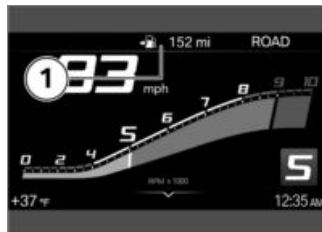

The range **1** indicates how far you can ride with the remaining fuel. This distance is calculated on the basis of average consumption and the quantity of fuel on board.

- When the motorcycle is propped on its side stand the slight angle of inclination means that the sensor cannot register the fuel level correctly. For this reason, the range is only recalculated when the side stand is folded in.

- The range is displayed together with a warning once the fuel reserve is reached.
- After refueling, the range is recalculated if the fuel quantity is greater than the fuel reserve.
- The calculated range is only an approximate figure.

Upshift recommendation



Upshift recommendation **1** signals the economically best point in time for upshifting.

General settings

Adjusting the volume

- Connect the rider's helmet and the passenger helmet (☛ 100).
- Increase volume: turn Multi-Controller up.
- Reduce volume: turn Multi-Controller down.
- Mute: turn Multi-Controller all the way down.

Set date

- Switching on ignition (☛ 58).
- Call up menu **Settings, System settings, Date and time, Set date.**
- Set Day, Month, and Year.
- Confirm setting.

Adjust date format

- Call up menu **Settings, System settings, Date and time, Date format.**
- Select desired setting.
- Confirm setting.

Set clock

- Switching on ignition (☛ 58).
- Call up menu **Settings, System settings, Date and time, Set time.**
- Set Hour and Minute.

Adjust time format

- Call up menu **Settings, System settings, Date and time, Time format.**
- Select desired setting.
- Confirm setting.

Switch GPS synchronization on or off

- with preparation for navigation system^{OE}
- Call up menu **Settings, System settings, Date and time.**
- Turn GPS synchronization on or off.
- » When the corresponding option is activated in the Navigator,

the time is taken from the Navigator.

» Special functions (▶▶▶ 203)

Adjust units of measurement

- Call up menu `Settings, System settings, Units`.

The following units of measurement can be set:

- Distance covered
- Pressure
- Temperature
- Consumption

Adjust language

- Call up menu `Settings, System settings, Language`.

The following languages can be set:

- Chinese
- German
- English
- Spanish
- French

- Italian
- Dutch
- Portuguese
- Russian
- Ukrainian
- Polish
- Turkish

Adjusting brightness

- Call up menu `Settings, Display, Brightness`.
- Adjust brightness.

Reset all settings

- All settings in the `Settings` menu can be reset to the factory settings.
- Call up menu `Settings`.
- Select `Reset all` and confirm.

The settings of the following menus are reset:

- `Vehicle settings`
- `System settings`
- `Connections`
- `Display`

- `Information`

» Existing Bluetooth connections are not deleted.

Bluetooth

Short-range radio technology

The Bluetooth function may not be offered depending on the country of use.

Bluetooth is a short-range radio technology. Bluetooth devices are short-range devices (transmitting with a limited range) on the license-free ISM band (Industrial, Scientific, Medical) between 2.402 GHz and 2.480 GHz. They can be operated anywhere in the world without requiring a license. Although Bluetooth is designed to establish robust links over a short distance, disturbances are possible, as they are with any wireless technology. Links may

be disturbed, interrupted briefly or lost entirely. Especially when several devices are operated in one Bluetooth network, there is no guarantee for smooth operation in every situation.

Possible sources of interference:

- Interference fields due to transmission towers and similar.
- Devices with incorrectly implemented Bluetooth standard.
- By nearby Bluetooth-capable devices.

Pairing

Before two Bluetooth devices can be linked to one another, they must recognize each other. This process of mutual recognition is known as pairing. When two devices have paired they remember each other, so the pairing process is conducted only once, on initial contact.

NOTICE

On some mobile devices, e.g. with operating system iOS, the BMW Motorrad Connected App must be called up before using. ◀

During the pairing process, the TFT display searches for other Bluetooth-compatible devices within its reception range. The conditions that have to be satisfied before the audio system can recognize another device are as follows:

- The Bluetooth function of the device must be activated
- The device must be "visible" to others
- The device must support the A2DP profile
- Other Bluetooth-capable devices must be OFF (e.g. mobile phones and navigation systems).

Please consult the operating instructions for your communication system.

Perform pairing

- Call up menu `Settings, Connections`.
- » Bluetooth connections can be established, managed, and deleted in the `CONNECTIONS` menu. The following Bluetooth connections are displayed:

- Mobile device
- Rider's helmet
- Passeng. helmet

The connection status for mobile end devices is displayed.

Connect mobile end device

- Perform pairing (☞ 99).
- Activate the Bluetooth function of the mobile end device (see operating instructions for the mobile end device).

- Select `Mobile device` and confirm.
- Select `Pair new mobile device` and confirm.

Mobile end devices are searched for.

 During the pairing, the Bluetooth symbol flashes in the lower status line.

Visible mobile end devices are displayed.

- Select the mobile end device and confirm.
- Observe the instructions for the mobile end device.
- Confirm that the codes match.
- » The connection is established and the connection status is updated.
- » If the connection cannot be established, the troubleshooting chart in the "Technical data" chapter may provide assistance. (►►► 213)

- » Depending on the mobile end device, telephone data is transferred to the vehicle automatically.
- » Telephone data (►►► 110)
- » If the phone book is not displayed, the troubleshooting chart in the "Technical data" chapter may provide assistance. (►►► 214)
- » If the Bluetooth connection does not work as expected, the troubleshooting chart in the "Technical data" chapter may provide assistance. (►►► 213)

Connect the rider's helmet and the passenger helmet

- Perform pairing (►►► 99).
- Select `Rider's helmet` or `Passeng. helmet` and confirm.
- Show the communication system of the helmet.

- Select `PAIR NEW RIDER'S HELMET` or `PAIR NEW PASS. HELMET` and confirm.

Helmets are searched for.

 During the pairing, the Bluetooth symbol flashes in the lower status line.

Visible helmets are displayed.

- Select helmet and confirm.
- » The connection is established and the connection status is updated.
- » If the connection cannot be established, the troubleshooting chart in the "Technical data" chapter may provide assistance. (►►► 213)
- » If the Bluetooth connection does not work as expected, the troubleshooting chart in the "Technical data" chapter may provide assistance. (►►► 213)

Delete connections

- Call up menu Settings, Connections.
- Select Delete connections.
- To delete an individual connection, select the connection and confirm.
- To delete all connections, select Delete all connections and confirm.

My vehicle

Start screen

- 1 Check Control display
Display (➡ 28)
- 2 Coolant temperature
(➡ 43)
- 3 Range (➡ 96)
- 4 Total mileage
- 5 Service display (➡ 54)
- 6 Rear tire pressure (➡ 44)
- 7 Vehicle voltage (➡ 183)
- 8 Engine oil level (➡ 42)
- 9 Front tire pressure (➡ 44)

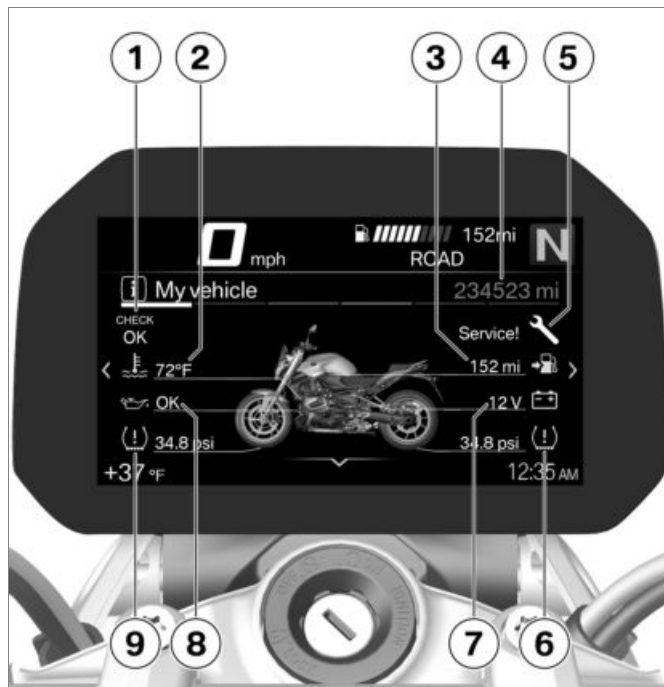

Operating instructions

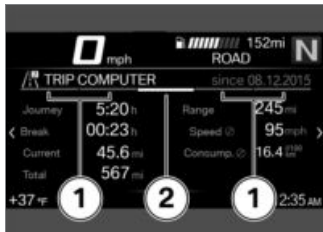

- Operating instruction **1**: tab that shows how far to the left or right you can leaf.
- Operating instruction **2**: tab that shows the position of the current menu screen.

Scroll through menu windows

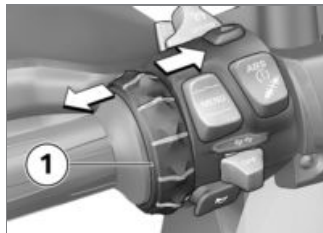

- Call up menu *My vehicle*.
- To scroll to the right, briefly push the Multi-Controller **1** to the right.
- To scroll to the left, briefly push the Multi-Controller **1** to the left.

The "My vehicle" menu contains the following windows:

- MY VEHICLE
- CC messages (if available)
- ONBOARD COMPUTER
- TRIP COMPUTER

- with tire pressure monitor (TPM)^{OE}
- TIRE PRESSURE ◀
- SERVICE REQUIREMENTS
- Further information on the tire pressure and CC messages can be found in the "Displays" chapter.



NOTICE

Check Control messages are dynamically added as additional tabs to the menu screens in the *My Vehicle* menu. ◀

On-board computer and travel on-board computer

The ONBOARD COMPUTER and TRIP COMPUTER menu windows show the vehicle and journey data, e.g. average values.

Call up on-board computer

- Call up menu *My vehicle*.

- Scroll to the right until the ON-BOARD COMPUTER menu window is displayed.

Reset on-board computer

- Call up on-board computer (▣▶ 103).
- Press MENU rocker button down.
- Select `Reset all values` or `Reset individual values` and confirm.

The following values can be reset individually:

- Break
- Journey
- Current (TRIP 1)
- ∅ speed
- ∅ consump.

Call up travel on-board computer

- Call up on-board computer (▣▶ 103).

- Scroll to the right until the TRIP COMPUTER menu window is displayed.

Reset travel on-board computer

- Call up travel on-board computer (▣▶ 104).
- Press MENU rocker button down.
- Select `Automatic reset` or `Reset all` and confirm.
- » If `Automatic reset` has been selected, the travel on-board computer is automatically reset if at least 6 hours have passed since the ignition was turned off and the date has changed.

Service requirement

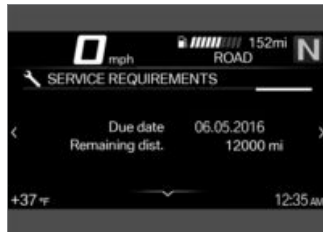

If the time remaining until the next service is less than a month, or if the next service is due within 700 miles (1000 km), a white CC message is displayed.

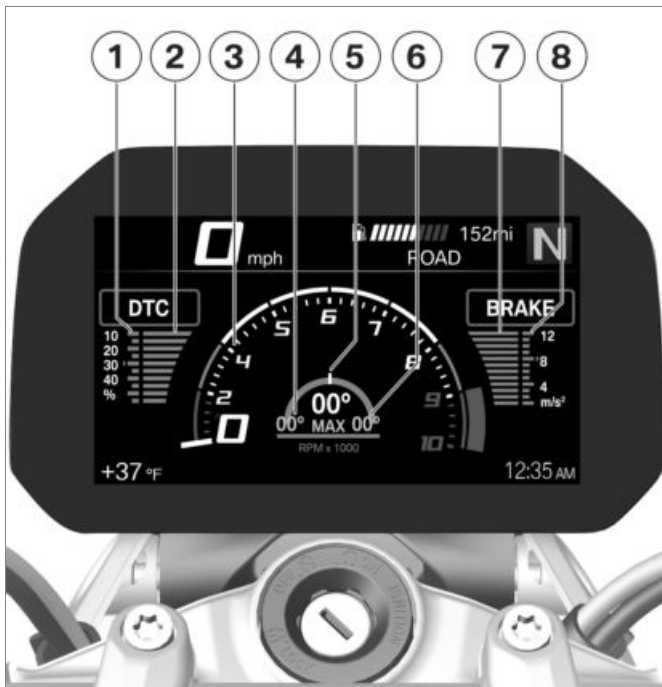

Sport

– with Style HP^{OE}

Sport overview

- 1 Maximum DTC torque reduction
- 2 Current DTC torque reduction
- 3 Tachometer
- 4 Maximum angle when tilted to left
- 5 Current angle of inclination during cornering for left and right
- 6 Maximum angle when tilted to right
- 7 Current deceleration during braking
- 8 Maximum deceleration

Resetting the maximum values

The maximum values for DTC torque reduction, angle of inclination and deceleration are automatically reset after the ignition is switched off.

Navigation

Warnings



Operation of a smartphone while riding or with the engine running

Accident hazard

- Observe the relevant road traffic regulations.
- Do not use while riding (except for applications without operation such as telephony via the hands-free system).◀



Distraction from traffic conditions and loss of control

Risk of accident through the use of integrated information systems and communication devices during the journey

- Operate these systems or devices only if the traffic situation allows.
- If necessary, stop and operate the system or devices at a standstill.◀

Prerequisite

The vehicle is connected to a compatible mobile end device.

The BMW Motorrad Connected App is installed on the mobile end device.

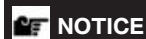

On some mobile devices, e.g. with operating system iOS, the BMW Motorrad Connected App must be called up before using.◀

Enter destination address

- Connect mobile end device (▣▣▣ 99).

- Call up the BMW Motorrad Connected app and start the route guidance.
- Call up menu **Navigation** in the TFT display.
 - » Active route guidance is displayed.
 - » If the active route guidance is not displayed, the troubleshooting chart in the "Technical data" chapter may provide assistance. (▣▣▣ 214)

Select destination from most recent destinations

- Call up menu **Navigation**, **Recent destinations**.
- Select destination and confirm.
- Select **Start route guidance**.

Select destination from favorites

- The **FAVORITES** menu shows all destinations that have been saved as a

favorite in the BMW Motorrad Connected app. It is not possible to create new favorites on the TFT display.

- Call up menu *Navigation, Favorites*.
- Select destination and confirm.
- Select *Start guidance*.

Enter special destination

- Special destinations, e.g. landmarks, can be displayed on the map.
- Call up menu *Navigation, POIs*.

The following locations can be selected:

- *At current location*
- *At destination*
- *Along the route*
- Select the area to look for special destinations.

E.g. the following special destination can be selected:

- *Filling station*

- Select special destination and confirm.
- Select *Start route guidance* and confirm.

Define route criteria

- Call up menu *Navigation, Route criteria*.

The following criteria can be selected:

- *Route type*
- *Avoid*
- Select desired *Route type*.
- Turn desired *Avoid* on or off.

The number of enabled avoidances is displayed in brackets.

End route guidance

- Call up menu *Navigation, Active route guidance*.
- Select *End route guidance* and confirm.

Switch spoken directions on or off

- Connect the rider's helmet and the passenger helmet (100).
- The navigation can be read out by a computer voice. To do this, the *Spoken instructions* must be turned on.
- Call up menu *Navigation, Active route guidance*.
- Turn *Spoken instructions* on or off.

Repeat last spoken directions

- Call up menu *Navigation, Active route guidance*.
- Select *Current spoken instruct.* and confirm.

Media

Prerequisite

The vehicle is connected to a compatible mobile end device and a compatible helmet.

Control music playback

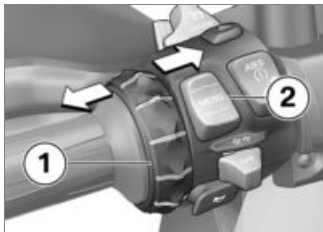

- Call up menu **Media**.

NOTICE

BMW Motorrad recommends setting the volume for media and conversations via mobile end devices to the maximum before starting a journey. ◀

- Adjusting the volume (▮▮▮▮▶ 97).
- Next title: Tilt the Multi-Controller **1** briefly to the right.
- Last title or start of current title: Tilt the Multi-Controller **1** briefly to the left.
- Fast forward: Tilt and hold the Multi-Controller **1** to the right.
- Fast rewind: Tilt and hold the Multi-Controller **1** to the left.
- Call up context menu: Press button **2** down.

NOTICE

Depending on the mobile end device, the scope of the Connectivity functions may be limited. ◀

- » The following functions can be used in the context menu:
 - Start playback or Pause playback.
 - For search and playback, select the category **Now playing**, **All artists**, **All albums**, or **All tracks**.

- Select **Playlists**.

In the **Audio options** submenu you can adjust the following settings:

- Turn **Shuffle** on or off.
- **Repeat**: Select **Off**, **One** (current track), or **All**.

Phone

Prerequisite

The vehicle is connected to a compatible mobile end device and a compatible helmet.

Make a phone call

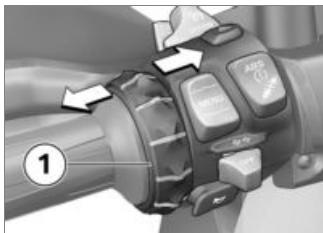

- Call up menu Telephone.
- Accept telephone call: Tilt the Multi-Controller **1** to the right.
- Reject telephone call: Tilt the Multi-Controller **1** to the left.
- End telephone call: Tilt the Multi-Controller **1** to the left.

Mute

The microphone in the helmet can be muted during active conversations.

Conversations with multiple users

A second telephone call can be accepted during a conversation. The first conversation will be put on hold. The number of active telephone calls is displayed in the Telephone menu. It is possible to switch between two conversations.

Telephone data

Depending on the mobile end device, telephone data is transferred to the vehicle automatically after pairing (►► 99).

Phone book: List of contacts saved in the mobile end device

Call list: List of telephone calls with the mobile end device

Favorites: List of favorites saved in the mobile end device

Display software version

- Call up menu Settings, Information, Software version.

Display license information

- Call up menu Settings, Information, Licenses.

Setting

Mirrors	112
Headlight	113
Clutch	114
Gearshift lever	115
Brakes	116
Footrests	118
Spring preload	119
Damping	120

Mirrors

Adjusting mirrors



- Move mirror to the desired position by turning it.

Adjust mirror arm

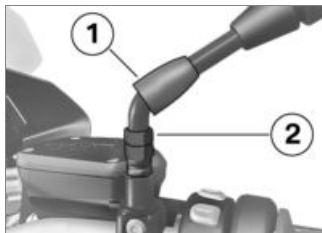

- Slide protective cap **1** up over screw connection on mirror arm.
- Loosen the nut **2**.
- Turn mirror arm into desired position.
- Tighten the nut to the specified torque while holding the mirror arm to ensure that it does not move out of position.



Mirror (locknut) on adapter

16 lb/ft (22 Nm) (Left-hand thread)

- Slide protective cap **1** over screw fitting.

Adjusting mirrors

- with Option 719 Milled Parts Set Classic^{OE}
- or
- with Option 719 Milled Parts Set Storm^{OE}
- or
- with HP machined-parts package^{OE}



NOTICE

To adjust the mirror arm, a small and a large angle screwdriver are included with the vehicle. ◀

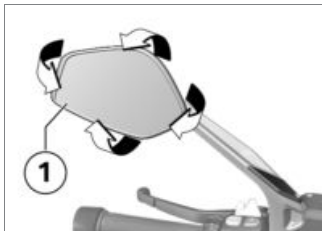

- Move mirror **1** into desired position by turning it.

Adjusting mirror arm

- with Option 719 Milled Parts Set Classic^{OE}
- or
- with Option 719 Milled Parts Set Storm^{OE}
- or
- with HP machined-parts package^{OE}

NOTICE

To adjust the mirror arm, a small and a large angle screwdriver are included with the vehicle. ◀

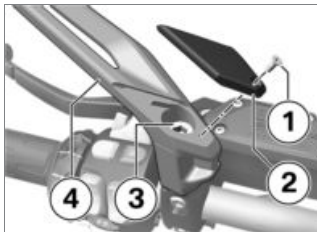

- Remove screw **1** and remove cover **2**.
- Loosen adjusting screw **3** and turn mirror arm **4** into the desired position.
- Tighten adjusting screw **3**, holding the mirror arm while doing so.
- Affix cover **2** and install screw **1**.

	Mirror on handlebars
18 lb/ft (25 Nm)	

Headlight

Headlight range and spring setting

The headlight range generally remains constant due to the adjustment of the spring setting to the loading state.

Only with a very heavy payload can adjustment of the spring setting be insufficient. If that is the case, the headlight range must be adapted to the weight.

NOTICE

If there are doubts as to the correct headlight range, have the adjustment checked by a specialized workshop, preferably by

an authorized BMW Motorrad retailer.◀

Headlight range adjustment

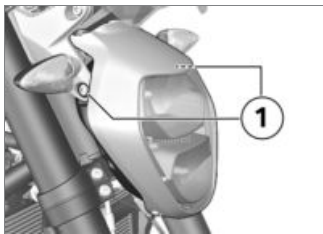

When the spring setting is no longer able to maintain the correct beam height to avoid blinding oncoming traffic owing to high vehicle payloads:

- Loosen screws **1** using the onboard toolkit.

NOTICE

Do not place motorcycle on center stand or side stand.◀

- Swing headlight downward somewhat (depending on payload) to lower headlight light.

If the motorcycle is ridden again with lower payload:

- Have the headlight default setting readjusted by an authorized workshop, preferably an authorized BMW Motorrad retailer.
- Tighten screws **1** using the onboard toolkit.

Clutch

Adjusting clutch lever

WARNING

Adjusting the clutch lever while driving

Accident hazard

- Adjust the clutch lever when the motorcycle is stationary.◀

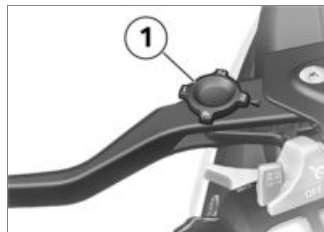

- Turn the adjustment wheel **1** into the desired position.

NOTICE

The adjustment wheel can be turned more easily if you press the clutch lever forward when doing so.◀

- » Four settings are available:
 - Position 1: smallest distance between handlebar grip and clutch lever
 - Position 4: largest distance between handlebar grip and clutch lever

– with Option 719 Milled Parts Set Classic^{OE}

or

– with Option 719 Milled Parts Set Storm^{OE}

or

– with HP machined-parts package^{OE}

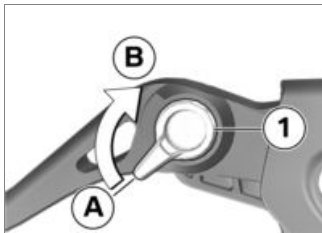

- Turn the adjustment lever **1** to the desired position.
 - » Adjustment options:
 - From position **A**: smallest distance between handlebar grip and clutch lever.
 - Five steps toward position **B** to increase the distance be-

tween the handlebar grip and the clutch lever.<

Gearshift lever

– with Option 719 Milled Parts Set Classic^{OE}

or

– with Option 719 Milled Parts Set Storm^{OE}

or

– with HP machined-parts package^{OE}

Adjusting gearshift lever foot piece

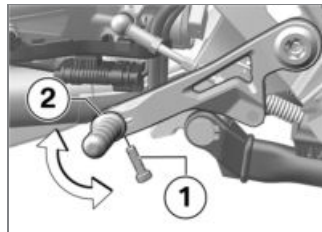

- The distance between the feet and the height of the foot piece **2** can be adjusted by turning the foot piece into different positions.
- Remove screw **1**.

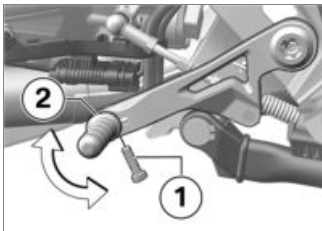

- Clean the thread.
- Turn the foot piece **2** into the desired position.
- Install the **new** screw **1**.



Foot piece to gearshift lever

Thread-locking compound:
micro-encapsulated

7 lb/ft (10 Nm)

Brakes

Adjust brake lever



WARNING

Adjusting the brake lever while driving

Accident hazard

- Only adjust the brake lever when the motorcycle is stationary. ◀

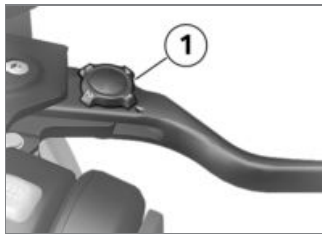

- Turn the adjustment wheel **1** into the desired position.



NOTICE

The adjustment wheel can be turned more easily if you press the handbrake lever forward when doing so. ◀

- » Four settings are available:
- **Position 1:** smallest distance between handlebar grip and brake lever
 - **Position 4:** largest distance between handlebar grip and brake lever

– with Option 719 Milled Parts Set Classic^{OE}

or

– with Option 719 Milled Parts Set Storm^{OE}

or

– with HP machined-parts package^{OE}

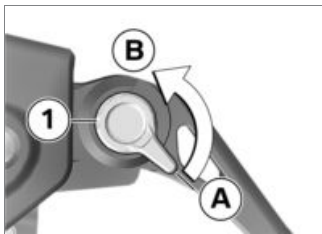

- Turn the adjustment lever **1** to the desired position.
 - » Adjustment options:
 - From position **A**: smallest distance between handlebar grip and handbrake lever.
 - Five steps toward position **B** to increase the distance be-

tween the handlebar grip and the handbrake lever.<

Adjusting the footbrake lever foot piece

– with Option 719 Milled Parts Set Classic^{OE}

or

– with Option 719 Milled Parts Set Storm^{OE}

or

– with HP machined-parts package^{OE}

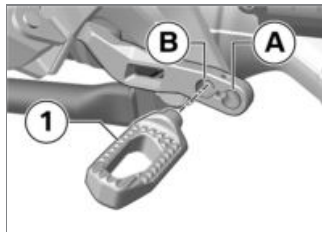

- The distance between the feet and the height of the foot piece **1** can be adjusted by

turning them by 180° and installing them in position **A** or **B**.

- Remove screw **1**.

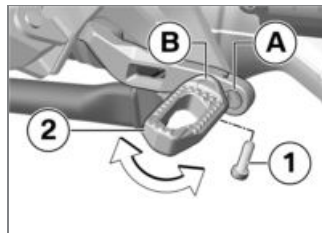

- Clean the thread.
- Install the foot piece **2** in the desired position **A** or **B**.
- Turn the foot piece **2** into the desired position.
- Install the **new** screw **1**.



Foot piece on footbrake lever

Thread-locking compound: micro-encapsulated



Foot piece on footbrake lever

7 lb/ft (10 Nm)

Footrests

– with Option 719 Milled Parts Set Classic^{OE}

or

– with Option 719 Milled Parts Set Storm^{OE}

or

– with HP machined-parts package^{OE}

Adjust footrests

- The footrest is adjusted the same way when moving it right or left.
- The position of the footrest must be set equally on the right and left.

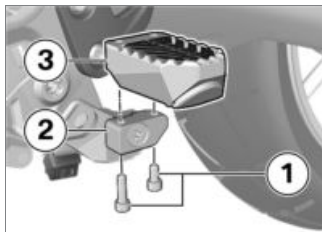

- Remove screws **1**.
- Remove the footrest **3** from the clamping block **2**.

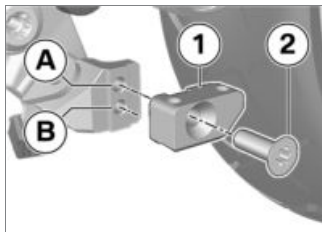

- Remove screw **2**.
- Remove clamping block **1**.

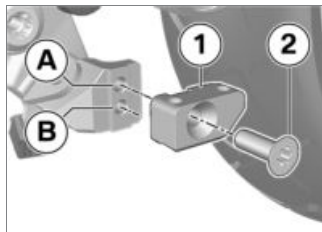

- Install clamping block **1** in the desired position **A** or **B** and tighten screw **2**.



Clamping block on footrest hinge

15 lb/ft (20 Nm)

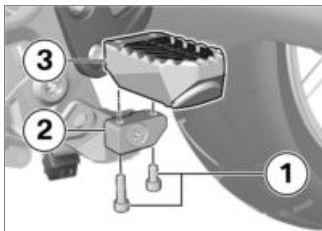

- Position footrest **3** on clamping block **2**.
- Install screws **1**.

 Footrest on clamping block

7 lb/ft (10 Nm)

- Remove and install the footrest on the other side in the same way.

Spring preload

Setting

It is essential to set the spring preload to suit the load carried by the motorcycle. Increase spring preload when the vehicle is heavily loaded and reduce spring preload accordingly when the vehicle is lightly loaded.

Adjusting spring preload at rear wheel

– without Dynamic ESA^{OE}

- Park motorcycle, ensuring that support surface is firm and level.

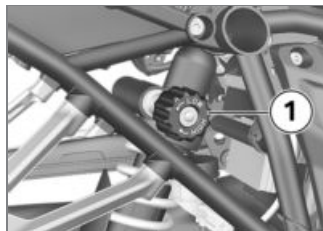

 **WARNING**

Uncoordinated settings of spring preload and spring strut damping.

Poorer handling.

- Adjust damping characteristic to changed spring preload.◀

WARNING

Adjusting the spring preload while riding.

Accident hazard

- Adjust the spring preload only when the motorcycle is stationary. ◀
- To decrease spring load, turn adjustment wheel **1** in direction of arrow LOW.
- To increase spring load, turn adjustment wheel **1** in direction of arrow HIGH.

 Basic setting of spring preload, rear

Turn adjustment wheel as far as possible into LOW direction. (One-up without load)

Turn adjuster wheel as far as possible in LOW direction, then rotate 15 turns in HIGH direction. (One-up with load)



Basic setting of spring preload, rear

Turn adjuster wheel as far as possible in HIGH direction. (Two-up and load)

Damping

– without Dynamic ESA^{OE}

Setting

The damping must be adjusted to the road conditions and the spring preload.

- A rough road surface requires softer damping than a smooth road surface.
- An increase in spring preload requires firmer damping, a reduction in spring preload requires softer damping.

Adjusting damping on rear wheel

- Park motorcycle, ensuring that support surface is firm and level.
- Adjust damping from the left side of the vehicle.



- Turn adjuster wheel **1** clockwise to increase damping.
- Turn adjuster wheel **1** counter-clockwise to decrease damping.



Basic setting of rear
wheel damping

Turn adjuster wheel clockwise
up to stop, then 6 clicks coun-
terclockwise. (One-up without
load)

Turn adjuster wheel clockwise
up to stop, then 4 clicks coun-
terclockwise. (One-up with
load)

Turn adjuster wheel clockwise
up to stop. (Two-up with load)

Riding

Safety information	124
Observe checklist.....	126
Before every journey:	127
At every third refueling stop.....	127
Starting	127
Breaking in.....	131
Shifting gears	131
Brakes	133
Parking your motorcycle	134
Refueling	135
Securing motorcycle for transportation	139

Safety information

Rider's Equipment

Do not ride without the correct clothing. Always wear:

- Helmet
- Rider's suit
- Gloves
- Boots

This applies even to short journeys, and to every season of the year. Your authorized BMW Motorrad retailer will be happy to advise you and has the correct clothing for every purpose.

Reduced clearance in inclined position

Motorcycles with lowered running gear have less ground clearance in all positions than motorcycles with standard running gear.

WARNING

When cornering with lowered motorcycles, motorcycle parts can contact the road surface sooner than normal.

Accident hazard

- Carefully test the clearance of the motorcycle in an inclined position and adjust your riding style accordingly. ◀

Test the clearance of your motorcycle at an angle in safe situations. Remember to take the limited ground clearance of your motorcycle into account when driving over curbs and similar obstacles.

The lowering of the motorcycle shortens the spring travel (see the chapter "Technical Data"). A possible reduction in the accustomed driving comfort may result. Especially when riding in two-up

mode, the spring setting should be adjusted accordingly.

Load

WARNING

Reduced riding stability caused by overloading and uneven loading

Accident hazard

- Do not exceed the gross weight limit and observe the loading information. ◀
- Adjust spring setting and damping rate for the gross vehicle weight.
- Ensure that case volumes on left and right are equal.
- Make sure that weight is uniformly distributed between right and left.
- Pack heavy pieces of luggage and cargo as low and as close to the center of the motorcycle as possible.

- Observe the maximum payload and maximum speed as indicated on the label in the case (see also the chapter "Accessories").
- with topcase^{OA}
- Observe the maximum payload and maximum speed as indicated on the label in the topcase (see also the chapter "Accessories").<
- with tank bag, small^{OA}
- Observe the maximum load capacity maximum speed of the tank rucksack.



Storage capacity of tank bag

max 11 lbs (max 5 kg)



Speed limit for riding with tank bag

max 112 mph (max 180 km/h)<

Speed

If you ride at high speed, always bear in mind that various boundary conditions can adversely affect the handling of your motorcycle:

- Incorrect settings of spring-strut and shock absorber system
- Unevenly distributed load
- Loose clothing
- Insufficient tire inflation pressure
- Tire tread in poor condition
- Etc.

Risk of poisoning

Exhaust fumes contain carbon monoxide, which is colorless and odorless but highly toxic.



WARNING

Harmful exhaust gas

Danger of suffocation

- Do not inhale exhaust fumes.

- Do not run the engine in closed rooms.<

Burn hazard



CAUTION

Intense heating up of engine and exhaust system while riding

Burn hazard

- After parking the motorcycle, make sure that no persons or objects come into contact with the engine and exhaust system.<

Catalytic converter

If misfire causes unburned fuel to enter the catalytic converter, there is a danger of overheating and damage.

The following must be observed:

- Do not run the fuel tank dry.
- Do not run the engine with the spark-plug cap removed.
- Stop the engine immediately if it misfires.
- Use unleaded fuel only.
- Comply with all specified maintenance intervals.



ATTENTION

Unburned fuel in the catalytic converter

Damage to catalytic converter

- Note the points listed for protection of the catalytic converter. ◀

Danger of overheating



ATTENTION

Engine idling for a lengthy period while at a standstill

Overheating due to insufficient cooling; in extreme cases vehicle fire

- Do not allow the engine to idle unnecessarily.
- After starting, ride off immediately. ◀

Modifications



ATTENTION

Modifications to the motorcycle (e.g. engine control unit, throttle valves, clutch)

Damage to the affected parts, failure of safety-relevant functions, expiration of warranty

- Do not make any modifications. ◀

Observe checklist

- Use the following checklist to check your motorcycle at regular intervals.

- Check operation of the brake system.
- Check operation of the lighting and signal system.
- Check clutch function (▣▶ 167).
- Checking tire tread depth (▣▶ 169).
- Checking tire pressure (▣▶ 168).
- Check secure hold of cases and luggage.
- Checking the engine oil level (▣▶ 161).
- Check front brake pad thickness (▣▶ 163).
- Checking rear brake pad thickness (▣▶ 164).
- Checking front brake fluid level (▣▶ 165).
- Checking rear brake fluid level (▣▶ 166).
- Checking coolant level (▣▶ 167).

Before every journey:

- Check operation of the brake system.
- Check operation of the lighting and signal system.
- Check clutch function (▣▣▣▶ 167).
- Checking tire tread depth (▣▣▣▶ 169).
- Checking tire pressure (▣▣▣▶ 168).
- Check secure hold of cases and luggage.

At every third refueling stop

- Checking the engine oil level (▣▣▣▶ 161).
- Check front brake pad thickness (▣▣▣▶ 163).
- Checking rear brake pad thickness (▣▣▣▶ 164).
- Checking front brake fluid level (▣▣▣▶ 165).

- Checking rear brake fluid level (▣▣▣▶ 166).
- Checking coolant level (▣▣▣▶ 167).

Starting

Start the engine

- Switch on the ignition.
 - » Pre-Ride-Check is carried out. (▣▣▣▶ 128)
 - » ABS self-diagnosis is performed. (▣▣▣▶ 128)
 - » ASC/DTC self-diagnosis is performed. (▣▣▣▶ 130)
- Engage neutral, or pull back clutch lever if a gear is engaged.



NOTICE

You cannot start the motorcycle with the side stand extended and a gear engaged. The engine will switch itself off if it is started with the transmission in neutral and

then a gear is engaged before retracting the side stand.◀

- In the case of cold start or under cold temperatures: Pull back clutch lever.
 - with HP battery^{OE}
 - » The starting response may be affected by low temperatures.<



- Press the starter button **1**.



NOTICE

The starting attempt is automatically interrupted if battery voltage is too low. Recharge the battery before you attempt to start the

engine again, or use jumper cables and a donor battery to start. More detailed information can be found in the "Maintenance" chapter under "Jump-starting". ◀

- » Engine starts.
- » If the engine fails to start, the troubleshooting table in the chapter "Technical Data" may provide assistance (▣▶ 212)

Recharge the battery before you attempt to start the engine again, or use a starting aid:

- Charge connected battery (▣▶ 183).
- Jump-starting (▣▶ 181).



NOTICE

The starting attempt is automatically interrupted if battery voltage is too low. ◀

Pre-Ride-Check

After the ignition is turned on, the instrument cluster performs a test of the instrument dials and the indicator and warning lights – this is the "Pre-Ride-Check". Starting the engine before the test routine is completed will cancel the remainder of the routine.

Phase 1

The pointer of the speedometer moves up to the end stop. At the same time, all indicator and warning lights are activated consecutively. The general warning light lights up red.

Phase 2

The pointer of the speedometer moves into the starting position. At the same time, the previously activated indicator and warning lights are now turned off in reverse sequence. The general

warning light switches from red to yellow.

If the pointer of the speedometer has not been moved, or if one of the indicator and warning lights has not been switched on:



WARNING

Defective warning lights

Lack of display of malfunctions

- Check the display of all indicator and warning lights. ◀
- Have the malfunction corrected as soon as possible at an authorized specialist workshop, preferably an authorized BMW Motorrad retailer.

ABS self-diagnosis

The self-diagnosis routine checks whether the BMW Motorrad Integral ABS is ready for operation. The self-diagnosis routine runs automatically when you switch on the ignition.

Phase 1

- » Check on system components monitored by the diagnostic system while motorcycle is parked.



ABS indicator and warning light flashes.

Phase 2

- » Check wheel sensors while starting off.



ABS indicator and warning light flashes.

ABS self-diagnosis completed

- » The ABS indicator and warning light goes out.
- Check the display of all indicator and warning lights.



ABS self-diagnosis routine not completed

ABS is not available, as the self-diagnosis routine was not completed. (The motorcycle must reach a specified minimum speed before the system can check operation of the wheel speed sensors: 3 mph (5 km/h))

If an ABS error is displayed after the ABS self-diagnosis is completed:

- It remains possible to continue riding. Please be aware that neither the ABS nor the integral function are available.
- Have the malfunction corrected as soon as possible at an authorized service facility, preferably an authorized BMW Motorrad Retailer.

ABS self-diagnosis

The self-diagnosis routine checks whether the BMW Motorcycle Integral ABS is ready for operation. The self-diagnosis routine runs automatically when you switch on the ignition. To check the wheel speed sensors, the motorcycle must be driven a few meters at a minimum speed of 3 mph (5 km/h).

Phase 1

- » Check on system components monitored by the diagnostic system while motorcycle is parked.



ABS indicator and warning light flashes.

Phase 2

- » Check wheel sensors while starting off.



ABS indicator and warning light flashes.

ABS self-diagnosis completed

» The ABS indicator and warning lamp goes out.

- Check the display of all indicator and warning lights.

An ABS error is indicated following completion of the ABS self-diagnosis routine.

- It remains possible to continue riding. Please be aware that neither the ABS nor the integral function are available.
- Have the malfunction corrected as soon as possible at an authorized specialist workshop, preferably an authorized BMW Motorrad retailer.

ASC/DTC self-diagnosis

The self-diagnosis routine is determining whether BMW Motorrad ASC/DTC is ready for operation. The

self-diagnosis routine runs automatically when you switch on the ignition.

Phase 1

» Check on system components monitored by the diagnostic system while motorcycle is parked.



ASC/DTC indicator and warning light flashes slowly.

Phase 2

» Checking the diagnosable system components while the motorcycle is moving.



ASC/DTC indicator and warning light flashes slowly.

ASC/DTC self-diagnosis completed

» The ASC/DTC indicator and warning light goes out.

- Check the display of all indicator and warning lights.



ASC/DTC self-diagnosis routine not completed

ASC/DTC is not available, as the self-diagnosis routine was not completed. (The motorcycle must reach a specified minimum speed before the system can check operation of the wheel speed sensors: 3 mph (5 km/h))

If an ASC/DTC error is displayed after the ASC/DTC self-diagnosis is completed:

- It remains possible to continue riding. It must be noted that the ASC/DTC function is not available.
- Have the malfunction corrected as soon as possible at an authorized specialist workshop, preferably an authorized BMW Motorrad retailer.

Breaking in Engine

- While running in the motorcycle, vary the throttle opening and engine-speed range frequently; avoid driving for long periods at a constant speed.
- Choose curvy, slightly hilly sections of road if possible.
- Observe the engine run-in speeds.



Engine break-in speeds

<5000 min⁻¹ (Mileage
0...621 miles (0...1000 km))

No full throttle (Mileage
0...621 miles (0...1000 km))

- Observe mileage, after which the running-in check should be performed.



Mileage until running-in
check

311...746 miles
(500...1200 km)

Brake pads

New brake pads must be run in before they achieve their optimum friction force. This initial reduction in braking efficiency can be compensated for by exerting greater pressure on the brake levers.



WARNING

New brake pads

Extension of the braking distance, accident hazard

- Brake early. ◀

Tires

New tires have a smooth surface. This must be roughened by riding in a restrained manner at various lean angles until the tires are run in. This running in procedure is essential if the tires are to achieve maximum grip.



WARNING

Loss of adhesion of new tires on wet roads and at extreme angles

Accident hazard

- Always think well ahead and avoid extreme angles. ◀

Shifting gears

Pro shift assistant

– with Gearshift Assistant Pro^{OE}



NOTICE

More detailed information on Pro Gear-shift Assistance can be

found in the section "Technology in detail". ◀



NOTICE

When changing gear using the Pro Gear-shift Assistance function, the cruise-control system is automatically deactivated for safety reasons. ◀

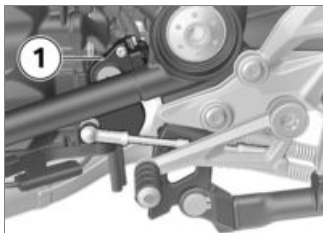

- The gears are shifted into as usual with foot force on the shift lever.
- » The sensor **1** on the gearshift shaft detects the gearshift request and triggers the shift assistance.

- » When riding at a steady speed in a low gear at high engine rpm, an attempt to shift gear without pulling the clutch can cause a severe load-change reaction. BMW Motorrad recommends disengaging the clutch for shifts in these circumstances. Use of the Pro Gear Shift Assistant should be avoided at engine speeds where the engine speed limiter becomes active.
- » Shift assistance is not available in the following situations:
 - With clutch actuated.
 - Shift lever not in its initial position.
 - When upshifting with closed throttle valve (coasting overrun) or when decelerating.
 - When downshifting with open throttle valve or when accelerating.
- To be able to make another gear shift using the Pro Gear

Shift Assistant, the gearshift lever must be fully released after the first gear change.

Shiftpoint light

– with Style HPO^E

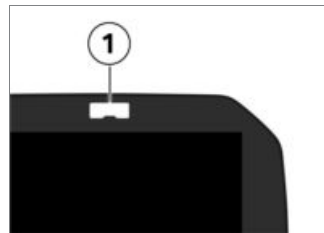

The shiftpoint light **1** signals to the rider that the engine speed is approaching the speed at which the rider needs to shift to the next highest gear.

- Shiftpoint light flashes at the preset frequency: engine speed will soon reach shifting speed

- Shiftpoint light goes out: shifting speed reached

The speed thresholds and the light behavior of the shiftpoint light can be adjusted in the `Settings`, `Vehicle settings` menu (see also the "Operation" chapter).

Brakes

How do you achieve the shortest stopping distances?

The dynamic load distribution between the front and rear wheel changes during braking. The heavier you brake, the greater the weight transfer to the front wheel. Increases in the load on an individual wheel are accompanied by a rise in the effective braking force that the wheel can provide.

To achieve the shortest possible braking distance, the front

brake must be applied quickly and with progressively greater levels of force. This procedure provides ideal exploitation of the extra weight transfer to the front wheel. The clutch should also be disengaged at the same time. The frequently-practiced procedure for "panic braking", in which maximum braking force is applied as rapidly as possible, produces deceleration rates that rise more quickly than the dynamic weight transfer occurs. As a result, a complete transfer of braking force to road surface is not possible.

Locking up of the front wheel is prevented by BMW Motorrad Integral ABS.

Descending mountain passes



Braking only with the rear-wheel brake when descending mountain passes

Reduced or braking action, destruction of the brakes caused by overheating

- Use both front and rear brakes, and make use of the engine's braking effect as well. ◀

Wet, soiled brakes

Moisture and dirt on the brake rotors and the brake pads result in a decrease in the braking action.

Delayed or poorer braking action must be expected in the following situations:

- When driving in the rain and through puddles.
- After washing the vehicle.
- When driving on roads spread with salt.
- After working on the brakes due to oil or grease residues.
- When riding on dirty roads.

 **WARNING****Poorer braking action due to moisture and dirt**

Accident hazard

- Brake until brakes are dry or clean; clean if necessary.
- Brake early until the full braking action is available again.◀

ABS Pro

- with ABS Pro^{OE}

Physical riding limits **WARNING****Braking in curves**

Danger of falling despite ABS Pro

- The rider is always responsible for adapting his/her driving style.
- Do not reduce the system's extra safety margin with careless riding or unnecessary risks.◀

ABS Pro is available in all riding modes.

Falling cannot be excluded

Although ABS Pro represents valuable support and an enormous safety advantage for the rider when braking in the inclined position, it by no means redefines the physical riding limits. It is still possible to exceed those limits through misjudgments or riding errors. In extreme cases this may result in a fall.

Use on public roads

ABS Pro helps make riding your motorcycle on public roads even safer. When braking due to unexpected hazards in curves, locking-up and slipping of the wheels is prevented within the scope of the physical riding limits.

 **NOTICE**

ABS Pro was not developed to increase the individual braking performance in the inclined position.◀

Parking your motorcycle**Side stand**

- Switch off engine.

 **ATTENTION**

Poor ground conditions in area of stand

Component damage cause by tipping over

- Always check that the ground under the stand is level and firm.◀

ATTENTION

Loading of the side stand with additional weight

Component damage cause by tipping over

- Do not sit on the motorcycle when it is parked on the side stands.◀
- Fold out side stand and park motorcycle.
- Turn the handlebars to left.
- On slopes point the motorcycle uphill and engage 1st gear.

Center stand

– with center stand^{OE}

- Switch off engine.

ATTENTION

Poor ground conditions in area of stand

Component damage cause by tipping over

- Always check that the ground under the stand is level and firm.◀

ATTENTION

Center stand folds if subject to sharp movements.

Component damage cause by tipping over

- Do not sit on the motorcycle while it is resting on the center stand.◀
- Fold out center stand and jack up motorcycle.
- On slopes point the motorcycle uphill and engage 1st gear.

Refueling

Fuel specifications Requirement

For optimal fuel economy, the gasoline should be sulfur-free or very low in sulfur content.

ATTENTION

Refueling with leaded fuel

Damage to catalytic converter

- Do not refuel with leaded gasoline or gasoline with metallic additives, e.g. manganese or iron.◀

ATTENTION

Use of Ethanol E85 as fuel

Damage to the engine and fuel supply

- Do not refuel with E85, i.e. fuel with an ethanol content of 85 %, or with Flex Fuel.◀

- Observe the maximum ethanol content of the fuel.



Recommended fuel quality

Super unleaded (max 15% ethanol, E0/E5/E10/E15)
89 AKI (95 ROZ/RON)
90 AKI



Alternative fuel quality

Regular unleaded (restrictions with regard to power and fuel consumption). (max 15% ethanol, E0/E5/E10/E15)
87 AKI (91 ROZ/RON)
87 AKI

- » After refueling with lower quality fuels, there may occasionally be a knocking noise.

Refueling procedure



WARNING

Fuel is highly flammable

Fire and explosion hazard

- Do not smoke. Never bring a naked flame near the fuel tank. ◀



WARNING

Escaping of fuel due to expansion under exposure to heat with overfilled fuel tank

Accident hazard

- Do not overfill the fuel tank. ◀



ATTENTION

Contact of fuel and plastic surfaces

Damage to surfaces (become unattractive or cloudy)

- Immediately clean plastic surfaces after contact with fuel. ◀

- Make sure ground is level and firm and place motorcycle on side stand.

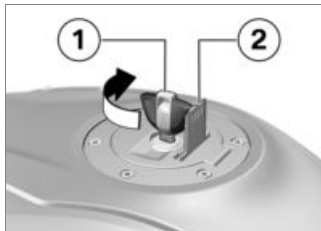

- Open protective cap **2**.
- Unlock fuel-tank cap **1** with ignition key by turning clockwise, then swivel it up.



- Refuel with a fuel meeting the specifications above, continuing until fuel is no higher than lower edge of filler neck.

NOTICE

If refueling is carried out after running on fuel reserve, the resulting filling capacity must be greater than the fuel reserve so that the new fill level is detected and the fuel reserve indicator light is switched off.◀

NOTICE

The "usable fuel quantity" specified in the technical data is the fuel quantity, which can be refueled if the fuel tank was completely emptied, i.e., if the engine dies off due to lack of fuel.◀

 Usable fuel quantity

Approx. 4.8 gal (Approx. 18 l)

 Reserve fuel quantity

Approx. 1.1 gal (Approx. 4 l)

- Press fuel tank cap down firmly to close.
- Remove vehicle key and close protective cap.

Refueling procedure

– with Keyless Ride^{OE}

Requirement

Steering lock is unlocked.

WARNING

Fuel is highly flammable

Fire and explosion hazard

- Do not smoke. Never bring a naked flame near the fuel tank.◀

WARNING

Escaping of fuel due to expansion under exposure to heat with overfilled fuel tank

Accident hazard

- Do not overfill the fuel tank.◀

ATTENTION

Contact of fuel and plastic surfaces

Damage to surfaces (become unattractive or cloudy)

- Immediately clean plastic surfaces after contact with fuel.◀
- Make sure ground is level and firm and place motorcycle on side stand.
- Switch off ignition (▶▶▶ 59).



NOTICE

After the ignition is switched off, the fuel filler cap can be opened within the specified run-on time even without the radio-operated key being within the reception area.◀



After-running period for opening the fuel filler cap

2 min

- » There are **2 ways** to open the fuel filler cap:
- Within the after-running period.

- After the after-running period expires.

Version 1

- with Keyless Ride^{OE}

Requirement

Within the run-on time:

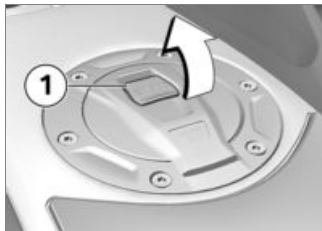

- Slowly pull lug **1** of fuel filler cap upward.
- » Fuel filler cap unlocked.
- Open fuel filler cap completely.

Version 2

- with Keyless Ride^{OE}

Requirement

After run-on time expires:

- Bring radio-operated key into reception range.
- Slowly pull up lug **1**.
- » The indicator light for the radio-operated key flashes as long as the radio-operated key is being searched for.
- Slowly pull lug **1** of fuel filler cap upward again.
- » Fuel filler cap unlocked.
- Open fuel filler cap completely.



- Refuel with a fuel meeting the specifications above, continuing until fuel is no higher than lower edge of filler neck.

NOTICE

If refueling is carried out after running on fuel reserve, the resulting filling capacity must be greater than the fuel reserve so that the new fill level is detected and the fuel reserve indicator light is switched off.◀

NOTICE

The "usable fuel quantity" specified in the technical data is the fuel quantity, which can be refueled if the fuel tank was completely emptied, i.e., if the engine dies off due to lack of fuel.◀



Usable fuel quantity

Approx. 4.8 gal (Approx. 18 l)



Reserve fuel quantity

Approx. 1.1 gal (Approx. 4 l)

- Press fuel filler cap of fuel tank down firmly.
 - » Fuel filler cap audibly engages.
 - » Fuel filler cap automatically locks after run-on time expires.
 - » The engaged fuel filler cap locks immediately when the

steering lock is locked or during starting.

Securing motorcycle for transportation

- Protect against scratching all components along which luggage straps are routed. For example, use adhesive tape or soft cloths.



ATTENTION

Motorcycle tips to the side when raising

Component damage cause by tipping over

- Secure the motorcycle against tipping to the side, preferably with the assistance of a second person.◀
- Push the motorcycle onto the transportation flat and hold it in position: do not place it on the side stand or center stand.

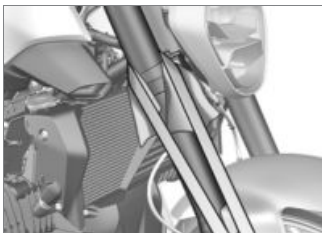

ATTENTION

Pinching of components

Component damage

- Do not pinch components, e.g. brake lines or wiring harnesses.◀
- Pass the straps on the left and right through the fork bridge and strap the motorcycle down.



- Fasten the rear tensioning straps on both sides of the holder for the passenger footrests and tighten.
- Tension all straps evenly so that the vehicle is securely fastened.

Technology in detail

General notes.....	142
Antilock Braking System (ABS)	142
Traction control (ASC/DTC).....	145
Dynamic ESA.....	147
Riding mode	148
Dynamic Brake Control	149
Tire pressure control (TPC/ RDC)	150
Shift assistant.....	152
Hill Start Control (Hill Start Con- trol)	153
ShiftCam	155

General notes

More information on the topic of technology is available at:

bmw-motorrad.com/technology

Antilock Braking System (ABS)

Partially integral brake

Your motorcycle is equipped with a partially integral brake configuration. Both front and rear brakes are applied simultaneously when you pull the handbrake lever.

The footbrake lever acts only on the rear brake.

BMW Motorrad Integral ABS adapts the brake force distribution between the front and rear brakes during braking by means of ABS modulation to suit the load carried by the motorcycle in order to achieve the shortest possible braking distance.



ATTENTION

Attempt at a burn-out despite integral function

Damage to rear-wheel brake and clutch

- Do not perform burn-out. ◀

How does the ABS work?

The maximum braking force that can be transferred to the road surface is partially dependent on the friction coefficient of the road surface. Gravel, ice, snow and wet roads offer a considerably lower friction coefficient than a dry, clean asphalt surface. The poorer the friction coefficient of the road surface is, the longer the braking distance will be.

If the maximum transferable braking force is exceeded when the rider increases the brake pressure, the wheels begin to lock and driving stability is lost, and a fall can result. Before this sit-

uation occurs, ABS is activated and the brake pressure is adjusted to the maximum transferable braking force. This enables the wheels to continue to turn and maintains driving stability regardless of the road surface condition.

What happens when rough roads are encountered?

Bumpy or rough roads can briefly lead to a loss of contact between the tires and the road surface, until the transferable braking force is reduced to zero. If braking is carried out in this situation, ABS must reduce the brake pressure to ensure driving stability when restoring contact to the road. At this point in time, the ABS must assume extremely low friction coefficients (gravel, ice, snow) so that the running wheels turn in every imaginable case and

the driving stability is ensured. After detecting the actual conditions, the system adjusts the optimum brake pressure.

In what ways is the ABS noticeable to the rider?

If the ABS system has to reduce the braking force due to the conditions described above, then vibrations can be felt through the handlebar brake lever.

If the handbrake lever is pulled, then braking pressure is built up at the rear wheel with the integral function. If the footbrake lever is first actuated after this, the brake pressure already built up can be felt earlier than the counter-pressure, than when the footbrake lever is actuated before or together with the handbrake lever.

Lifting off rear wheel

However, during extremely heavy and rapid decelerations it is possible that the ABS cannot prevent the rear wheel from lifting off the ground. In these cases, the motorcycle can also flip end over end.



Lifting off of the rear wheel due to heavy braking

Accident hazard

- When braking heavily, bear in mind that the ABS control cannot always be relied on to prevent the rear wheel from lifting off the ground. ◀

What are the design characteristics of the ABS?

The ABS ensures driving stability on any surface within the limits of driving physics. The system is not optimized for special requirements resulting under extreme weather conditions on the racetrack. Handling should be adopted to driving skills and road conditions.

Special situations

To detect the tendency of the wheels to lock up, the speeds of the front and rear wheel are compared. If the system registers implausible data for an extended period of time it will deactivate the ABS as safety precaution and a display will alert you to an ABS error. A self-diagnosis routine must be completed before the error will be displayed.

Apart from problems with the BMW Motorrad ABS, unusual riding conditions can also cause a fault message to be generated:

- Warm-up on the center or auxiliary stand at idle or with gear engaged.
- Rear wheel locked-up for a longer period of time by engine brake, e.g. when riding downhill on slippery surfaces.

Should a fault code occur due to an unusual driving condition, the ABS function can be reactivated by switching the ignition off and then on again.

How important is regular maintenance?



WARNING

Failure to have maintenance performed on the brake system regularly.

Accident hazard

- To ensure that the ABS is in a properly maintained condition, it is vital that the specified service intervals be observed. ◀

Reserves for safety

But remember: the potentially shorter braking distances which ABS permits must not be used as an excuse for careless riding. ABS is primarily a means of ensuring a safety margin in genuine emergencies.



WARNING

Braking in curves

Risk of accident despite ABS

- The rider is always responsible for adapting his/her driving style.
- Do not reduce the additional safety function with careless riding or unnecessary risks. ◀

Further development of ABS to ABS Pro

– with ABS Pro^{OE}

In the past, the BMW Motorrad ABS system provided for a very high level of safety while braking during straight-ahead riding. Now ABS Pro also offers increased safety even when braking in curves. ABS Pro prevents locking-up of the wheels even in case of rapid brake actuation. ABS Pro reduces abrupt changes in steering forces, especially during panic braking, and therefore decreases the risk of unwanted wheelies occurring.

ABS control

From a technical standpoint, ABS Pro adjusts the ABS control to the angle of inclination of the motorcycle in dependence on the respective riding situation. Signals for the roll and yaw rate

and the lateral acceleration are used to determine the inclination of the motorcycle.

With an increasing inclination, the braking pressure gradient is increasingly limited at the start of braking. This results in a slower pressure buildup. In addition, the pressure modulation in the range of the ABS control is more uniform.

Advantages for the rider

The advantages of ABS Pro for the rider are sensitive response and high braking and riding stability with the best possible deceleration, even in curves.

Traction control (ASC/DTC)

How does traction control work?

Traction Control is available in two versions

- **Without** taking the angle into account: Automatic Stability Control ASC
- ASC is a rudimentary function intended to prevent falls.
- **With** taking the angle into account: Dynamic Traction Control DTC
- The additional inclined position and acceleration information enables the DTC to make more precise and comfortable adjustments.

The traction control compares the speeds at the perimeters of the front and rear wheel. The slip, and with it the stability reserves at the rear wheel, are de-

termined from the speed difference. The engine management system adapts the engine torque when the slip limit is exceeded. BMW Motorrad ASC/DTC is designed as an assistance system for the rider and for riding on public roads. The extent to which the rider affects ASC/DTC control can be considerable (weight shifts when cornering, loose luggage on the motorcycle), especially when approaching the limits imposed by the laws of physics.

The *Enduro* riding mode should be activated for off-road riding. In this mode, the controlling intervention by the ASC/DTC is carried out later, enabling controlled drifting.

The system is not optimized for the special conditions encountered under extreme weather during off-road and race-track use. BMW Motorrad ASC/DTC

can be switched off under these conditions.



WARNING

Risky riding style

Accident hazard despite ASC/DTC

- The rider is always responsible for adapting his/her driving style.
- Do not reduce the system's extra safety margin with careless riding or unnecessary risks. ◀

Special situations

As lean angles increase, acceleration potential is also progressively restricted by the laws of physics. This can result in reduced acceleration when coming out of very tight curves.

To detect spinning or slipping away of the rear wheel, among other things the speeds of the front and rear wheel are compared and the angle with DTC compared to ASC is taken into account.

- with riding modes Pro^{OE}

If the value for the angle are detected to be implausible for a long period, a replacement value is used for the angle or the DTC function is deactivated. In these cases, a DTC error is displayed. A self-diagnosis routine must be completed before the error will be displayed.

Under the following unusual riding conditions, BMW Motorrad Traction Control may be deactivated automatically.

Unusual riding conditions:

- Driving on the rear wheel (wheelie) for a longer period.

- Rear wheel spinning in place with front brake engaged (burn out).
- Heating up on an auxiliary stand at idle speed or with gear engaged.



Minimum speed for DTC activation

min 3 mph (min 5 km/h)

If the front wheel loses contact with the ground under extreme acceleration, the ASC or DTC function reduces the engine torque in the RAIN and ROAD riding modes until the front wheel makes contact with the ground again.

In the DTC settings DYNAMIC and DYNAMIC PRO, the front wheel lift-off detection permits brief wheelies.

In the RAIN, ROAD and DYNAMIC riding modes, the

DTC settings corresponds to the riding mode.

In the DYNAMIC PRO riding mode, DTC can be set differently (➡ 75).

BMW Motorrad recommends that you respond to the front wheel lifting off by twisting back the throttle grip somewhat to return to a stable driving condition as quickly as possible.

On a slippery surface, the throttle grip should never be suddenly twisted back completely unless the clutch is disengaged at the same time. The engine braking torque can cause the rear wheel to slip, resulting in an unstable driving state. This case cannot be controlled by BMW Motorrad DTC.

Dynamic ESA

– with Dynamic ESA^{OE}

Riding position compensation

The Dynamic ESA electronic chassis setting can automatically adapt your motorcycle to the load. If the spring setting is set to **Auto**, the rider does not have to worry about adjusting the load.



BMW Motorrad recommends the **Auto** chassis and suspension adjustment. ◀

When the motorcycle is started and while it is being driven, the system monitors the compression of the rear wheel and corrects the spring setting to ensure that the correct driving position is set. The damping is also automatically adjusted to the load.

Using ride height sensors, Dynamic ESA detects the movements of the chassis and suspension and responds to them by adjusting the EDC valves. As a result, the chassis and suspension is adjusted to the conditions of the surface. Dynamic ESA calibrates itself at regular intervals to ensure that the system is operating correctly.

Adjustment options

Damping modes

- Road: Damping for comfortable road travel
- Dynamic: Damping for dynamic road travel

Load settings

- Auto: Active riding position compensation with automatic setting of spring setting and damping (recommended chassis setting)

- Min: Minimum spring setting (only suitable for one-up mode)
- Max: Maximum spring setting (only suitable for two-up mode)

Riding mode

Selection

In order to adjust the motorcycle to the road condition and the desired riding experience, it is possible to select one of the following riding modes:

- RAIN
- ROAD (standard mode)
- with riding modes Pro^{OE}
- DYNAMIC
- DYNAMIC PRO

For each of these riding modes, there is a coordinated setting for the ABS and ASC/DTC systems as well as for the throttle response.

- with Dynamic ESA^{OE}
- The coordination of the Dynamic ESA also depends on the selected riding mode.

ABS and/or ASC/DTC can be switched off in each riding mode. The following explanations always refer to the riding safety systems that are switched on.

Throttle response

- In riding mode RAIN: Reserved
- In riding mode ROAD: Direct
- In the DYNAMIC and DYNAMIC PRO riding modes: dynamic
- In the DYNAMIC PRO riding mode, the throttle response can be set differently via the SETUP (➡ 73).

ABS

- Rear wheel lift-off detection is active in all riding modes.

- In the RAIN, ROAD, DYNAMIC, and DYNAMIC PRO riding modes, the ABS is set for road use.

- with riding modes Pro^{OE}
- In the RAIN, ROAD, DYNAMIC, and DYNAMIC PRO riding modes, the ABS Pro is available to its full capacity. The inclination the motorcycle has when braking in curves is reduced to a minimum.

ASC

- Front wheel lift-off detection is active in all riding modes.
- ASC is set for road use.
- In the ROAD riding mode, ASC provides high riding stability, and maximum riding stability in the RAIN riding mode.

- with riding modes Pro^{OE}

DTC

Tires

- In the DTC settings RAIN, ROAD, and DYNAMIC, the DTC is set for road use with road tires.

Riding stability

- In the DTC setting RAIN, the DTC intervenes early enough to ensure that maximum riding stability is achieved.
- In the DTC setting ROAD, the DTC intervenes later than in RAIN riding mode. A rear wheel spin is avoided wherever possible.
- In the DTC settings RAIN and ROAD, the front wheel is prevented from lifting off.
- In the DTC setting DYNAMIC, the DTC intervenes later than in the DTC setting ROAD, which enables minor drifts at

the end of curves and brief wheelies.

In the RAIN, ROAD and DYNAMIC riding modes, the DTC settings corresponds to the riding mode.

In the DYNAMIC PRO riding mode, DTC can be set differently (➡ 75).

Changing setting

Riding modes can be changed when the vehicle is at a standstill with the ignition switched on. A changeover while riding is possible under the following conditions:

- No drive torque at rear wheel.
- No brake pressure in the braking system.

For a changeover while riding, the following steps must be carried out:

- Turn back throttle grip.
- Do not actuate brake lever.
- Deactivate the cruise control.

First the desired riding mode is preselected. The new selection is not activated until the specified conditions are present in all affected systems.

The selection menu does not disappear in the display until the riding mode has been switched over.

Dynamic Brake Control

- with riding modes Pro^{OE}

Dynamic Brake Control function



NOTICE

The Dynamic Brake Control function is active in all riding modes when the ABS is switched on.◀

The Dynamic Brake Control function helps the rider in the event of emergency braking.

Detection of emergency braking

- Emergency braking is detected when the front wheel brake is applied quickly and with force.

Behavior during emergency braking

- If emergency braking is applied at a speed of more than 10 km/h, in addition to the ABS function the Dynamic Brake Control function will also be activated.
- In the event of partial braking with high brake pressure gradients, Dynamic Brake Control will increase the integral brake pressure on the rear wheel. This shortens the braking distance, enabling controlled braking.

Behavior in the event of accidental activation of the throttle grip

- If the throttle grip is accidentally activated during emergency braking (throttle position >5%), the intended braking effect is ensured by the Dynamic Brake Control by shutting off the gas. This ensures activation of emergency braking.
- If the gas is shut off (throttle position <5%) during the intervention of the Dynamic Brake Control, the engine torque required by the ABS brake system will be restored.
- If the emergency braking is stopped and the throttle grip is still activated, the Dynamic Brake Control reduces the engine torque as required by the rider in a controlled manner.



NOTICE

When the ABS is switched off, the Dynamic Brake Control function is switched off at the same time.◀

Tire pressure control (TPC/RDC)

- with tire pressure monitor (TPM)^{OE}

Operation

A sensor located in each tire monitors the air temperature and the inflation pressure inside the tire and transmits this information to the control unit.

The sensors are equipped with a centrifugal governor, which does not enable the transmission of the measured readings until the defined minimum speed is exceeded for the first time.



Minimum speed for transmission of TPC/RDC measured data:

min 19 mph (min 30 km/h)

Before the tire pressure is received for the first time, "--" is shown on the display for each tire. The sensors continue to transmit the measured readings for some time after the vehicle comes to a stop.



Duration of measured data transmission after motorcycle is stationary:

min 15 min

If an TPC/RDC control unit is fitted but the wheels have no sensors, a fault message is generated.

Tire inflation pressure ranges

The TPC/RDC control unit distinguishes between three inflation pressure ranges matched to the motorcycle:

- Inflation pressure within the permissible tolerance.
- Inflation pressure at the limits of the permissible tolerance.
- Inflation pressure outside the permissible tolerance.

Temperature compensation

The tire inflation pressure is temperature dependent, i.e. it increases or decreases together with the tire air temperature. The tire temperature is dependent on the outside temperature, the riding style and the length of the journey.



The tire pressures are shown in the TFT display with temperature compensation and are always based on the following tire air temperature:

68 °F (20 °C)

Tire pressure gages at gas stations do not make any adjustment for the air temperature, the tire pressure indicated depends on the temperature of the air in the tire. As a result, in most cases the values displayed there do not match the values shown in the TFT display.

Tire pressure adjustment

Compare the TPC/RDC value in the TFT display with the value on the back cover of the operating instructions. The difference between the two values must be compensated with the tire infla-

tion pressure tester at the filling station.

 Example
According to the rider's manual, the tire pressure should have the following value:
33.3 psi (2.5 bar)
The following value is displayed in the TFT display:
33.4 psi (2.3 bar)
Missing is thus:
2.9 psi (0.2 bar)
The tester at the filling station shows:
34.8 psi (2.4 bar)
To produce the correct tire pressure, this must be increased to the following value:
37.7 psi (2.6 bar)

Shift assistant

- with Gearshift Assistant Pro^{OE}

Shift assistant Pro

Your motorcycle is equipped with a Pro gearshift assistant originally developed for racing but now specially adapted for touring use. It allows you upshift and downshift under almost any load conditions and in virtually all engine-speed ranges without operating the clutch or accelerator.

Benefits

- 70-80 % of all gear changes can be performed without using the clutch.
- Less movement between pilot and pillion due to shorter gear-change intervals.
- Throttle does not have to be closed when changing gear under acceleration.

- During deceleration and downshifts (throttle plate closed) the system blips the throttle to obtain the correct engine speed.
- Shifting times are faster than when the clutch is used to change gears.

For the system to detect the rider's intention to change gear, the gearshift lever previously not operated must be moved against the force of the spring by a certain amount of "overtravel" in the desired direction with a normal to brisk action and held in that position until the gear change is completed. A further increase of the force applied to the gearshift lever during the gear-shift operation is not necessary. After the gear change is completed, the gear lever must be fully released before the Pro gearshift assistant can execute a new gear change. The load factor (throt-

tle grip position) should remain constant both prior to and during execution of shifts using the Pro gearshift assistant. Changing the accelerator twist-grip position during the gear-shift operation may cause the function to abort and/or the gear change to fail. The Pro gearshift assistant does not provide support when gear changes are made using the clutch.

Downshifts

- Downshifts are assisted up to the speed at which the engine reaches maximum rpm in the gear to be engaged. Over-revving is thus prevented.

 Maximum engine speed
max 9000 min ⁻¹

Upshifts

- Upshifting is only possible if the current RPM is higher than the release threshold for the next higher gear.
- This prevents the idling speed from being dropped below.

 Idle speed
1050 min ⁻¹ (Engine at operating temperature)

 Release thresholds
1st gear
min 1350 min ⁻¹
2nd gear
min 1400 min ⁻¹
3rd gear
min 1450 min ⁻¹
4th gear

 Release thresholds
min 1500 min ⁻¹
5th gear
min 1550 min ⁻¹
6th gear
min 1600 min ⁻¹

Hill Start Control (Hill Start Control)

Hill Start Control function

The Hill Start Control prevents an uncontrolled rolling back on slopes by means of targeted intervention in the partial integral ABS brake system, without the rider having to continuously operate the brake lever. When Hill Start Control is activated, pressure builds in the rear brake system so that the motorcycle remains stationary on a sloping surface.

The brake pressure in the brake system depends on the gradient.

Influence of gradient on brake pressure and starting behavior

- Stopping on a slight incline builds up only a small amount of brake pressure. The brake is released quickly when driving off, making it possible to drive off more smoothly. Additional turning of the throttle grip is hardly necessary.
- Stopping on a steeper slope increases the amount of brake pressure built up. The brake is a bit slower to release when driving off. More torque is required to drive off, making additional turning of the throttle grip necessary.

Behavior when the vehicle is rolling or slipping

- The brake pressure increases when the vehicle is rolling with Hill Start Control active.
- If the rear wheel slips, the brake is released again after approx. 1 m. This prevents the vehicle from rolling with the rear wheel blocked.

Releasing the brake when switching off the engine or during timeout

Hill Start Control is deactivated when the engine is switched off using the emergency-off switch, when the side stand is folded out, or after it times out (10 minutes).

In addition to the indicator and warning lights, the rider is to be made aware about the deactivation of the Hill Start Control by the following behavior:

Brake warning jerk

- The brake is released briefly and is immediately reactivated.
- This causes a jerking behavior that the rider can feel.
- The partial integral ABS brake system sets a speed of approx. 1-2 km/h.
- The rider must brake the vehicle manually.
- After two minutes, or when the brake is applied, Hill Start Control is deactivated completely.



NOTICE

When the ignition is switched off, the holding pressure is built up immediately and without brake warning jerk. ◀

ShiftCam

Principle of ShiftCam function

The motorcycle is equipped with the BMW ShiftCam technology - a technique for varying the valve timing and the valve stroke on the inlet side. The centerpiece of this technology is a one-piece inlet trip camshaft that has two cams per valve to be actuated: one for partial load and one for full load. The partial load cam has been developed with regard to fuel economy optimization and smooth running. The partial load cam reduces both the control times adapted for this purpose and the inlet valve stroke. Furthermore, the inlet cams for the left and right inlet valve differ in stroke and angle position when the partial load cam is activated. This causes a staggered opening of the two in-

let valves, which have different widths. The advantage is that the fuel-air mixture flowing into the combustion chamber is more strongly swirled and more effectively burned. Overall, this results in optimal fuel efficiency and noticeably improves the smoothness of running. The full load cam is optimized for performance and releases the maximum inlet valve stroke. In order to vary the valve timing and the valve stroke, the inlet camshaft is shifted axially. For this purpose, the pins of an electromechanical actuator mesh with a shift gate on the inlet camshaft. This allows for the actuation of the inlet valves depending on load and motor speed and, as a result, an uncompromising symbiosis of performance and low fuel consumption.

Maintenance

General notes.....	158	Jump-starting.....	181
On-board tool kit.....	158	Battery.....	182
Service tool set	158	Fuses.....	186
Front wheel stand	159	Data link connector	188
Rear-wheel stand	160		
Engine oil	161		
Brake system	162		
Clutch	167		
Coolant	167		
Tires	168		
Wheel rims and tires	168		
Wheels	169		
Muffler.....	176		
Air filter	177		
Light sources	179		

General notes

The Maintenance chapter describes work involving the checking and replacement of wear parts that can be performed with a minimum of effort.

If special tightening torques are to be taken into account for assembly, these are listed. An overview of all required tightening torques is contained in the Technical Data chapter.

Information on additional maintenance and repair work is provided in the Repair Manual for your motorcycle on DVD, which you can obtain from your authorized BMW Motorrad retailer.

Special tools and thorough specialized knowledge are required to carry out some of the work described here. If you are in doubt, consult an authorized workshop, preferably your authorized BMW Motorrad retailer.

On-board tool kit

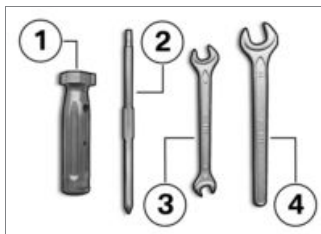

- 1** Screwdriver handle
 - Use with screwdriver insert
 - Topping up the engine oil (➡ 162).
- 2** Reversible screwdriver insert
 - Phillips PH1 and Torx T25
 - Remove light sources in front and rear turn indicators (➡ 179).
 - Remove battery cover (➡ 184).
- 3** Open-ended wrench
 - Wrench size: 8/10 mm

- 3** – Removing battery (➡ 184).
- 4** Open-ended wrench
 - Wrench size: 14
 - Adjust mirror arm (➡ 112).

Service tool set

– with service tool set^{OA}

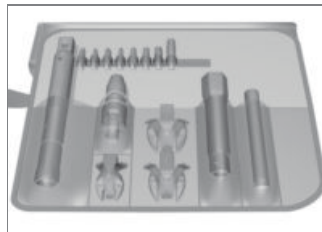

For expanded servicing (e.g. fitting and removing wheels), BMW Motorrad has set up a service toolkit designed for your motorcycle. You can obtain the toolkit from your BMW Motorrad retailer.

Front wheel stand

Mount front wheel stand

ATTENTION

Use of the BMW Motorrad front wheel stand without an additional center or auxiliary stand

Component damage cause by tipping over

- Place the motorcycle on the center stand or an auxiliary stand before lifting it with the BMW Motorrad front wheel stand. ◀
- Place motorcycle on center stand, ensuring that it is resting on a firm and level support surface.
- Use basic stand with front wheel mount. The base stand and its accessories are available through your authorized BMW Motorrad retailer.

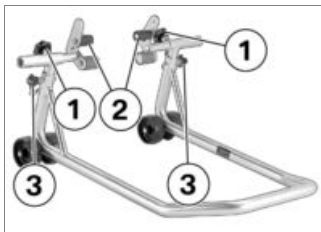

- Loosen mounting bolts **1**.
- Push two mounts **2** outward, continuing until front suspension fits between them.
- Use locating pins **3** to set front wheel stand to desired height.
- Center front wheel stand relative to front wheel and push it against front axle.

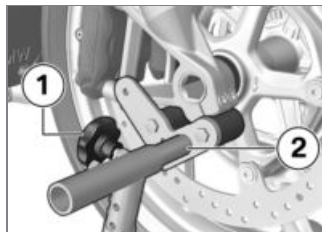

- Align two mounts **2** so that front suspension rests securely on them.
- Tighten securing screws **1**.

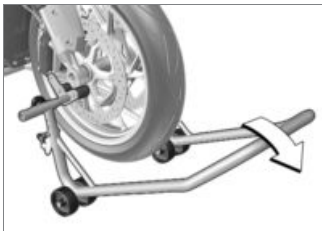

ATTENTION

Center stand retracts if motorcycle is lifted too high.

Component damage cause by tipping over

- When raising the motorcycle, make sure that the center stand remains on the ground. ◀
- Apply uniform pressure to push front wheel stand down and raise motorcycle.

Rear-wheel stand

Mounting rear-wheel stands

- Park motorcycle, ensuring that support surface is firm and level.
- Use basic stand with rear wheel adapter. The basic stand and its accessories are available through your authorized BMW Motorrad retailer.

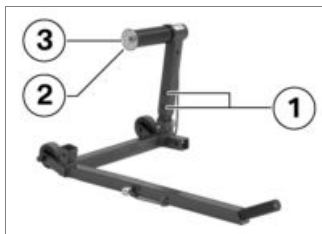

- Set desired height of rear-wheel stand using bolts **1**.

- Remove the lock washer **2**; to do so, press the unlock button **3**.



- Push the rear-wheel stand from the right onto the rear axle.
- Apply the retaining disk from the left; to do so, press the unlock button.



- Position motorcycle upright while simultaneously pressing grip of stand back so that both stand rollers rest on ground.
- Then press the grip down to the ground.

Engine oil

Checking the engine oil level

NOTICE

It is possible to misinterpret the oil capacity as the oil level depends on the temperature. ◀

- Check that the motorcycle is at operating temperature and place it on its center stand, making sure the ground is level and firm.
- Run the engine at idle until the fan starts.
- Switch off engine at operating temperature.
- Wait five minutes to allow oil to drain to the oil pan.

NOTICE

BMW Motorrad recommends occasionally checking the motor oil after a journey of at least 50 km in order to reduce the environmental impact. ◀

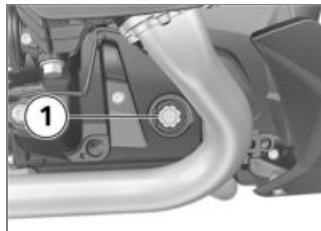

- Read oil level on the display **1**.

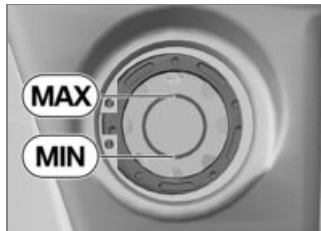

 Specified level of engine oil

Between MIN and MAX mark

If oil level is below MIN mark:

- Topping up the engine oil (▮▮▮ 162).

If the oil level is above the MAX mark:

- Have oil level corrected at an authorized service facility, preferably an authorized BMW Motorrad retailer.

Topping up the engine oil

- Park motorcycle on a level, firm surface.

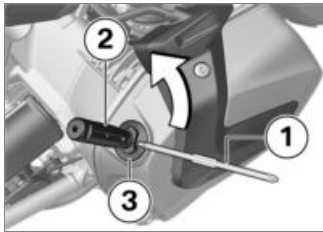

- Wipe the area around the oil filler opening clean.

- To be able to apply force more easily, insert the interchangeable screwdriver insert **1** Torx-end first, into the screwdriver handle **2** (from on-board tool kit).
- Position the specified tool from the on-board tool kit on the cap **3** of the oil filler opening and turn counter-clockwise to remove it.
- Checking the engine oil level (▮▮▮ 161).



ATTENTION

Use of too little or too much engine oil

Engine damage

- Always make sure that the oil level is correct. ◀
- Top up the engine oil to the specified level.



Engine oil, quantity for topping up

max 0.8 quarts (max 0.8 l) (Difference between MIN and MAX)

- Checking the engine oil level (▮▮▮ 161).
- Install the cap **3** of the oil filler opening.

Brake system

Checking brake operation

- Actuate the handbrake lever.
 - » Pressure point must be clearly perceptible.
- Actuate the footbrake lever.
 - » Pressure point must be clearly perceptible.

If no clear pressure points are perceptible:

ATTENTION

Improper working on the brake system

Endangering of the operating safety of the brake system

- Have all work on the brake system carried out by experts. ◀
- Have the brakes checked at an authorized workshop, preferably an authorized BMW Motorrad retailer.

Check front brake pad thickness

- Park motorcycle, ensuring that support surface is firm and level.

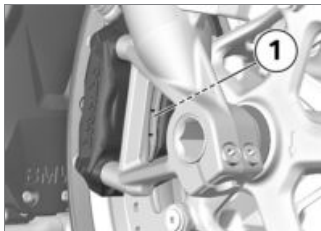

- Visually inspect left and right brake pads to determine their thickness. Viewing direction: between wheel and front suspension toward brake pads **1**.



 Front brake-pad wear limit

0.04 in (1.0 mm) (Only friction material without carrier plate. Wear markings (grooves) must be clearly visible.)

If the wear indicators are no longer clearly visible:

WARNING

Dropping below the minimum pad thickness

Reduced braking action, damage to the brake

- In order to ensure the operating reliability of the brake system, make sure that the brake pads are not worn beyond their minimum thickness. ◀
- Have brake pads replaced at an authorized service facility, preferably an authorized BMW Motorrad retailer.

Checking rear brake pad thickness

- Park motorcycle, ensuring that support surface is firm and level.



- Conduct a visual inspection of the brake pad thickness. Direction of view: From rear looking at brake pads **1**.



Rear brake-pad wear limit

0.04 in (1.0 mm) (Only friction material without carrier plate)

If wear limit is reached:

! WARNING

Dropping below the minimum pad thickness

Reduced braking action, damage to the brake

- In order to ensure the operating reliability of the brake system, make sure that the brake pads are not worn beyond their minimum thickness.◀
- Have brake pads replaced at an authorized service facility, preferably an authorized BMW Motorrad retailer.

Checking front brake fluid level

! WARNING

Insufficient brake fluid in the brake-fluid reservoir

Considerably reduced braking performance caused by air in the brake system

- Adjust the riding mode immediately until the fault is rectified.
- Check brake fluid level regularly.◀
 - with center stand^{OE}
- Make sure ground is level and firm and place motorcycle on its center stand.◀
 - without center stand^{OE}
- Make sure ground is level and firm and hold motorcycle vertically.◀
- Align handlebars so that brake-fluid reservoir is positioned horizontally.



- Check brake fluid level in front brake-fluid reservoir **1**.

F NOTICE

The brake fluid level in the brake-fluid reservoir drops due to brake pad wear.◀



Front brake fluid level

Brake fluid, DOT4

The brake fluid level must not fall below the MIN mark. (Brake-fluid reservoir horizontal, motorcycle standing upright)

If brake fluid level falls below the approved level:

- Have defect corrected as soon as possible by an authorized workshop, preferably an authorized BMW Motorrad retailer.

Checking rear brake fluid level



WARNING

Insufficient brake fluid in the brake-fluid reservoir

Considerably reduced braking performance caused by air in the brake system

- Adjust the riding mode immediately until the fault is rectified.
- Check brake fluid level regularly. ◀
 - with center stand^{OE}
 - Make sure ground is level and firm and place motorcycle on its center stand. ◀
 - without center stand^{OE}
 - Make sure ground is level and firm and hold motorcycle vertically. ◀

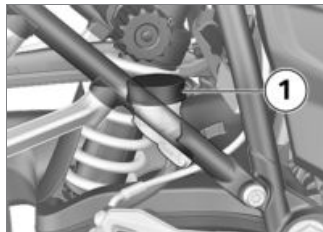

- Read brake fluid level at rear brake-fluid reservoir **1**.



NOTICE

The brake fluid level in the brake-fluid reservoir drops due to brake pad wear. ◀



Rear brake fluid level

Brake fluid, DOT4

The brake fluid level must not fall below the MIN mark. (Brake-fluid reservoir horizontal, motorcycle standing up-right)

If brake fluid level falls below the approved level:

- Have defect corrected as soon as possible by an authorized workshop, preferably an authorized BMW Motorrad retailer.

Clutch

Check clutch function

- Pull back the clutch lever.
- » Pressure point must be clearly perceptible.

If no clear pressure point can be felt:

- Have the clutch checked by an authorized workshop, preferably an authorized BMW Motorrad retailer.

Coolant

Checking coolant level

- Fold out the side stand and stand to the right of the motorcycle.
- Hold motorcycle straight.
 - with center stand^{OE}
- Place motorcycle on center stand, ensuring that it is resting on a firm and level support surface.<



CAUTION

Hot engine

Burn hazard

- Maintain a safe distance from the hot engine.
 - Do not touch the hot engine.<
 - Read the coolant level on the expansion tank **1**.
 - » Coolant level must be between MIN and MAX marks.
- If coolant level drops below MIN mark:
- Add coolant.

Topping up coolant



- Open the cap **1** of the coolant expansion tank and top up coolant to the specified level.
- Checking coolant level (→ 167).
- Close the cap **1** of the coolant expansion tank.

Tires

Checking tire pressure



WARNING

Incorrect tire inflation pressure

Poorer handling characteristic of motorcycle, reduction of tire service life

- Ensure proper tire inflation pressure. ◀



WARNING

Automatic opening of vertically installed valve inserts at high speeds

Sudden loss of tire inflation pressure

- Use valve caps with rubber sealing ring and screw on firmly. ◀
- Park motorcycle, ensuring that support surface is firm and level.
- Check tire pressures against data below.



Tire pressure, front

36.3 psi (2.5 bar) (with tire cold)



Tire pressure, rear

42.1 psi (2.9 bar) (with tire cold)

If tire pressure is too low:

- Correct tire pressure.

Wheel rims and tires

Check wheel rims

- Park motorcycle, ensuring that support surface is firm and level.
- Subject wheel rims to visual inspection for defects.
- Have damaged rims checked and, if necessary, replaced by a specialist service facility.

ity, preferably an authorized BMW Motorrad retailer.

Checking tire tread depth



Riding with heavily worn tyres

Risk of accident due to poorer rideability

- If necessary, replace the tyres before the legally specified minimum tread depth is reached. ◀
- Park motorcycle, ensuring that support surface is firm and level.
- Check tire tread depth in main tread grooves with wear indicators.



Tread wear marks are integrated into the main grooves on every tire. If the tire tread has worn

down to the level of the marks, the tire is completely worn. The locations of the marks are indicated on the edge of the tire, e.g. by the letters TI, TWI or by an arrow. ◀

When the minimum tread depth is reached:

- Replace the worn tires.

Wheels

Affect of wheel sizes on suspension control systems

The wheel sizes play a major role in the ABS and ASC/DTC suspension-control systems. The diameter and width of the wheels stored in the control unit have particular significance as the basis for all necessary calculations. A change in these sizes resulting from conversion to wheels not installed as standard equipment

can seriously affect the control efficiency of these systems. The sensor rings required for wheel speed detection must also match the installed control systems and may not be replaced. If you want to equip your motorcycle with different wheels, please contact a specialist service facility, preferably a BMW Motorrad retailer. In some cases the data stored in the control units can be adapted for the new wheel sizes.

TPC/RDC label

- with tire pressure monitor (TPM)^{OE}

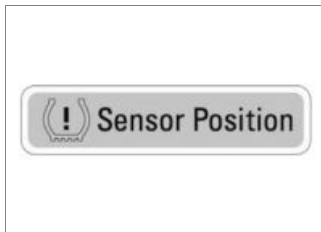

ATTENTION

Improper tire removal

Damage to the TPC/RDC sensors

- Inform a specialist service facility or an authorized BMW Motorrad retailer on the fact that the wheel is equipped with a TPC/RDC sensor. ◀

On motorcycles equipped with TPC/RDC, a corresponding label can be found on the rim at the position of the TPC/RDC sensor. When changing tires, ensure that the TPC/RDC sensor is not

damaged. Inform the authorized BMW Motorrad retailer or the specialist workshop about the TPC/RDC sensor.

Removing front wheel

- Place motorcycle on an auxiliary stand; BMW Motorrad recommends BMW Motorrad rear-wheel stand.
- Mounting rear-wheel stands (▶ 160).
– with center stand^{OE}
- Make sure ground is level and firm and place motorcycle on its center stand. ◀

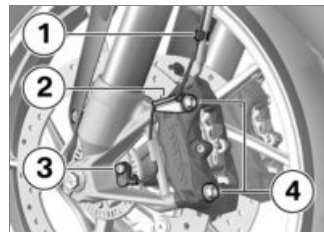

- Detach wheel speed sensor lead from retaining clips **1** and **2**.
- Remove screw **3** and take wheel speed sensor out of bore.
- Mask off areas of wheel rim that could be scratched in the process of removing the brake calipers.



ATTENTION

Unintentional pressing together of brake pads

Component damage when mounting the brake caliper or

when pressing the brake pads apart

- Do not actuate the brakes with the brake caliper removed.◀
- Remove securing screws **4** of left and right brake calipers.



- Push brake pads **1** slightly apart by turning the brake caliper **2** back and forth against the brake rotor **3**.
- Carefully pull brake calipers back and outward to remove them from the brake rotors.

- Raise front of motorcycle, preferably using a BMW Motorrad front wheel stand, continuing until the wheel rotates freely.
- Mount front wheel stand (▶▶ 159).



- Loosen axle clamping screws **1**.

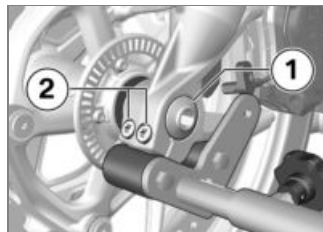

- Remove the screw **1**.
- Loosen axle clamping screws **2**.
- Slightly press the quick-release axle inward for a better grip on the right side.

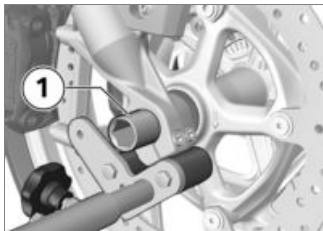

- Pull quick-release axle **1** out while supporting the front wheel.
- Place front wheel down and roll it forward out of the front suspension.

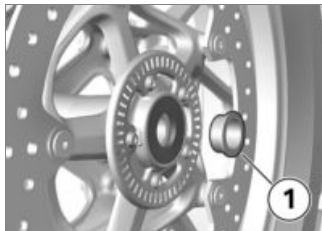

- Remove spacer bushing **1** from the wheel hub.

Installing front wheel

WARNING

Use of a wheel which does not comply with series specifications

Malfunctions during control interventions by ABS and ASC/DTC

- Please see the information on the effect of wheel sizes on the ABS and ASC/DTC chassis control systems at the beginning of this chapter. ◀

ATTENTION

Tightening of screwed connections with incorrect tightening torque

Damage or loosening of screwed connections

- Always have the tightening torques checked by a specialized workshop, preferably an authorized BMW Motorrad retailer. ◀

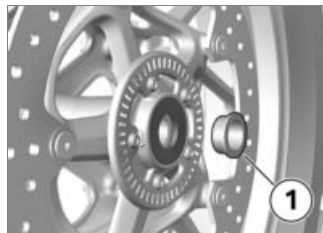

- Mount spacing bushing **1** on left side in wheel hub.

ATTENTION

Front wheel installation opposite the running direction

Accident hazard

- Observe running direction arrows on tire or rim. ◀
- Roll front wheel into front suspension.

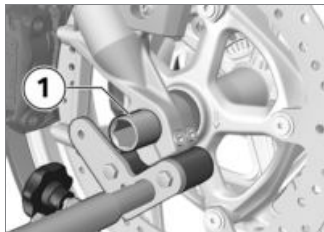

- Lift front wheel and install quick-release axle **1**.
- Remove front wheel stand and firmly compress front forks. Do not actuate handbrake lever at the same time.

- Mount front wheel stand (▶▶▶ 159).

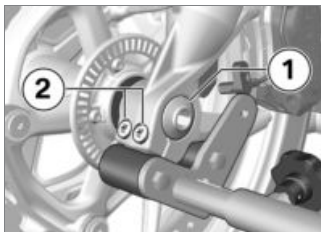

- Install screw **1** with specified torque. Brace quick-release axle on the right side at the same time.

 Clamping screw in telescopic fork

37 lb/ft (50 Nm)

- Tighten axle clamping screws **2** to appropriate torque.



 Clamping screw in axle adapter

Tightening sequence: Tighten the screws 6 times, alternating between one and the other each time

14 lb/ft (19 Nm)



- Tighten axle clamping screws **1** to appropriate torque.

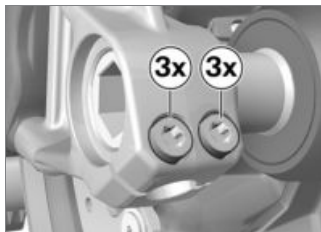

 Clamping screw in axle adapter

Tightening sequence: Tighten the screws 6 times, alternating between one and the other each time

14 lb/ft (19 Nm)

- Remove front wheel stand.
- Slide the brake calipers on the left-hand and right-hand side onto the brake rotors.

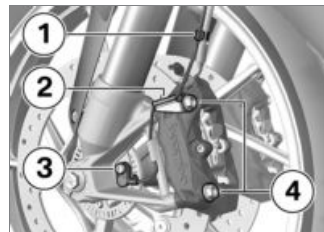

- Install mounting bolts **4** on left and right with appropriate torque.

 Brake caliper on telescopic forks

28 lb/ft (38 Nm)

- Remove adhesive tape from wheel rim

WARNING

Brake pads do not contact the brake disc

Risk of accident due to delayed braking effect.

- Before driving off, check that the braking effect kicks in without any delay.◀
- Engage the brakes repeatedly, continuing until the brake pads seat against the rotors.
- Insert the wheel speed sensor cable into the holding clips **1** and **2**.
- Insert the wheel speed sensor into the bore and install screw **3**.

 Wheel speed sensor on fork

Joint compound: Micro-encapsulated or medium-strength screw lock

 Wheel speed sensor on fork

6 lb/ft (8 Nm)

Removing rear wheel

- Removing the silencer (→ 176).



- Shift into first gear.
- Remove bolts **1** of rear wheel, holding wheel as you do so.
- Roll rear wheel out toward rear.

Installing rear wheel

WARNING

Use of a wheel which does not comply with series specifications

Malfunctions during control interventions by ABS and ASC/DTC

- Please see the information on the effect of wheel sizes on the ABS and ASC/DTC chassis control systems at the beginning of this chapter.◀

ATTENTION

Tightening of screwed connections with incorrect tightening torque

Damage or loosening of screwed connections

- Always have the tightening torques checked by a specialized workshop, preferably an authorized BMW Motorrad retailer.◀

- Place rear wheel on rear wheel support.



- Install wheel studs **1** with specified torque.



Tighten rear wheel on wheel flange

Tightening sequence: Tighten crosswise

44 lb/ft (60 Nm)

- Installing the silencer (➡ 177).

Muffler

Removing the silencer



CAUTION

Hot exhaust system

Burn hazard

- Do not touch hot exhaust system. ◀
- Let rear muffler cool down.
- Make sure ground is level and firm and place motorcycle on a suitable auxiliary stand. BMW Motorrad recommends the BMW Motorrad rear-wheel stand.
- Mounting rear-wheel stands (➡ 160).
 - with center stand^{OE}
- Make sure the ground is level and firm and place the motorcycle on its center stand. ◀

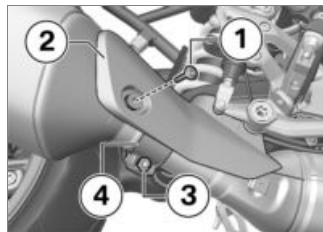

- Remove screw **1** from cover **2**.
- Remove screw **3** from circlip **4**.

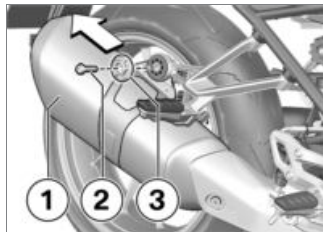

- Remove screw **2** and shim **3**.
- Remove silencer **1**.

Installing the silencer

ATTENTION

Tightening of screwed connections with incorrect tightening torque

Damage or loosening of screwed connections

- Always have the tightening torques checked by a specialized workshop, preferably an authorized BMW Motorrad retailer. ◀

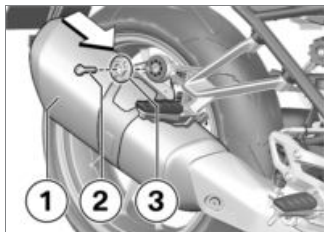

- Push the circlip onto the silencer.

- Push silencer **1** up to the stop.
- Install screw **2** and shim **3**.

 Muffler on rear frame

14 lb/ft (19 Nm)

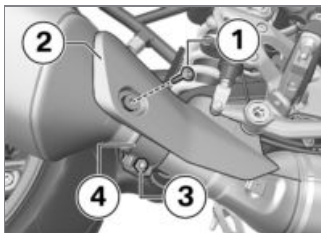

- Tighten nut **3** of circlip **4**.

 Clamp on silencer and exhaust manifold

18 lb/ft (24 Nm)

- Install screw **2** of cover **1**.

Air filter

Replace air filter insert

- Remove rider's seat (▶▶▶ 86).



- Remove screws **1**.

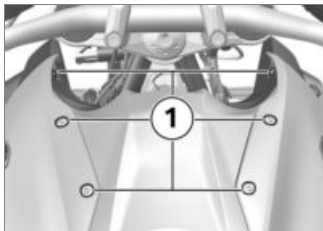

- Remove the screws **1** and move both side trim panels slightly apart.

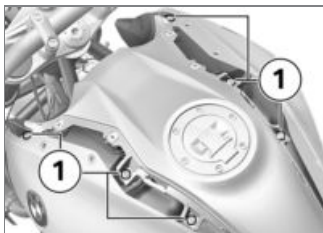

- Remove screws **1**.
- Remove center fairing panel.



- Remove screws **1**.
- Remove air filter cover.



- Remove frame **2**.
- Remove air filter insert **1**.

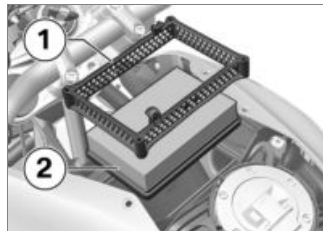

- Clean air filter element **2** or replace, if necessary.
- Insert air filter element **2** and frame **1**.



- Lay on air filter cover.
- Install screws **1**.

- Position the center fairing panel, while paying attention to connections to the side sections.

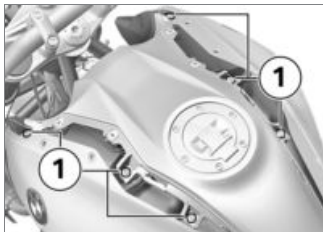

- Install screws **1**.



- Install screws **1**.

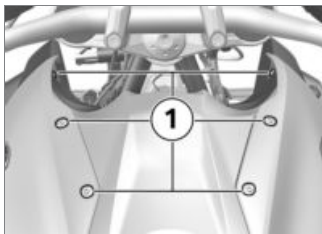

- Install screws **1**.
- Installing driver's seat (➡ 86).

Light sources

Replacing front and rear turn indicator light sources

- Park motorcycle, ensuring that support surface is firm and level.
- Switch off ignition.



- Remove the screw **1**.



- Remove the lens from the housing by pulling it outward on the side with the screw.

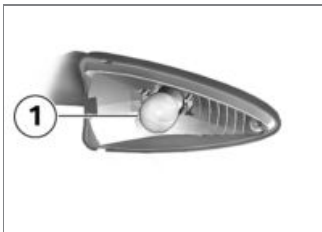

- To prevent contaminants from being deposited on the glass

surface, always use a clean, dry cloth to hold the light source.

- Remove bulb **1** from light housing by turning it counterclockwise.
- Replace defective light source.



Bulbs for flashing turn indicators, front

RY10W / 12 V / 10 W



Bulbs for flashing turn indicators, rear

RY10W / 12 V / 10 W

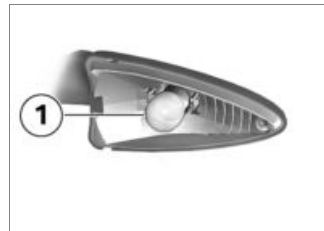

- Install light source **1** by turning clockwise in light housing.



- Insert inside end of lens into light housing and close it.



- Install screw **1**.

Replacing LED tail light

The LED tail light can only be completely replaced.

- For details please contact a specialist service facility, preferably an authorized BMW Motorrad Dealer.

Replace LED headlights

- LED headlights can only be replaced as a complete unit. For details please contact a specialist service facility, preferably an authorized BMW Motorrad Retailer.

Replace additional LED headlight

– with LED additional headlight^{OA}

The LED additional headlights can only be completely replaced; it is not possible to replace individual LEDs.

Please contact a specialist service facility, preferably an authorized BMW Motorrad retailer.

Jump-starting



Current too high when jump-starting the motorcycle

Cable fire or damage to the motorcycle electronics

- Do not jump-start the motorcycle using the power socket, only via the battery terminal.◀



ATTENTION

Contact between crocodile clips of jump leads and motorcycle

Danger of short circuit

- Use jump leads fitted with fully insulated crocodile clips at both ends.◀



ATTENTION

Jump-starting with a voltage higher than 12 V

Damage to the motorcycle's electronics

- The battery of the donor motorcycle must have a voltage of 12 V.◀
- Park motorcycle, ensuring that support surface is firm and level.
- Remove battery cover (▣► 184).
- Do not disconnect the battery from the onboard electrical sys-

tem when jump-starting the engine.

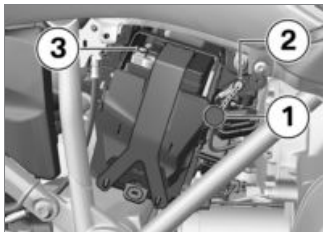

- Remove the protective cap **1**.
- Begin by connecting one end of the red jumper cable to the auxiliary terminal for jump starting **2** on the discharged battery and the other end to the positive terminal of the donor battery.
- Connect black jumper cable to negative terminal on donor battery and then to negative terminal **3** of discharged battery.

- Run engine of donor motorcycle during jump-starting procedure.
- Start engine of motorcycle with discharged battery in usual way; if engine does not start, wait a few minutes before repeating attempt in order to protect starter motor and donor battery.
- Allow both engines to idle for a few minutes before disconnecting jumper cables.
- Disconnect jumper cable from negative terminals first, then disconnect second cable from positive terminals.



NOTICE

To start the engine, do not use start sprays or similar items. ◀

- Install the protective cap.
- Installing battery cover (▶▶▶ 186).

Battery

Maintenance instructions

Correct battery maintenance combined with proper charging and storage procedures extends the battery's service life, and is also required for warranty claims. Compliance with the points below is important in order to maximize battery life:

- Keep the surface of the battery clean and dry.
- Do not open the battery.
- Do not top up with water.
- Be sure to read and comply with the instructions for charging the battery on the following pages.
- Do not turn the battery upside down.

 **ATTENTION****Discharging of the connected battery by the vehicle electronics (e.g. clock)**

Total discharge of battery leading to a rejection of warranty claims

- During riding breaks of more than 4 weeks, connect a trickle-charger to the battery.◀

 **NOTICE**

BMW Motorrad has developed a trickle-charger specially designed for compatibility with the electronics of your motorcycle. Using this charger, you can keep the battery charged during long periods when the motorcycle is not being used without having to disconnect the battery from the motorcycle's onboard systems. Additional information is available at your authorized BMW Motorrad retailer.◀

Charge connected battery **ATTENTION****Charging the battery connected to the vehicle using the battery terminals**

Damage to the motorcycle's electronics

- Disconnect the battery before charging on the battery terminals.◀

 **ATTENTION****A fully discharged battery must be charged via a power socket or extra socket.**

Damage to vehicle electronics

- A fully discharged battery (battery voltage less than 12 V, indicator lights and multifunction display remain off when ignition is switched on) must always be charged directly at the poles of the **disconnected** battery.◀

 **ATTENTION****Unsuitable chargers connected to the power socket**

Damage to charger and vehicle electronics

- Use suitable BMW chargers. The correct charger is available through your authorized BMW Motorrad retailer.◀
- Charge disconnected battery via onboard socket.

 **NOTICE**

The motorcycle's onboard electronics know when the battery is fully charged. The onboard socket is switched off when this happens.◀

- Comply with operating instructions of charger.

NOTICE

If you are unable to charge the battery via the onboard socket, you may be using a charger that is not compatible with your motorcycle's electronics. In this case, charge the battery directly from the terminals of the battery disconnected from the vehicle.◀

Charging disconnected battery

- Charge battery using a suitable charger.
- Comply with operating instructions of charger.
- Once battery is fully charged, disconnect charger's terminal clips from battery terminals.

NOTICE

In the case of longer periods when the motorcycle is not being used, the battery must be

recharged regularly. See the instructions for caring for your battery. Always fully recharge the battery before returning it to use.◀

Removing battery

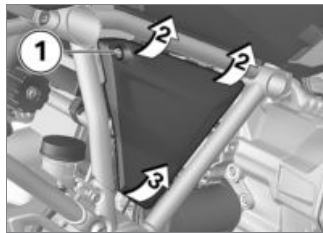

- Switch off ignition.
- Remove screw **1**.
- Pull battery cover at top slightly forward at the positions **2**.
- In order not to damage the battery cover and the mount, remove the battery cover upward at position **3**.

- with anti-theft alarm system (DWA)^{OE}
- Switch off anti-theft alarm system if necessary.◀



- Remove negative battery cable **1** and rubber strap **2**.



- Pull mounting plate on position **1** outward and remove it upward.
- Lift battery slightly out of holder sufficiently for positive terminal to be accessible.



- Remove positive battery cable **1** and pull out battery.

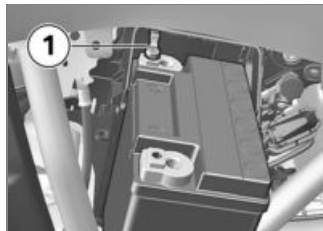

- Fasten positive battery cable **1**.
- Slide battery into holder.

Install battery



If the 12-V battery is inserted incorrectly or the terminals reversed (e.g. when jump starting), it can blow the fuse for the alternator regulator. ◀

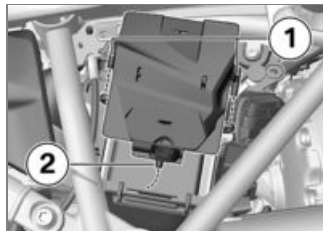

- First, insert mounting plate into supports **1**. Next, press it under the battery at position **2**.

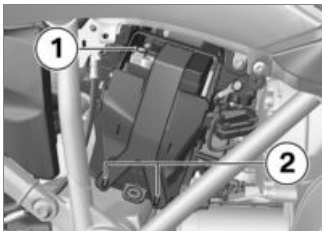

- Fasten negative battery cable **1**.
- Fasten battery with rubber strap **2**.



- Fit the screw **1**.
- Set clock (▣▣▣ 97).
- Set date (▣▣▣ 97).

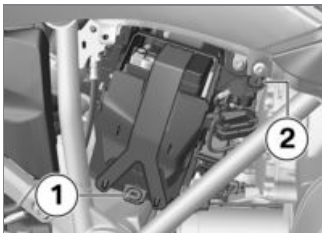

- Insert the battery cover into mount **1** and press it into mount **2**.

Fuses

Replacing fuses

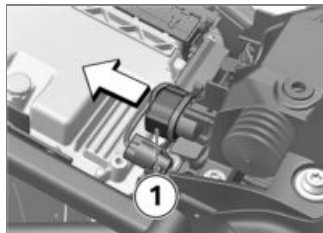

- Switch off ignition.
- Remove rider's seat (▣▣▣ 86).
- Detach plug **1**.



ATTENTION

Bypassing defective fuses

Risk of short circuit and fire

- Do not bypass defective fuses.
- Replace defective fuses with new fuses.◀
- Consult the fuse assignment diagram and replace the defective fuse.



NOTICE

If the fuses blow frequently, have the electrical system checked by an authorized specialized workshop, preferably an authorized BMW Motorrad retailer. ◀

- Insert connector **1**.
- Installing driver's seat (▶▶ 86).

Fuse assignments

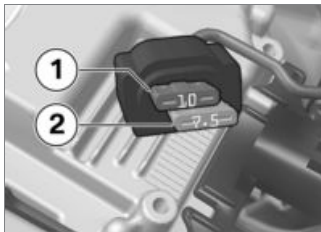

- 1** 10 A
Instrument cluster
Anti-theft alarm system (DWA)
Ignition switch
Diagnostic socket
- 2** 7.5 A
Multifunction switch, left
Tire Pressure Monitor (TPM)

Fuse for the alternator regulator

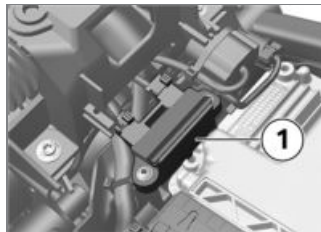

- 1** 50 A
Alternator regulator

Data link connector

Removing the diagnostic connector

CAUTION

Incorrect procedure followed when disconnecting the data link connector for the On-Board Diagnostics.

Motorcycle experiences malfunctions

- Only have the data link connector disconnected by a specialist workshop or other authorized persons during your next BMW Service appointment.
- Have the work performed by appropriately trained staff.
- Refer to the vehicle manufacturer specifications. ◀
- Remove battery cover (➡ 184).



- Push on hook **1** and pull data link connector **2** up and out.

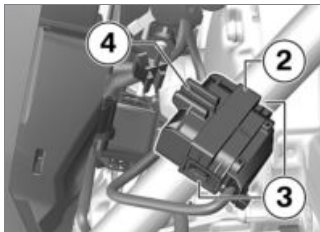

- Press locks **3** on both sides.
- Remove data link connector **2** from bracket **4**.
- » The diagnosis and information system interface can be con-

nected at the diagnostic connector **2**.

Secure the data link connector

- Disconnect the diagnosis and information system interface.

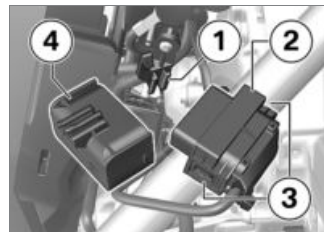

- Insert data link connector **2** into bracket **4**.
- » Locks **3** engage on both sides.
- Mount bracket **4** onto fixture **1**.



- Make sure that hook **5** engages.
- Installing battery cover (▶▶▶ 186).

Accessories

General notes.....	192
Onboard power sockets	192
Case.....	193
Topcase	195
Navigation system	198

General notes

CAUTION

Use of products from other manufacturers

Safety risk

- BMW Motorrad cannot examine or test each product of outside origin to ensure that it can be used on or in connection with BMW motorcycles without constituting a safety hazard. Nor is this guarantee provided when the official approval of a specific country has been granted. Tests conducted by these instances cannot make provision for all operating conditions experienced by BMW motorcycles and, consequently, they are not sufficient in some circumstances.
- Use only parts and accessories approved by BMW for your motorcycle. ◀

The safety, operation and suitability of the parts and accessory products have been thoroughly checked by BMW. Therefore, BMW assumes responsibility for these products. BMW will not be held liable for unapproved parts and accessory products of any kind.

Comply with legal requirements for any modifications. The motorcycle must not violate the regulations governing motorcycle approval for highway use applicable in your own country.

Your BMW Motorrad retailer offers you expert advice when choosing genuine BMW parts, accessories and other products. More information on the topic of accessories is available at:

bmw-motorrad.com/equipment

Onboard power sockets

Connection of electrical devices

- The ignition must be switched on before electrical devices connected to the power sockets can be operated.

Cable routing

- The cables from the onboard sockets to the auxiliary devices must be routed in such a way that they do not impede the rider.
- Cable routing must not restrict the steering angle and the handling characteristics.
- Cables must not be trapped.

Automatic deactivation

- The onboard sockets are automatically switched off during starting.
- These sockets are switched off approx. 15 minutes after

switching off the ignition to reduce the strain on the onboard electrical system. Additional devices with low power consumption are possibly not detected by the vehicle electronics. In these cases, onboard sockets are already switched off shortly after the ignition is switched off.

- In case of insufficient battery voltage, the onboard sockets are switched off to maintain the ability to start the motorcycle.
- If the maximum loadability specified in the technical data is exceeded, the onboard sockets are switched off.

Case

- with touring case^{OA}

Open case

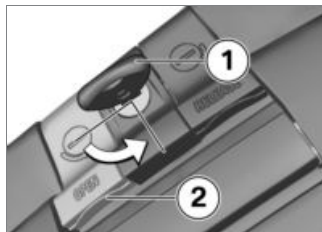

- Turn key **1** to position **OPEN**.
- Pull gray release lever **2** (**OPEN**) upward and simultaneously open case lid.

Close case



- Turn key **1** to position **OPEN**.
- Press catches **2** of case lid into retainers **3**. Ensure that no objects are trapped between cover and case.
- Pull gray release lever **4** (**OPEN**) upward and simultaneously close case lid.
- » The lid clicks audibly into place.
- Turn key **1** in case lock in the direction of travel and remove.

Remove case

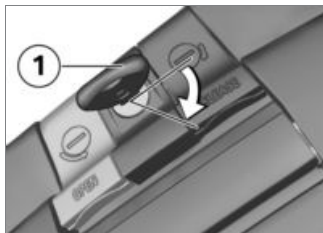

- Turn key **1** to position RE-LEASE.



- Pull black release lever **1** (RE-LEASE) upward while simulta-

neously pulling the case outward.

- Then lift case out of lower mounting.

Mounting case

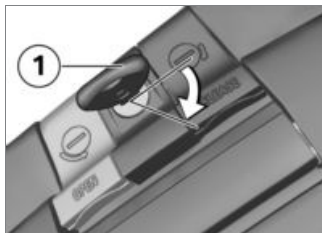

- Turn key **1** to position RE-LEASE.

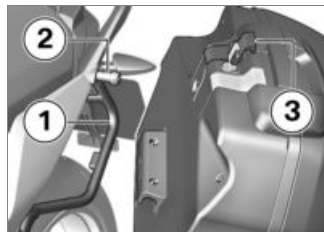

- Insert case in case carrier **1**, then swing as far as possible onto mount **2**.
- Pull black release lever **3** (RE-LEASE) upward while simultaneously pushing the case into upper mount **2**.
- Press black release lever **3** (RELEASE) down until it engages.
- Turn key in case lock in the direction of travel and remove.

Maximum payload and top speed

Note the maximum permissible payload and the speed limit for riding with cases fitted, as stated on the label inside the case.

If you cannot find your combination of vehicle and case on the sign, contact your BMW Motorrad partner.

The following values apply for the combination described here:



Maximum speed for riding with case

max 112 mph (max 180 km/h)



Payload per case

max 22 lbs (max 10 kg)

Secure hold



If a case wobbles or is difficult to fit, it must be adapted to the gap between the upper and lower mount.

WARNING

Improperly installed case.

Impairment of riding safety.

- Cases may not shake and must be fastened play-free. If some play is determined after longer use, readjust the retaining claw. ◀



Use the screws **1** inside the case for this purpose.

Topcase

Opening the topcase

– with topcase^{OA}



- Turn the key in the topcase lock to position **1**.



- Press the lock cylinder **1** to the front.
- » The release lever **2** pops up.

- Pull release lever all the way up.
- » The topcase lid can be opened.

Close topcase

- with topcase^{OA}



- Pull release lever **1** all the way up.
- Close topcase lid and hold it down. Ensure that no items are trapped between cover and case.



NOTICE

The Topcase can also be locked if the lock is in the LOCK position. Under such circumstances, ensure that the key is not in the Topcase. ◀



- Press release lever **1** down until it engages.
- Turn key in topcase lock into LOCK position and remove.

Remove topcase

– with topcase^{OA}



- Turn key in Topcase lock into Position **1**.
- » Handle pops out.



- Fold handle **1** all the way up.
- Raise the rear of the topcase and pull it off luggage rack.

Mounting topcase

– with topcase^{OA}



WARNING

Topcase not properly secured

Driving safety is impaired

- Topcase must not shake and must be fastened clearance-free.◀

- Fold up handle as far as possible.



- Hook topcase into luggage rack. Make sure that hooks **1** engage securely in their mounts **2**.



- Press handle **1** down until it engages.



- Turn key in Topcase lock into Position **1** and remove.

Maximum payload and top speed

– with topcase^{OA}

Note the maximum permissible payload and the speed limit for riding with topcase fitted, as stated on the label inside the topcase.

If you cannot find your combination of motorcycle and topcase on the sign, contact your authorized BMW Motorrad retailer.

The following values apply for the combination described here:

	Maximum speed when riding with loaded Vario topcase
---	---

max 112 mph (max 180 km/h)

	Payload of Vario topcase
---	--------------------------

max 11 lbs (max 5 kg)

Navigation system

Fasten navigation system securely

- with preparation for navigation system^{OE}
- with navigation system^{OA}

NOTICE

The navigation preparation is suitable as from the BMW Motorrad Navigator IV. ◀

NOTICE

The locking system of the Mount Cradle offers no protection against theft. Remove the navigation system and store in a safe place after every drive. ◀

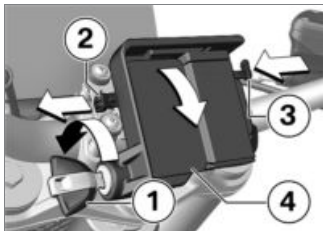

- Turn the ignition key **1** counterclockwise.
- Pull the shut-off lock **2** to the **left**.
- Press in the locking mechanism **3**.
 - » The Mount Cradle is unlocked and the cover **4** can be removed with a rotational movement toward the front.

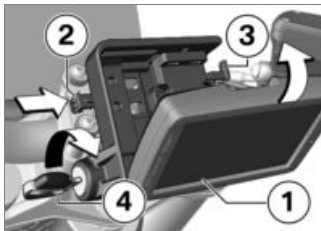

- Mount the navigation system **1** in the lower area and swing backward with a rotational movement.
 - » Navigation system audibly engages.
- Slide the shut-off lock **2** completely to the **right**.
 - » The locking mechanism **3** is locked.
- Turn the ignition key **4** clockwise.
 - » Navigation system is locked and ignition key can be removed.

Remove navigation system and install cover

- with preparation for navigation system^{OE}
- with navigation system^{OA}



ATTENTION

Dust and dirt on the contacts of the Mount Cradle

Damage to the contacts

- Reinstall the cover after end of each drive. ◀

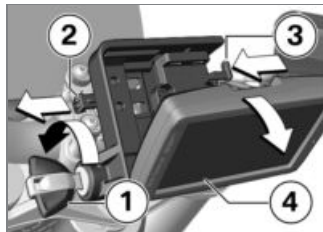

- Turn the ignition key **1** counterclockwise.

- Pull the shut-off lock **2** completely to the **left**.
 - » The locking mechanism **3** is unlocked.
- Slide the locking mechanism **3** completely to the **left**.
 - » The navigation system **4** will be unlocked.
- Remove the navigation system **4** downward with a tilting movement.

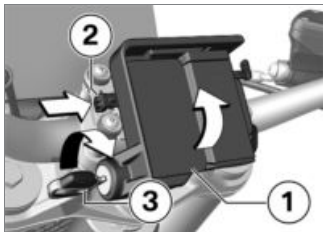

- Mount the cover **1** in the lower area and swing upward with a rotational movement.
 - » Cover audibly engages.

- Slide the shut-off lock **2** to the **right**.
- Turn the ignition key **3** clockwise.
 - » The cover **1** is secured.

Operating the navigation system

– with preparation for navigation system^{OE}



NOTICE

The following description refers to the BMW Motorrad Navigator V and the BMW Motorrad Navigator VI. The BMW Motorrad Navigator IV does not offer all options described. ◀



NOTICE

Only the latest version of the BMW Motorrad communication system is supported. A software update may be required

for the BMW Motorrad communication system. In this case, please contact your authorized BMW Motorrad retailer. ◀

If the BMW Motorrad Navigator is installed and the operating focus is changed to the Navigator (➡ 93), some of its functions can be operated directly from the handlebars.

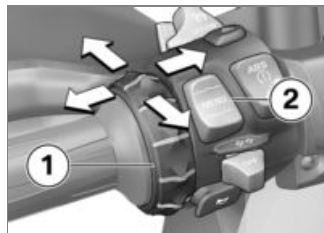

The navigation system is operated using the Multi-Controller **1** and the rocker button MENU **2**.

Turning the Multi-Controller 1 up and down

On the compass and Mediaplayer pages: increase or reduce the volume for a BMW Motorrad communication system connected via Bluetooth. On the BMW special menu: select menu items.

Briefly tilting the Multi-Controller 1 to the left and right

Change between the main pages of the Navigator:

- Map view
- Compass
- Mediaplayer
- BMW special menu
- My motorcycle page

Long-tilting the Multi-Controller 1 to the left and right

Activate certain functions on the Navigator display. These func-

tions are marked with a right arrow or a left arrow above the corresponding touch field.



The function is triggered by long actuation to the right.



The function is triggered by long actuation to the left.

Pressing the bottom rocker button MENU 2

Change the operating focus to the Pure Ride view.

In detail, the following functions can be operated:

Map view

- Turning upward: zooms in on map section (Zoom in).
- Turn downward: zooms out of map section (Zoom out).

Compass page

- Turning increases or reduces volume of a BMW Motorrad communication system connected via Bluetooth.

BMW special menu

- Speak: Repeat last navigation announcement.
- Way point: Save current way point as favorite.
- Navigate home: Starts navigation to the home address (is grayed-out if no home address is set).
- Mute: Switch automatic navigation announcements (off: the top line in the display shows a crossed-out lip icon). Navigation announcements can still be output via "Speak". All other sound outputs remain switched on.
- Switching off display: Switch off display.

- Call home: Calls the home phone number stored in the navigator (only displayed when a communication system and a phone are connected).
- Detour: Activates the detour function (only displayed if a route is active).
- Skip: Skips the next way point (only displayed if route is provided with way points).

My Motorcycle

- Turn: Changes the number of data displayed.
- Touching a data field on the display opens a menu for selecting the data.
- The values available for selection are dependent on the optional extras installed.

Medioplayer

- Long actuation to left: Play previous title.

- Long actuation to right: Play next title.
- Turning increases or reduces volume of a BMW Motorrad communication system connected via Bluetooth.



NOTICE

The Medioplayer function is only available when using a Bluetooth device as per A2DP standard, e.g., a BMW Motorrad communication system. ◀

Warning and status messages

- with navigation system^{OA}



Warning and status displays of the motorcycle are indicated with a corresponding icon **1** at the upper left on the map view.



NOTICE

If a BMW Motorrad communication system is connected, an acoustic signal is also sounds in case of a warning. ◀

If several warning messages are active, the number of messages is indicated below the warning triangle.

A list of all warning messages is opened by pressing on the

warning triangle with more than one message.

Additional information is displayed when a message is selected.



NOTICE

Detailed information cannot be displayed for all warnings. ◀

Special functions

– with preparation for navigation system^{OE}

Due to integration of the BMW Motorrad Navigator there are differences from the descriptions in the instruction manual for the Navigator.

Reserve fuel level warning

The settings for the fuel gauge are not available because the reserve warning is transmitted from the vehicle to the Navigator. If the message is active, the nearest

gas stations are shown when you press on the message.

Time and date display

The Navigator transmits the time and date to the motorcycle. To transfer the time to the TFT display, the *GPS synchronization* function must also be activated in the *Settings, System settings, Date and time* menu.

Security settings

The BMW Motorrad Navigator V and the BMW Motorrad Navigator VI can be secured against unauthorized use with a four-digit PIN (Garmin Lock). When this function is activated, once the Navigator GPS receiver is cradled on the motorcycle and the ignition is switched on you will receive a prompt asking whether the motorcycle should be added to the list of secure vehicles. If

you confirm this question by answering "yes", then the Navigator will save the vehicle identification number of this vehicle.

A maximum of five VINs can be saved in this way.

A PIN entry will no longer be required when this Navigator is activated by turning on the ignition switch in any of these vehicles.

Removing the Navigator from the motorcycle while it is switched on will launch a new PIN request as a security measure.

Screen brightness

Screen brightness is adjusted by the motorcycle while the unit is cradled. There is no need for manual input.

If desired, automatic setting can be switched off in the Navigator via the display settings.

Care

Care products	206
Washing your motorcycle	206
Cleaning sensitive motorcycle parts	207
Paint care	208
Protective wax coating	208
Store motorcycle	208
Return motorcycle to use	209

Care products

BMW Motorrad recommends that you use cleaning and care products available at your authorized BMW Motorrad retailer. BMW Care Products have been materials tested, laboratory tested, and field tested and provide optimum care and protection for the materials used in your vehicle.

ATTENTION

Use of unsuitable cleaning and care agents

Damage to motorcycle parts

- Do not use any solvents such as nitro thinners, cold cleaners, fuel or similar, and do not use cleaning agents that contain alcohol. ◀

ATTENTION

Use of highly acidic or alkaline cleaning agents

Damage to motorcycle parts

- Observe the dilution ratio on the packaging of the cleaning agents.
- Do not use highly acidic or alkaline cleaning agents. ◀

Washing your motorcycle

BMW Motorrad recommends that you use BMW Insect Remover to soften and wash off insects and stubborn dirt from painted parts before washing the motorcycle.

To prevent stains, do not wash the motorcycle immediately after it has been exposed to bright sunlight and do not wash it in the sun.

Make sure that the motorcycle is washed frequently, especially during the winter months. To remove road salt, clean the motorcycle with cold water immediately after completion of every trip.

WARNING

Damp brake disks and brake pads after washing the motorcycle, after riding through water or in the rain

Poorer braking action, accident hazard

- Brake early until the brake rotors and brake pads are dry. ◀

ATTENTION

Increased effect of salt caused by warm water

Corrosion

- Only use cold water to remove road salt. ◀



ATTENTION

Damage caused by high water pressure from high-pressure cleaners or steam-jet devices

Corrosion or short circuit, damage to labels, to seals, to hydraulic brake system, to the electrical system and the seat

- Exercise caution when using high-pressure or steam-jet devices. ◀

Cleaning sensitive motorcycle parts

Plastics



ATTENTION

Use of unsuitable cleaning agents

Damage to plastic surfaces

- Do not use abrasive cleaners or cleaners containing alcohol or solvents.
- Do not use insect sponges or sponges with a hard surface. ◀

Fairings and panels

Clean trim panel components with water and BMW Motorrad solvent cleaner.

Windshields and lenses are manufactured in plastic

Clean off dirt and insects with a soft sponge and plenty of water.



NOTICE

Soften stubborn dirt and dead insects by covering the affected areas with a wet cloth. ◀



Clean with water and sponge only.



Do not use chemical cleansers.

TFT display

Clean the TFT display with warm water and detergent. Then dry with a clean cloth, e.g. a paper towel.

Chrome

Carefully clean chrome parts with plenty of water and BMW Motorrad Care Products motorcycle cleaner. This is particularly important in the case of road salt.

Use BMW Motorrad metal polish for additional treatment.

Radiator

Clean the radiator regularly to prevent overheating of the engine due to inadequate cooling. For example, use a garden hose with low water pressure.

**ATTENTION****Bending of radiator fins**

Damage to radiator fins

- When cleaning, ensure that the cooler fins are not bent. ◀

Rubber

Treat rubber components with water or BMW rubber protection coating agent.

**ATTENTION****Use of silicone sprays for care of rubber seals**

Damage to rubber seals

- Do not use silicone sprays or care products that contain silicone. ◀

Paint care

Washing the motorcycle regularly will help counteract the long-term effects of substances that damage the paint, especially if

your motorcycle is ridden in areas with high air pollution or natural sources of dirt, such as tree resin or pollen.

At the same time, you should remove particularly aggressive materials immediately; otherwise changes in the paint and discoloration can occur. These include spilled fuel, oil, grease and brake fluid as well as bird droppings. It is recommended to use BMW Motorrad solvent cleaner and then apply BMW Motorrad high gloss polish to preserve the paint.

Contamination on the paint finish is particularly easy to see after the motorcycle has been washed. Remove this type of soiling with cleaning naphtha or spirit on a clean cloth or cotton ball. BMW Motorrad recommends removing tar stains with BMW tar remover. Then add

a protective wax coating to the paint at these locations.

Protective wax coating

Apply a preservative when water fails to bead up on the painted surface.

BMW Motorrad recommends BMW Motorrad high gloss polish or agents that contain carnauba or synthetic wax to protect the paint finish.

Store motorcycle

- Clean motorcycle.
- Completely fill the motorcycle's fuel tank.
- Removing battery (▶▶ 184).
- Spray the brake and clutch lever, and the center and side stand pivots with a suitable lubricant.

- Protect metal and chrome-plated parts with an acid-free grease (Vaseline).
- Store the motorcycle in a dry room, raising it to remove the weight from both front wheels (preferably using the front and rear-wheel stands offered by BMW Motorrad).

Return motorcycle to use

- Remove the protective wax coating.
- Clean motorcycle.
- Install battery (▣▶ 185).
- Observe checklist (▣▶ 126).

Technical data

Troubleshooting chart	212
Threaded fasteners	215
Fuel.....	218
Engine oil	219
Engine	219
Clutch	220
Transmission	220
Rear-wheel drive.....	221
Frame	221
Suspension	222
Brakes	223
Wheels and tires	223
Electrical system.....	225
Anti-theft alarm system	226
Dimensions	227

Weights.....	228
Performance data	228

Bluetooth connection is not established.

Possible cause

Remedy

Necessary pairing steps were not performed.

Refer to the operating instructions of the communication system for the necessary steps for pairing.

The communication system is not connected automatically despite successful pairing.

Switch off the communication system of the helmet and connect again after one to two minutes.

Too many Bluetooth devices are stored in the helmet.

Delete all pairing entries in the helmet (see the operating instructions of the communication system).

There are additional vehicles with Bluetooth-capable devices nearby.

Avoid simultaneous pairing with multiple vehicles.

Bluetooth connection is disrupted.

Possible cause

Remedy

Bluetooth connection to the mobile end device is interrupted.

Switch off energy saving mode.

Bluetooth connection to the helmet is interrupted.

Switch off the communication system of the helmet and connect again after one to two minutes.

Volume in the helmet cannot be adjusted.

Switch off the communication system of the helmet and connect again after one to two minutes.

Threaded fasteners

Front wheel	Value	Valid
Brake caliper on telescopic forks		
M10 x 65	28 lb/ft (38 Nm)	
Quick-release axle in telescopic fork		
M20 x 1.5	37 lb/ft (50 Nm)	
Clamping screw in axle adapter		
M8 x 35	Tightening sequence: Tighten the screws 6 times, alternating between one and the other each time	
	14 lb/ft (19 Nm)	
Rear wheel	Value	Valid
Tighten rear wheel on wheel flange		
M10 x 1.25 x 40	Tightening sequence: Tighten cross-wise	
	44 lb/ft (60 Nm)	

Mirror arm	Value	Valid
Mirror (locknut) on adapter		
M10 x 1.25	Left-hand thread, 16 lb/ft (22 Nm)	
Adapter to clamping block		
M10 x 14 - 4.8	18 lb/ft (25 Nm)	
Gearshift lever	Value	Valid
Foot piece to gearshift lever		
M6 x 20 micro-encapsulated	7 lb/ft (10 Nm)	
Footbrake lever	Value	Valid
Foot piece on footbrake lever		
M6 x 20 micro-encapsulated	7 lb/ft (10 Nm)	
Footrests	Value	Valid
Clamping block on footrest hinge		
M8 x 25	15 lb/ft (20 Nm)	

Footrests	Value	Valid
Footrest on clamping block		
M6 x 20 / M6 x 12	7 lb/ft (10 Nm)	
Handlebars	Value	Valid
Clamping block (handlebar clamp) to fork bridge		
M8 x 35	Tightening sequence: tighten to block at front in direction of travel	
	14 lb/ft (19 Nm)	
M8 x 30	Tightening sequence: tighten to block at front in direction of travel	– with preparation for navigation system ^{OE}
	14 lb/ft (19 Nm)	

Fuel

Recommended fuel quality	Super unleaded (max 15% ethanol, E0/E5/E10/E15) 89 AKI (95 ROZ/RON) 90 AKI
Alternative fuel quality	Regular unleaded (restrictions with regard to power and fuel consumption). (max 15% ethanol, E0/E5/E10/E15) 87 AKI (91 ROZ/RON) 87 AKI
Usable fuel quantity	Approx. 4.8 gal (Approx. 18 l)
Reserve fuel quantity	Approx. 1.1 gal (Approx. 4 l)
Fuel consumption	50 mpg (4.75 l/100 km)
CO2 emissions	110 g/km, according to WMTC
Emission standard	EU4

Engine oil

Engine oil, capacity	max 1.1 gal (max 4 l), with filter replacement
Specification	SAE 5W-40, API SL/JASO MA2, Additives (for instance, molybdenum-based substances) are prohibited, because they would attack the coatings on engine components, BMW Motorrad recommends BMW Motorrad ADVANTEC Ultimate oil.
Engine oil, quantity for topping up	max 0.8 quarts (max 0.8 l), Difference between MIN and MAX

BMW recommends **ADVANTEC**
ORIGINAL BMW ENGINE OIL

Engine

Engine number location	Lower right of engine block beneath the starter
Engine type	A74B12M
Engine design	Air-cooled/liquid-cooled two-cylinder four-stroke opposed-twin engine with two overhead, spur-gear-driven camshafts, a counterbalance shaft, and variable intake camshaft control BMW Shift-Cam
Displacement	1254 cc (1254 cm ³)
Cylinder bore	4 in (102.5 mm)

Piston stroke	3 in (76 mm)
Compression ratio	12.5 g/cm ³
Rated output	136 hp (100 kW), at engine speed: 7750 min ⁻¹
Torque	105 lb/ft (143 Nm), at engine speed: 6250 min ⁻¹
Maximum engine speed	max 9000 min ⁻¹
Idle speed	1050 min ⁻¹ , Engine at operating temperature

Clutch

Clutch design	Multiple-disc oil bath (anti-hopping)
---------------	---------------------------------------

Transmission

Transmission design	Dog-engagement 6-speed transmission with helical gears
Transmission gear ratios	1.650 (33 : 20), Primary gear ratio 2.438 (39 : 16), 1st gear 1.714 (36 : 21), 2nd gear 1.296 (35 : 27), 3rd gear 1.059 (36 : 34), 4th gear 0.943 (33 : 35), 5th gear 0.848 (28 : 33), 6th gear 1.061 (35 : 33), Transmission output ratio

Rear-wheel drive

Type of final drive	Shaft drive with bevel gears
Type of rear suspension	Cast-aluminum single swing arm with BMW Motorrad Paralever
Gear ratio of final drive	2.818 (31/11 teeth)
Rear axle differential oil	SAE 70W-80 / hypoid axle G3

Frame

Frame design	Steel-tube frame with partially self-supporting drive unit, steel-tube rear frame
Location of type plate	Frame at front left on steering head
Location of the vehicle identification number	Frame at front right on steering head

Suspension

Front wheel

Type of front suspension	Upside-down telescopic forks
– with Dynamic ESA ^{OE}	Upside down telescopic forks, diameter 54 mm, adjustable rebound and compression stage
Spring travel, front	5.5 in (140 mm), on front wheel

Rear wheel

Type of rear suspension	Cast-aluminum single swing arm with BMW Motorrad Paralever
Type of rear suspension	Central spring strut with coil spring, adjustable rebound-stage damping and spring preload
– with Dynamic ESA ^{OE}	ESA-2 with spring rate adjustment
Spring travel at rear wheel	5.5 in (140 mm)

Brakes

Front wheel

Type of front brake	Hydraulically operated twin disk brake with 4-piston radial calipers and floating brake disks
Front brake pad material	Sintered metal

Rear wheel

Type of rear brake	Hydraulically operated disk brake with 2-piston floating caliper and fixed brake disk
Rear brake pad material	Sintered metal

Wheels and tires

Recommended tire combinations	An overview of the current tire approvals is available from your authorized BMW Motorrad retailer or on the Internet at bmw-motorrad.com .
Speed category of front/rear tires	W, minimum requirement: 168 mph (270 km/h)

Front wheel

Front wheel design	Aluminum cast wheel
Front-wheel rim size	3.5" x 17"
Front tire designation	120/70 - ZR 17
Load index for front tire	At least 58
Permissible front wheel load	max 397 lbs (max 180 kg)
Permissible front-wheel imbalance	max 0.2 oz (max 5 g)

Rear wheel

Rear wheel design	Aluminum cast wheel
Rear-wheel rim size	5.5" x 17"
Rear tire designation	180/55 - ZR 17
Load index for rear tire	At least 73
Permissible rear wheel load	max 716 lbs (max 325 kg)
Permissible rear-wheel imbalance	max 1.6 oz (max 45 g)

Tire inflation pressures

Tire pressure, front	36.3 psi (2.5 bar), with tire cold
Tire pressure, rear	42.1 psi (2.9 bar), with tire cold

Electrical system

Electrical rating of onboard sockets	max 5 A, all onboard sockets together
Fuse carrier 1	10 A, Slot 1: instrument cluster, anti-theft alarm system (DWA), ignition lock, main relay and diagnostic socket 7.5 A, Slot 2: left multifunction switch, Tire Pressure Control (TCP/RDC), yaw rate sensor
Fuse carrier	50 A, Fuse 1: Voltage regulator

Battery

Battery design	AGM battery (Absorbent Glass Mat)
– with HP battery ^{OE}	Lithium ion battery
Battery voltage	12 V
– with HP battery ^{OE}	12 V
Battery capacity	12 Ah
– with HP battery ^{OE}	10 Ah

Spark plugs

Spark plugs, manufacturer and designation	NGK LMAR8AI-10
---	----------------

Light sources

Bulb for high-beam headlight	LED
Bulbs for low-beam headlight	LED
Bulb for parking light	LED
Bulb for taillight/brake light	LED
Bulbs for flashing turn indicators, front	RY10W / 12 V / 10 W
Bulbs for flashing turn indicators, rear	RY10W / 12 V / 10 W

Anti-theft alarm system

Activation time	Approx. 30 s
Alarm duration	Approx. 26 s
Battery type	CR 123 A

Dimensions

Motorcycle length	85.2 in (2165 mm), measured across license-plate carrier
Motorcycle height	min 51.2 in (min 1300 mm), measured above mirror, at DIN unladen weight
Motorcycle width	34.6 in (880 mm), with mirrors 39.3 in (999 mm), with cases
Driver's seat height	32.3 in (820 mm), without rider at DIN unladen weight
– with Option 719 seat ^{OE}	32.3 in (820 mm), without rider at DIN unladen weight
– with rider's seat, low ^{OE}	29.9 in (760 mm), without rider at DIN unladen weight
– with seat Sport ^{OE}	33.1 in (840 mm), without rider at DIN unladen weight
Rider's inside-leg arc, heel to heel	72.4 in (1840 mm), without rider at unladen weight
– with Option 719 seat ^{OE}	72.4 in (1840 mm), without rider at unladen weight
– with rider's seat, low ^{OE}	67.7 in (1720 mm), without rider at unladen weight

– with seat Sport ^{OE}	73.8 in (1875 mm), without rider at unladen weight
---------------------------------	--

Weights

Vehicle curb weight	527 lbs (239 kg), DIN unladen weight, ready for road, 90 % full tank of gas, without OE
Permissible gross weight	1014 lbs (460 kg)
Maximum payload	487 lbs (221 kg)

Performance data

Top speed	>124 mph (>200 km/h)
– with touring case ^{OA}	112 mph (180 km/h)
– with topcase ^{OA}	112 mph (180 km/h)

Service

Reporting safety defects	230
BMW Motorrad Service	231
BMW Motorrad Service History	231
BMW Motorrad Mobility Services	232
Maintenance procedures	232
BMW Service	232
Maintenance schedule	235
Maintenance confirmations	236
Service confirmations	250

Reporting safety defects

If you think that your motorcycle has a fault which may cause an accident, injury or death, you must inform the NHTSA (National Highway Traffic Safety Administration) immediately and BMW of North America, LLC.

If the NHTSA receives other similar complaints, it may open an investigation. If it finds that a safety defect exists in a group of vehicles, the NHTSA may order the manufacturer to perform a recall and remedy campaign. However, the NHTSA cannot become involved in individual problems between you, your authorized BMW Motorrad retailer, or BMW of North America, LLC.

You can contact the NHTSA by calling the Vehicle Safety Hotline on 1-888-327-4236 (Teletypewriter TTY for the hearing impaired: 1-800-424-9153) for free, by visiting the website at <http://www.safercar.gov> or by writing to Administrator, NHTSA, 400 Seventh Street, SW., Washington, DC 20590. Further information on vehicle safety is available at <http://www.safercar.gov>.

BMW Motorrad Service

With its worldwide retailer network, BMW Motorrad can attend to you and your motorcycle in over 100 countries around the globe. Authorized BMW Motorrad retailers have the technical information and expertise needed to conduct reliable service and repairs covering every aspect of your BMW.

You will find the nearest authorized BMW Motorrad retailer to you at our website:

bmw-motorrad.com

WARNING

Improperly performed maintenance and repair work

Accident hazard caused by subsequent damage

- BMW Motorrad recommends having corresponding work on the motorcycle carried out

by a specialized workshop, preferably by an authorized BMW Motorrad retailer. ◀

To ensure that your BMW consistently remains in optimal condition BMW Motorrad urges you to observe the recommended service intervals. Have all maintenance and repair work confirmed in the "Service" chapter in this manual. Documentation confirming regular maintenance is essential for generous treatment of claims submitted after the warranty period has expired (goodwill).

You can obtain information on the contents of the BMW Services from your BMW Motorrad retailer.

BMW Motorrad Service History

Entries

Maintenance work that has been performed is recorded in the diagnostics and information system. Like a Service Booklet, these entries provide proof of regular maintenance.

If an entry is made in the vehicle's electronic Service Manual, service-related data is stored on the central IT systems of BMW AG in Munich, Germany.

When there is a change in vehicle owner, the data entered in the electronic Service History can also be viewed by the new vehicle owner. A BMW Motorrad retailer or specialist workshop can view the data entered in the electronic Service Manual.

Objection

At the BMW Motorrad retailer or specialist workshop, the vehicle owner can object to the entry of data in the electronic Service Manual with the related storage of data in the vehicle and the transfer of data to the vehicle manufacturer during his time as the vehicle owner. In this case, no entry is made in the vehicle's electronic Service Manual.

BMW Motorrad Mobility Services

The BMW Motorrad Mobility Services furnish you and your new BMW motorcycle with extra security by offering a wide array of assistance services in the event of a breakdown (BMW Roadside Assistance, breakdown assistance, vehicle recovery and retrieval, etc.).

Contact your authorized BMW Motorrad retailer for

additional information on available mobility-maintenance services.

Maintenance procedures

BMW pre-delivery check

The BMW pre-delivery check is carried out by your authorized BMW Motorrad retailer before it turns the motorcycle over to you.

BMW Running-in check



Carrying out the running-in check

311...746 miles
(500...1200 km)

BMW Service

BMW Service is carried out once a year. The scope of the services performed may be dependent on the motorcycle owner and the mileage driven. Your BMW Motorrad retailer confirms

that the service has been performed and enters the date for the next service.

For riders who drive long distances annually, it may be necessary to come in for service before the entered date. In this case a corresponding maximum odometer reading will also be entered in the confirmation of service. If this odometer reading is reached before the next service date, service must be performed sooner.

The service interval indicator in the display reminds you of the next service date approx. one month or 620 miles (1000 km) before the entered values.

More information on the topic of service is available at:

bmw-motorrad.com/service

The required scope of maintenance work for your vehicle can be found in the following maintenance schedule:

Maintenance schedule

- 1** BMW Running-in check
(including oil change)
- 2** BMW Service Standard
Scope
- 3** Engine oil change with filter
- 4** Oil change in the rear
bevel gears
- 5** Check valve clearance
- 6** Replace all spark plugs
- 7** Replace air cleaner insert
- 8** Telescopic fork oil change
- 9** Change brake fluid in entire system
 - a annually or every
6000 miles (10000 km)
(whichever comes first)
 - b annually or every
12000 miles
(20000 km) (whichever
comes first)
 - c for the first time after one
year, then every two years

Maintenance confirmations

BMW Service standard scope

The repair procedures belonging to the BMW Service standard package are listed below. The actual maintenance work applicable for your vehicle may differ.

- Performing the vehicle test using the BMW Motorrad diagnosis system
- Visual inspection of the clutch system
- Visual inspection of the brake lines, brake hoses, and connections
- Checking front brake pads and brake disks for wear
- Checking the front wheel brake fluid level
- Checking the rear brake pads and brake disk for wear
- Checking the rear wheel brake fluid level
- Checking coolant level
- Check side stand for ease of movement
- Checking the center stand for ease of movement
- Checking the tire pressure and tread depth
- Check the tension of the spokes and tighten as needed
- Checking the lighting and signal system
- Functional check for engine starting suppression
- Final inspection and road safety check
- Set the service date and remaining distance using the BMW Motorrad diagnostic system
- Checking charging state of battery
- Confirm the BMW service in the vehicle literature

BMW pre-delivery check

performed

on _____

Stamp, signature

BMW Running-in Check

performed

on _____

at km _____

Next service

latest

on _____

or, if reached earlier

at km _____

Stamp, signature

BMW Service

performed

on _____

at km _____

Next service

latest

on _____

or, if reached earlier

at km _____

Work performed

BMW Service

Engine oil change with filter

Oil change in rear bevel gears

Checking valve clearance

Replacing all spark plugs

Replacing air cleaner element

Checking or replacing air cleaner element (maintenance)

Changing brake fluid in entire system

Yes

No

Information

Stamp, signature

BMW Service

performed

on _____

at km _____

Next service

latest

on _____

or, if reached earlier

at km _____

Work performed

BMW Service

Engine oil change with filter

Oil change in rear bevel gears

Checking valve clearance

Replacing all spark plugs

Replacing air cleaner element

Checking or replacing air cleaner element (maintenance)

Changing brake fluid in entire system

Yes

No

Information

Stamp, signature

BMW Service

performed

on _____

at km _____

Next service

latest

on _____

or, if reached earlier

at km _____

Work performed

BMW Service

Engine oil change with filter

Oil change in rear bevel gears

Checking valve clearance

Replacing all spark plugs

Replacing air cleaner element

Checking or replacing air cleaner element (maintenance)

Changing brake fluid in entire system

Yes

No

Information

Stamp, signature

BMW Service

performed

on _____

at km _____

Next service

latest

on _____

or, if reached earlier

at km _____

Work performed

BMW Service

Engine oil change with filter

Oil change in rear bevel gears

Checking valve clearance

Replacing all spark plugs

Replacing air cleaner element

Checking or replacing air cleaner element (maintenance)

Changing brake fluid in entire system

Yes

No

Information

Stamp, signature

BMW Service

performed

on _____

at km _____

Next service

latest

on _____

or, if reached earlier

at km _____

Work performed

BMW Service

Engine oil change with filter

Oil change in rear bevel gears

Checking valve clearance

Replacing all spark plugs

Replacing air cleaner element

Checking or replacing air cleaner element (maintenance)

Changing brake fluid in entire system

Yes

No

Information

Stamp, signature

BMW Service

performed

on _____

at km _____

Next service

latest

on _____

or, if reached earlier

at km _____

Work performed

BMW Service

Engine oil change with filter

Oil change in rear bevel gears

Checking valve clearance

Replacing all spark plugs

Replacing air cleaner element

Checking or replacing air cleaner element (maintenance)

Changing brake fluid in entire system

Yes No

Information

Stamp, signature

BMW Service

performed

on _____

at km _____

Next service

latest

on _____

or, if reached earlier

at km _____

Work performed

BMW Service

Engine oil change with filter

Oil change in rear bevel gears

Checking valve clearance

Replacing all spark plugs

Replacing air cleaner element

Checking or replacing air cleaner element (maintenance)

Changing brake fluid in entire system

Yes

No

Information

Stamp, signature

BMW Service

performed

on _____

at km _____

Next service

latest

on _____

or, if reached earlier

at km _____

Work performed

BMW Service

Engine oil change with filter

Oil change in rear bevel gears

Checking valve clearance

Replacing all spark plugs

Replacing air cleaner element

Checking or replacing air cleaner element (maintenance)

Changing brake fluid in entire system

Yes No

Information

Stamp, signature

BMW Service

performed

on _____

at km _____

Next service

latest

on _____

or, if reached earlier

at km _____

Work performed

BMW Service

Engine oil change with filter

Oil change in rear bevel gears

Checking valve clearance

Replacing all spark plugs

Replacing air cleaner element

Checking or replacing air cleaner element (maintenance)

Changing brake fluid in entire system

Yes

No

Information

Stamp, signature

BMW Service

performed

on _____

at km _____

Next service

latest

on _____

or, if reached earlier

at km _____

Work performed

BMW Service

Engine oil change with filter

Oil change in rear bevel gears

Checking valve clearance

Replacing all spark plugs

Replacing air cleaner element

Checking or replacing air cleaner element (maintenance)

Changing brake fluid in entire system

Yes No

Information

Stamp, signature

BMW Service

performed

on _____

at km _____

Next service

latest

on _____

or, if reached earlier

at km _____

Work performed

BMW Service

Engine oil change with filter

Oil change in rear bevel gears

Checking valve clearance

Replacing all spark plugs

Replacing air cleaner element

Checking or replacing air cleaner element (maintenance)

Changing brake fluid in entire system

Yes

No

Information

Stamp, signature

BMW Service

performed

on _____

at km _____

Next service

latest

on _____

or, if reached earlier

at km _____

Work performed

BMW Service

Engine oil change with filter

Oil change in rear bevel gears

Checking valve clearance

Replacing all spark plugs

Replacing air cleaner element

Checking or replacing air cleaner element (maintenance)

Changing brake fluid in entire system

Yes No

Information

 Stamp, signature

Service confirmations

The table serves to provide evidence of maintenance and repair work, as well as installed optional accessories and special campaigns performed.

Work performed	at km	Date

Appendix

Certificate for Electronic Immobilizer	254
Certificate for Keyless Ride	256
Certificate for Tire Pressure Control	258
Certificate for TFT instrument cluster	259

FCC Approval

Ring aerial in the ignition switch



To verify the authorization of the ignition key, the electronic immobilizer exchanges information with the ignition key via the ring aerial.

This device complies with Part 15 of the FCC rules. Operation is subject to the following two conditions:

- (1) This device may not cause harmful interference, and
- (2) this device must accept any interference received, including interference that may cause undesired operation.



Any changes or modifications not expressly approved by the party responsible for compliance could void the user's authority to operate the equipment. ◀

Approbation de la FCC

Antenne annulaire présente dans le commutateur d'allumage



Pour vérifier l'autorisation de la clé de contact, le système d'immobilisation électronique échange des

informations avec la clé de contact via l'antenne annulaire.

Le présent dispositif est conforme à la partie 15 des règles de la FCC. Son utilisation est soumise aux deux conditions suivantes :

- (1) Le dispositif ne doit pas produire d'interférences nuisibles, et
- (2) le dispositif doit pouvoir accepter toutes les interférences extérieures, y compris celles qui pourraient provoquer une activation inopportune.



Toute modification qui n'aurait pas été approuvée expressément par l'organisme responsable de l'homologation peut annuler l'autorisation accordée à l'utilisateur pour utiliser le dispositif. ◀

Certifications

BMW Keyless Ride ID Device



USA, Canada

Product name: BMW Keyless Ride ID Device
FCC ID: YGOHUF5750
IC: 4008C-HUF5750

Canada:

Operation is subject to the following two conditions:

- (1) This device may not cause harmful interference, and
- (2) this device must accept any interference received, including interference that may cause undesired operation.

USA:

This device complies with Part 15 of the FCC rules. Operation is subject to the following two conditions:

- (1) This device may not cause harmful interference, and
- (2) this device must accept any interference received, including interference that may cause undesired operation.



Any changes or modifications not expressly approved by the party responsible for compliance could void the user's authority to operate the equipment.

Declaration Of Conformity

We declare under our responsibility that the product

BMW Keyless Ride ID Device (Model: HUF5750)

complies with the appropriate essential requirements of the article 3 of the R&TIE and the other relevant provisions, when used for its intended purpose. Applied Standards:

1. Health and safety requirements contained in article 3 (1) a)
 - EN 60950-1:2006+A11:2009+A1:2010+A12:2011; Information technology equipment- Safety
2. Protection requirements with respect to electromagnetic compatibility article 3 (1) b)
 - EN 301 489-1 (V1 .9.2, 09/2011), Electromagnetic compatibility and radio spectrum matters (ERM); Electromagnetic compatibility (EMC) standard for radio equipment and services; Part 1: Common technical requirements
 - EN 301 489-3 (V1.4.1, 08/2002) Electromagnetic compatibility and radio spectrum matters (ERM); Electromagnetic compatibility (EMC) standard for radio equipment and services; Part 3: Specific conditions for short range devices (SRD) operating on frequencies between 9 kHz and 40 GHz
3. Means of the efficient use of the radio frequency spectrum article 3 (2)
 - EN 300 220-1 & -2 (V2.4.1, 05/2012), electromagnetic compatibility and radio spectrum matters (ERM); Short range devices (SRD); Radio equipment to be used in the 25 MHz to 1000 MHz frequency range with power levels ranging up to 500 mW;
Part 1: Technical characteristics and test methods.
Part 2: Harmonized EN covering essential requirements under article 3.2 of the R&TIE directive

The product is labeled with the CE marking: **CE**

Velbert, October 15th, 2013

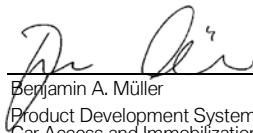

Benjamin A. Müller
Product Development Systems
Car Access and Immobilization – Electronics
Huf Hülsbeck & Fürst GmbH & Co. KG
Steeger Straße 17, D-42551 Velbert

Certification Tire Pressure Control (TPC)

FCC ID: MRXBC54MA4
IC: 2546A-BC54MA4

FCC ID: MRXBC5A4
IC: 2546A-BC5A4

This device complies with Part 15 of the FCC Rules and with Industry Canada license-exempt RSS standard(s).

Operation is subject to the following two conditions:

- (1) This device may not cause harmful interference, and
- (2) This device must accept any interference received, including interference that may cause undesired operation.

Le présent appareil est conforme aux CNR d'Industrie Canada applicables aux appareils radio exempts de licence. L'exploitation est autorisée aux deux conditions suivantes:

- (1) l'appareil ne doit pas produire de brouillage, et
- (2) l'utilisateur de l'appareil doit accepter tout brouillage radioélectrique subi, même si le brouillage est susceptible d'en compromettre le fonctionnement.

WARNING: Changes or modifications not expressly approved by the party responsible for compliance could void the user's authority to operate the equipment. The term "IC:" before the radio certification number only signifies that Industry Canada technical specifications were met.

Declaration of Conformity

Radio equipment TFT instrument cluster

For all Countries without EU

Technical information

BT operating frq. Range: 2402 – 2480 MHz

BT version: 4.2 (no BTLE)

BT output power: < 4 dBm

WLAN operating frq. Range: 2412 – 2462 MHz

WLAN standards: IEEE 802.11 b/g/n

WLAN output power: < 20 dBm

Manufacturer and Address

Manufacturer:

Robert Bosch Car Multimedia GmbH

Adress: Robert Bosch Str. 200,

31139 Hildesheim, GERMANY

Turkey

Robert Bosch Car Multimedia GmbH, ICC6.5in tipi telsiz sisteminin 2014/53/EU nolu yönetmeliğe uygun olduğunu beyan eder. AB Uygunluk Beyanı'nın tam metni, aşağıdaki internet adresinden görülebilir: <http://cert.bosch-carmultimedia.net>

Brazil

Este equipamento opera em caráter secundário, isto é, não tem direito a proteção contra interferência prejudicial, mesmo de estações do mesmo tipo, e não pode causar interferência a sistemas operando em caráter primário.

Canada

This device complies with Industry Canada's licence-exempt RSSs and part 15 of the FCC Rules. Operation is subject to the following two conditions:

(1) this device may not cause interference, and
(2) this device must accept any interference, including interference that may cause undesired operation of the device.

Changes or modifications not expressly approved by the party responsible for compliance could void the user's authority to operate the equipment.

Le présent appareil est conforme aux CNR d'Industrie Canada applicables aux appareils radio exempts de licence. L'exploitation est autorisée aux deux conditions suivantes : (1) l'appareil ne doit pas produire de brouillage, et (2) l'appareil doit accepter tout brouillage radioélectrique subi, même si le brouillage est susceptible d'en compromettre le fonctionnement.

Mexico

La operación de este equipo está sujeta a las siguientes dos condiciones:

(1) es posible que este equipo o dispositivo no cause interferencia perjudicial y
(2) este equipo o dispositivo debe aceptar cualquier interferencia, incluyendo la que pueda causar su operación no deseada.

Taiwan, Republic of

根據 NCC 低功率電波輻射性電機管理辦法 規定：
第十二條

經型式認證合格之低功率射頻電機，非經許可，公司、商號或使用者均不得擅自變更頻率、加大功率或變更原設計之特性及功能。

第十四條

低功率射頻電機之使用不得影響飛航安全及干擾合法通信；經發現有干擾現象時，應立即停用，並改善至無干擾時方得繼續使用。

前項合法通信，

指依電信法規定作業之無線電通信。

低功率射頻電機須忍受合法通信或工業、科學及醫療用電波輻射性電機設備之干擾。

Thailand

เครื่องโทรคมนาคมและอุปกรณ์นี้

มีความสอดคล้องตามข้อกำหนดของ กทช.

(This telecommunication equipments is in compliance with NTC requirements)

United States (USA)

This device complies with Industry Canada's licence-exempt RSSs and part 15 of the FCC Rules. Operation is subject to the following two conditions:

(1) this device may not cause interference, and
(2) this device must accept any interference, including interference that may cause undesired operation of the device.

Changes or modifications not expressly approved by the party responsible for compliance could void the user's authority to operate the equipment.

Le présent appareil est conforme aux CNR d'Industrie Canada applicables aux appareils radio exempts de licence. L'exploitation est autorisée aux deux conditions suivantes : (1) l'appareil ne doit pas produire de brouillage, et (2) l'appareil doit accepter tout brouillage radioélectrique subi, même si le brouillage est susceptible d'en compromettre le fonctionnement.

Korea

적합성평가에 관한 고시

R-CMM-RBR-ICC651N

상호 : Robert Bosch Car Multimedia

GmbH 모델명 : ICC6.5in

기자재명칭 : 특정소출력 무선기기

(무선데이터통신시스템용 무선기기)

제조사 및 제조국가 : Robert Bosch Car
Multimedia GmbH / 포르투갈

제조년월 : 제조년월로 표기

이 기기는 업무용 환경에서 사용할 목적으로 적합성평가를 받은 기기로서 가정용 환경에서 사용하는 경우 전파간섭의 우려가 있습니다.

A

Abbreviations and symbols, 6

ABS

Control, 19

Displays, 49

Operating, 67

Self-diagnosis, 128, 129

Technology in detail, 142

Accessories

General notes, 192

Air filter

Position in motorcycle, 17

Replacing the insert, 177

Ambient temperature

Outside temperature

warning, 38

Anti-theft alarm system

Indicator light, 22

Operating, 82

Warning indicator, 41

ASC

Control, 19

Indicator and warning light , 50

Operating, 69

Self-diagnosis, 130

Technology in detail, 145

B**Battery**

Charge connected battery, 183

Charging disconnected

battery, 184

Indicator light for vehicle

voltage, 39

Installing, 185

Maintenance instructions, 182

Removing, 184

Technical Data, 225

Bluetooth, 98

Pairing, 99

Brake fluid

Check fluid level at rear, 166

Check front fluid level, 165

Front reservoir, 17

Rear reservoir, 17

Brake pads

Breaking in, 131

Check front, 163

Check rear, 164

Brakes

ABS Pro in detail, 144

ABS Pro dependent on riding

mode, 134

Adjust footbrake lever, 117

Adjusting handlebar lever, 116

Checking operation, 162

Safety information, 133

Technical Data, 223

Breaking in, 131**Bulbs**

Replace additional LED

headlight, 181

Replace LED headlights, 181

Replacing LED tail light, 181

Technical data, 226

Turn indicators, 179

Warning indicator for defective

bulb, 40

- C**
Care
 Chrome, 207
 Paint preservation, 208
Case, 193
Check Control
 Dialog, 28
 Display, 28
Checklist, 126
Clock
 Adjusting, 97
Clutch
 Adjusting handlebar lever, 114
 Checking operation, 167
 Technical Data, 220
Coolant
 Check fill level, 167
 Indicator light for excess temperature, 43
 Topping up, 168
Cruise-control system
 Operating, 76
- D**
Damping
 Rear adjuster, 15
Deceleration, 105
Diagnostic connector
 fasten, 188
 Loosen, 188
Dimensions
 Technical Data, 227
DTC, 105
 Indicator and warning light , 50
 Operating, 69
 Technology in detail, 145
DWA
 Technical Data, 226
Dynamic Brake Control, 149
 Technology in detail, 149
- E**
Electrical system
 Technical Data, 225
Emergency on/off switch (kill switch), 21
 Operating, 64

- Engine
 Indicator light for engine control, 44
 Starting, 127
 Technical Data, 219
 Warning light for electronic engine management, 43
Engine oil
 Check fill level, 161
 Electronic oil-level check, 42
 Filling location, 17
 Fluid level indicator, 17
 Indicator light for engine oil level, 42
 Technical Data, 219
 Topping up, 162
Equipment, 7
ESA
 Control, 19
 Operating, 70
- F**
Frame
 Technical Data, 221
Front wheel stand
 Mounting, 159

- Fuel
 - Filling location, 15
 - Fuel specifications, 135
 - Refueling, 136, 137
 - refueling with Keyless Ride, 138
 - Technical Data, 218
- Fuel reserve
 - Range, 96
 - Warning indicator, 52
- Fuses
 - Replacing, 186
 - Technical Data, 225
- G**
- Gearshift assistant, 131
 - Gear not trained, 53
 - Riding, 131
 - Technology in detail, 152
- H**
- Hazard warning flashers
 - Control, 19, 21
 - Operating, 66
- Headlight
 - Headlight range, 113
- Headlight courtesy delay feature, 58, 65
- Heated handlebar grips
 - Control, 21
 - Operating, 84
- Hill Start Control, 79, 153
 - cannot be activated, 53
 - Indicator and warning lights, 53
 - Operating, 79
 - Technology in detail, 153
 - Turn on and off, 79
- Hill Start Control Pro
 - Adjusting, 80
 - Operating, 80
 - Technology in detail, 153
- Horn, 19
- I**
- Ignition
 - Switching off, 59
 - Switching on, 58
- Immobilizer
 - Emergency key, 62
 - Spare key, 59
- Indicator lights, 22
 - Overview, 24
- Instrument cluster
 - Ambient light photosensor, 22
 - Overview, 22
- J**
- Jump-start, 181
- K**
- Keyless Ride
 - EWS Electronic immobilizer, 62
 - If radio key is lost, 62
 - Locking the steering lock, 60
 - Switch off ignition, 61
 - Switching on ignition, 61
 - Unlocking fuel filler cap, 137, 138
 - Warning indicator, 38, 39
- Keys, 58, 60
- L**
- Lean angle, 105

Lights

- Control, 19
 - Headlight courtesy delay feature, 65
 - Low-beam headlight, 64
 - Operate additional high-beam headlight, 65
 - Operating headlight flasher, 64
 - Operating high-beam headlight, 64
 - Parking lights, 64, 65
- Lowered suspension
- Limitations, 124
- Luggage
- Loading information, 124

M

- Maintenance
- Maintenance schedule, 235
- Maintenance confirmations, 236
- Maintenance intervals, 232
- Media
- Operating, 109
- Menu
- Calling up, 92

Mirrors

- Adjusting, 112
 - Adjusting mirror arm, 113
 - Adjusting mirrors, 112
- Mobility Services, 232

Motorcycle

- Care, 205
- Cleaning, 205
- Lashing, 139
- Parking, 134
- Returning to use, 209
- Storage, 208

Muffler

- Installing the silencer, 177
- Removing the silencer, 176

Multifunction switch

- General view, left, 19
- General view, right, 21

N

- Navigation
- Operating, 107
- Notice concerning current status, 8

O

- Onboard computer, 102
- Onboard power socket
- Information on use, 192
 - Position on motorcycle, 17
- Onboard tool kit
- Position on motorcycle, 18
- Operating focus
- change, 93
- Outside temperature
- Display, 38
- Overview of warning indicators, 31
- Overviews, 105
- Indicator and warning lights, 24
 - Instrument cluster, 22
 - Left side of vehicle, 15
 - Left-side multifunction switch, 19
 - My vehicle, 102
 - Right side of vehicle, 17
 - Right-hand multifunction switch, 21
 - TFT display, 25, 27
 - Underneath the seat, 18

P

- Pairing, 99
- Parking light, 65
- Phone
 - Operating, 109
- Pre-Ride-Check, 128
- Pure Ride
 - Overview, 25

R

- RDC
 - Rim labels, 169
 - Technology in detail, 150
 - Warning lights, 45
- Rear-wheel drive
 - Technical Data, 221
- Rear-wheel stand
 - Mounting, 160
- Refueling, 136, 137
 - Fuel specifications, 135
 - with Keyless Ride, 138
- Remote control
 - Replacing the battery, 63
- Rider info status line
 - Adjusting, 94, 95

- Rider's Manual (US Model)
 - Position on motorcycle, 18
- Riding mode
 - Adjusting, 73
 - Control, 21
 - Setting the PRO riding mode, 75
 - Technology in detail, 148
- Road sign detection
 - switch on or off, 95
- S**
- Safety instructions
 - On braking, 133
 - On riding, 124
- Seat
 - Height adjustment position, 18
- Seats
 - Locking mechanism, 15
 - Removing and installing, 85
- Service, 231
 - Electronic Service Manual, 231
 - Reporting safety defects, 230
- Service display, 54

- Shift lever
 - Adjust the foot piece, 115
- ShiftCam, 155
 - Technology in detail, 155
- Shifting flash, 81
 - Adjusting, 81
 - Overview, 131
 - switching on/off, 81
- Shifting gears
 - Shiftpoint light, 132
 - Upshift recommendation, 97
- Spark plugs
 - Technical data, 225
- Speedometer, 22
- Spring preload
 - Adjusting, 119
 - Rear adjuster, 17
- Starting, 127
 - Control, 21
- Steering lock
 - Locking, 58
- Suspension
 - Technical Data, 222
- Switching off, 134

T

- Tachometer, 22
 - Tachometer, 96
- Technical data
 - Anti-theft alarm system, 226
 - Battery, 225
 - Brakes, 223
 - Clutch, 220
 - Dimensions, 227
 - Electrical system, 225
 - Engine, 219
 - Engine oil, 219
 - Frame, 221
 - Fuel, 218
 - General notes, 7
 - Light sources, 226
 - Rear-wheel drive, 221
 - Spark plugs, 225
 - Standards, 7
 - Suspension, 222
 - Transmission, 220
 - Weights, 228
 - Wheels and tires, 223
- TFT display, 22
 - Control, 19
 - Operating, 92, 93, 94
 - Overview, 25, 27
 - Selecting display readings, 89
- Tire Pressure Control TPC/RDC
 - Display, 44
- Tires
 - Breaking in, 131
 - Checking tire inflation pressures, 168
 - Checking tire tread depth, 168, 169
 - Inflation pressure table, 18
 - Inflation pressures, 224
 - Technical Data, 223
- Topcase
 - Operating, 195
- Torques, 215
- Traction Control
 - ASC, 145
 - DTC, 145
- Transmission
 - Technical Data, 220
- Troubleshooting chart, 212

- Turn indicators
 - Control, 19
 - Control, right, 21
 - Operating, 66
- Type plate
 - Position on motorcycle, 17

V

- Values
 - Display, 28
- Vehicle identification number
 - Position on motorcycle, 17
- Vehicle voltage
 - Warning indicator, 39

W

- Warning lamps, 22
 - ABS, 49
 - Anti-theft alarm system, 41
 - ASC, 50
 - Coolant temperature, 43
 - Display, 28
 - DTC, 50
 - Electronic engine management, 43

- Engine management system, 44
 - Engine oil level, 42
 - Fuel reserve, 52
 - Gear not trained, 53
 - Hill Start Control, 53
 - Light source defect, 40
 - My vehicle, 102
 - Outside temperature warning, 38
 - Overview, 24
 - TPM Tire Pressure Monitor, 45
 - Vehicle voltage, 39
- Weights
- Load capacity table, 18
 - Technical Data, 228
- Wheels
- Check wheel rims, 168
 - Checking wheel rims, 168
 - Installing front wheel, 172
 - Installing rear wheel, 175
 - Removing front wheel, 170
 - Size change, 169
 - Technical Data, 223

The descriptions and illustrations in this manual may vary from your own motorcycle's actual equipment, depending upon its equipment level and accessories as well as your specific national version. No claims stemming from these differences can be recognized.

Dimensions, weights, fuel consumption and performance data are quoted to the customary tolerances.

The right to modify designs, equipment and accessories is reserved.

Errors and omissions excepted.

© 2019 Bayerische Motoren Werke Aktiengesellschaft
80788 Munich, Germany
Reprints and duplication of this work, in whole or part, are prohibited without the express written approval of BMW Motorrad, Aftersales.

Original Rider's Manual, printed in Germany.

WARNING

Harmful substances

Operating, servicing and maintaining a passenger vehicle or off-road vehicle can expose you to chemicals including engine exhaust, carbon monoxide, phthalates and lead, which are known to the State of California to be carcinogenic or detrimental to childbirth or reproduction.

- To minimize exposure, avoid breathing exhaust, do not idle the engine except as necessary, service your vehicle in a well-ventilated area and wear gloves or wash your hands frequently when servicing your vehicle.
- For more information visit: www.P65Warnings.ca.gov/passenger-vehicle ◀

Important data for refueling:

Fuel	
Recommended fuel quality	Super unleaded (max 15% ethanol, E0/E5/E10/E15) 89 AKI (95 ROZ/RON) 90 AKI
Alternative fuel quality	Regular unleaded (restrictions with regard to power and fuel consumption). (max 15% ethanol, E0/E5/E10/E15) 87 AKI (91 ROZ/RON) 87 AKI
Usable fuel quantity	Approx. 4.8 gal (Approx. 18 l)
Reserve fuel quantity	Approx. 1.1 gal (Approx. 4 l)
Tire inflation pressures	
Tire pressure, front	36.3 psi (2.5 bar), with tire cold
Tire pressure, rear	42.1 psi (2.9 bar), with tire cold

You can find further information on all aspects of your vehicle at:
bmw-motorrad.com

BMW recommends **ADVANTEC**
ORIGINAL BMW ENGINE OIL

Order No.: 01 40 9 446 727
01.2019, 2nd edition, 07

