



BMW Motorrad

[bmw-motorrad.com](http://bmw-motorrad.com)



The Ultimate  
Riding Machine

Rider's Manual

**R 1200 R**

## Vehicle data/dealership details

### Vehicle data

---

Model

---

Vehicle Identification Number

---

Colour code

---

Date of first registration

---

Registration number

### Dealership details

---

Person to contact in Service department

---

Ms/Mr

---

Phone number

---

Dealership address/phone number (company stamp)

## Welcome to BMW

We congratulate you on your choice of a vehicle from BMW Motorrad and welcome you to the community of BMW riders. Familiarise yourself with your new vehicle so that you can ride it safely and confidently in all traffic situations.

### About this Rider's Manual

Please read this Rider's Manual carefully before starting to use your new BMW. It contains important information on how to operate the controls and how to make the best possible use of all your BMW's technical features. In addition, it contains information on maintenance and care to help you maintain your vehicle's reliability and safety, as well as its value.

This record of the maintenance work you have had performed on

your vehicle is a precondition for generous treatment of goodwill claims.

If the time comes to sell your BMW, please remember to hand over this Rider's Manual to the new owner. It is an important part of the vehicle.

### Suggestions and criticism

If you have questions concerning your vehicle, your authorised BMW Motorrad dealer will gladly provide advice and assistance.

We hope you will enjoy riding your BMW and that all your journeys will be pleasant and safe

BMW Motorrad.

01 40 8 357 901



# Table of Contents

<b>1 General instructions ....</b>	<b>5</b>	Multifunction display (Touring view) .....	24	Anti-lock brake system (ABS).....	69
Overview .....	6	Warnings .....	25	Automatic Stability Control (ASC) .....	71
Abbreviations and symbols .....	6	Service-due indicator .....	42	Electronic Suspension Adjustment (ESA) .....	72
Equipment .....	7	Fuel reserve .....	43	Riding mode .....	73
Technical data .....	7	Oil level .....	43	Cruise-control system .....	76
Actuality .....	7	Ambient temperature.....	44	Heated handlebar grips .....	78
<b>2 General views .....</b>	<b>9</b>	Tyre pressure .....	44	Front and rear seats.....	79
General view, left side .....	11	Recommendation to up-shift .....	45	<b>5 Adjustment.....</b>	<b>81</b>
General view, right side .....	13	Red rpm range .....	45	Mirrors .....	82
Underneath the seat .....	14	<b>4 Operation.....</b>	<b>47</b>	Headlight .....	82
Multifunction switch, left .....	15	Ignition .....	48	Clutch .....	83
Multifunction switch, right .....	17	Ignition with Keyless Ride .....	50	Brakes .....	84
Instrument panel .....	18	Emergency off switch (kill switch) .....	55	Spring preload .....	84
<b>3 Status indicators .....</b>	<b>19</b>	Lights .....	55	Damping .....	85
Indicator and warning lights .....	20	Daytime riding light.....	57	<b>6 Riding.....</b>	<b>87</b>
Multifunction display (Full view) .....	22	Hazard warning lights system .....	59	Safety instructions .....	88
Multifunction display (Sport view) .....	23	Turn indicators .....	60	Checklist .....	90
		Multifunction display .....	60	Starting.....	91
		Anti-theft alarm (DWA) .....	67	Running in .....	93
				Shifting gear .....	94

Brakes .....	95	Engine oil .....	122	Protective wax coating ....	176
Parking your motorcycle ....	97	Brake system .....	124	Laying up the motor-	
Refuelling .....	98	Clutch .....	128	cycle .....	176
Securing motorcycle for		Coolant.....	128	Restoring motorcycle to	
transportation .....	102	Tyres.....	129	use .....	176
<b>7 Engineering</b>		Rims and tyres .....	130	<b>11 Technical data .....</b>	<b>177</b>
<b>details .....</b>	<b>105</b>	Wheels .....	130	Troubleshooting chart.....	178
General instructions .....	106	Silencer .....	138	Threaded fasteners .....	179
Anti-lock brake system		Light source.....	139	Fuel .....	181
(ABS).....	106	Jump-starting .....	151	Engine oil .....	182
Automatic Stability Control		Battery .....	152	Engine .....	182
(ASC) .....	109	Fuses .....	156	Clutch .....	183
Dynamic Traction Control		Diagnostic connector.....	157	Transmission.....	184
(DTC) .....	110	<b>9 Accessories .....</b>	<b>159</b>	Final drive .....	184
Electronic Suspension Ad-		General instructions .....	160	Frame .....	185
justment (ESA) .....	112	Power sockets .....	160	Chassis and	
Riding mode .....	113	Cases .....	161	suspension .....	185
Tyre pressure monitoring		Topcase.....	164	Brakes .....	186
(RDC) .....	114	Navigation system.....	167	Wheels and tyres.....	186
Shift assistant Pro.....	116	<b>10 Care .....</b>	<b>173</b>	Electrical system .....	188
<b>8 Maintenance .....</b>	<b>119</b>	Care products .....	174	Anti-theft alarm.....	189
General instructions .....	120	Washing the vehicle.....	174	Dimensions .....	190
Toolkit.....	120	Cleaning easily damaged		Weights .....	191
Front-wheel stand.....	120	components.....	175	Riding specifications .....	191
Rear-wheel stand .....	122	Paint care .....	176		

<b>12 Service .....</b>	<b>193</b>
BMW Motorrad Service ...	194
BMW Motorrad Mobility services .....	194
Maintenance work.....	194
Maintenance schedule ....	197
Confirmation of mainten- ance work .....	198
Confirmation of service....	212
<b>13 Appendix.....</b>	<b>215</b>
Certificate for electronic immobiliser .....	216
Certificate for Key- less Ride .....	218
Certificate for tyre pressure control (RDC) .....	220
<b>14 Index .....</b>	<b>221</b>

## **General instructions**

Overview .....	6
Abbreviations and symbols .....	6
Equipment .....	7
Technical data .....	7
Actuality .....	7

## Overview

An important aspect of this Rider's Manual is that it can be used for quick and easy reference. Consulting the extensive index at the end of this Rider's Manual is the fastest way to find information on a particular topic or item. To first read an overview of your motorcycle, please go to chapter 2. All maintenance and repair work on the motorcycle is documented in Chapter 12. This record of the maintenance work you have had performed on your vehicle is a precondition for generous treatment of goodwill claims. When the time comes to sell your BMW, please remember to hand over this Rider's Manual; it is an important part of the motorcycle.

## Abbreviations and symbols

 **CAUTION** Low-risk hazard. Non-avoidance can lead to slight or moderate injury.



 **WARNING** Medium-risk hazard. Non-avoidance can lead to fatal or severe injury.

 **DANGER** High-risk hazard. Non-avoidance leads to fatal or severe injury.

 **ATTENTION** Special notes and precautionary measures. Non-compliance can lead to damage to the vehicle or accessory and, consequently, to voiding of the warranty.

 **NOTICE** Specific instructions on how to operate, control, adjust or look after items of equipment on the vehicle.

 Indicates the end of an item of information.

- Instruction.
- » Result of an activity.
-  Reference to a page with more detailed information.
- ◁ Indicates the end of a passage relating to specific accessories or items of equipment.
-  Tightening torque.
-  Technical data.
- OE Optional extras. The vehicles are assembled complete with all the BMW Motorrad optional extras originally ordered.



- OA Optional accessories. You can obtain BMW Motorrad optional accessories through your authorised BMW Motorrad dealer; optional accessories have to be retrofitted to the vehicle.
- EWS Electronic immobiliser.
- DWA Anti-theft alarm (Diebstahlwarnanlage).
- ABS Anti-lock brake system.
- ASC Automatic Stability Control.
- DTC Dynamic Traction Control (optional extra only in combination with Pro riding modes).

- ESA Electronic Suspension Adjustment.
- RDC Tyre pressure monitoring.

## Equipment

When you purchased your BMW motorcycle, you chose a model with individual equipment. This Rider's Manual describes the optional extras (OE) offered by BMW and selected optional accessories (OA). This explains why the manual may also contain descriptions of equipment which you have not ordered. Please note, too, that your motorcycle might not be exactly as illustrated in this manual on account of country-specific differences. If your motorcycle contains equipment that has not been described, its description can be found in a separate manual.

## Technical data

All dimensions, weights and power ratings stated in the Rider's Manual are quoted to the standards and comply with the tolerance requirements of the Deutsches Institut für Normung e.V. (DIN). Versions for individual countries may differ.

## Actuality

The high safety and quality level of BMW motorcycles is ensured by continuous development work on design, equipment and accessories. Because of this, your motorcycle may differ from the information supplied in the Rider's Manual. Nor can BMW Motorrad entirely rule out errors and omissions. We hope you will appreciate that no claims can be entertained on the basis of the data, illustrations or descriptions in this manual.





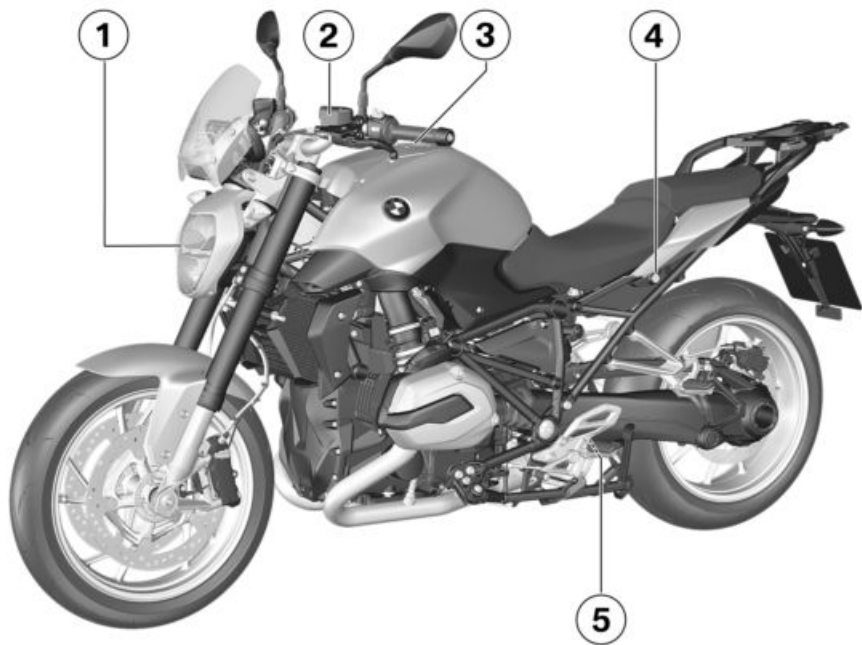

## General views

General view, left side.....	11
General view, right side .....	13
Underneath the seat .....	14
Multifunction switch, left .....	15
Multifunction switch, right.....	17
Instrument panel .....	18



## General view, left side

- 1** – with daytime running light<sup>OE</sup>  
– with Pro Headlight<sup>OE</sup>  
Manual daytime riding light  
( 57).
- 2** Clutch-fluid reservoir  
( 128)
- 3** Fuel filler neck ( 98)
- 4** Seat lock ( 79)
- 5** Setting the rear damping  
(down at the spring strut)  
( 85)

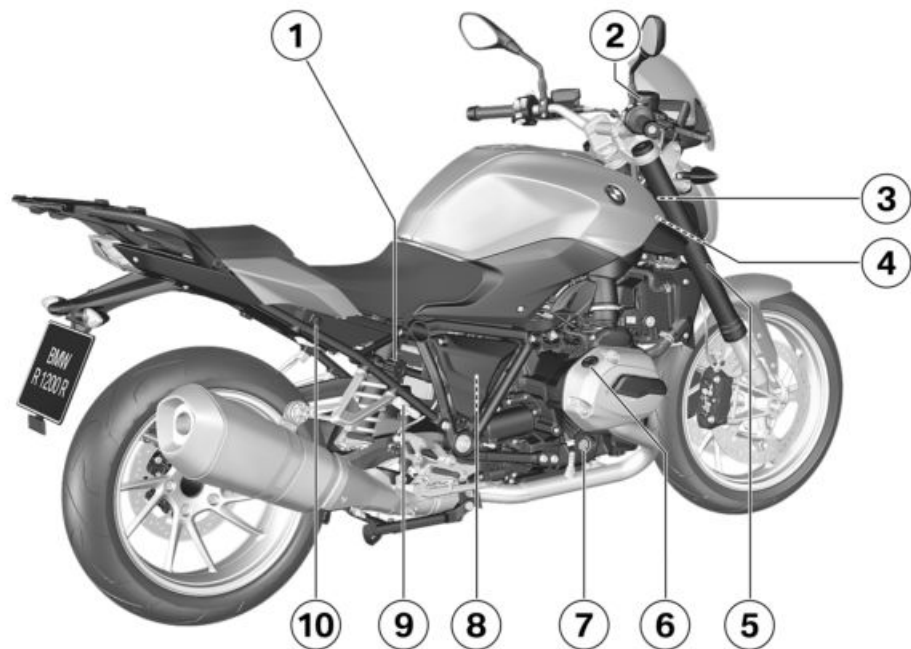

## General view, right side

10 Power socket (➡ 160)

- 1 Adjuster for spring preload, rear (➡ 84)
- 2 Brake-fluid tank, front (➡ 126)
- 3 Vehicle identification number (VIN) (on steering head, right)  
Type plate (on steering head, left)
- 4 Coolant-level indicator (➡ 128)  
Coolant reservoir (➡ 129)
- 5 Tyre pressure table
- 6 Oil filler neck (➡ 123)
- 7 Engine oil level indicator (➡ 122)
- 8 Behind the side trim panel:  
Battery (➡ 152)  
Positive battery connection point (➡ 151)  
Diagnostic connector (➡ 157)
- 9 Brake-fluid reservoir, rear (➡ 127)

## Underneath the seat

- 1 Fuses (→ 156)
- 2 Rider's Manual
- 3 Standard toolkit (→ 120)
- 4 Payload table

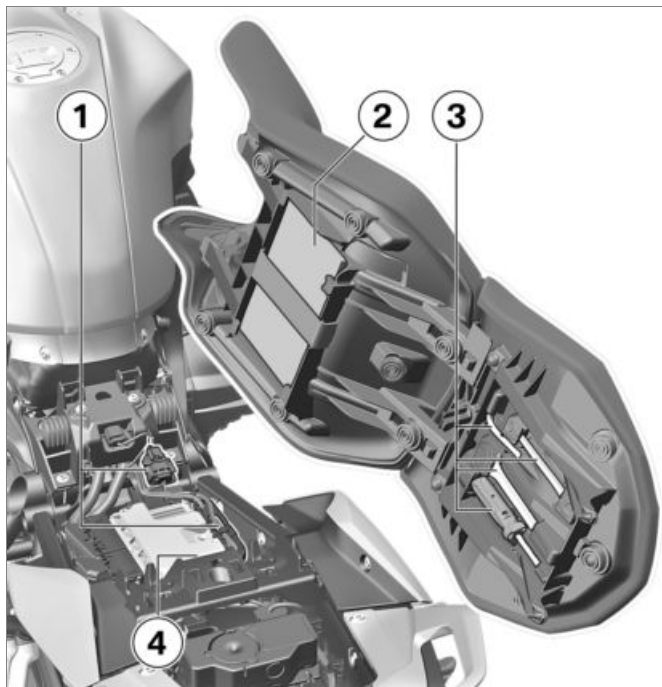







## Multifunction switch, left

- 1 High-beam headlight and headlight flasher (► 56)
- 2 – with cruise control<sup>OE</sup>  
Cruise-control system (► 76).
- 3 Hazard warning lights system (► 59)
- 4 ABS (► 69)  
ASC (► 71)  
– with Dynamic Traction Control (DTC)<sup>OE</sup>  
DTC (► 71)
- 5 – with Dynamic ESA<sup>OE</sup>  
Dynamic ESA Possible settings (► 72)
- 6 – with LED auxiliary headlights<sup>OA</sup>  
LED auxiliary headlights (► 56).
- 7 Turn indicators (► 60)
- 8 Horn

- 9** Multifunction display  
( 61)
- 10** – with preparation for navigation system<sup>OE</sup>  
Operating navigation system ( 168)  
Multi-Controller
- 11** – with daytime running light<sup>OE</sup>  
– with Pro Headlight<sup>OE</sup>  
Manual daytime riding light ( 57).



## Multifunction switch, right

- 1 – with heated handlebar grips<sup>OE</sup>  
Operating the heated handlebar grips (➔ 78).
- 2 Riding mode (➔ 73)
- 3 Emergency off switch (kill switch) (➔ 55)
- 4 Starter button  
Start engine (➔ 91).

## Instrument panel

- 1 Speedometer
- 2 Photosensor (for adapting the brightness of the instrument lighting)
  - with daytime running light<sup>OE</sup>
  - Photosensor for automatic daytime riding light
  - with alarm system (DWA)<sup>OE</sup>
  - Alarm system LED
  - with Keyless Ride<sup>OE</sup>
  - Telltale light for the radio-operated key
- 3 Indicator and warning lights (►► 20)
- 4 Multifunction display
  - There is a choice of 3 different display views:
  - Full view (►► 22)
  - Sport view (►► 23)
  - Touring view (►► 24)

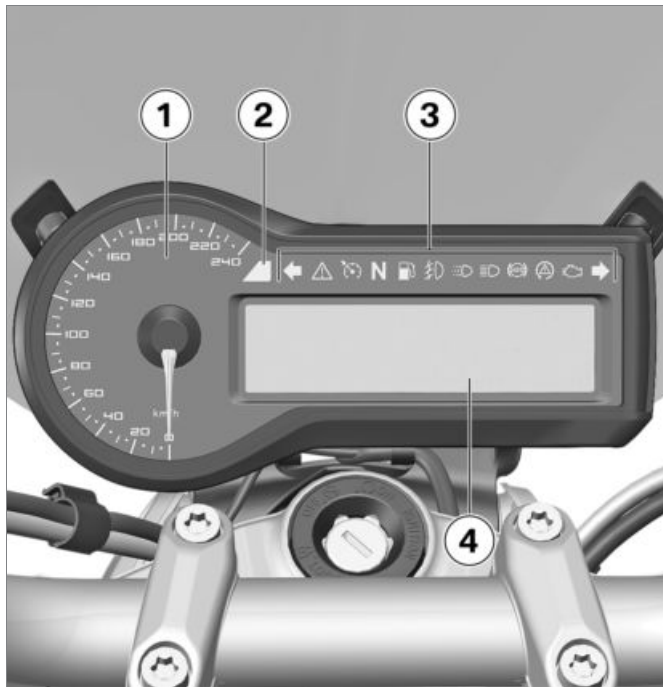

## Status indicators

Indicator and warning lights .....	20
Multifunction display (Full view) .....	22
Multifunction display (Sport view) .....	23
Multifunction display (Touring view) .....	24
Warnings .....	25
Service-due indicator .....	42
Fuel reserve .....	43
Oil level .....	43
Ambient temperature .....	44
Tyre pressure .....	44
Recommendation to upshift .....	45
Red rpm range .....	45

## Indicator and warning lights

- 1 General warning light (in combination with warning symbols on the display) (►► 25)
- 2 Neutral
- 3 – with LED auxiliary head-lights<sup>OA</sup>  
LED auxiliary headlights (►► 56).
- 4 High-beam headlight (►► 56)
- 5 ASC (►► 71)  
– with Dynamic Traction Control (DTC)<sup>OE</sup>  
DTC (►► 71)
- 6 Turn indicators, right
- 7 - with EU market export<sup>NV</sup>  
Malfunction indicator lamp  
Emissions warning (►► 34)
- 8 ABS (►► 69)

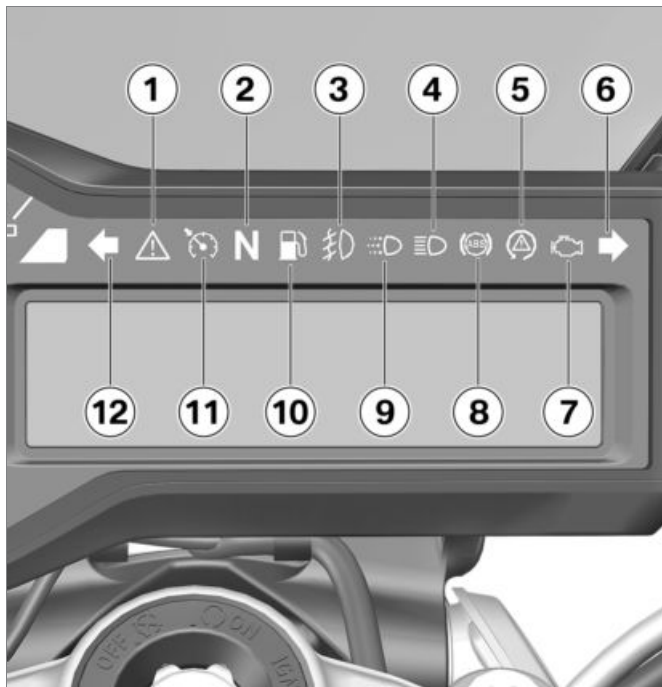

- 9** – with daytime running light<sup>OE</sup>  
– with Pro Headlight<sup>OE</sup>  
Manual daytime riding light (➡ 57).
- 10** Fuel reserve (➡ 43)
- 11** – with cruise control<sup>OE</sup>  
Cruise-control system (➡ 76).
- 12** Turn indicators, left

## Multifunction display (Full view)

- 1 Clock (➡ 64)
- 2 Engine speed display
- 3 Tripmeter reading  
On-board computer readings (➡ 61)
- 4 ESA setting (➡ 72)
- 5 Red rpm range (➡ 45)
- 6 Fuel level
- 7 Outside temperature warning (➡ 44)
- 8 Riding mode (➡ 73)
- 9 Tyre pressure monitoring  
(Reifendruck-Control, RDC)  
On-board computer readings (➡ 61)
- 10 Automatic daytime riding  
light (➡ 57)
- 11 Heating stages, handlebar  
grips (➡ 78)
- 12 Gear indicator; "N" indic-  
ates neutral

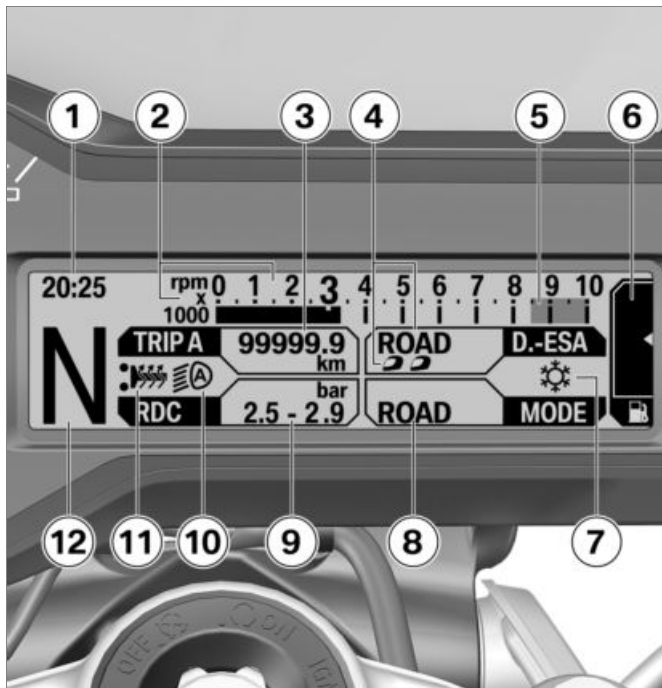



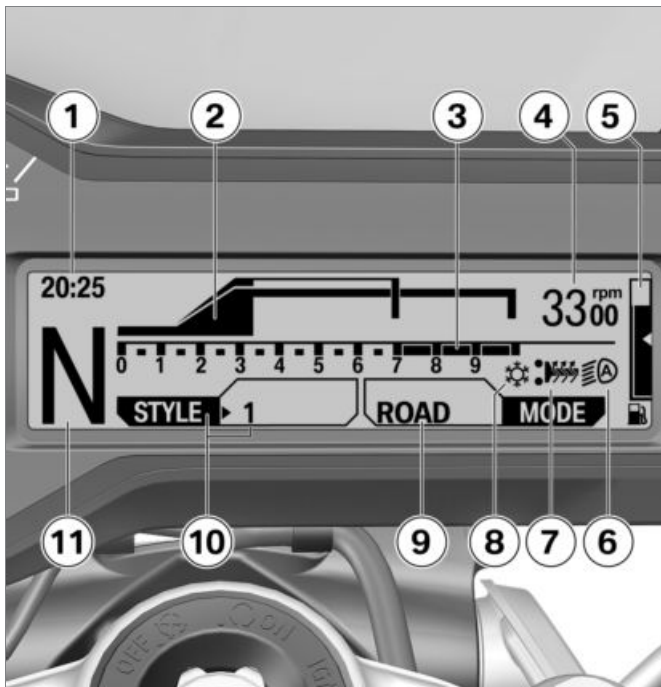

## Multifunction display (Sport view)

- 1 Clock (➡ 64)
- 2 Engine rpm bar
- 3 Red rpm range (➡ 45)
- 4 Engine rpm
- 5 Fuel level
- 6 Automatic daytime riding light (➡ 57)
- 7 Heating stages, handlebar grips (➡ 78)
- 8 Outside temperature warning (➡ 44)
- 9 Riding mode (➡ 73)
- 10 On-board computer readings (➡ 61)
- 11 Gear indicator; "N" indicates neutral

## Multifunction display (Touring view)

- 1 Clock (➡ 64)
- 2 Speedometer
- 3 Fuel level
- 4 Outside temperature warning (➡ 44)
- 5 Riding mode (➡ 73)
- 6 On-board computer readings (➡ 61)
- 7 Automatic daytime riding light (➡ 57)
- 8 Heating stages, handlebar grips (➡ 78)
- 9 Gear indicator; "N" indicates neutral

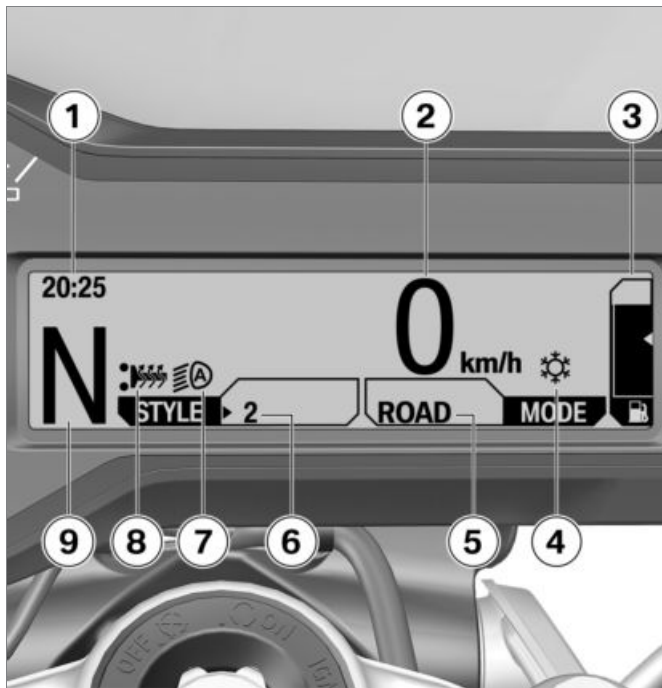

## Warnings

### Mode of presentation

Warnings are indicated by the corresponding warning lights.

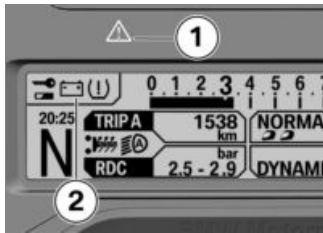

Warnings for which there is no dedicated warning light are indicated by 'General' warning light **1** showing along with up to three warning symbols at position **2** appearing in succession from right to left. These warning symbols appear in their order of priority. The highest priority is on the right. The 'general' warning light shows red or yellow, de-















pending on the urgency of the warning.













If multiple warnings are active at the same time the three highest-priority warnings are shown. The possible warnings are listed on the next pages.

## Warnings, overview

### Telltale and warning lights













### Warning symbols in the display

			Meaning
		 appears on the display	Outside temperature warning (►►► 31)
 lights up yellow	 appears on the display		EWS active (►►► 31)
 lights up yellow	 appears on the display		Radio-operated key out of range (►►► 31)
 lights up yellow	 appears on the display		Replace the battery of the radio-operated key (►►► 32)
 flashes red	 appears on the display		Coolant temperature too high (►►► 32)
	 appears on the display		Engine has not yet warmed up to operating temperature (►►► 32)
 lights up yellow	 appears on the display		Engine in emergency-operation mode (►►► 33)
 flashes yellow	 appears on the display		Severe fault in the engine control unit (►►► 33)

Telltale and warning lights	Warning symbols in the display	Meaning
 Malfunction indicator lamp lights up		Emissions warning (▶▶▶▶ 34)
	 appears on the display	Engine-oil level too low (▶▶▶▶ 34)
 flashes red	 appears on the display	Tyre pressure outside permitted tolerance (▶▶▶▶ 34)
 lights up yellow	 appears on the display	Sensor defective or system error (▶▶▶▶ 35)
	" _ _ " or " _ _ _ _ " is displayed.	
	" _ _ " or " _ _ _ _ " is displayed.	Signal transmission disrupted (▶▶▶▶ 35)
 lights up yellow	 appears on the display	Battery of tyre-pressure sensor weak (▶▶▶▶ 36)
 lights up yellow	 appears on the display	Light failure (▶▶▶▶ 36)
 lights up yellow	 appears on the display	Front light failure (▶▶▶▶ 37)

## Telltale and warning lights









## Warning symbols in the display

Telltale and warning lights		Warning symbols in the display		Meaning
	lights up yellow		appears on the display	Rear light failure (➡ 37)
			appears on the display	On-board system voltage low (➡ 38)
	lights up yellow		appears on the display	On-board system voltage critical (➡ 38)
	lights up red		appears on the display	Battery charge voltage insufficient (➡ 38)
			appears on the display	DWA battery weak (➡ 39)
	lights up yellow		appears on the display	DWA battery flat (➡ 39)
	shows yellow briefly		appears on the display	Service overdue (➡ 39)
	flashes			ABS self-diagnosis not completed (➡ 40)

## Telltale and warning lights

## Warning symbols in the display

## Meaning

	lights up		ABS fault (→ 40)
	lights up		ABS switched off (→ 40)
	quick-flashes		ASC/DTC intervention (→ 40)
	slow-flashes		ASC/DTC self-diagnosis not completed (→ 40)
	lights up		ASC/DTC switched off (→ 41)
	lights up		ASC/DTC fault (→ 41)
	lights up yellow		appears on the display ESA fault (→ 41)
			The gear indicator flashes. Gear not calibrated (→ 41)

## Telltale and warning lights

## Warning symbols in the display

## Meaning



lights up

Fuel down to reserve (  42)



## Outside temperature warning



appears on the display.

Possible cause:



The air temperature measured at the vehicle is lower than:

approx. 3 °C



### WARNING

## Risk of black ice also applicable at over 3 °C

Risk of accident

- Always take extra care when temperatures are low; remember that there is particular danger of black ice forming on bridges and where the road is in shade.◀
- Ride carefully and think well ahead.

## EWS active



lights up yellow.



appears on the display.

Possible cause:

The key being used is not authorised for starting, or communication between key and engine electronics is disrupted.

- Remove all other vehicle keys from the same ring as the ignition key.
- Use the emergency key.
- Have the defective key replaced, preferably by an authorised BMW Motorrad dealer.

## Radio-operated key out of range

– with Keyless Ride<sup>OE</sup>



lights up yellow.



appears on the display.

Possible cause:

Communication between R/C key and engine electronics is disrupted.

- Check the battery in the radio-operated key.
- Replace the battery of the radio-operated key (►► 54).
- Use the reserve key to continue your journey.
- Loss of the radio-operated key (►► 53).
- Remain calm if the warning symbol appears while you are riding. You can continue your journey, the engine will not switch off.
- Have the defective radio-operated key replaced by an authorised BMW Motorrad dealer.

## Replace the battery of the radio-operated key

– with Keyless Ride<sup>OE</sup>



lights up yellow.



appears on the display.

Possible cause:

- The integral battery in the radio-operated key has lost a significant proportion of its original capacity. There is no assurance of how long the R/C key can remain operational.
- Replace the battery of the radio-operated key (➡ 54).

## Coolant temperature too high



flashes red.



appears on the display.



### ATTENTION

#### Riding with overheated engine

Engine damage

- Compliance with the information set out below is essential. ◀

Possible cause:

The coolant level is too low.

- Check coolant level (➡ 128).
- If the coolant level is too low:
- Top up the coolant and have the coolant system checked by a specialist workshop, preferably by an authorised BMW Motorrad dealer.

Possible cause:

The coolant temperature is too high.

- If possible, ride in the part-load range to cool down the engine.
- If the coolant temperature is frequently too high, have the fault rectified as soon as possible by a specialist workshop, preferably an authorised BMW Motorrad dealer.

## Engine has not yet warmed up to operating temperature



shows only in Touring view.

Possible cause:

The engine has not yet warmed up to its operating temperature.

At low engine temperature:

- Do not warm up the engine with the vehicle at a standstill; instead, ride off at moderate engine rpm and speed.
- Riding at moderate engine rpm and speed is the quickest way

to warm up the engine from cold to operating temperature.



When operating temperature is reached the engine symbol shows for approximately 10 seconds, accompanied by OK.

» The engine symbol disappears from the display.

## Engine in emergency-operation mode



lights up yellow.



appears on the display.



### WARNING

## Unusual ride characteristics when engine running in emergency-operation mode

Risk of accident

- Adapt your style of riding accordingly: avoid accelerating sharply and overtaking.◀

Possible cause:

The engine control unit has diagnosed a fault. In exceptional cases, the engine stops and refuses to start. Otherwise, the engine runs in emergency operating mode.

- You can continue to ride, but bear in mind that the usual engine performance might not be available.
- Have the fault rectified as quickly as possible by a specialist workshop, preferably an authorised BMW Motorrad dealer.

## Severe fault in the engine control unit



flashes yellow.



appears on the display.



### WARNING

## Engine damage when running in emergency-operation mode

Risk of accident

- Adapt your style of riding accordingly: ride slowly, avoid sharp accelerating and overtaking.
- If possible, have the vehicle brought in and the fault rectified by a specialist workshop, preferably an authorised BMW Motorrad dealer.◀

Possible cause:

The engine control unit has diagnosed a fault which may cause severe secondary faults. The engine is in emergency-operation mode.

- It is possible to continue to ride but not recommended.
- Avoid high load and rpm ranges if possible.
- Have the fault rectified as quickly as possible by a specialist workshop, preferably an authorised BMW Motorrad dealer.

### Emissions warning



The malfunction indicator lamp lights up.

Possible cause:

The engine control unit has diagnosed a fault which affects the pollutant emissions.

- Have the fault rectified by a specialist workshop, preferably an authorised BMW Motorrad dealer.
- » You can continue riding; pollutant emissions are higher than the threshold values.

### Engine-oil level too low



appears on the display.

Possible cause:

The electronic oil-level sensor has registered an excessively low oil level. The next time you stop for fuel:

- Checking engine oil level (▢▢▢▢ 122).

If the oil level is too low:

- Topping up the engine oil (▢▢▢▢ 123).

If the oil level is correct:

- Seek the advice of a specialist workshop, preferably an authorised BMW Motorrad dealer.

### Tyre pressure outside permitted tolerance

- with tyre pressure monitoring (RDC)<sup>OE</sup>



flashes red.



appears on the display.



### WARNING

#### Tyre pressure outside permitted tolerance.

Impairment of the vehicle's handling characteristics.

- Adapt your style of riding accordingly.◀

Possible cause:

Measured tyre pressure is outside permitted tolerance.

- Check the tyre for damage and to ascertain whether the vehicle can be ridden with the tyre in its present condition.

If the vehicle can be ridden with the tyre in its present condition:

- Correct the tyre pressure at the earliest possible opportunity.



## NOTICE

Before you adjust tyre pressure, read the information on temperature compensation and adjusting pressure in the section entitled "Engineering details". ◀

- Have the tyre checked for damage by a specialist workshop, preferably an authorised BMW Motorrad dealer.

If you are unsure whether the vehicle can be ridden with the tyre in its present condition:

- Do not continue your journey.
- Notify the breakdown service.

### Sensor defective or system error

– with tyre pressure monitoring (RDC)<sup>OE</sup>



lights up yellow.



appears on the display.

"--" or "-- --" is displayed.

Possible cause:

Motorcycle is fitted with wheels not equipped with RDC sensors.

- Fit wheels and tyres equipped with RDC sensors.

Possible cause:

1 or 2 RDC sensors have failed or a system error has occurred.

- Have the fault rectified by a specialist workshop, preferably an authorised BMW Motorrad dealer.

### Signal transmission disrupted

– with tyre pressure monitoring (RDC)<sup>OE</sup>

"--" or "-- --" is displayed.

Possible cause:

The vehicle did not reach the minimum required speed (▶▶▶ 114).



RDC sensor is not active

min 30 km/h (The RDC sensor does not transmit its signal to the vehicle until a certain minimum speed has been reached.)

- Increase speed above this threshold and observe the RDC readings. Assume that a permanent fault has not occurred unless the 'General' warning light comes on to accompany the symptoms. Under these circumstances:
- Have the fault rectified by a specialist workshop, preferably an authorised BMW Motorrad dealer.

Possible cause:

Wireless communication with the RDC sensors has been disrupted. Possible causes include radio-communication systems operating in the vicinity and interfering with the link between the RDC control unit and the sensors.

- Move to another location and observe the RDC readings. Assume that a permanent fault has not occurred unless the 'General' warning light comes on to accompany the symptoms. Under these circumstances:
- Have the fault rectified by a specialist workshop, preferably an authorised BMW Motorrad dealer.

### Battery of tyre-pressure sensor weak

– with tyre pressure monitoring (RDC)<sup>OE</sup>



lights up yellow.



appears on the display.



#### NOTICE

This error message shows briefly only after the Pre-Ride-Check completes. ◀

Possible cause:

The integral battery in the tyre-pressure sensor has lost a significant proportion of its original capacity. There is no assurance of how long the tyre pressure control system can remain operational.

- Seek the advice of a specialist workshop, preferably an authorised BMW Motorrad dealer.

### Light failure



lights up yellow.



appears on the display.



#### WARNING

### Vehicle overlooked in traffic due to failure of the lights on the vehicle

Safety risk

- Replace defective bulbs as soon as possible; always carry a complete set of spare bulbs if possible. ◀

Possible cause:

A combination of light failures has occurred.

- Replacing bulbs for low-beam and high-beam headlight (➡ 139).
- Replacing bulb for parking light (➡ 143).
- Replacing bulbs for front and rear turn indicators (➡ 147).
- Replacing LED turn indicators (➡ 150).
- Replacing LED rear light (➡ 150).

### Front light failure



lights up yellow.



appears on the display.



### WARNING

### Vehicle overlooked in traffic due to failure of the lights on the vehicle

Safety risk

- Replace defective bulbs as soon as possible; always carry

a complete set of spare bulbs if possible.◀

Possible cause:

Low-beam headlight, high-beam headlight, side light, auxiliary headlight, daytime riding light or front turn indicator bulb faulty.

Faulty bulbs have to be replaced.

- Replacing bulbs for low-beam and high-beam headlight (➡ 139).
- Replacing bulb for parking light (➡ 143).
- Replacing bulbs for front and rear turn indicators (➡ 147).
- Replacing LED turn indicators (➡ 150).
- Replacing LED daytime riding light (➡ 150).
- Replacing LED additional headlights (➡ 150).

### Rear light failure



lights up yellow.



appears on the display.



### WARNING

### Vehicle overlooked in traffic due to failure of the lights on the vehicle

Safety risk

- Replace defective bulbs as soon as possible; always carry a complete set of spare bulbs if possible.◀

Possible cause:

Rear light or rear turn indicator is faulty.

The rear light or rear turn indicator bulb has to be replaced.

- Replacing LED rear light (➡ 150).

- Replacing bulbs for front and rear turn indicators (►►► 147).
- Replacing LED turn indicators (►►► 150).

## On-board system voltage low

 appears on the display. Generator power is only just sufficient to supply all consumers and charge the battery.

Possible cause:

Too many consumers switched on. On-board system voltage tends to drop particularly at low engine rpm and when the engine is idling.

- When riding at low engine rpm switch off all consumers that are not necessary for road safety (e.g. heated handlebar grips or auxiliary headlights).

## On-board system voltage critical

 lights up yellow.

 appears on the display.

Generator power is no longer sufficient to supply all consumers and charge the battery. In order to ensure that the engine can be started and the motorcycle ridden, the on-board electronics switch off the electricity supply to the on-board sockets and the auxiliary headlights. In extreme cases the seat heating and the grip heating might also be shut down.

Possible cause:

Too many consumers switched on. On-board system voltage tends to drop particularly at low engine rpm and when the engine is idling.

- When riding at low engine rpm switch off all consumers that are not necessary for road safety (e.g. heated handlebar grips or auxiliary headlights).

## Battery charge voltage insufficient

 lights up red.

 appears on the display.

## WARNING

**Discharged battery causes various motorcycle systems to fail, such as lighting, engine or ABS**

Risk of accident

- Do not continue your journey. ◀

Battery is not being charged. If you continue to ride the vehicle the on-board electronics will drain the battery.



Possible cause:

Alternator or alternator drive is faulty or the fuse for the alternator regulator has blown.

- Have the fault rectified as quickly as possible by a specialist workshop, preferably an authorised BMW Motorrad dealer.

### DWA battery weak

– with alarm system (DWA)<sup>OE</sup>



appears on the display.



#### NOTICE

This error message shows briefly only after the Pre-Ride-Check completes. ◀

Possible cause:

The integral battery in the anti-theft alarm (DWA) has lost a significant proportion of its original capacity. There is no assurance

of how long the DWA anti-theft alarm can remain operational if the vehicle's battery is disconnected.

- Seek the advice of a specialist workshop, preferably an authorised BMW Motorrad dealer.

### DWA battery flat

– with alarm system (DWA)<sup>OE</sup>



lights up yellow.



appears on the display.



#### NOTICE

This error message shows briefly only after the Pre-Ride-Check completes. ◀

Possible cause:

The integral battery in the anti-theft alarm (DWA) has lost its entire original capacity. There is no assurance that the DWA anti-

theft alarm will be operational if the vehicle's battery is disconnected.

- Seek the advice of a specialist workshop, preferably an authorised BMW Motorrad dealer.

### Service overdue



appears on the display.



shows yellow briefly after the Pre-Ride-Check.

Possible cause:

A necessary service has not been carried out.

- Have servicing carried out as quickly as possible by a specialist workshop, preferably an authorised BMW Motorrad dealer.

## ABS self-diagnosis not completed



flashes.

Possible cause:



ABS self-diagnosis not completed

The ABS function is not available, because self-diagnosis did not complete. (The motorcycle has to reach a defined minimum speed for the wheel speed sensors to be checked: 5 km/h)

- Pull away slowly. Bear in mind that the ABS function is not available until self-diagnosis has completed.

## ABS fault



lights up.

Possible cause:

The ABS control unit has detected a fault. The ABS function is not available.

- You can continue to ride. Bear in mind the more detailed information on certain situations that can lead to an ABS fault message (107).
- Have the fault rectified as quickly as possible by a specialist workshop, preferably an authorised BMW Motorrad dealer.

## ABS switched off



lights up.

Possible cause:

The rider has switched off the ABS system.

- Switch on the ABS function.

## ASC/DTC intervention



quick-flashes.

The ASC/DTC has detected a degree of instability at the rear wheel and has intervened to reduce torque. The warning light flashes for longer than ASC/DTC intervention lasts. This affords the rider visual feedback on control intervention even after the critical situation has been dealt with.

## ASC/DTC self-diagnosis not completed



slow-flashes.

Possible cause:

 ASC/DTC self-diagnosis not completed

The ASC/DTC function is not available, because self-diagnosis did not complete. (The motorcycle has to reach a defined minimum speed for the wheel speed sensors to be checked: 5 km/h)

- Pull away slowly. The ASC/DTC indicator and warning light must go out after a few metres. If the ASC/DTC indicator and warning light continues flashing:
- Seek the advice of a specialist workshop, preferably an authorised BMW Motorrad dealer.

### ASC/DTC switched off

 lights up.

Possible cause:

The rider has switched off the ASC/DTC function.

- Switching on ASC/DTC (➡ 71).

### ASC/DTC fault

 lights up.

Possible cause:

The ASC/DTC control unit has detected a fault. The ASC/DTC function is not available.

- You can continue to ride. Bear in mind that the ASC/DTC function is not available. Bear in mind the more detailed information on situations that can lead to a fault (➡ 110).
- Have the fault rectified as quickly as possible by a specialist workshop, preferably an authorised BMW Motorrad dealer.

### ESA fault

– With Dynamic ESA<sup>OE</sup>

 lights up yellow.

 appears on the display.

Possible cause:

The ESA control unit has detected a fault. In this condition, the motorcycle has too much damping and is uncomfortable to drive, especially on roads in poor condition.

- Have the fault rectified as quickly as possible by a specialist workshop, preferably an authorised BMW Motorrad dealer.

### Gear not calibrated

– with Pro shift assistant<sup>OE</sup>

 The gear indicator flashes. The shift assistant Pro is not available.

Possible cause:

– with Pro shift assistant<sup>OE</sup>

The transmission sensor has not been completely calibrated.

- Engage idle position N and run the engine at standstill for a minimum of 10 seconds to calibrate the idle position.
- Use clutch control to engage all gears and ride for a minimum of 10 seconds in each engaged gear.
- » The gear indicator stops flashing once the transmission sensor has been successfully calibrated.
- Once the transmission sensor has been completely calibrated, the shift assistant Pro will operate as described (▣► 116).
- If the calibration process was unsuccessful, have the fault eliminated by a specialist workshop, we recommend a BMW Motorrad Partner.

## Fuel down to reserve



lights up.



### WARNING

#### Irregular engine operation or engine shutdown due to lack of fuel

Risk of accident, damage to catalytic converter

- Do not run the fuel tank dry.◀

Possible cause:

The fuel tank contains no more than the reserve quantity of fuel.



Reserve fuel

approx. 4 l

- Refuelling (▣► 98).

## Service-due indicator

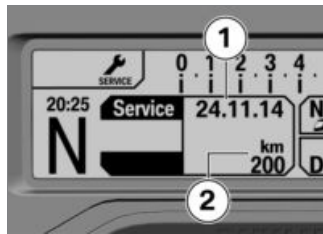

The service-due date **1** shows when a service is due within one month.

When a service is due within 1000 km (US model, 700 miles), countdown distance **2** is shown and counted down in steps of 100 km (US model, 100 miles). This reading appears briefly after the Pre-Ride-Check completes.



If service is overdue, the due date or the odometer reading at which service was due is accompanied by the 'General' warning light showing yellow.

The word "Service" remains permanently visible.

## NOTICE

If the service-due indicator appears more than a month before the service date, the date saved in the instrument cluster must be adjusted. This situation can occur if the battery was disconnected for a prolonged period of time.

If you want to have the date set consult a specialist workshop, preferably an authorised BMW Motorrad dealer. ◀

## Fuel reserve

The amount of fuel present in the fuel tank when the fuel warning light is switched on is dependent on vehicle dynamics. The more the fuel moves inside the tank (due to regularly changing angles of heel, fre-

quent braking and acceleration), the more difficult it becomes to determine the reserve volume. For this reason, the fuel reserve volume cannot be displayed exactly.



After the fuel warning light has switched on, the range is displayed automatically.

The distance that can still be travelled using the reserve volume depends on the style of driving (usage) and the amount of fuel remaining at the time the light came on (see explanation above).

The odometer for the fuel reserve is reset when the amount of fuel after refuelling is greater than the reserve volume.

## Oil level

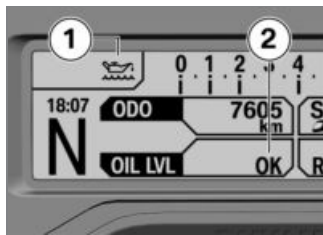

The oil-level indicator **2** gives you an indication of the engine oil level. You can call up this reading only when the vehicle is at a standstill.

The preconditions for the oil level check are as follows:

- Engine at operating temperature.
- Engine idling for at least ten seconds.
- Side stand retracted.

– Motorcycle standing upright on a smooth, level surface.

The readings mean:

OK: oil level is correct.

CHECK: check the oil level the next time you stop for fuel.

---: oil level cannot be measured (conditions as stated above not satisfied).



If the oil level needs to be checked, the symbol **1** is displayed until the oil level is detected as being correct again.

## Ambient temperature

When the motorcycle is at a standstill, the heat of the engine can falsify the ambient-temperature reading. If the effect of the engine's heat becomes excessive, "---" temporarily appears on the display.

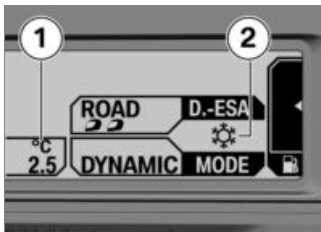

If ambient temperature drops below the threshold a warning appears, drawing your attention to the risk of black ice forming. The display automatically switches from any other mode to temperature reading **1** and the reading flashes when ambient temperature drops below this threshold for the first time.



Threshold for ambient temperature

approx. 3 °C



In addition, the ice crystal symbol **2** is shown.



## WARNING

**Risk of black ice also applicable at over 3 °C**

Risk of accident

- Always take extra care when temperatures are low; remember that there is particular danger of black ice forming on bridges and where the road is in shade. ◀

## Tyre pressure

– with tyre pressure monitoring (RDC)<sup>OE</sup>

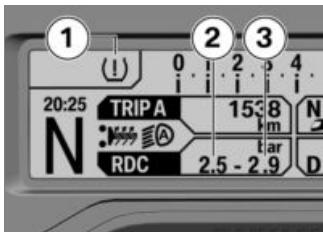

The tyre-pressure readings in the multifunction display are temperature-compensated and are always referenced to the following tyre-air temperature:

20 °C

The front tyre pressure is on the left **2**; the reading on the right **3** is the rear tyre pressure. Immediately after the ignition is switched on "-- --" is displayed.



RDC sensor is not active

min 30 km/h (The RDC sensor does not transmit its signal to the vehicle until a certain minimum speed has been reached.)



If the symbol **1** also shows, this is a warning. The critical tyre pressure flashes.



If the value in question is close to the limit of the permissible tolerance range, the reading is accompanied by the 'General' warning light showing yellow. If the tyre pressure registered by the sensor is outside the permissible tolerance range, the 'General' warning light flashes red.

For more information about BMW Motorrad RDC go to Page (➡ 114).

## Recommendation to upshift

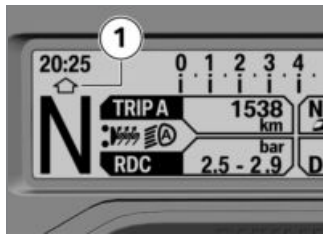

The upshift recommendation **1** signals the economically best point in time for upshift.

## Red rpm range

The red range of the revolution counter changes as a function of engine temperature.

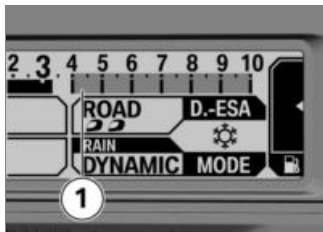

### Engine cold

Red rpm range 1



Engine has not yet reached its operating temperature.

>4000 min<sup>-1</sup>

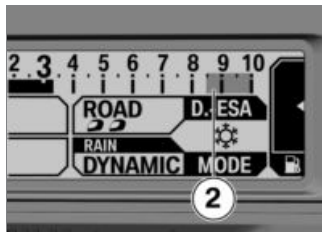

### Engine at operating temperature

Red rpm range 2



Engine has reached its operating temperature.

>8500 min<sup>-1</sup>



## Operation

Ignition.....	48	Cruise-control system .....	76
Ignition with Keyless Ride.....	50	Heated handlebar grips .....	78
Emergency off switch (kill switch).....	55	Front and rear seats .....	79
Lights.....	55		
Daytime riding light .....	57		
Hazard warning lights system .....	59		
Turn indicators.....	60		
Multifunction display .....	60		
Anti-theft alarm (DWA).....	67		
Anti-lock brake system (ABS) .....	69		
Automatic Stability Control (ASC) .....	71		
Electronic Suspension Adjustment (ESA) .....	72		
Riding mode .....	73		

## Ignition Keys

You receive 2 ignition keys. Please consult the information on the electronic immobiliser (EWS) if a key is lost or mislaid (▮▮▮▮ 49). Ignition switch/steering lock, fuel filler cap lock and seat lock are all operated with the same key.

If you wish you can arrange to have the cases and the top-case fitted with locks that can be opened with the ignition key as well. Consult a specialist workshop, preferably an authorised BMW Motorrad dealer.

### Lock the handlebars

- Turn the handlebars all the way to left.



- Turn the key to position **1**, while moving the handlebars slightly.
  - » Ignition, lights and all function circuits switched off.
  - » Handlebars are locked.
  - » Key can be removed.

## Switching on ignition



- Insert the vehicle key into the ignition switch and turn it to position **1**.
  - » Side lights and all function circuits are switched on.
    - with daytime running light<sup>OE</sup>
    - with Pro Headlight<sup>OE</sup>
  - » When the ignition is switched on the daytime riding light comes on briefly (welcome light).<
  - with LED auxiliary headlights<sup>OA</sup>
    - » LED auxiliary headlights are switched on.<

- » Pre-Ride-Check is performed. (►►► 91)
- » ABS self-diagnosis is in progress. (►►► 92)
- » ASC/DTC self-diagnosis is in progress. (►►► 93)

## Switching off ignition

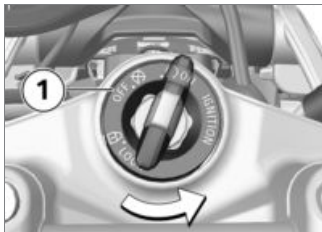

- Turn the ignition key to position **1**.
- » When the ignition is switched off, the instrument cluster remains switched on for a short time and displays any existing fault messages.
- » Handlebars not locked.

- » Electrically powered accessories remain operational for a limited period of time.
- » The battery can be recharged via the socket.
- » Key can be removed.

- with daytime running light<sup>OE</sup>
- with Pro Headlight<sup>OE</sup>
  - The daytime riding light goes out soon after the ignition is switched off.◀
- with LED auxiliary headlights<sup>OA</sup>
  - The LED auxiliary headlights go out soon after the ignition is switched off.◀

## Electronic immobiliser EWS

The electronic design of the motorcycle allows it to access data stored in the ignition key by means of a ring antenna located in the ignition switch/steering lock. The engine control unit

will not permit the engine to be started unless the key is identified as “authorised”.



### NOTICE

A spare vehicle key attached to the same ring as the ignition key used to start the engine could impair operation of the electronics, in which case the enabling signal for starting is not issued. The warning with the key symbol appears in the multifunction display.

Always keep the spare key separately from the ignition key.◀

If you lose your key, you can have it barred by your authorised BMW Motorrad dealer. If you wish to do this, you will need to bring all other keys for the motorcycle with you. The engine cannot be started by a barred key, but a key that has

been barred can subsequently be reactivated.

You can obtain emergency/extra keys only through an authorised BMW Motorrad dealer. The keys are part of an integrated security system, so the dealer is under an obligation to check the legitimacy of all applications for replacement/extra keys.

## Ignition with Keyless Ride

– with Keyless Ride<sup>OE</sup>

### Keys



#### NOTICE

The telltale light for the radio-operated key flashes while the search for the radio-operated key is in progress.

The telltale light goes out as soon as the radio-operated key or the emergency key is found.

The telltale light goes out briefly if the search times out without the radio-operated key or the emergency key being found.◀

You receive one radio-operated key and one emergency key. Please consult the information on the electronic immobiliser (EWS) if a key is lost or mislaid (▣▣▣ 52). Ignition, fuel filler cap and anti-theft alarm system all work with the radio-operated key. Seat lock, topcase and cases can be locked and unlocked manually.



#### NOTICE

The vehicle cannot be started if the radio control key is not within range (e.g. key inside one of the cases or the topcase). If the radio-operated key remains out of range the ignition is switched off after about 1.5 minutes to protect the battery.

It is advisable to keep the radio-operated key on your person (e.g. in a jacket pocket) and to have the emergency key with you as an alternative.◀



Range of the Keyless Ride radio-operated key

– with Keyless Ride<sup>OE</sup>

approx. 1 m◀

## Lock the handlebars Requirement

The handlebars are turned towards the left. Radio-operated key is within range.



- Press and hold down button **1**.
  - » The steering lock engages with an audible click.
  - » Ignition, lights and all function circuits switched off.
- Short-press button **1** to disengage the steering lock.

## Switching on ignition

### Requirement

Radio-operated key is within range.

- There are **two** ways of activating the ignition.

### Version 1:

- Short-press button **1**.
  - » Side lights and all function circuits are switched on.
    - with daytime running light<sup>OE</sup>
    - with Pro Headlight<sup>OE</sup>
  - » Daytime riding light is switched on.<
  - with LED auxiliary headlights<sup>OA</sup>
  - » LED auxiliary headlights are switched on.<
  - » Pre-Ride-Check is performed. (▣▣▣ 91)

- » ABS self-diagnosis is in progress. (▣▣▣ 92)
- » ASC/DTC self-diagnosis is in progress. (▣▣▣ 93)

### Version 2:

- Steering lock is engaged; press and hold down button **1**.
  - » The steering lock disengages.
  - » Parking lights and all function circuits switched on.
  - » Pre-Ride-Check is performed. (▣▣▣ 91)
  - » ABS self-diagnosis is in progress. (▣▣▣ 92)
  - » ASC/DTC self-diagnosis is in progress. (▣▣▣ 93)

## Switching off ignition

### Requirement

Radio-operated key is within range.



- There are **two** ways of deactivating the ignition.

#### Version 1:

- Short-press button **1**.
  - » Light is switched off.
  - » Handlebars (steering lock) are not locked.

#### Version 2:

- Turn the handlebars all the way to left.
- Press and hold down button **1**.
  - » Light is switched off.
  - » The steering lock engages.

## Electronic immobiliser EWS

The on-board electronics access the data saved in the radio-operated key via a ring aerial. The ignition is not enabled for starting until the engine control unit has recognised the radio-operated key as "authorised" for your motorcycle.



### NOTICE

A spare vehicle key attached to the same ring as the radio-operated key used to start the engine could impair operation of the electronics, in which case the enabling signal for starting is not issued. The warning with the key symbol appears in the multifunction display.

Always keep the spare key separately from the radio-operated key. ◀

If you mislay a radio-operated key you can have the key in question barred by your authorised BMW Motorrad dealer. In order to have a key barred you must bring along all the other keys belonging to the motorcycle.

The engine cannot be started by a barred radio-operated key, but a radio-operated key that has been barred can subsequently be reactivated.

You can obtain emergency/extra keys only through an authorised BMW Motorrad dealer. The radio-operated keys are part of an integrated security system, so the dealer is under an obligation to check the legitimacy of all applications for replacement/extra keys.

## Loss of the radio-operated key

### NOTICE

Note the information on the electronic immobiliser (EWS) if a key is lost or mislaid.

If you happen to lose the radio-operated key during the journey, you can start the vehicle using the emergency key. ◀

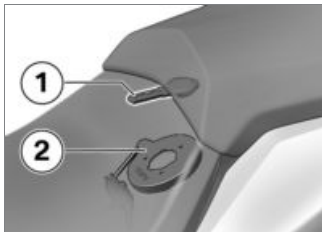

- Insert emergency key **1** into the slot between front seat and rear seat, in such a way that the emergency key is positioned above aerial **2**.



Time during which the engine has to be started. The unlocking procedure has to be repeated if this time is allowed to expire.

30 s

- » Pre-Ride-Check is performed.
- Emergency key has been recognised.
- Engine can be started.
- Emergency key can be removed.
- Start engine (▶▶▶ 91).

## Battery of the radio-operated key is empty

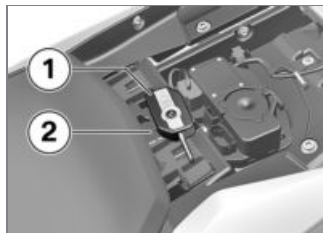

- Removing rear seat (▶▶▶ 79).
- Lay radio-operated key **1** in position **2**.



Time during which the engine has to be started. The unlocking procedure has to be repeated if this time is allowed to expire.

30 s

- Switch on the ignition.
- » Pre-Ride-Check is performed.
- Radio-operated key has been recognised.

- Engine can be started.
- Radio-operated key can be removed.
- Start engine (☰→ 91).
- Install the rear seat (☰→ 79).

## Replace the battery of the radio-operated key

If the radio-operated key does not react when you short-press or long-press a button:

- The battery in the radio-operated key is not at full capacity.
- » Change the battery.

 appears on the display.

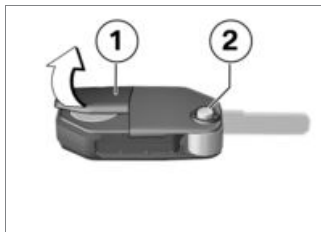

- Press button **2**.
- » Bitting key flips out.
- Push up battery cover **1**.

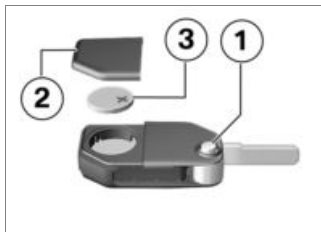

- Remove battery **3**.



Battery type

For Keyless Ride-radio-operated key

CR 2032

- Dispose of the old battery in accordance with all applicable laws and regulations; do not attempt to dispose of batteries as domestic waste.



## ATTENTION

### Unsuitable or incorrectly inserted batteries

Component damage

- Use a battery compliant with the manufacturer's specifications.
- When inserting the battery, always make sure polarity is correct. ◀
- Insert new battery **3** with the positive terminal up.



- Install battery cover **2**.
- Press button **1** and fold the bitted key closed.
- » The remote control is again ready for use.

## Emergency off switch (kill switch)



- 1** Emergency off switch (kill switch)

### WARNING

#### Operation of the kill switch while riding

Risk of fall due to rear wheel locking

- Do not operate the kill switch when riding. ◀

The emergency off switch is a kill switch for switching off the engine quickly and easily.

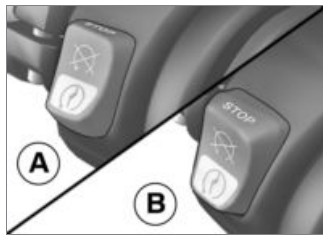

- A** Engine switched off  
**B** Normal operating position (run)

## Lights

### Low-beam headlight and sidelights

The side lights switch on automatically when the ignition is switched on.

#### NOTICE

The side lights place a strain on the battery. Do not switch the ignition on for longer than absolutely necessary. ◀

The low-beam headlight switches on automatically when the engine is started.

– with daytime running light<sup>OE</sup>  
 In daytime the daytime riding light can be switched on as an alternative to the low-beam headlight.

## High-beam headlight and headlight flasher

- Switching on ignition (➡ 48).

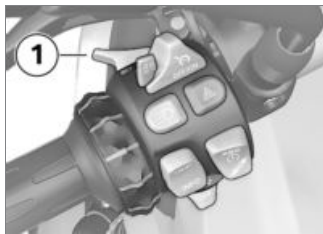

- Push switch **1** forward to switch on the high-beam headlight.
- Pull switch **1** back to operate the headlight flasher.

## Headlight courtesy delay feature

- Switch off the ignition.

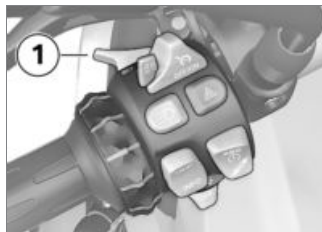

- Immediately after having switched off the ignition, pull the switch **1** towards the rear and hold it until the delayed headlight switch-off has switched on.
  - » The vehicle lights light up for one minute before they are automatically switched off.
  - For instance, use this feature to light up the way to the front door after having parked the vehicle.

## Parking lights

- Switching off ignition (➡ 49).



- Immediately after switching off the ignition, push button **1** to the left and hold it in this position until the parking lights come on.
- Switch the ignition on and off again to switch off the parking lights.

## LED auxiliary headlights

- with LED auxiliary headlights<sup>OA</sup>

## Requirement

Daytime riding light is switched off. Low-beam headlight is active.

## NOTICE

The auxiliary headlights have approval as fog lights and their use is permissible in bad weather conditions only. Always comply with the road traffic regulations in force in the country in which the vehicle is used. ◀

- Start engine (▶▶▶ 91).



- Press button **1** to switch on the LED auxiliary headlights.

 The indicator light for the auxiliary headlight illuminates.

- Press button **1** again to switch off the LED auxiliary headlights.

## Daytime riding light Manual daytime riding light

- with daytime running light<sup>OE</sup>
- with Pro Headlight<sup>OE</sup>

### Requirement

Automatic daytime riding lights are switched off.

## WARNING

### Activation of daytime riding light in the dark.

Poorer vision and oncoming traffic dazzled.

- Do not use the daytime running light when it is dark. ◀

## NOTICE

By comparison with the low-beam headlight, the daytime

running light makes the vehicle more visible to oncoming traffic. This improves daytime visibility. ◀

- Start engine (▶▶▶ 91).

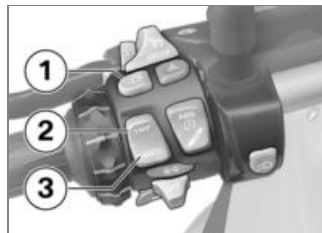

- Repeatedly short-press button **2** until the **SETUP** menu appears on the display.
- Press and hold down button **2** to call up the **SETUP** menu.
- Repeatedly short-press button **2** until **Auto. DRL** appears on the display.
- Press button **3** to switch automatic daytime riding light **OFF**.

- Press button **1** to switch on the daytime riding light.



The symbol appears on the display.

- » The low-beam headlight, the front side lights and the auxiliary headlights are switched off.
- In the dark or in tunnels: Press button **1** again to switch off the daytime riding light and switch on the low-beam headlight and the front side lights. The auxiliary headlight is also switched on again.



#### NOTICE

If you switch on the high-beam headlight on while the daytime running light is on, the daytime riding light is switched off after approx. 2 seconds and the high-beam headlight, low-beam headlight, front side lights and, if applicable, the auxiliary headlights are switched on.

If the high beam headlight is switched off again, the daytime riding light is not automatically reactivated, but must be switched on again if required.◀

### Automatic daytime riding light

– with daytime running light<sup>OE</sup>



#### NOTICE

The changeover between daytime running light and low beam headlight including front side lights can be effected automatically.◀



#### WARNING

**The automatic riding light control system cannot replace your personal assessment of lighting conditions, particularly in foggy or misty weather.**

Safety risk

- Manually switch on the low-beam headlight in poor lighting conditions.◀
- Repeatedly short-press button **1** until the **SETUP** menu appears on the display.

- Press and hold down button **1** to call up the **SETUP** menu.
- Repeatedly short-press button **1** until **Auto . DRL** appears on the display.

- Press button **2** to switch automatic daytime riding light **ON**.

 The indicator light for the automatic daytime riding light illuminates.

- » If the ambient brightness decreases below a certain value, the low beam headlight is automatically switched on (e. B. in a tunnel). When sufficient ambient brightness is detected, the daytime riding light is switched back on. When the daytime riding light is active, the daytime riding light symbol is displayed in the multifunction display.

## Manual operation of the light when the automatic system is switched on

- with daytime running light<sup>OE</sup>
- If you press the button for the daytime riding light, the automatic daytime riding light is switched off and the low-beam headlight and front side lights are switched on (e. g. when you ride into a tunnel, and the response of the automatic daytime riding light to the change in ambient brightness is delayed). The auxiliary headlight switches on again when the daytime riding light is switched off.
- If you press the button again the automatic daytime riding light is reactivated, in other words the daytime riding light is switched on again when ambient light is bright enough.

## Hazard warning lights system

### Operating hazard warning flashers

- Switching on ignition (☰➔ 48).



#### NOTICE

The hazard warning flashers place a strain on the battery. Do not use the hazard warning flashers for longer than absolutely necessary.◀



#### NOTICE

If you press a turn-indicator button with the hazard warning flashers switched on, the turn-indicator function is activated instead of the hazard warning flashers, and remains active until you release the button. The hazard warning flashers recommence flashing as soon as the button is released.◀



- Press button **1** to switch on the hazard warning flashers.  
» Ignition can be switched off.
- To switch off the hazard warning flashers, switch on the ignition and press button **1** again.

## Turn indicators

### Operating the turn indicators

- Switching on ignition (➡ 48).



- Push button **1** to the left to switch on the left turn indicators.
- Push button **1** to the right to switch on the right turn indicators.
- Centre button **1** to cancel the turn indicators.



### NOTICE

The turn indicators are cancelled automatically after the defined time and distance. The defined time and distance can be set by an authorised BMW Motorrad dealer. ◀

## Multifunction display Assistance with menu guidance

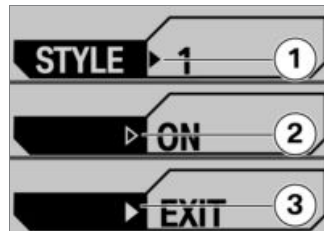

The meanings of the arrows that appear on the display are as follows:

- Arrows **1** and **3**: Press and hold down the corresponding button.
- Arrow **2**: Short-press the corresponding button.

### Selecting individual display view

- Switching on ignition (➡ 48).

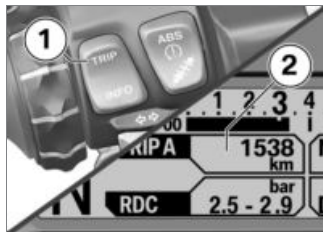

- Repeatedly short-press button **1** until **STYLE** appears in bottom display line **2**.
- Press and hold down button **1** to change the Display view. The meanings of the numbers are as follows:
  - **0**: Full view
  - **1**: Sport view
  - **2**: Touring view
- » Area **2** shows which Display view has been selected.

### Select readings in on-board computer

- Switching on ignition (🔌➔ 48).

- Short-press button **1** to select the reading in top display line **2**.  
In the standard equipment the following values can be displayed and selected at the press of a button:
  - Tripmeter 1 (TRIP 1)
  - Tripmeter 2 (TRIP 2)
  - Range (RANGE)
  - Total distance travelled (ODO)
  - SETUP-menu (SETUP), only when stationary

- with Pro onboard computer<sup>OE</sup>
- The following information is additionally displayed by means of the on-board computer Pro:
- Automatic trip distance TRIP A
  - Current consumption (CONS.)◀

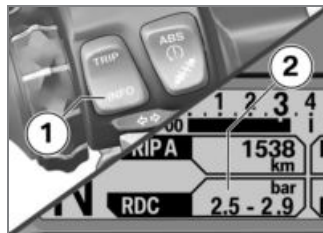

- Short-press button **1** to select the reading in bottom display line **2**.  
In the standard equipment the following values can be displayed and selected at the press of a button:

- Ambient temperature (TEMP.)
- Engine temperature (ENG. T.)
- Range (RANGE)
- Average consumption 1 (CONS 1)
- Average consumption 2 (CONS 2)
- Average speed (SPEED)
- with tyre pressure monitoring (RDC)<sup>OE</sup>
- Tyre pressures (RDC)◁
- Date (DATE)
- Oil-level reminder (OIL LVL)
- with Pro onboard computer<sup>OE</sup>
- Vehicle circuit voltage (VOLTG.)◁
- with Pro onboard computer<sup>OE</sup>
- Stopwatch total time (T. TOT.)◁
- with Pro onboard computer<sup>OE</sup>
- Stop watch driving time (T. RIDE)◁

## Resetting trip distance recorder

- Switching on ignition (➡ 48).

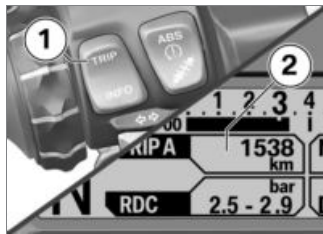

- Repeatedly short-press button **1** until the trip distance recorder to be reset appears in top display line **2**.
- Press and hold down button **1** until the value shown is reset.

## Resetting the average values

- Switching on ignition (➡ 48).

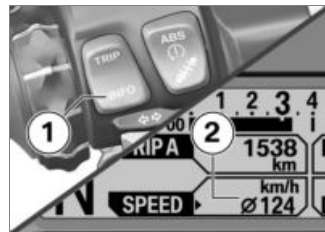

- Repeatedly short-press button **1** until the average value to be reset appears in bottom display line **2**.
- Press and hold down button **1** until the value shown is reset.

## Configure the on-board computer

### Requirement

The vehicle is at a standstill.

- Switching on ignition (➡ 48).



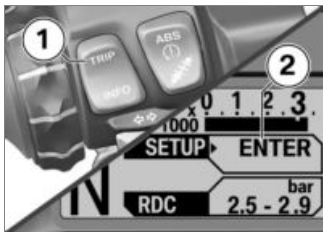

- Repeatedly short-press button **1** until top display line **2** shows SETUP ENTER.
- Press and hold down button **1** to start the SETUP menu.
- » The following indication in the display depends on the equipment selected.

- Short-press button **1** to go to the next menu item in the sequence.
  - » The top display line **2** shows the menu item.
  - » The bottom display line **3** shows the preset value.
- Short-press button **4** to change the setting.

The following menu items can be selected:

- with alarm system (DWA)<sup>OE</sup>
- Auto. Alarm: Switch alarm system ON or OFF<

- with preparation for navigation system<sup>OE</sup>
- GPS Time: Navigation system installed: Accept GPS time and GPS date (ON) or do not accept (OFF)<
- with Pro riding modes<sup>OE</sup>
- User Mode: User-specific settings for the riding mode.<
- Clock: Setting the clock
- Date: Setting the date
- Shift Indicator: Display upshift recommendation in the display (ON) or not (OFF)
- Brightn.: Set display brightness, from normal (0) to bright (5)
- Clock Format: Setting the format for the time reading
- Date Format: Setting the format for the date reading
- with daytime running light<sup>OE</sup>
- Auto. DRL: Switch daytime riding light ON or OFF<

- with Pro onboard computer<sup>OE</sup>
- BC: Toggle between BC Pro and BC Basic $\triangleleft$
- RESET!: Reset all settings.
- EXIT: Exit SETUP menu

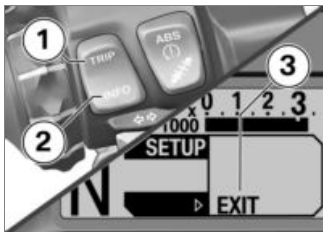

- To exit the SETUP menu with the EXIT menu item **3** selected, short-press button **2**.
- To exit the SETUP menu at any point, press and hold down button **1**.

## Setting the clock

- Switching on ignition (➡ 48).



## WARNING

### Adjusting the clock while riding

Risk of accident

- Set the clock only when the motorcycle is stationary.  $\triangleleft$
- In the SETUP menu, select the menu item CLOCK.

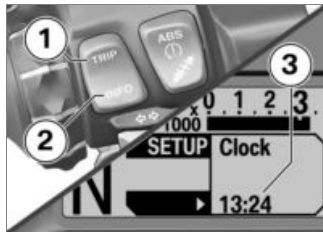

- Press and hold down button **2** until the hours in the bottom display line **3** flash.



## NOTICE

If "-- : --" is displayed instead of the time, the voltage supply of the instrument cluster has been interrupted (e.g. by disconnecting the battery).  $\triangleleft$

- Press button **1** to increase the flashing value or button **2** to reduce the same.
- Press and hold down button **2** until the minutes in the bottom display line **3** flash.
- Press button **1** to increase the flashing value or button **2** to reduce the same.
- Press and hold button **2** until the minutes number stops flashing.
- » Setting is complete.
- You can cancel the procedure at any time by pressing and holding down button **1** until the initial value reappears.

## NOTICE

If you drive off before the setting has been completed, the setting will be cancelled.◀

### Setting the date

- Switching on ignition (▣▣▣ 48).
- In the SETUP menu, select the menu item DATE.

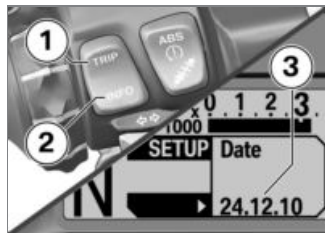

- Press and hold down button **2** until the day in the bottom display line **3** starts to flash.

## NOTICE

If "-- . -- . --" is displayed instead of the date, the voltage supply of the instrument cluster has been interrupted (e.g. by disconnecting the battery).◀

- Press button **1** to increase the flashing value or button **2** to reduce the same.
- Press and hold down button **2** until the month in the bottom display line **3** starts to flash.
- Press button **1** to increase the flashing value or button **2** to reduce the same.
- Press and hold down button **2** until the year in the bottom display line **3** starts to flash.
- Press button **1** to increase the flashing value or button **2** to reduce the same.
- Press and hold down button **2** until the year stops flashing.  
» Setting is complete.

- You can cancel the procedure at any time by pressing and holding down button **1** until the initial value reappears.

## NOTICE

If you drive off before the setting has been completed, the setting will be cancelled.◀

### Customising the display

– with Pro onboard computer<sup>OE</sup>

- Switching on ignition (▣▣▣ 48).

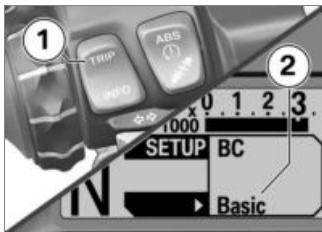

- In the **SETUP** menu, press button **1** to select the **BC** menu item **2**.



- Short-press button **1** to change to **BC Pro 2** (individualisation menu).

» In the customisation menu, it is possible to set which information is to be displayed in which display line.

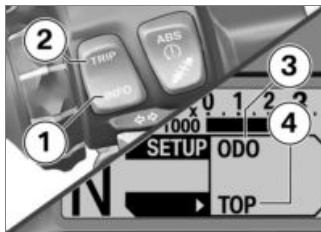

- Press and hold down button **1** to display the first menu item.
  - » ODO appears on the display.
- Short-press button **2** to go to the next menu item in the sequence.
  - » The top display line **3** shows the menu item.
  - » The bottom display line **4** shows the preset value. The following values can be set.

- **TOP**: The value is displayed in the top display line.
  - **BOTTOM**: The value is displayed in the bottom display line.
  - **BOTH**: The value is displayed in both display lines.
  - **OFF**: The value is not displayed.
  - Short-press button **1** to change the setting.
- The following menu items can be selected, the works setting is shown in brackets. Some menu items will only be selected if the relevant special equipment (OE) is actually present.
- **ODO**: Total mileage counter (TOP, the setting **OFF** is not possible)
  - **TRIP 1**: Tripmeter 1 (TOP)
  - **TRIP 2**: Tripmeter 2 (TOP)
  - **TRIP A**: Automatic tripmeter (TOP)

- TEMP .: Ambient temperature (BOTTOM)
- ENG . T .: Engine temperature (BOTTOM)
- RANGE: Range (TOP)
- CONS . 1: Average consumption 1 (BOTTOM)
- CONS . 2: Average consumption 2 (BOTTOM)
- CONS .: Current consumption (TOP)
- SPEED: Average speed (BOTTOM)
- RDC: Tyre pressures (BOTTOM)
- VOLTG .: Vehicle circuit voltage (BOTTOM)
- T . TOT .: Stopwatch total time (BOTTOM)
- T . RIDE: Stopwatch driving time (BOTTOM)
- DATE: Date (BOTTOM)
- SRV . 1: Date of the next service (OFF)
- SRV . 2: Countdown distance to next service (OFF)
- OIL LVL: Oil level note (BOTTOM)
- EXIT: Exit individualisation menu.

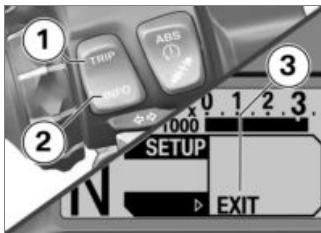

- To exit the individualisation menu with the EXIT menu item **3** selected, short-press button **2**.
- To exit the individualisation menu at any point, press and hold down button **1**.
- » All settings made until then will be saved.

## Anti-theft alarm (DWA)

- with alarm system (DWA)<sup>OE</sup>

### Alarm signal

A DWA alarm can be triggered by:

- motion sensor
- an attempt to use an unauthorised vehicle key to switch on the ignition
- disconnection of the DWA anti-theft alarm from the motorcycle's battery (DWA internal battery in the anti-theft alarm provides power - alarm tone only, the turn indicators do not flash)

All functions are sustained even if the internal battery of the DWA anti-theft alarm system is flat; the only difference is that an alarm cannot be triggered if the system is disconnected from the motorcycle's battery.



Duration of the alarm

26 s (While an alarm is in progress an alarm tone sounds and the turn indicators flash. The type of alarm tone can be set by an authorised BMW Motorrad dealer.)

If an alarm was triggered while the motorcycle was unattended, the rider is notified accordingly by an alarm tone sounding once when the ignition is switched on. The DWA LED then indicates the reason for the alarm for one minute.

### Light signals issued by the DWA LED:

- Flashes 1x: Motion sensor 1
- Flashes 2x: Motion sensor 2
- Flashes 3x: Ignition switched on with unauthorised vehicle key

- Flashes 4x: Disconnection of the DWA anti-theft alarm from the motorcycle's battery
- Flashes 5x: Motion sensor 3

### DWA adjusting

- Switching on ignition (➡ 48).

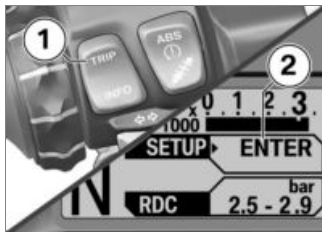

- Repeatedly short-press button **1** until top display line **2** shows ENTER.
- Press and hold down button **1** to start the SETUP menu.



- Repeatedly short-press button **1** to select the Auto. Alarm menu item.
  - » In the top display line **2**, Auto. Alarm is displayed.
  - » The bottom display line **3** shows the preset ON/OFF value.
- Short-press button **4** to change the setting. The following settings are available:
  - ON: The DWA anti-theft alarm is active and will be armed automatically when the ignition is switched off.

- OFF: The DWA anti-theft alarm is deactivated.

## DWA Activating

- Switching on ignition (▣ 48).
- DWA adjusting (▣ 68).
- Switch off the ignition.
- » DWA If the alarm system (DWA) is activated, then the alarm system will be armed automatically when the ignition is switched off.
- » Activation takes approximately 30 seconds to complete.
- with Keyless Ride<sup>OE</sup>

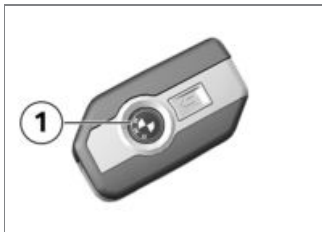

- Short-press button **1**.

- » Turn indicators flash twice.
- » Confirmation tone sounds twice (if programmed).
- » Anti-theft alarm (DWA) is active.

## DWA Deactivating

- Switch on the ignition.
- with Keyless Ride<sup>OE</sup>

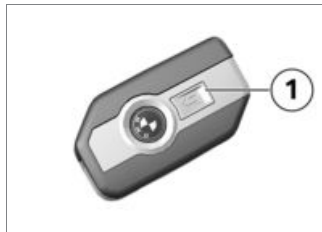

- Short-press button **1**.
- » Turn indicators flash once.
- » Confirmation tone sounds once (if programmed).
- » Anti-theft alarm (DWA) is deactivated.

## Anti-lock brake system (ABS)

### ABS Switching off

#### NOTICE

See the section entitled "Engineering details" for more information on brake systems with BMW Motorrad Integral ABS. ◀

- Switching on ignition (▣ 48).

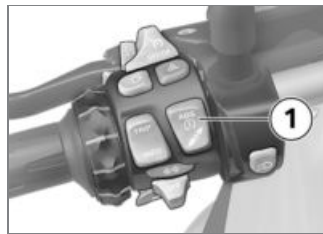

- Press and hold the **1** button until the ABS indicator and warning light display changes.

## NOTICE

You have the option of deactivating the ABS function while the motorcycle is on the move. ◀

» Initially, the ASC/DTC symbol changes status. Press and hold the **1** button until the ABS indicator and warning light reacts. Under these circumstances, there is no change in the ASC/DTC setting.



lights up.

- Release button **1** within two seconds.



remains lit.

» The ABS is deactivated, but the integral function remains active.

## ABS Switching on

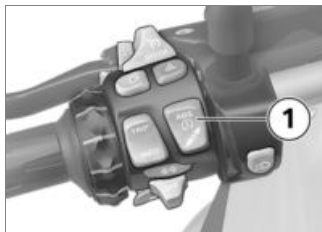

- Press and hold the **1** button until the ABS indicator and warning light display changes.



## NOTICE

You have the option of activating the ABS function while the motorcycle is on the move. ◀



goes out. If self-diagnosis has not completed, the indicator and warning light starts flashing.

- Release button **1** within two seconds.



remains off or continues to flash.

» Anti-theft alarm (ABS) is switched on.

- You also have the option of switching the ignition off and then on again.



ABS fault

An ABS fault has occurred if the ABS telltale and warning light shows when the motorcycle accelerates to a speed in excess of the minimum stated below after the ignition was switched off and then on again. (Minimum speed: 5 km/h)



## Automatic Stability Control (ASC)

### Switching off ASC/DTC

#### NOTICE

See the section entitled "Engineering details" for more information on ASC and DTC. ◀

- Switching on ignition (▮▮▮ 48).

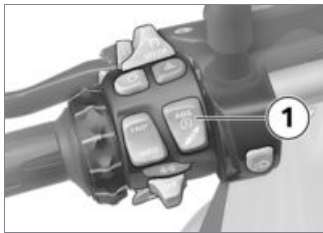

- Press and hold the **1** button until the ASC/DTC indicator and warning light display behaviour changes.

#### NOTICE

You have the option of deactivating the ASC/DTC function while the motorcycle is on the move. ◀

 lights up.

- Release button **1** within two seconds.

 remains lit.

» ASC/DTC is switched off.

### Switching on ASC/DTC

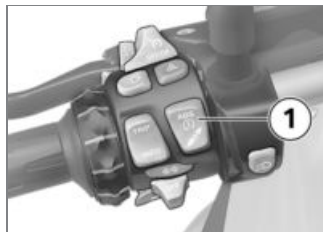

- Press and hold the **1** button until the ASC/DTC indicator and warning light display behaviour changes.

#### NOTICE

You have the option of activating the ASC/DTC function while the motorcycle is on the move. ◀

 goes out. If self-diagnosis has not completed the indicator and warning light starts flashing.

- Release button **1** within two seconds.



remains off or continues to flash.

- » ASC/DTC is switched on.
- You also have the option of switching the ignition off and then on again.



ASC/DTC fault

If the ASC/DTC indicator and warning light continues to show after switching the ignition off and back on, and accelerating the motorcycle to a speed above the minimum, an ASC/DTC fault exists. (Minimum speed: 5 km/h)

## Electronic Suspension Adjustment (ESA)

– With Dynamic ESA<sup>OE</sup>

### Dynamic ESA Possible settings

Dynamic ESA enables you to adjust your motorcycle's suspension to suit the load and the road conditions.

By interpreting ride height sensor signals, Dynamic ESA detects movements in the chassis and suspension and responds by adjusting the damper valves. The chassis and suspension will thus be adapted to the characteristics of the terrain.

You can set the damping to a harder (DYNAMIC) setting than the basic setting (ROAD). Dynamic ESA calibrates itself at regular intervals when stationary with the engine running to ensure the correct operating principle of the system. During this calibration, chassis and suspension adjustment is not possible.

### Adjusting the chassis and suspension

- Switching on ignition (➡ 48).

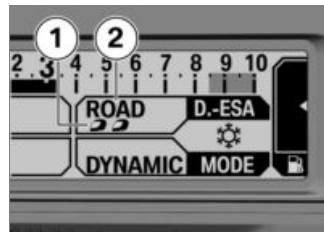

In the multifunction display the spring preload is shown in area **1** and the damping in area **2**.

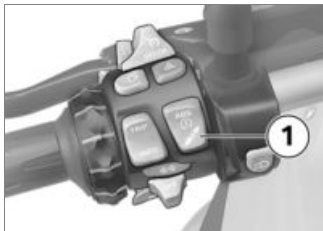

To adjust spring preload:

- Start engine (▶▶▶ 91).
- Press and hold down button **1** until the setting you want to use appears on the display.

### NOTICE

You cannot adjust spring preload while the motorcycle is on the move.◀

The following settings are available:



One-up



One-up with luggage



Two-up (with luggage)

- Wait for the mechanism to complete all adjustments before you ride off.
- » The settings for damping and spring preload shown on the

To adjust damping:

- Repeatedly press button **1** until the setting you want to use appears on the display.

### NOTICE

You can adjust the damping characteristic while the motorcycle is on the move.◀

The following settings are available:

- ROAD: Comfortable damping characteristic
- DYNAMIC: Sporty damping characteristic

display are automatically accepted if you allow a certain length of time to pass without pressing button **1**. The ESA indicator flashes while adjustment is in progress.

- If the temperature is low, take the weight off the motorcycle before increasing spring preload; if applicable, have your passenger dismount.

## Riding mode

### Using the riding modes

### NOTICE

See the section entitled "Engineering details" for more information on the various ride modes that can be selected.◀

BMW Motorrad has developed 3 operational scenarios for your motorcycle from which you can select the scenario suitable for your situation:

- Riding on a rain-wet road surface.
- Riding on a dry road surface.
- with Pro riding modes<sup>OE</sup>
- Sporty riding on a dry road surface.

The interplay of engine torque, throttle response ASC/DTC control is optimised for each of these 3 scenarios.

### Setting riding mode

- Switching on ignition (➡ 48).



- Press button **1**.

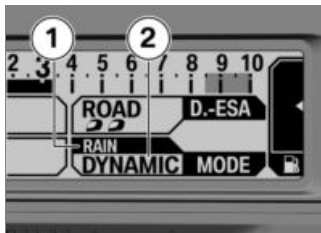

The current setting is shown at position **2**. Each time the button is pressed one of the possible riding modes appears at position **1**.



- Repeatedly press button **1** until the riding mode you want appears on the display.

The following ride modes can be selected:

- RAIN: For riding on a rain-wet road surface.
- ROAD: For riding on a dry road surface.
- with Pro riding modes<sup>OE</sup>
  - » The following riding modes are additionally available for selection:
- DYNAMIC: For dynamic riding on a dry road surface.

– USER: User-specific settings for the riding mode.◀

- Select the riding mode.
  - » With the motorcycle at a standstill, the selected mode is activated after approximately two seconds.
  - » The newly selected riding mode is activated as you ride only if the throttle twistgrip is returned to the idle position and the brakes are not applied.
  - » The riding mode selected in this way is retained, with the engine-characteristic and ASC/DTC adaptation settings, even after the ignition has been switched off.

## Individualising riding mode

– with Pro riding modes<sup>OE</sup>

- Select the USER riding mode.

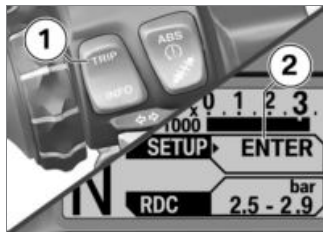

- Repeatedly press button **1** briefly until the top display line shows **2** SETUP ENTER.
- Press and hold down button **1** to start the SETUP menu.



- Repeatedly short-press button **1** until area **2** of the display shows User Mode ENTER.
- Press and hold down button **3** to exit the User mode.

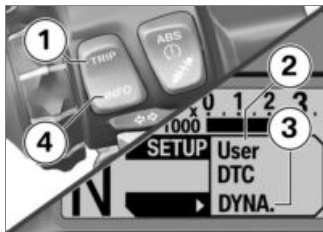

- Press button **1** briefly in order to go to the next menu item.
- » Top display line **2** enables you to choose between the following menu items:
  - ENGINE
  - DTC
- Repeatedly short-press button **4** until the value you want appears in bottom display line **3**.
- Repeatedly short-press button **1** until `User EXIT` appears on the display.
- Press and hold down button **4** to exit the `User` menu.

## Cruise-control system

– with cruise control<sup>OE</sup>

### Switching on cruise control



- Slide switch **1** to the right.
- » Button **2** is enabled for operation.

## Saving road speed



- Briefly push button **1** forward.

 Adjustment range for cruise control

20...210 km/h



Telltale light for cruise control lights up.

- » The motorcycle maintains your current cruising speed and the setting is saved.

## Accelerating



- Briefly push button **1** forward.
  - » The speed is increased by 2 km/h each time the button is pushed.
- Push button **1** forward and hold it in this position.
  - » The motorcycle accelerates steplessly.
  - » The current speed is maintained and saved if button **1** is not pushed again.

## Decelerating



- Briefly push button **1** back.
  - » The speed is reduced by 2 km/h each time you push the button.
- Push button **1** back and hold it in this position.
  - » The motorcycle decelerates steplessly.
  - » The current speed is maintained and saved if button **1** is not pushed again.

## Deactivating cruise control

- Brake, pull the clutch lever or turn the throttle twistgrip (close the throttle by turning the twistgrip back past the idle position) to deactivate the cruise-control system.



### NOTICE

Whenever the Pro shift assistant shifts gears, cruise control is automatically disengaged for safety reasons.◀



### NOTICE

For safety reasons, cruise control is deactivated automatically when the ASC and DTC systems intervene.◀

- » Telltale light for cruise control goes out.

## Resuming former cruising speed



- Briefly push button **1** back to return to the speed saved beforehand.

### NOTICE

Opening the throttle does not deactivate the cruise-control system. If you release the twistgrip the motorcycle will decelerate only to the cruising speed saved in memory, even though you might have intended slowing to a lower speed.◀



Telltale light for cruise control lights up.

## Switching off cruise control



- Slide switch **1** to the left.
  - » The system is deactivated.
  - » Button **2** is disabled.

## Heated handlebar grips

– with heated handlebar grips<sup>OE</sup>

## Operating the heated handlebar grips



### NOTICE

The heating in the heated handlebar grips can be activated only when the engine is running.◀



### NOTICE

The increase in power consumption caused by having the heated handlebar grips switched on can drain the battery if you are riding at low engine speeds. If the charge level is low, the heated handlebar grips are switched off to ensure the battery's starting capability.◀

- Start engine (▶▶▶ 91).



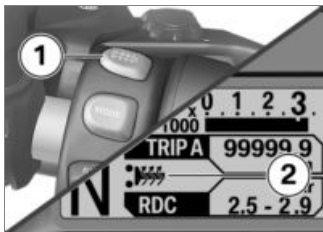

- Repeatedly press button **1** until desired heating stage **2** appears on the display.

The handlebar grips have two-stage heating.

 **First heating stage**  
50 % heating power

 **Second heating stage**  
100 % heating power

- » The second heating stage is for heating the grips quickly: subsequently one should switch back to the first stage.
- » The selected heating stage will be saved if you allow a certain

length of time to pass without making further changes.

- To switch off the heated handlebar grips, press button **1** until heated handlebar grip symbol **2** disappears.

## Front and rear seats

### Removing rear seat

- Make sure the ground is level and firm and place the motorcycle on its stand.

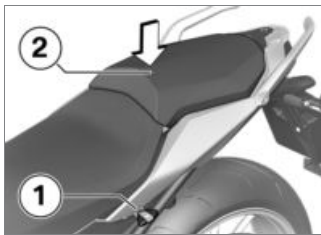

- Press down on the front part of rear seat **2** and at the same time turn seat lock **1** to the left

with the vehicle key and hold it in this position.

- Lift rear seat **2** at the front and release the vehicle key.
- Remove rear seat **2** and place it, upholstered side down, on a clean surface.

### Installing rear seat

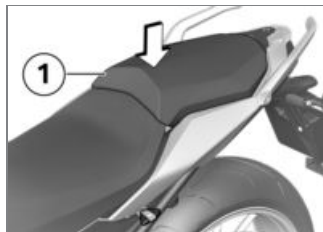

- Begin by slipping rear seat **1** into the mounts at the back.
- Press down firmly on rear seat **1** at the front.
- » The rear seat engages with an audible click.

## Removing front seat

- Removing rear seat (▶▶▶ 79).

Front seat is unlocked.

- Work the front seat to the rear to remove and place it, upholstered side down, on a clean surface.

## Installing front seat

- Removing rear seat (▶▶▶ 79).



- Push the front seat all the way into front mounts **1** and then lower it into position at the back.

## **Adjustment**

Mirrors .....	82
Headlight .....	82
Clutch .....	83
Brakes .....	84
Spring preload .....	84
Damping .....	85

## Mirrors

### Adjusting mirrors



- Turn the mirror to the desired position.

### Adjusting mirror arm

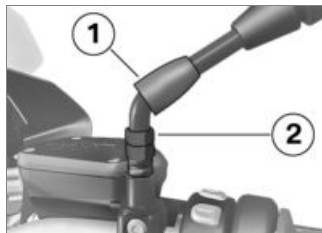

- Push protective cap **1** up over the threaded fastener on the mirror arm.
- Slacken nut **2**.
- Turn the mirror arm to the appropriate position.
- Tighten the nut to the specified tightening torque, while holding the mirror arm to ensure that it does not move out of position.



Mirror (locknut) to adapter

22 Nm (Left-hand thread)

- Push protective cap **1** over the threaded fastener.

## Headlight

### Headlight beam throw and spring preload

Headlight beam throw is generally kept constant when spring preload is adjusted to suit load. Spring preload adjustment might not suffice only if the motorcycle is very heavily loaded. Under these circumstances, headlight beam throw has to be adjusted to suit the weight carried by the motorcycle.



### NOTICE

If there are doubts about the correct headlight beam throw, have the setting checked by a specialist workshop, preferably an authorised BMW Motorrad dealer. ◀

## Adjusting headlight beam throw

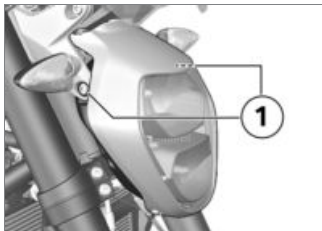

If, for a high load, the adjustment of the spring pre-load is no longer sufficient not to dazzle oncoming traffic:

- Slacken screws **1** with the tool from the on-board toolkit.

### NOTICE

Do not place the motorcycle on its centre stand or side stand.◀

- Pivot the headlight down slightly (depending on the load carried on the motorcycle) to

shorten the headlight beam throw.

When the motorcycle is again ridden with a lower load:

- Have the basic settings of the headlight restored by a specialist workshop, best of all by a BMW Motorrad dealer.
- Tighten screws **1** with the tool from the on-board toolkit.

## Clutch

### Adjusting the clutch lever

#### WARNING

#### Adjusting the clutch lever while riding

Risk of accident

- Do not attempt to adjust the clutch lever unless the motorcycle is at a standstill.◀

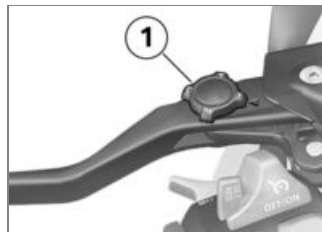

- Turn knob **1** to the desired position.

### NOTICE

The adjuster is easier to turn if you push the clutch lever forward.◀

- » Four settings are possible:
  - **Position 1:** smallest span between handlebar grip and clutch lever
  - **Position 4:** largest span between handlebar grip and clutch lever

## Brakes

### Adjusting the front brake lever

#### WARNING

#### Adjusting the brake lever while riding

Risk of accident

- Do not attempt to adjust the brake lever unless the motorcycle is at a standstill. ◀

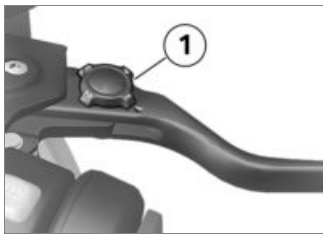

- Turn knob **1** to the desired position.



#### NOTICE

The adjuster is easier to turn if you push the brake lever forward. ◀

- » Four settings are possible:
- **Position 1:** smallest span between handlebar grip and brake lever
  - **Position 4:** largest span between handlebar grip and brake lever

### Spring preload

– without Dynamic ESA<sup>OE</sup>

#### Adjustment

It is essential to set spring preload of the rear suspension to suit the load carried by the motorcycle. Increase spring preload when the vehicle is heavily loaded and reduce spring preload accordingly when the vehicle is lightly loaded.

### Adjusting spring preload for rear wheel

- Make sure the ground is level and firm and place the motorcycle on its stand.

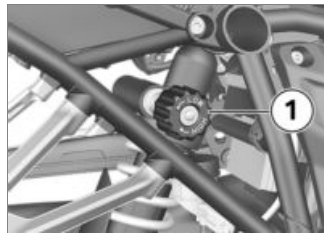

#### WARNING

#### Spring preload setting and spring-strut damping setting not matched.

Impaired handling.

- Adjust spring-strut damping to suit spring preload. ◀

## **WARNING**

### **Adjusting spring preload while riding.**

Risk of accident

- Do not attempt to adjust spring preload unless the motorcycle is at a standstill. ◀
- If you want to reduce spring preload, turn knob **1** in the direction indicated by the LOW arrow.
- If you want to increase spring preload, turn knob **1** in the direction indicated by the HIGH arrow.



Basic setting of spring preload, rear

Turn the adjuster knob as far as it will go in the LOW direction. (One-up without luggage)



Basic setting of spring preload, rear

Turn the adjuster knob as far as it will go in the LOW direction, then turn it 15 turns in the HIGH direction. (One-up with luggage)

Turn the knob as far as it will go in the HIGH direction. (Two-up with luggage)

## **Damping**

– Without Dynamic ESA<sup>OE</sup>

### **Adjustment**

Damping must be adapted to suit the surface on which the motorcycle is ridden and to suit spring preload.

- An uneven surface requires softer damping than a smooth surface.
- An increase in spring preload requires firmer damping, a re-

duction in spring preload requires softer damping.

### **Adjusting the damping characteristic for rear wheel**

- Make sure the ground is level and firm and place the motorcycle on its stand.
- Set the damping from the left-hand vehicle side.

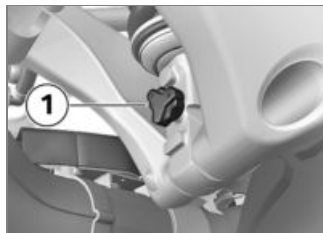

- Turn knob **1** clockwise to increase damping.
- Turn knob **1** counter-clockwise to reduce damping.



Basic setting of rear-suspension damping characteristic

Turn the knob clockwise as far as it will go, then back it off 6 clicks in the counter-clockwise direction. (One-up riding without luggage)

Turn the knob clockwise as far as it will go, then back it off 4 clicks in the counter-clockwise direction. (One-up with luggage)

Turn the knob clockwise as far as it will go. (Two-up with luggage)



## **Riding**

Safety instructions .....	88
Checklist.....	90
Starting .....	91
Running in .....	93
Shifting gear .....	94
Brakes .....	95
Parking your motorcycle .....	97
Refuelling .....	98
Securing motorcycle for transportation .....	102

## Safety instructions

### Rider's equipment

Do not ride without the correct clothing! Always wear:

- Helmet
- Motorcycling jacket and trousers
- Gloves
- Boots

This applies even to short journeys, and to every season of the year. Your authorised BMW Motorrad dealer will be glad to advise you on the correct clothing for every purpose.

### Loading



#### WARNING

### Handling adversely affected by overloading and imbalanced loads

Risk of falling

- Do not exceed the permissible gross weight and be sure to comply with the instructions on loading. ◀
- Adjust spring preload setting and damping to the total weight.
- Ensure that the case volumes on the left and right are equal.
- Make sure that the weight is uniformly distributed between right and left.
- Pack heavy items at the bottom and toward the inboard side.
- Note the maximum permissible payload and the speed limit for riding with cases fitted, as stated on the label inside the case (see also the section entitled "Accessories").
- with topcase <sup>OA</sup>
- Note the maximum permissible payload and the speed limit for riding with topcase fitted, as stated on the label inside

the case (see also the section entitled "Accessories"). ◀

- with tank rucksack, small <sup>OA</sup>
- Note the maximum permissible payload and the speed limit for riding with the small tank rucksack fitted.



Payload of the tank rucksack, small

max 5 kg



Speed limit for riding with tank rucksack, small, fitted to the vehicle

max 180 km/h ◀

### Speed

If you ride at high speed, always bear in mind that various boundary conditions can adversely affect the handling of your motorcycle:

- Spring-strut and shock-absorber system not set up correctly
- Imbalanced load
- Loose clothing
- Insufficient tyre pressure
- Poor tyre tread
- Etc.

## Top speed

### DANGER

#### **Maximum speed of the motorcycle is higher than the permissible maximum rated speed of the tyres**

Risk of accident due to tyre damage at high speed

- Comply with the tyre-specific speed restrictions.◀

Affix a label stating the maximum permissible speed in the rider's field of vision.

## Risk of poisoning

Exhaust fumes contain carbon monoxide, which is colourless and odourless but highly toxic.

### WARNING

#### **Exhaust gases adversely affecting health**

Risk of asphyxiation

- Do not inhale exhaust fumes.
- Do not run the engine in an enclosed space.◀

## Risk of burn injury

### CAUTION

#### **Engine and exhaust system become very hot when the vehicle is in use**

Risk of burn injury

- When you park the vehicle make sure that no-one and no objects can come into contact with the hot engine and exhaust system.◀

## Catalytic converter

If misfiring causes unburned fuel to enter the catalytic converter, there is a danger of overheating and damage.

The following guidelines must be observed:

- Do not run the fuel tank dry.
- Do not attempt to start or run the engine with a spark-plug cap disconnected.
- Stop the engine immediately if it misfires.
- Use only unleaded fuel.
- Comply with all specified maintenance intervals.

### ATTENTION

#### **Unburned fuel in catalytic converter**

Damage to catalytic converter

- Note the points listed for protection of the catalytic converter.◀

## Risk of overheating



### ATTENTION

#### Engine running for prolonged period with vehicle at standstill

Overheating due to insufficient cooling; in extreme cases vehicle fire

- Do not allow the engine to idle unnecessarily.
- Ride away immediately after starting the engine.◀

## Tampering



### ATTENTION

#### Tampering with the motorcycle (e.g. engine management ECU, throttle valves, clutch)

Damage to the affected parts, failure of safety-relevant functions, voiding of warranty

- Do not tamper with the vehicle in any way that could result in tuned performance.◀

## Checklist

### Comply with checklist

- At regular intervals, use the checklist below to check your motorcycle.

### Always before riding off:

- Check operation of the brake system.
- Check operation of the lights and signalling equipment.
- Checking clutch function (▣▣▣ 128).
- Checking tyre tread depth (▣▣▣ 130).
- Checking tyre pressure (▣▣▣ 129).
- Check that cases and luggage are securely held in place.

## Every 3rd refuelling stop

- Without Dynamic ESA<sup>OE</sup>
- Adjusting spring preload for rear wheel (▣▣▣ 84).
- Adjusting the damping characteristic for rear wheel (▣▣▣ 85).◀
- With Dynamic ESA<sup>OE</sup>
- Adjusting the chassis and suspension (▣▣▣ 72).◀
- Checking engine oil level (▣▣▣ 122).
- Checking front brake pad thickness (▣▣▣ 124).
- Check rear brake pad thickness (▣▣▣ 125).
- Checking brake-fluid level, front brakes (▣▣▣ 126).
- Checking the brake-fluid level, rear brakes (▣▣▣ 127).
- Check coolant level (▣▣▣ 128).

## Starting

### Start engine

- Switch on the ignition.
  - » Pre-Ride-Check is performed. (➡ 91)
  - » ABS self-diagnosis is in progress. (➡ 92)
  - » ASC/DTC self-diagnosis is in progress. (➡ 93)
- Select neutral or, if a gear is engaged, pull the clutch lever.



#### NOTICE

You cannot start the motorcycle with the side stand extended and a gear engaged. The engine will switch itself off if you start it with the gearbox in neutral and then engage a gear before retracting the side stand.◀

- For a cold engine start and low temperatures: pull clutch.



- Press starter button **1**.



#### NOTICE

The start attempt is automatically interrupted if battery voltage is too low. Recharge the battery before you start the engine, or use jump leads and a donor battery to start.

See the subsection on jump starting in "Maintenance" for more details.◀

- » The engine starts.
- » If the engine refuses to start, consult the troubleshooting

chart in the section entitled "Technical data". (➡ 178)

### Pre-Ride-Check

When the ignition is switched on, the instrument cluster runs a test of the instrument dials and the indicator and warning lights known as the "Pre-Ride-Check". The test is aborted if you start the engine before it completes.

#### Phase 1

The speedometer needle swings to the limit value on its scale. At the same time, all the indicator and warning lights are switched on in succession. The "General" warning light shows red.

#### Phase 2

The speedometer needle swings to the start position on its scale. At the same time, all the indicator and warning lights switched on in the initial phase are switched off in reverse sequence. The 'Gen-

eral' warning light changes from red to yellow.

The malfunction indicator lamp only goes out after 15 seconds.

If the needle of the speedometer did not move or if an indicator or warning light was not switched on:



## WARNING

### Faulty warning lights

No indication of malfunctions

- Check all the telltale and warning lights. ◀
- Have the fault rectified as quickly as possible by a specialist workshop, preferably an authorised BMW Motorrad dealer.

### ABS self-diagnosis

BMW Motorrad Integral ABS performs self-diagnosis to ensure its operability. Self-diagnosis is performed automatically when you switch on the ignition.

#### Phase 1

- » Test of the diagnosable system components with the vehicle at a standstill.



flashes.

#### Phase 2

- » Test of the wheel-speed sensors as the vehicle pulls away from rest.



flashes.

### ABS self-diagnosis completed

- » The ABS telltale and warning light goes out.

- Check all the indicator and warning lights.



ABS self-diagnosis not completed

The ABS function is not available, because self-diagnosis did not complete. (The motorcycle has to reach a defined minimum speed for the wheel speed sensors to be checked: 5 km/h)

If an indicator showing an ABS fault appears when ABS self-diagnosis completes:

- You can continue to ride. Bear in mind that neither the ABS function nor the integral braking function is available.
- Have the fault rectified as quickly as possible by a specialist workshop, preferably an authorised BMW Motorrad dealer.

## ASC/DTC self-diagnosis

The BMW Motorrad ASC/DTC performs self-diagnosis to ensure its operability. Self-diagnosis is performed automatically when you switch on the ignition.

### Phase 1

- » Test of the diagnosable system components with the vehicle at a standstill.



slow-flashes.

### Phase 2

- » Test of the diagnosis-compatible system components while the motorcycle is on the move.



slow-flashes.

## ASC/DTC self-diagnosis completed

- » The ASC/DTC indicator and warning light goes out.

- Check all the indicator and warning lights.



ASC/DTC self-diagnosis not completed

The ASC/DTC function is not available, because self-diagnosis did not complete. (The motorcycle has to reach a defined minimum speed for the wheel speed sensors to be checked: 5 km/h)

If an indicator showing an ASC/DTC fault appears when ASC/DTC self-diagnosis completes:

- You can continue to ride. Bear in mind that the ASC/DTC function is not available.
- Have the fault rectified as quickly as possible by a specialist workshop, preferably an authorised BMW Motorrad dealer.

## Running in Engine

- Until the first running-in check, vary the throttle opening and engine-speed range frequently; avoid riding at constant engine rpm for prolonged periods.
- Try to do most of your riding during this initial period on twisting, fairly hilly roads.
- Comply with the rpm limits for running in.



Running-in speeds

<5000 min<sup>-1</sup> (Odometer reading 0...1000 km)

No full throttle (Odometer reading 0...1000 km)

- Note the mileage after which the running-in check should be carried out.



Mileage until the running-in check

500...1200 km

## Brake pads

New brake pads have to bed down before they can achieve their optimum friction levels. You can compensate for this initial reduction in braking efficiency by exerting greater pressure on the levers.



### WARNING

#### New brake pads

Longer stopping distance, risk of accident

- Apply the brakes in good time.◀

## Tyres

New tyres have a smooth surface. This must be roughened by riding in a restrained manner at various heel angles until the tyres are run in. This running in procedure is essential if the tyres are to achieve maximum grip.



### WARNING

#### New tyres losing grip on wet roads and at extreme bank angles

Risk of accident

- Ride carefully and avoid extremely sharp inclines.◀

## Shifting gear

– with Pro shift assistant<sup>OE</sup>

### Shift assistant Pro



### NOTICE

The Pro shift assistant assists upshifts and downshifts without

the rider having to disengage the clutch or close the throttle. This is not an automatic-shift system. The rider is the most important part of the system and decides when to shift gears.

See the section entitled "Engineering details" for more information on the Pro shift assistant.◀



### NOTICE

Whenever the Pro shift assistant shifts gears, cruise control is automatically disengaged for safety reasons.◀



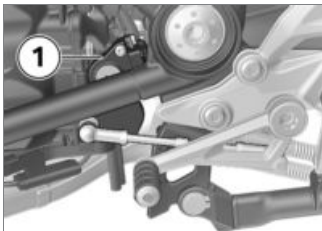

- You select the gear in the usual way by means of the foot-operated shift lever.
- » Sensor **1** on the selector shaft registers the shift request and triggers shift assistance.
- » When riding at a steady speed in a low gear at high engine rpm, an attempt to shift gear without pulling the clutch can cause a severe load-change reaction. BMW Motorrad recommends disengaging the clutch for shifts in these circumstances. It is advisable to avoid using the Pro shift assistant at engine speeds close to

the limits at which the governor cuts in to limit engine rpm.

- » Shift assistance is not available in the following situations:
  - With clutch lever pulled.
  - Shift lever not in its initial position.
  - Upshifts with a closed throttle valve (coasting overrun) and when braking.
- After a gear change, the shift lever has to be fully released before another gear change with the Pro shift assistant can take place.

## Brakes

### How can stopping distance be minimised?

Each time the brakes are applied, a load distribution shift takes place with the load shifting forward from the rear to the front wheel. The sharper the vehicle decelerates, the more load is

shifted to the front wheel. The higher the wheel load, the more braking force can be transmitted without the wheel locking.

To optimise stopping distance, apply the front brakes rapidly and keep on increasing the force you apply to the brake lever. This makes the best possible use of the dynamic increase in load at the front wheel. Remember to pull the clutch at the same time. In the extreme sudden-stop braking situations that are trained so frequently, braking force is applied as rapidly as possible and with the rider's full force applied to the brake levers; under these circumstances the dynamic shift in load distribution cannot keep pace with the increase in deceleration and the tyres cannot transmit the full braking force to the surface of the road.

BMW Motorrad Integral ABS prevents the front wheel from locking up.

## Hazard braking

– with ABS Pro<sup>OE</sup>

If you brake sharply from a speed in excess of 50 km/h, the brake light flashes rapidly as an additional warning for road users behind you.

The hazard warning lights system switches on if you brake to below 15 km/h in this process. The hazard warning lights system automatically switches off from a speed of 20 km/h.

## Descending mountain passes



### WARNING

**Braking only with the rear brake on mountain descents**

Brake fade, destruction of the brakes due to overheating

- Use both front and rear brakes, and make use of the engine's braking effect as well. ◀

## Wet and dirty brakes

Wetness and dirt on the brake discs and the brake pads diminish braking efficiency.

Delayed braking action or poor braking efficiency must be reckoned with in the following situations:

- Riding in the rain or through puddles of water.
- After the vehicle has been washed.
- Riding on salted or gritted roads.
- After work has been carried on the brakes, due to traces of oil or grease.
- Riding on dirty surfaces.



### WARNING

## Wetness and dirt result in diminished braking efficiency

Risk of accident

- Apply the brakes lightly while riding to remove wetness and dirt, or dismount and clean the brakes.
- Think ahead and brake in good time until full braking efficiency is restored. ◀

## ABS Pro

– with ABS Pro<sup>OE</sup>

## Physical limits applicable to motorcycling

### WARNING

#### Braking when cornering

Risk of crash despite ABS Pro

- Invariably, it remains the rider's responsibility to adapt riding style to riding conditions.
- Do not take risks that would negate the additional safety offered by this system.◀

ABS Pro is available in all riding modes.

#### Possibility of a fall not precluded

Although ABS Pro provides the rider with valuable assistance and constitutes a huge advance in safety for braking with the motorcycle banked for cornering, it cannot under any circumstances be considered as redefining the physical limits that apply to mo-

torcycling. It is still possible for these limits to be overshoot due to misjudgement or rider error. In extreme cases this can result in a crash.

#### Use on public roads

ABS Pro helps make the motorcycle even safer for riding on public roads. When the brakes are applied because of an unforeseen hazard when the motorcycle is banked for cornering, within the physical limits that apply to motorcycling the system prevents the wheels from locking and skidding away.

### NOTICE

ABS Pro was not developed to enhance individual braking performance with the motorcycle banked into corners in situations approaching the limits of performance.◀

## Parking your motorcycle

### Side stand

- Switch off the engine.

### ATTENTION

#### Poor ground underneath the stand

Risk of damage to parts if vehicle topples

- Always check that the ground under the stand is level and firm.◀

### ATTENTION

#### Additional weight placing strain on the side stand

Risk of damage to parts if vehicle topples

- Do not sit or lean on the vehicle while it is propped on the side stand.◀

- Extend the side stand and prop the motorcycle on the stand.
- Turn the handlebars all the way to left.
- On a gradient, the motorcycle should always face uphill; select 1st gear.

## Centre stand

– with centre stand<sup>OE</sup>

- Switch off the engine.



### ATTENTION

## Poor ground underneath the stand

Risk of damage to parts if vehicle topples

- Always check that the ground under the stand is level and firm. ◀



### ATTENTION

## Centre stand folds in due to sharp movements

Risk of damage to parts if vehicle topples

- Do not lean or sit on the vehicle with the centre stand extended. ◀
- Extend the centre stand and lift the motorcycle onto the stand.
- On a gradient, the motorcycle should always face uphill; select 1st gear.

## Refuelling

### Fuel grade

### Requirement

For optimum fuel consumption, fuel should be sulphur-free or with the lowest sulphur content possible.



### ATTENTION

## Engine operation with leaded fuel

Damage to catalytic converter

- Do not attempt to run the vehicle on leaded fuel or fuel with metallic additives (e.g. manganese or iron). ◀
- You can run the engine on fuel with a maximum ethanol content of 10%, i.e. E10.



Recommended fuel grade

Super unleaded (max. 10 % ethanol, E10)  
95 ROZ/RON  
89 AKI

## Refuelling



### WARNING

## Fuel is highly flammable

Risk of fire and explosion

- Do not smoke. Never bring a naked flame near the fuel tank. ◀

## WARNING

### Escape of fuel due to heat-induced expansion if fuel tank is overfilled

Risk of falling

- Do not overfill the fuel tank.◀

## ATTENTION

### Wetting of plastic surfaces by fuel

Damage to the surfaces (surfaces become unsightly or dull)

- Clean plastic surfaces immediately after contact with fuel.◀
- Make sure the ground is level and firm and place the motorcycle on its side stand.

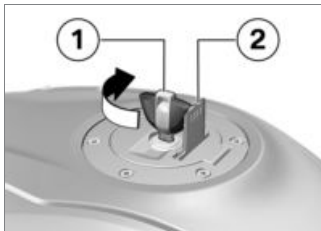

- Open the protective cap **2**.
- Use ignition key **1** to unlock fuel filler cap by turning it clockwise, and flip the cap open.



- Refuel with fuel of the grade stated above; do not fill the

tank past the bottom edge of the filler neck.

## NOTICE

When refuelling after running on reserve, make sure that you top up the tank to a level above reserve, as otherwise the new level will not be registered and the fuel warning light indicating that the level is down to reserve will not be switched off.◀

## NOTICE

The "usable fuel capacity" specified in the technical data is the quantity that the fuel tank could hold if refilled after it had been run dry and the engine had cut out due to a lack of fuel.◀



Usable fuel capacity

approx. 18 l



Reserve fuel

approx. 4 l

- Press the fuel tank cap down firmly to close.
- Remove the ignition key and close the protective cap.

## Refuelling

– with Keyless Ride<sup>OE</sup>

### Requirement

The steering lock is disengaged.



## WARNING

### Fuel is highly flammable

Risk of fire and explosion

- Do not smoke. Never bring a naked flame near the fuel tank. ◀



## WARNING

### Escape of fuel due to heat-induced expansion if fuel tank is overfilled

Risk of falling

- Do not overfill the fuel tank. ◀



## ATTENTION

### Wetting of plastic surfaces by fuel

Damage to the surfaces (surfaces become unsightly or dull)

- Clean plastic surfaces immediately after contact with fuel. ◀
- Make sure the ground is level and firm and place the motorcycle on its side stand.
- Switching off ignition (▶▶▶ 49).



## NOTICE

The fuel filler cap can be opened within the defined waiting time after the ignition has been

switched off, without the radio-operated key being within range. ◀



Waiting time for opening fuel filler cap

2 min

- » There are **two variant ways** of opening the fuel filler cap:
- Within the after-running period.
  - After the after-running period has expired.

### Version 1

– with Keyless Ride<sup>OE</sup>

### Requirement

Within the waiting time:

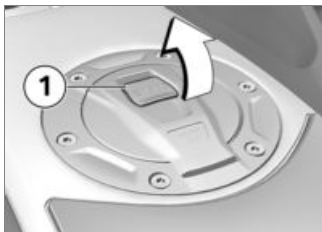

- Pull up tab **1** of the fuel filler cap slowly.
- » Fuel filler cap unlocks.
- Fully open the fuel filler cap.

## Version 2

– with Keyless Ride<sup>OE</sup>

### Requirement

After the waiting time has expired:

- Bring the radio-operated key into range.
- Slowly pull tab **1** up.
- » The telltale light for the radio-operated key flashes while the

search for the radio-operated key is in progress.

- Again slowly pull up tab **1** of the fuel filler cap.
- » Fuel filler cap unlocks.
- Fully open the fuel filler cap.



- Refuel with fuel of the grade stated above; do not fill the tank past the bottom edge of the filler neck.

### NOTICE

When refuelling after running on reserve, make sure that you top up the tank to a level above reserve, as otherwise the new level

will not be registered and the fuel warning light indicating that the level is down to reserve will not be switched off. ◀

### NOTICE

The "usable fuel capacity" specified in the technical data is the quantity that the fuel tank could hold if refilled after it had been run dry and the engine had cut out due to a lack of fuel. ◀

 Usable fuel capacity

approx. 18 l

 Reserve fuel

approx. 4 l

- Press down firmly on the filler cap of the fuel tank.
- » The fuel filler cap engages with an audible click.

- » The fuel filler cap locks automatically when the waiting time expires.
- » The engaged fuel filler cap locks immediately when you secure the steering lock or switch on the ignition.

## Securing motorcycle for transportation

- Make sure that all components that might come into contact with straps used to secure the motorcycle are adequately protected against scratching. Use adhesive tape or soft cloths, for example, for this purpose.



### ATTENTION

#### Vehicle topples to side when being lifted on to stand

Risk of damage to parts if vehicle topples

- Secure the vehicle to prevent it toppling, preferably with the assistance of a second person.◀
- Push the motorcycle onto the transportation flat and hold it in position: do not place it on the side stand or centre stand.

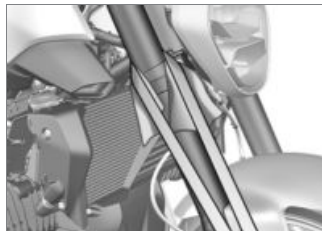

### ATTENTION

#### Trapping of components

Component damage

- Do not trap components such as brake lines or cable legs.◀
- At the front, loop a strap over the bottom fork bridge on each side.
- Pull the straps down and tight.



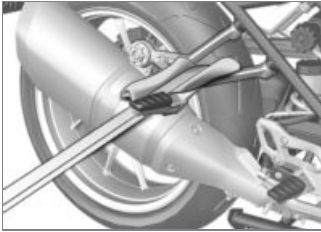

- Secure the tensioning straps at the rear on both sides to the frame for the rear footrest and tighten the straps.
- Tighten all the straps uniformly; the vehicle's suspension should be compressed as tightly as possible front and rear.



## Engineering details

General instructions.....	106
Anti-lock brake system (ABS) .....	106
Automatic Stability Control (ASC) .....	109
Dynamic Traction Control (DTC) .....	110
Electronic Suspension Adjustment (ESA) .....	112
Riding mode .....	113
Tyre pressure monitoring (RDC) .....	114
Shift assistant Pro .....	116

## General instructions

To find out more about engineering go to:

**[bmw-motorrad.com/technology](http://bmw-motorrad.com/technology)**

## Anti-lock brake system (ABS)

### Partially integral brakes

Your motorcycle is equipped with partially integral brakes. Both front and rear brakes are applied when you pull the handbrake lever. The footbrake lever acts only on the rear brake.

When actively intervening in the braking process, the BMW Motorrad Integral ABS adapts braking-force distribution between front and rear brakes to suit the load on the motorcycle, and so ABS intervention helps achieve the shortest possible stopping distance.



## ATTENTION

### Attempted burn-out despite Integral braking function

Damage to rear brake and clutch

- Do not burn out tyres.◀

### How does ABS work?

The amount of braking force that can be transferred to the road depends on factors that include the coefficient of friction of the road surface. Loose stones, ice and snow or a wet road all have much lower coefficients of friction than a clean and dry asphalt surface. The lower the coefficient of friction, the longer the braking distance.

If the rider increases braking pressure to the extent that braking force exceeds the maximum transferable limit, the wheels start to lock and the vehicle loses its directional stability; a fall is imminent. Before this situation

can occur, ABS intervenes and adapts braking pressure to the maximum transferable braking force. The wheels continue to turn and the driving stability is retained irrespective of the road condition.

### What are the effects of surface irregularities?

Humps and surface irregularities can cause the wheels to lose contact temporarily with the road surface; if this happens the braking force that can be transmitted to the road can drop to zero. If the brakes are applied under these circumstances the ABS has to reduce braking force to ensure that directional stability is maintained when the wheels regain contact with the road surface. At this instant the ABS must assume an extremely low coefficient of friction, so that the wheels will continue to rotate un-

der all imaginable circumstances, because this is the precondition for ensuring directional stability. As soon as it registers the actual circumstances, the system reacts instantly and adjusts braking force accordingly to achieve optimum braking.

### **What feedback does the rider receive from the ABS?**

If the ABS has to reduce braking force on account of the circumstances described above, vibration is perceptible through the handbrake lever.

When the handbrake lever is pulled, brake pressure is also built up at the rear wheel by the integral function. If the brake pedal is depressed after the handbrake lever is pulled, the brake pressure built up beforehand is perceptible as counter-pressure sooner than is

the case when the brake pedal is depressed either before or at the same time as the brake lever is pulled.

### **Rear wheel lift**

Under very severe and sudden deceleration, however, under certain circumstances it is possible that the ABS will be unable to prevent the rear wheel from lifting clear of the ground. If this happens the outcome can be a highside situation in which the motorcycle can flip over.



### **Rear wheel lift due to severe braking**

Risk of falling

- When you brake sharply, bear in mind that ABS control cannot always be relied on to prevent the rear wheel from lifting clear of the ground. ◀

## **What is the design baseline for ABS?**

Within the limits imposed by physics, the ABS ensures directional stability on any surface. The system is not optimised for special requirements that apply under extreme competitive situations on the track. The driving behaviour should be adapted to actual driving skills and the road conditions.

### **Special situations**

The speeds of the front and rear wheels are compared as one means of detecting a wheel's incipient tendency to lock. If the system registers implausible values for a lengthy period the ABS function is deactivated for safety reasons and an ABS fault message is issued. Self-diagnosis has to complete before fault messages can be issued.

In addition to problems with the BMW Motorrad ABS, exceptional riding conditions can also cause a fault message to be issued:

- Heating up with the motorcycle on the centre stand or an auxiliary stand, engine idling or with a gear engaged.
- Rear wheel locked by the engine brake for a lengthy period, for example while descending on a loose or slippery surface.

If a fault message is issued on account of exceptional riding conditions, you can reactivate the ABS function by switching the ignition off and on again.

### What significance devolves on regular maintenance?



#### WARNING

**Brake system not regularly serviced.**

Risk of accident

- In order to ensure that the ABS is always maintained in optimum condition, it is essential for you to comply strictly with the specified inspection intervals. ◀

### Reserves for safety

The potentially shorter braking distances which ABS permits must not be used as an excuse for careless riding. ABS is primarily a means of ensuring a safety margin in genuine emergencies.



#### WARNING

### Braking when cornering

Risk of accident despite ABS

- Invariably, the rider bears responsibility for assessing road and traffic conditions and adopting his or her style of riding accordingly.

- Do not take risks that would negate the additional margin of safety offered by this system. ◀

### Evolution of ABS to ABS Pro

– with ABS Pro<sup>OE</sup>

Until now, the BMW Motorrad ABS helped ensure a very high degree of safety for braking with the motorcycle upright and travelling in a straight line. Now ABS Pro offers enhanced safety for braking in corners as well. ABS Pro prevents the wheels from locking even under sharp braking. ABS Pro reduces abrupt changes in steering force, particularly in panic-braking situations, counteracting the vehicle's otherwise natural but undesirable tendency to straighten up.

## ABS intervention

Technically speaking, depending on the riding situation ABS Pro adapts ABS intervention to the motorcycle's bank angle. Signals for rate of roll and rate of yaw and lateral acceleration are used to calculate bank angle.

As the motorcycle is heeled over more and more as it banks into a corner, an increasingly strict limit is imposed on the brake-pressure gradient for the start of brake application. This slows the build-up of brake pressure to a corresponding degree. Additionally, pressure modulation is more uniform across the range of ABS intervention.

## Advantages for the rider

The advantages of ABS Pro for the rider are sensitive response and high braking and directional stability combined with best-case

deceleration of the motorcycle, even when cornering.

## Automatic Stability Control (ASC)

### How does the ASC work?

The ASC system compares the speed of rotation of the front wheel and the rear wheel. The differential is used to compute slip as a measure of the reserves of stability available at the rear wheel. If slip exceeds a certain limit, the engine control intervenes and adapts the engine torque accordingly.

### What is the design baseline for the ASC?

ASC is designed as an assistance system for the rider and for use on public roads. The extent to which the rider affects ASC control can be considerable (weight shifts when corner-

ing, items of luggage loose on the motorcycle), especially when style of riding takes rider and machine close to the limits imposed by physics.

The system is not optimised for special requirements that apply under extreme competitive situations on the track. The ASC can be deactivated in these cases.

### WARNING

#### Risky riding

Risk of accident despite ASC

- Invariably, the rider bears responsibility for assessing road and traffic conditions and adapting his or her style of riding accordingly.
- Do not take risks that would negate the additional safety offered by this system. ◀

## Special situations

In accordance with the laws of physics, the ability to accelerate is restricted more and more as the angle of heel increases. Consequently, there can be a perceptible lag in acceleration out of very tight bends.

The speeds of the front and rear wheels are compared as one means of detecting the rear wheel's incipient tendency to spin or slip sideways. If the system registers implausible values for a lengthy period the ASC function is deactivated for safety reasons and an ASC fault message is issued. Self-diagnosis has to complete before fault messages can be issued.

The following exceptional riding conditions can lead to an automatic shutdown of the ASC:

- Riding for a lengthy period with the front wheel lifted off the ground (wheelie).
- Rear wheel rotating with the vehicle held stationary by applying the front brake (burn-out).
- Heating up with the motorcycle on the centre stand or an auxiliary stand, engine idling or with a gear engaged.

Accelerating the motorcycle to a defined minimum speed after switching the ignition off and then on again reactivates the ASC.



Minimum speed for activation of ASC

min 10 km/h

If the front wheel lifts clear of the ground under severe acceleration, the ASC reduces engine

torque until the front wheel regains contact with the ground. Under these circumstances, BMW Motorrad recommends rolling the throttle slightly closed so as to restore stability with the least possible delay.

When riding on a slippery surface, never snap the throttle twistgrip fully closed without pulling the clutch at the same time. Engine braking torque can cause the rear wheel to lock, with a corresponding loss of stability. The ASC is unable to control a situation of this nature.

## Dynamic Traction Control (DTC)

- with Dynamic Traction Control (DTC)<sup>OE</sup>



## How does the DTC work?

The DTC system compares the speed of rotation of the front wheel and the rear wheel. The differential is used to compute slip as a measure of the reserves of stability available at the rear wheel. If slip exceeds a certain limit, the engine control intervenes and adapts the engine torque accordingly.

The DTC has a bank-angle sensor, so it can control wheel slip all the more sensitively when the motorcycle is heeled over for cornering. Consequently, more dynamic riding conditions can be achieved without any lessening of directional stability. In the DYNAMIC mode slight DTC-assisted wheelies are possible.

## What is the design baseline for the DTC?

DTC is designed as an assistance system for the rider and for use on public roads. The extent to which the rider affects DTC control can be considerable (weight shifts when cornering, items of luggage loose on the motorcycle), especially when style of riding takes rider and machine close to the limits imposed by physics.

The system is not optimised for special requirements that apply under extreme competitive situations on the track. You have the option of deactivating the DTC for these circumstances.

### **WARNING**

#### **Risky riding**

Risk of accident despite DTC

- Invariably, the rider bears responsibility for assessing road

and traffic conditions and adapting his or her style of riding accordingly.

- Do not take risks that would negate the additional safety offered by this system.◀

## Special situations

In accordance with the laws of physics, the ability to accelerate is restricted more and more as the angle of heel increases. Consequently, there can be a perceptible reduction in acceleration out of very tight bends.

The speeds of the front and rear wheels are compared and the angle of heel taken into account as one means of detecting the rear wheel's incipient tendency to spin or slip sideways. If the electronic processor receives values that it considers implausible over a lengthy period, a dummy value is used for the angle of heel or

the DTC function is switched off. Under these circumstances the indicator for a DTC fault shows. Self-diagnosis has to complete before fault messages can be issued.

Whereas in the RAIN and ROAD riding modes, if the front wheel starts to lift clear of the ground the DTC reduces engine torque and the front wheel quickly regains contact with the ground, in the DYNAMIC mode slight DTC-assisted wheelies are possible.

The DTC can issue an error message under the exceptional riding conditions outlined below.

### Exceptional riding conditions:

- Riding for a lengthy period with the front wheel lifted off the ground (wheelie).
- Rear wheel rotating with the vehicle held stationary by applying the front brake (burn-out).

- Heating up with the motorcycle on an auxiliary stand, in neutral or with a gear engaged.

Accelerating the motorcycle to a defined minimum speed after switching the ignition off and then on again reactivates the DTC.



Minimum speed for activation of DTC

min 10 km/h

If the front wheel lifts clear of the ground under severe acceleration, the DTC reduces engine torque until the front wheel regains contact with the ground. Under these circumstances, BMW Motorrad recommends rolling the throttle slightly closed so as to restore stability with the least possible delay.

When riding on a slippery surface, never snap the throttle twistgrip fully closed without pulling the clutch at the same time. Engine braking torque can cause the rear wheel to skid, with a corresponding loss of stability. The DTC is unable to control a situation of this nature.

## Electronic Suspension Adjustment (ESA)

- With Dynamic ESA<sup>OE</sup>

### Dynamic ESA Possible settings

Dynamic ESA enables you to adjust your motorcycle's suspension to suit the load and the road conditions.

By interpreting ride height sensor signals, Dynamic ESA detects movements in the chassis and suspension and responds by adjusting the damper valves. The

chassis and suspension will thus be adapted to the characteristics of the terrain.

You can set the damping to a harder (DYNAMIC) setting than the basic setting (ROAD).

Dynamic ESA calibrates itself at regular intervals when stationary with the engine running to ensure the correct operating principle of the system. During this calibration, chassis and suspension adjustment is not possible.

## Riding mode

### Selection

There is a choice of 4 riding modes for adapting the motorcycle to riding-surface condition:

RAIN

ROAD (standard mode)

– with Pro riding modes<sup>OE</sup>  
DYNAMIC  
USER

Each of these modes produces perceptible differences in the way the motorcycle behaves. For the RAIN, ROAD and DYNAMIC riding modes there is a matched setting for the ASC/DTC and ENGINE (throttle response) systems. The mode last selected is automatically reactivated after the ignition has been switched off and then on again.

Broadly speaking: The more dynamic the selected mode, the more ASC/DTC assistance is reduced. Consequently, you must always bear the following in mind with regard to your selection of a ride mode: the more dynamic the setting, the greater the challenge to your riding skill.

### Throttle response

- In the RAIN mode: Restrained
- In the ROAD mode: Direct
- In the DYNAMIC mode: Dynamic

### RAIN mode

The ASC/DTC system intervenes early enough to prevent the rear wheel from spinning. On road surfaces with high to medium grip (dry and wet asphalt to dry cobblestones) the motorcycle remains very stable; movements of the tail are clearly perceptible only on slippery road surfaces (wet bitumen or wet cobblestones).

### ROAD mode

ASC/DTC system intervention is later than in RAIN mode. On road surfaces with high to medium grip (dry and wet asphalt to dry cobblestones) the motorcycle remains stable. Slight rear-wheel

drift is perceptible. Movements of the tail are clearly perceptible on slippery road surfaces (wet bitumen or wet cobblestones).

– with Pro riding modes<sup>OE</sup>

### **DYNAMIC mode**

The DYNAMIC mode is the sportiest mode. ASC/DTC system intervention is even later, which means that even on dry asphalt drifting is possible under sharp acceleration when cornering.

### **USER mode**

The USER mode enables the DTC and ENGINE system settings to be individualised.

- ENGINE: Choice of RAIN, ROAD and DYNAMIC settings  
- DTC: Choice of RAIN, ROAD and DYNAMIC settings

The changed USER are saved in memory until the next time changes are made.

### **Mode changes**

When riding, you can change riding modes only when the following preconditions are satisfied:

- No drive torque on the rear wheel.
- No brake pressure in the brake system.

This is the status of the motorcycle when it is at a standstill with the ignition switched on. Under other circumstances, you must proceed as follows:

- Close the throttle twistgrip.
- Release the brake levers.

The desired riding mode is initially preselected. The mode change does not take place until the systems in question are all in the appropriate state.

### **Tyre pressure monitoring (RDC)**

– with tyre pressure monitoring (RDC)<sup>OE</sup>

#### **Function**

A sensor integrated into each tyre measures the air temperature and the air pressure inside the tyre and transmits this information to the control unit. Each sensor has a centrifugal-force tripswitch that does not enable transmission of the measured values until the motorcycle has exceeded a defined minimum speed for the first time.



Minimum speed for transmission of the RDC measured values:

min 30 km/h

The display shows -- for each tyre until the tyre-pressure signal is received for the first time. The

sensors continue to transmit the measured-value signals for some time after the vehicle comes to a stop.



Time for transmission of measured values after vehicle comes to a stop:

min 15 min

An error message is issued if wheels without sensors are fitted to a vehicle equipped with an RDC control unit.

## Tyre-pressure ranges

The RDC control unit differentiates between three tyre-pressure ranges, all of which are parameterised for the motorcycle:

- Tyre pressure within permitted tolerance.
- Tyre pressure close to limit of permitted tolerance.
- Tyre pressure outside permitted tolerance.

## Temperature compensation

Tyre pressure is a temperature-sensitive variable: pressure increases as tyre temperature rises and decreases as tyre temperature drops. Tyre temperature depends on ambient temperature as well as on the style of riding and the duration of the ride.



The tyre-pressure readings in the multifunction display are temperature-compensated and are always referenced to the following tyre-air temperature:

20 °C

The air lines available to the public in petrol stations and motorway service areas have gauges that do not compensate for temperature; the reading shown by a gauge of this nature is the temperature-dependent tyre pressure. In most instances,

therefore, these gauge readings will not tally with the pressures shown by the multifunction display.

## Pressure adaptation

Compare the RDC value on the multifunction display with the value in the table on the back cover of the Rider's Manual. Then use the air line at a service station to compensate for the difference between the RDC reading and the value in the table.



Example

According to the Rider's Manual, the tyre pressure should be:

2.5 bar

The multifunction display shows the following reading:

 Example
2.3 bar
So pressure is low by:
0.2 bar
The gauge on the air line shows:
2.4 bar
You must now increase tyre pressure until the value is:
2.6 bar

## Shift assistant Pro

- with Pro shift assistant<sup>OE</sup>

Your vehicle is equipped with the shift assistant Pro, which was initially developed for racing and has been adapted for touring. It permits upshifts and downshifts without declutching or closing the throttle in virtually all load and rpm ranges.

## Advantages

- 70-80 % of all gearshifts on a trip can be done without using the clutch.
- Less relative movement between rider and passenger because the shift pauses are shorter.
- It is not necessary to close the throttle valve when shifting under acceleration.
- When braking and downshifting (throttle valve closed), engine speed is adjusted by blipping the throttle.
- Shift time is shorter than a gearshift with clutch actuation.

In order for the system to identify a request for a gearshift, the rider has to move the shift lever from its idle position in the desired direction against the force of the spring through a certain "over-travel" at ordinary speed or rap-

idly and keep the shift lever in this position until the gearshift is completed. It is not necessary to increase the force applied to the shift lever while shifting is in progress. Once the gearshift has completed the shift lever has to be fully released before another gearshift with the Pro shift assistant can take place. Keep the corresponding load condition (throttle grip position) constant before and during the gear shift for gear shifts using the shift assistant Pro. A change in the position of the throttle twistgrip during a gearshift can cause the function to abort and/or lead to a missed shift. The shift assistant Pro provides no assistance for the gear change if the rider declutches.

## Downshifting

- Downshifting is assisted until maximum rpm for the target gear to be selected is reached. This prevents overrevving.

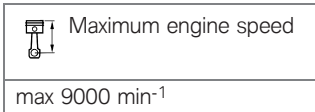

## Upshifting

- Upshifting is assisted until idle rpm for the target gear to be selected is reached.
- This prevents the engine from dropping below idle speed.

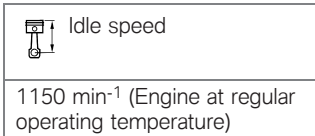





## Maintenance

General instructions.....	120
Toolkit .....	120
Front-wheel stand .....	120
Rear-wheel stand .....	122
Engine oil .....	122
Brake system .....	124
Clutch .....	128
Coolant .....	128
Tyres .....	129
Rims and tyres.....	130
Wheels .....	130
Silencer.....	138
Light source .....	139
Jump-starting.....	151
Battery.....	152

Fuses .....	156
Diagnostic connector .....	157

## General instructions

The "Maintenance" chapter describes straightforward procedures for checking and replacing certain wear parts.

Special tightening torques are listed as applicable. The tightening torques for the threaded fasteners on your vehicle are listed in the section entitled "Technical data".

Further information on maintenance and repair work is available from your BMW Motorrad authorised dealer in the form of a DVD.

Some of the work requires special tools and a thorough knowledge of the technology involved. If you are in doubt, consult a specialist workshop, preferably your authorised BMW Motorrad dealer.

## Toolkit

### Standard toolkit

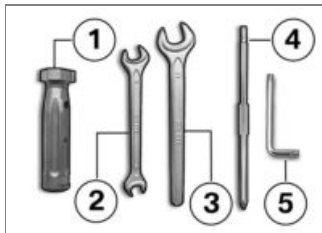

- 1** Screwdriver handle
  - Use with screwdriver insert.
  - Topping up the engine oil (➡ 123).
- 2** Open-ended spanner  
Width across flats 8/10
  - Removing battery (➡ 154).
- 3** Open-ended spanner  
Width across flats 14
  - Adjusting mirror arm (➡ 82).

- 4** Reversible screwdriver blade  
Phillips PH1 and Torx T25
  - Removing bulbs for front and rear turn indicators (➡ 147).
  - Removing battery cover (➡ 154).
- 5** Torx wrench, T40
  - Adjusting headlight beam throw (➡ 83).

## Front-wheel stand

### Installing the front-wheel stand



#### ATTENTION

### Use of the BMW Motorrad front wheel stand without accompanying use of centre stand or auxiliary stand

Risk of damage to parts if vehicle topples

- Place the motorcycle on its centre stand or another auxilli-

ary stand before lifting the front wheel with the BMW Motorrad front-wheel stand.◀

- Make sure the ground is level and firm and place the motorcycle on its centre stand.
- Use basic stand with front-wheel adapter. The basic stand and its accessory parts are available from your BMW Motorrad dealer.

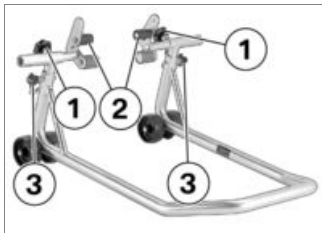

- Loosen the fastening screws **1**.
- Push the two adapters **2** apart until the front forks fit between them.

- Use locating pins **3** to set the front-wheel stand to the desired height.
- Centre the front-wheel stand relative to the front wheel and push it against the front axle.

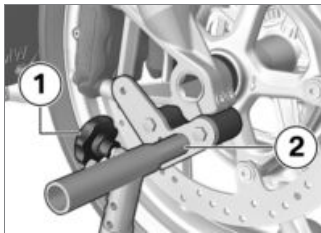

- Align the two adapters **2** so that the front forks are securely seated.
- Tighten securing screws **1**.



### ATTENTION

#### Centre stand retracts if motorcycle is lifted too high

Risk of damage to parts if vehicle topples

- When raising the vehicle, make sure that the centre stand remains on the ground.◀
- Apply uniform pressure to push the front-wheel stand down and raise the motorcycle.

## Rear-wheel stand

### Install the rear-wheel stand

- Make sure the ground is level and firm and place the motorcycle on its stand.
- Use basic stand with rear axle adapter. The basic stand and its accessory components are available from your BMW Motorrad authorised dealer.

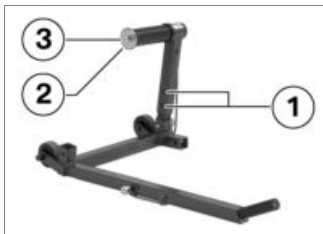

- Use screws **1** to set the rear-wheel stand to the desired height.

- Remove retaining disc **2**. To do so, press release button **3**.

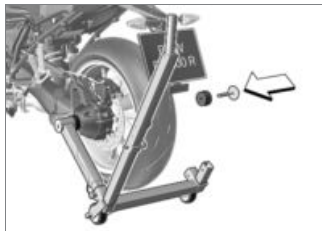

- Push the rear-wheel stand from the right onto the rear axle.
- Push the retaining disc on from the left, while holding the unlock button down.



- Hold the motorcycle upright and at the same time press the handle of the stand back until both rollers of the stand are on the ground.
- Then press the handle down to the ground.

## Engine oil

### Checking engine oil level



#### ATTENTION

**Misinterpretation of oil level reading, because oil level is temperature-dependent (the**

## higher the temperature, the higher the oil level)

### Engine damage

- Check the oil level only after a lengthy ride or when the engine is at operating temperature.◀
- Switch off the engine when it is at operating temperature.
- Extend the side stand and take up a position on the right side of the motorcycle.
- Hold the motorcycle upright. – with centre stand<sup>OE</sup>
- Make sure the ground is level and firm and place the motorcycle on its centre stand.<
- Wait five minutes for the oil to drain into the oil pan.

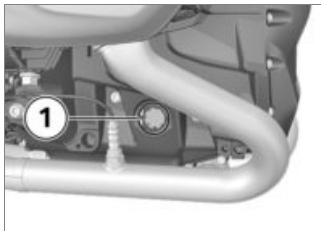

- Check the oil level in oil-level indicator **1**.

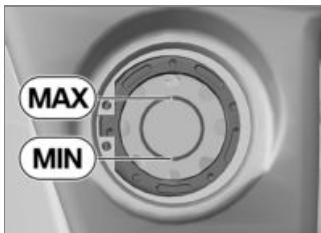

Engine oil, specified level

Between MIN and MAX marks

If the oil level is below the MIN mark:

- Topping up the engine oil (→ 123).

If the oil level is above the MAX mark:

- Have the oil level corrected by a specialist workshop, preferably an authorised BMW Motorrad dealer.

## Topping up the engine oil

- Make sure the ground is level and firm and place the motorcycle on its stand.

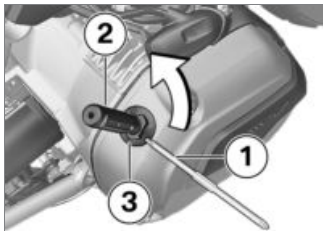

- Wipe the area around the oil filler neck clean.
- Insert Torx end of reversible screwdriver insert **1** into screwdriver handle **2** (on-board toolkit) for additional leverage.
- Insert the screwdriver handle into cap **3**.
- Turn cap **3** counter-clockwise to remove.
- Checking engine oil level (▶▶▶ 122).



### ATTENTION

**Use of insufficient engine oil or too much engine oil**

#### Engine damage

- Always make sure that the oil level is correct. ◀
- Top up the engine oil to the specified level.



Engine oil, quantity for topping up

max 0.95 l (Difference between MIN and MAX)

- Checking engine oil level (▶▶▶ 122).
- Install cap **3** of the oil filler neck.

## Brake system

### Checking function of brakes

- Pull the front brake lever.
  - » The pressure point must be clearly perceptible.
- Press the footbrake lever.
  - » The pressure point must be clearly perceptible.

If pressure points are not clearly perceptible:



### ATTENTION

**Work on brake system not in compliance with correct procedure**

Risk to operational reliability of the brake system

- Have all work on the brake system undertaken by trained and qualified specialists. ◀
- Have the brakes checked by a specialist workshop, preferably an authorised BMW Motorrad dealer.

### Checking front brake pad thickness

- Make sure the ground is level and firm and place the motorcycle on its stand.

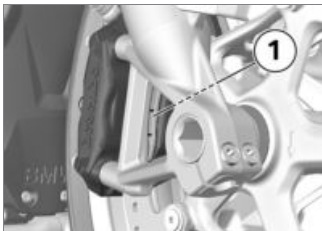

- Visually inspect the left and right brake pads to ascertain their thickness. Viewing direction: between wheel and front suspension toward brake pads **1**.



 Brake-pad wear limit, front

1.0 mm (Friction pad only, without backing plate. The wear indicators (grooves) must be clearly visible.)

If the wear indicating marks are no longer clearly visible:

 **WARNING**

**Brake-pad thickness less than permissible minimum**

Diminished braking effect, damage to the brakes

- In order to ensure the dependability of the brake system, do not permit the brake pads to wear past the minimum permissible thickness. ◀
- Have the brake pads replaced by a specialist workshop, preferably an authorised BMW Motorrad dealer.

## Check rear brake pad thickness

- Make sure the ground is level and firm and place the motorcycle on its stand.

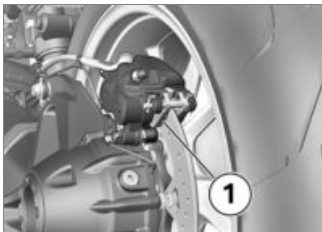

- Visually inspect the brake pads to ascertain their thickness. Viewing direction: From the rear toward brake pads **1**.



Brake-pad wear limit,  
rear

1.0 mm (Friction pad only,  
without backing plate)

If the wear limit has been reached:



### WARNING

#### Brake-pad thickness less than permissible minimum

Diminished braking effect, damage to the brakes

- In order to ensure the dependability of the brake system, do not permit the brake pads to

wear past the minimum permissible thickness. ◀

- Have the brake pads replaced by a specialist workshop, preferably an authorised BMW Motorrad dealer.

### Checking brake-fluid level, front brakes



### WARNING

#### Not enough brake fluid in brake fluid reservoir

Considerably reduced braking power due to air in the brake system

- Check the brake-fluid level at regular intervals. ◀
- with centre stand<sup>OE</sup>
- Make sure the ground is level and firm and place the motorcycle on its centre stand. ◀



- without centre stand<sup>OE</sup>
- Make sure the ground is level and firm and hold the motor-cycle upright.◀
- Turn the handlebars to a position in which the brake fluid reservoir is horizontal.



- Check the brake fluid level in front reservoir **1**.

### NOTICE

Wear of the brake pads causes the brake fluid level in the reservoir to sink.◀



 Brake fluid level, front

Brake fluid, DOT4

It is impermissible for the brake fluid level to drop below the MIN mark. (Brake-fluid reservoir horizontal, motorcycle upright)

If the brake fluid level drops below the permitted level:

- Have the defect rectified as quickly as possible by a specialist workshop, preferably an authorised BMW Motorrad dealer.

## Checking the brake-fluid level, rear brakes

### WARNING

#### Not enough brake fluid in brake fluid reservoir

Considerably reduced braking power due to air in the brake system

- Check the brake-fluid level at regular intervals.◀

– with centre stand<sup>OE</sup>

- Make sure the ground is level and firm and place the motorcycle on its centre stand.◀

– without centre stand<sup>OE</sup>

- Make sure the ground is level and firm and hold the motorcycle upright.◀

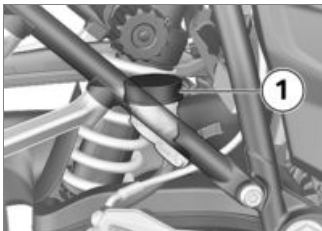

- Check the brake fluid level in rear reservoir **1**.



### NOTICE

Wear of the brake pads causes the brake fluid level in the reservoir to sink. ◀



Brake fluid level, rear

Brake fluid, DOT4

It is impermissible for the brake fluid level to drop below the MIN mark. (Brake-fluid reservoir horizontal, motorcycle upright)

If the brake fluid level drops below the permitted level:

- Have the defect rectified as quickly as possible by a specialist workshop, preferably an authorised BMW Motorrad dealer.

## Clutch

### Checking clutch function

- Pull the clutch lever.
  - » The pressure point must be clearly perceptible.
- If the pressure point is not clearly perceptible:

- Have the clutch checked by a specialist workshop, preferably an authorised BMW Motorrad dealer.

## Coolant

### Check coolant level

- Extend the side stand and take up a position on the right side of the motorcycle.
- Hold the motorcycle upright. – with centre stand<sup>OE</sup>
- Make sure the ground is level and firm and place the motorcycle on its centre stand. ◀



### CAUTION

#### Hot engine

Risk of burn injury

- Keep clear of all hot engine components.
- Do not touch hot engine components. ◀
- Check the coolant level in expansion tank **1**.
  - » The coolant level must be between the MIN and MAX marks.

If the coolant level drops below the MIN mark:

- Top up the coolant.

#### Top up coolant

- Check coolant level (▶▶▶ 128).



- Open cap **1** of the coolant expansion tank and top up the coolant to the specified level.
- Check coolant level (▶▶▶ 128).
- Close cap **1** of the coolant expansion tank.

## Tyres

### Checking tyre pressure

#### WARNING

#### Incorrect tyre pressure

Impaired handling characteristics of the motorcycle, shorter useful tyre life

- Always check that the tyre pressures are correct. ◀



#### WARNING

#### Tendency of valve inserts installed vertically top open by themselves at high riding speeds.

Sudden loss of tyre pressure.

- Install valve caps fitted with rubber sealing rings and tighten firmly. ◀
- Make sure the ground is level and firm and place the motorcycle on its stand.

- Check tyre pressures against the data below.

 Tyre pressure, front
2.5 bar (tyre cold)
 Tyre pressure, rear
2.9 bar (tyre cold)

If tyre pressure is too low:

- Correct tyre pressure.

## Rims and tyres

### Checking rims

- Make sure the ground is level and firm and place the motorcycle on its stand.
- Visually inspect the rims for defects.
- Have any damaged rims inspected by a specialist workshop and replaced if neces-

sary, preferably by an authorised BMW Motorrad dealer.

### Checking tyre tread depth



#### WARNING

#### Riding with badly worn tyres

Risk of accident due to impaired handling

- If applicable, have the tyres changed in good time before they wear to the minimum tread depth permitted by law.◀
- Make sure the ground is level and firm and place the motorcycle on its stand.
- Measure the tyre tread depth in the main tread grooves with wear marks.



#### NOTICE

Wear indicators are built into the main profile grooves on each tyre. The tyre is worn out when the tyre tread has worn down

to the level of the marks. The locations of the marks are indicated on the edge of the tyre, e.g. by the letters TI, TWI or by an arrow.◀

If the tyre tread is worn to minimum:

- Replace tyre or tyres, as applicable.

## Wheels

### Tyre recommendation

For each size of tyre, BMW Motorrad tests and classifies as roadworthy certain makes. BMW Motorrad cannot assess the suitability or provide any guarantee of road safety for other tyres.

BMW Motorrad recommends using only tyres tested by BMW Motorrad.

Detailed information is available from your authorised

BMW Motorrad dealer or in the internet at

**bmw-motorrad.com**

## Effect of wheel size on chassis and suspension control systems

Wheel size is very important as a parameter for the frame and suspension control systems ABS and ASC/DTC. In particular, the diameter and the width of the vehicle's wheels are programmed into the control unit and are fundamental to all calculations. Any change in these influencing variables, caused for example by a switch to wheels other than those installed ex-works, can have serious effects on the performance of the control systems. The sensor rings are essential for correct road-speed calculation, and they too must match the motorcycle's control sys-

tems and consequently cannot be changed.

If you decide that you would like to fit non-standard wheels to your motorcycle, it is very important to consult a specialist workshop beforehand, preferably an authorised BMW Motorrad dealer. In some cases, the data programmed into the control units can be changed to suit the new wheel sizes.

### RDC adhesive label

– with tyre pressure monitoring (RDC)<sup>OE</sup>

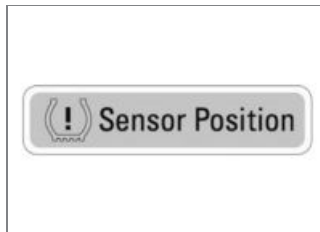

### Tyre removal not in compliance with correct procedure

Damage to RDC sensors

- Be sure to explain to the specialist workshop or authorised BMW Motorrad dealer that the wheel is fitted with an RDC sensor.◀

If the motorcycle is equipped with RDC, each wheel rim bears an adhesive label indicating the position of the RDC sensor. When a tyre is being changed, special care must be taken not

to damage the RDC sensor. Be sure to draw the attention of the authorised BMW Motorrad dealer or specialist workshop to the fact that the wheel is fitted with an RDC sensor.

## Removing front wheel

- Place the motorcycle on an auxiliary stand; BMW Motorrad recommends the BMW Motorrad rear-wheel stand.
- Install the rear-wheel stand (→ 122).  
– with centre stand<sup>OE</sup>
- Make sure the ground is level and firm and place the motorcycle on its centre stand.◀

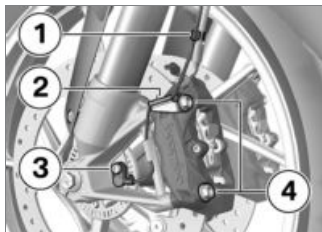

- Disengage the cable for the wheel-speed sensor from retaining clips **1** and **2**.
- Remove screw **3** and remove the wheel-speed sensor from its bore.
- Mask off the parts of the wheel rim that could be scratched in the process of removing the brake calipers.



### ATTENTION

#### Unwanted inward movement of the brake pads

Component damage on attempt to install the brake caliper or be-

cause brake pads have to be forced apart

- Do not operate the brakes with a brake caliper not correctly secured.◀
- Remove securing screws **4** of the left and right brake calipers.

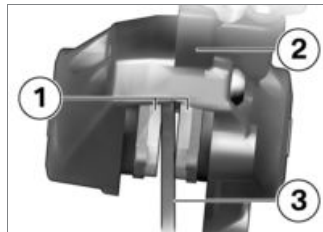

- Force the brake pads **1** slightly apart by rotational movement of the brake caliper **2** against brake disc **3**.
- Carefully pull the brake calipers back and out until clear of the brake discs.

- Lift the front of the motorcycle until the front wheel is clear of the ground, preferably using a BMW Motorrad front-wheel stand.
- Installing the front-wheel stand (➔ 120).



- Slacken axle clamping screws **1**.

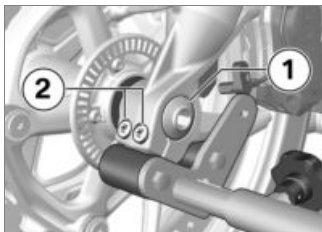

- Remove screw **1**.
- Slacken axle clamping screws **2**.
- Press quick-release axle slightly toward the inside, so as to be better able to grip it on the right-hand side.



- Withdraw quick-release axle **1**, support the front wheel when doing this.
- Set down front wheel and roll forwards out of the front suspension.

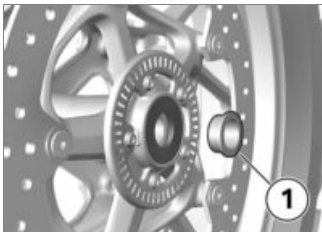

- Remove spacer bush **1** from the wheel hub.

### Installing front wheel



#### WARNING

#### Use of a non-standard wheel

Malfunctions during ABS and ASC/DTC intervention

- See the information on the effect of wheel size on the ABS and ASC/DTC systems at the start of this chapter.◀



#### ATTENTION

#### Tightening threaded fasteners to incorrect tightening torque

Damage, or threaded fasteners work loose

- Always have the security of the fasteners checked by a specialist workshop, preferably an authorised BMW Motorrad dealer.◀

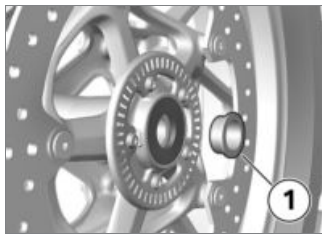

- Slip spacing bushing **1** into the wheel hub on the left-hand side.



#### ATTENTION

#### Front wheel installed wrong way round

Risk of accident

- Note direction-of-rotation arrows on tyre or rim.◀
- Roll the front wheel into position between the front forks.

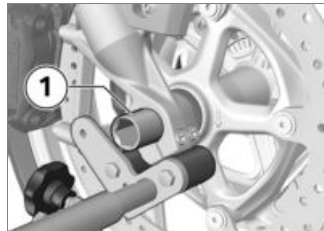

- Lift front wheel and fit quick-release axle **1**.
- Remove front-wheel stand and firmly compress front forks several times. Do not operate front break lever.



- Installing the front-wheel stand (→ 120).

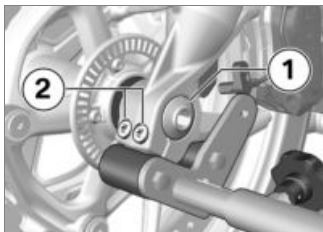

- Install screw **1** and tighten to specified torque. Counter-hold quick-release axle on the right-hand side.

 Quick-release axle in telescopic forks

50 Nm

- Tighten axle clamping screws **2** to the specified tightening torque.



 Clamping screws in axle holder

Tightening sequence: Tighten screws six times in alternate sequence

19 Nm



- Tighten axle clamping screws **1** to the specified tightening torque.



Clamping screws in axle holder

Tightening sequence: Tighten screws six times in alternate sequence

19 Nm

- Removing the front-wheel stand.
- Position left and right brake calipers on the brake discs.

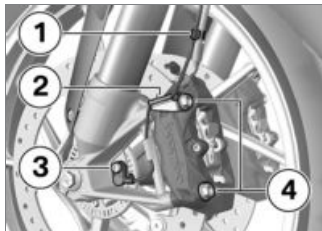

- Install securing screws **4** on left and right and tighten to specified tightening torque.



Brake caliper on telescopic fork

38 Nm

- Remove the adhesive tape from the wheel rim.



### WARNING

#### Brake pads not lying against the brake disc

Risk of accident due to delayed braking effect.

- Before driving, check that the brakes respond without delay. ◀
- Operate the brake several times until the brake pads are bedded.
- Seat the cable for the wheel-speed sensor in retaining clips **1** and **2**.
- Insert the wheel-speed sensor into the bore and install screw **3**.



Wheel-speed sensor to fork leg

Joining compound: Micro-encapsulated or medium-strength thread-locking compound

8 Nm

#### Removing rear wheel

- Swivelling silencer (▶▶ 138).



- Engage first gear.
- Remove studs **1** from the rear wheel, while supporting the wheel.
- Roll the rear wheel out toward the rear.

## Installing the rear wheel

### **WARNING**

#### Use of a non-standard wheel

Malfunctions during ABS and ASC/DTC intervention

- See the information on the effect of wheel size on the ABS

and ASC/DTC systems at the start of this chapter. ◀



### **ATTENTION**

#### Tightening threaded fasteners to incorrect tightening torque

Damage, or threaded fasteners work loose

- Always have the security of the fasteners checked by a specialist workshop, preferably an authorised BMW Motorrad dealer. ◀
- Seat the rear wheel on the rear-wheel adapter.



- Install wheel studs **1** and tighten to specified torque.



Rear wheel to wheel flange

Tightening sequence: tighten in diagonally opposite sequence

60 Nm

- Securing silencer (▶▶▶ 139).

## Silencer

### Swivelling silencer

**CAUTION**

#### Hot exhaust system

Risk of burn injury

- Do not touch a hot exhaust system. ◀
- Allow rear silencer to cool down.
- Make sure the ground is level and firm and place the motorcycle on a suitable auxiliary stand; BMW Motorrad recommends the BMW Motorrad rear-wheel stand.
- Install the rear-wheel stand (→ 122).
- with centre stand<sup>OE</sup>
- Make sure the ground is level and firm and place the motorcycle on its centre stand. ◀

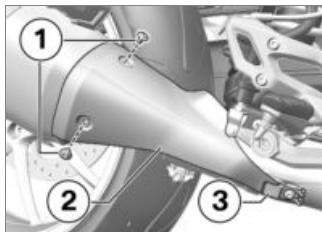

- Remove screws **1**.
- Ease cover **2** out of holder **3** and remove.

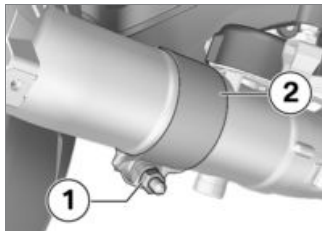

- Slacken nut **1** to loosen clamp **2** slightly.

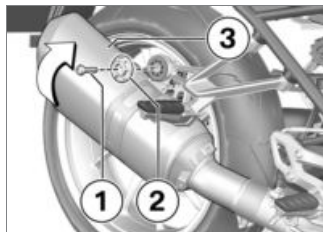

- Remove screw **1** and washer **2**.
- Turn silencer **3** counter-clockwise.

### Securing silencer

**ATTENTION**

#### Tightening threaded fasteners to incorrect tightening torque

Damage, or threaded fasteners work loose

- Always have the security of the fasteners checked by a specialist workshop, preferably

an authorised BMW Motorrad dealer. ◀

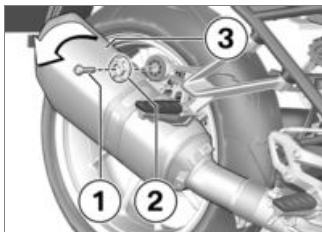

- Turn silencer **3** clockwise until it is seated against the rear footrest bracket.
- Install screw **1** and washer **2**.

 Silencer to rear frame

19 Nm

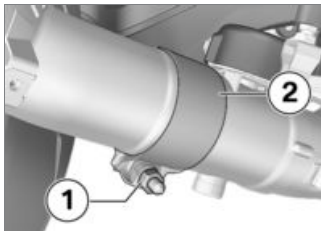

- Tighten nut **1** of clamp **2**.

 Clamp to silencer and exhaust manifold

22 Nm

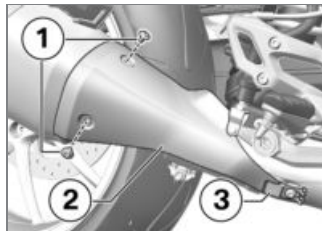

- Secure cover **2** in holder **3** and hold in position.
- Install screws **1**.

## Light source

### Replacing bulbs for low-beam and high-beam headlight



#### NOTICE

The positions of the plugs and the bulbs might not be as illustrated below. ◀

 **NOTICE**

The procedure described here for replacing the low-beam headlight bulb applies by analogy for the high-beam headlight bulb. ◀

- Make sure the ground is level and firm and place the motorcycle on its stand.
- Switch off the ignition.
- with windscreen, Pure<sup>OE</sup>

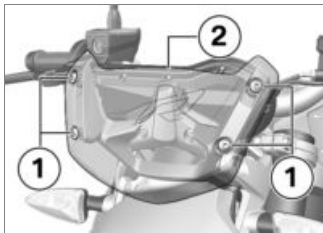

- Remove screws **1**. Make sure that the shouldered bushings from the grommets are not mislaid.

- Remove windscreen **2**. ◀

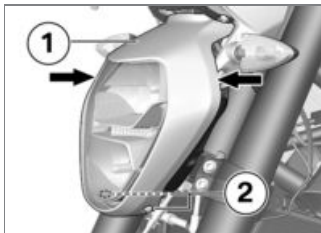

- Remove screws **2** and initially ease cover **1** out slightly at the top and then remove.



- Slacken screw **1** through **2** turns.

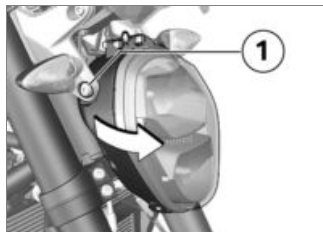

- Remove screw **1** and swivel the headlight aside.



- Press retaining hooks **2** down slightly and remove cover **1** by pulling retaining hooks **2**.

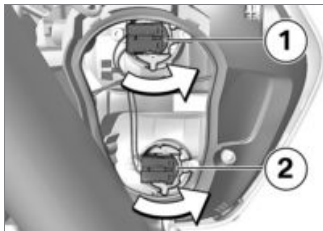

- Turn plug with bulb **1** for the low-beam headlight counter-clockwise and remove it.
- Turn plug with bulb **2** for the high-beam headlight counter-clockwise and remove it.

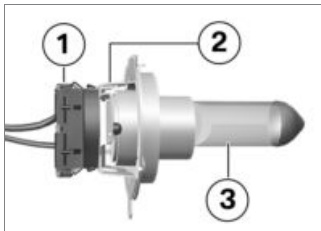

- Use a clean, dry cloth to hold the bulb in order to keep the glass free of dirt and foreign matter.
- Hold the bulb by the base only, in order to keep the glass free of foreign matter.
- Remove bulb **3** from plug **1**. Make sure that holder **2** remains on the plug.
- Replace the defective bulb.

	<p>Bulbs for the low-beam headlight</p>
<p>H7 / 12 V / 55 W</p>	

	<p>Bulb for high-beam headlight</p>
<p>H7 / 12 V / 55 W</p>	

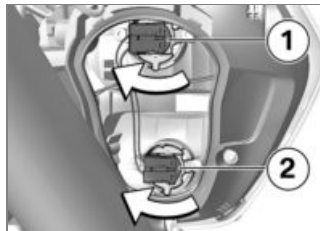

- Insert plug with bulb **1** for the low-beam headlight into the light housing and turn it clockwise.
- Insert plug with bulb **2** for the high-beam headlight into the light housing and turn it clockwise.



- Hold the cover in position at the bottom on connector **2** and secure retaining hooks **1** at the top.

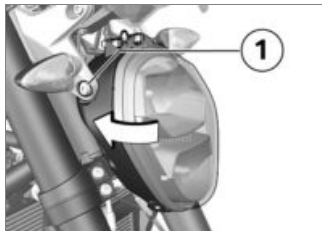

- Swing the headlight back to its original position and install screw **1**.



Headlight to front panel carrier

19 Nm



- Tighten screw **1**.



Adjuster to headlight

8 Nm



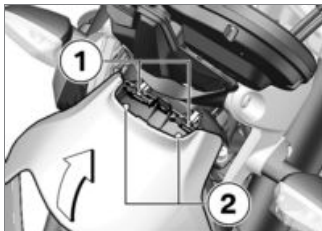

- Clip both retaining hooks **2** into holders **1**.

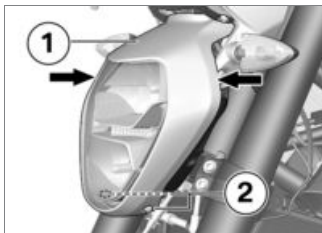

- Engage cover **1** at the bottom and install screws **2**.

– with windscreen, Pure<sup>OE</sup>

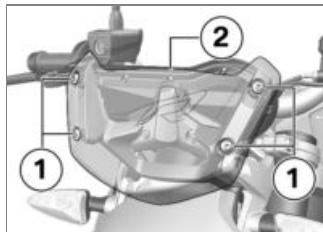

- Place windscreen **2** in position.
- Install screws **1**.



Windscreen to holder

- with windscreen, Sport<sup>OE</sup> or
- with windscreen, Pure<sup>OE</sup> or
- with windscreen, sports<sup>OA</sup> or
- with windscreen, high<sup>OA</sup>

4 Nm<<

## Replacing bulb for parking light

- Place the motorcycle on its stand on firm, even ground.
- Switch off the ignition.
- with windscreen, Pure<sup>OE</sup>

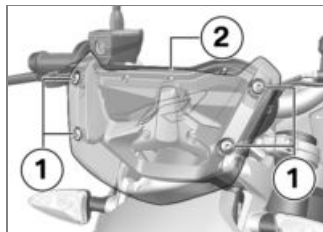

- Remove screws **1**. Make sure that the shouldered bushings from the grommets are not mislaid.
- Remove windscreen **2**.<

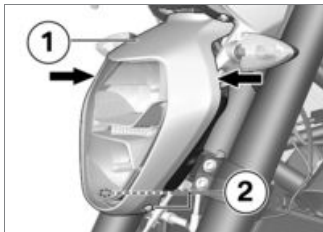

- Remove screws **2** and remove cover **1**.



- Slacken screw **1** through 2 turns.

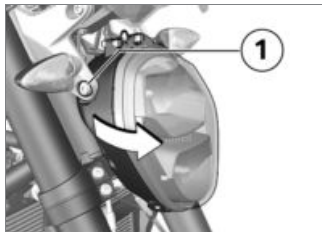

- Remove screw **1** and swivel the headlight aside.



- Remove cover **1** by pulling retaining hooks **2**.



- Pull socket **1** out of the headlight housing.
- Use a clean, dry cloth to hold the bulb in order to keep the glass free of dirt and foreign matter.



- Remove bulb **1** from the socket.
- Replace the defective bulb.



Bulb for parking light

W5W / 12 V / 5 W

– with Pro Headlight<sup>OE</sup>

LED<



- Insert bulb **1** into the socket.

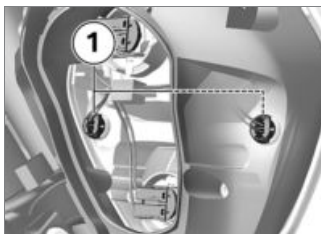

- Insert socket **1** into the headlight housing.



- Hold the cover in position at the bottom on connector **2** and secure retaining hooks **1** at the top.

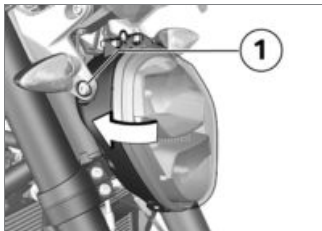

- Swing the headlight back to its original position and install screw **1**.



Headlight to front panel carrier

19 Nm



- Tighten screw **1**.



Adjuster to headlight

8 Nm

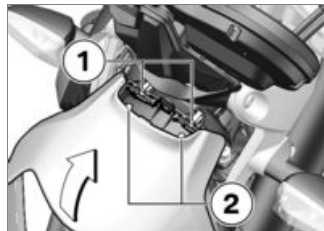

- Clip both retaining hooks **2** into holders **1**.

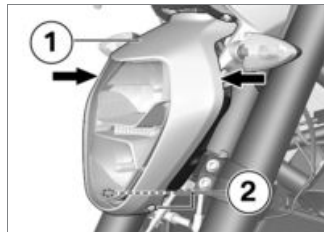

- Engage cover **1** at the bottom and install screws **2**.

– with windscreen, Pure<sup>OE</sup>

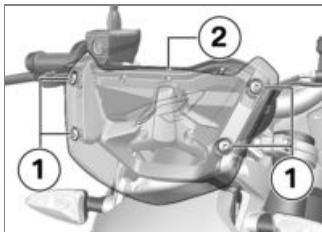

- Place windscreen **2** in position.
- Install screws **1**.



Windscreen to holder

- with windscreen, Sport<sup>OE</sup>  
or
- with windscreen, Pure<sup>OE</sup>  
or
- with windscreen, sports<sup>OA</sup>  
or
- with windscreen, high<sup>OA</sup>

4 Nm <<

## Replacing bulbs for front and rear turn indicators

- Place the motorcycle on its stand on firm, even ground.
- Switch off the ignition.



- Remove screw **1**.



- Pull the glass out of the light housing at the threaded-fastener side.

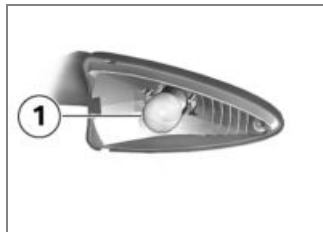

- Use a clean, dry cloth to hold the bulb in order to keep the glass free of foreign matter.

- Turn bulb **1** counter-clockwise and remove it from the light housing.
- Replace the defective bulb.



Bulbs for flashing turn indicators, front

RY10W / 12 V / 10 W

– with LED turn indicators<sup>OE</sup>

LED<



Bulbs for flashing turn indicators, rear

RY10W / 12 V / 10 W

– with LED turn indicators<sup>OE</sup>

LED<

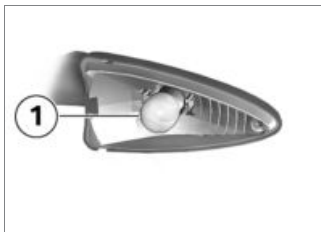

- Turn bulb **1** clockwise to install it in the light housing.



- Working from the inboard side, insert the glass into the light housing and close the housing.



- Install screw **1**.

### Replacing bulb for number-plate light

- Removing front seat (→ 80).
- Make sure the ground is level and firm and place the motorcycle on its centre stand.

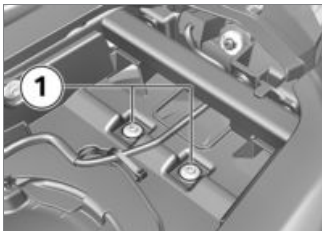

- Remove screws **1**.



- Pull number-plate light bulb **4** out of the light housing.



- Remove screws **2** and remove cover for number-plate carrier **3**.



- Remove bulb **5** from the socket.

- Replace the defective bulb.

 Light source for the number plate light

W5W / 12 V / 5 W

- Use a clean, dry cloth to hold the bulb in order to keep the glass free of foreign matter.

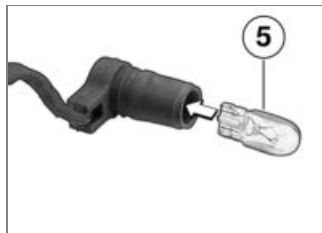

- Press bulb **5** into the socket.



- Press number-plate light bulb **4** into the light housing.

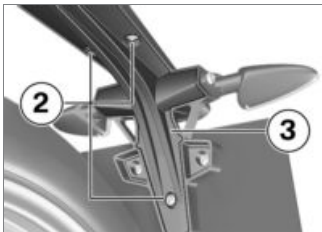

- Place cover for number-plate carrier **3** in position and install screws **2**.

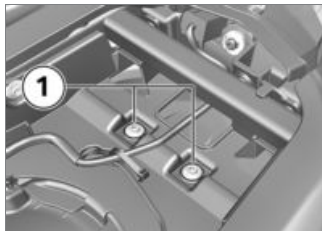

- Install screws **1**.
- Installing front seat (☞ 80).

### Replacing LED rear light

The LED rear light can be replaced only as a complete unit.

- Consult a specialist workshop, preferably an authorised BMW Motorrad dealer.

### Replacing LED turn indicators

– with LED turn indicators<sup>OE</sup>

LED turn indicators can be replaced only as a complete unit.

- Consult a specialist workshop, preferably an authorised BMW Motorrad dealer.

### Replacing LED daytime riding light

– with daytime running light<sup>OE</sup>

The LED daytime riding light can only be replaced as a unit with the headlight; it is not possible to replace individual LEDs.

- Consult a specialist workshop, preferably an authorised BMW Motorrad dealer.

### Replacing LED additional headlights

– with LED auxiliary headlights<sup>OA</sup>

LED auxiliary headlights can be replaced only as a complete unit.



- Consult a specialist workshop, preferably an authorised BMW Motorrad dealer.

## Jump-starting

### ATTENTION

#### Excessive current flowing when the motorcycle is jump-started

Wiring smoulders/ignites or damage to the on-board electronics

- If the motorcycle has to be jump-started connect the leads to the battery terminals; never attempt to jump-start the engine by connecting leads to the on-board socket.◀

### ATTENTION

#### Contact between crocodile clips of jump leads and vehicle

Risk of short-circuit

- Use jump leads fitted with fully insulated crocodile clips at both ends.◀

### ATTENTION

#### Jump-starting with a voltage greater than 12 V

Damage to the on-board electronics

- Make sure that the battery of the donor vehicle has a voltage rating of 12 V.◀
- Place the motorcycle on its stand on firm, even ground.
- Removing battery cover (▶ 154).
- When jump-starting the engine, do not disconnect the battery from the on-board electrical system.

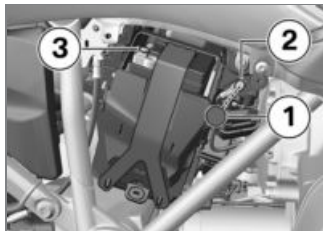

- Remove protective cap **1**.
- Connect the red jump lead to the positive battery connection point **2** of the drained battery and the positive terminal of the donor battery.
- Then connect one end of the black jump lead to the negative terminal of the donor battery and the other end to negative terminal **3** of the discharged battery.
- Run the engine of the donor vehicle during jump-starting.
- Start the engine of the vehicle with the discharged battery in the usual way; if the en-

gine does not start, wait a few minutes before repeating the attempt in order to protect the starter motor and the donor battery.

- Allow both engines to idle for a few minutes before disconnecting the jump leads.
- Disconnect the jump lead from the negative terminals first, then disconnect the second lead from the positive terminals.

### NOTICE

Do not use proprietary start-assist sprays or other products to start the engine. ◀

- Install the protective cap.
- Fitting battery cover (▣▶ 155).

## Battery

### Maintenance instructions

Correct upkeep, recharging and storage will prolong the life of the battery and are essential if warranty claims are to be considered.

Compliance with the points below is important in order to maximise battery life:

- Keep the surface of the battery clean and dry.
- Do not open the battery.
- Do not top up with water.
- Be sure to read and comply with the instructions for charging the battery on the following pages.
- Do not turn the battery upside down.



### ATTENTION

#### **On-board electronics (e.g. clock) draining connected battery**

Battery is deep-discharged; this voids the guarantee

- Connect a float charger to the battery if the motorcycle is to remain out of use for more than four weeks. ◀



### NOTICE

BMW Motorrad has developed a float charger specially designed for compatibility with the electronics of your motorcycle. Using this charger, you can keep the battery charged during long periods of disuse, without having to disconnect the battery from the motorcycle's on-board systems. You can obtain additional information from your authorised BMW Motorrad dealer. ◀

## Charge battery when connected

### ATTENTION

#### Charging the battery that is connected to the vehicle via the battery terminals

Damage to the on-board electronics

- Disconnect the battery at the battery terminals before charging.◀

### ATTENTION

#### Charging a fully discharged battery via the socket or the extra socket

Damage to the on-board electronics

- If a battery has discharged to the extent that it is completely flat (battery voltage less than 9 V, status-indicator lights and multifunction display remain off when the ignition is switched

on) **it has to be disconnected from the on-board circuits** and re-charged with the charger connected directly to the battery posts.◀

### ATTENTION

#### Unsuitable chargers connected to a socket

Damage to charger and vehicle electronics

- Use suitable BMW chargers. The suitable charger is available from your authorised BMW Motorrad dealer.◀
- Charge via the charging socket, with the battery connected to the motorcycle's on-board electrical system.

### NOTICE

The motorcycle's on-board electronics know when the battery is fully charged. The on-board

socket is switched off when this happens.◀

- Comply with the operating instructions of the charger.

### NOTICE

If you are unable to charge the battery through the on-board socket, you may be using a charger that is not compatible with your motorcycle's electronics. If this happens, charge the battery directly at the terminals of the battery that is disconnected from the vehicle.◀

#### Charge battery when disconnected

- Charge the battery using a suitable charger.
- Comply with the operating instructions of the charger.
- Once the battery is fully charged, disconnect the

charger's terminal clips from the battery terminals.

### NOTICE

The battery has to be recharged at regular intervals in the course of a lengthy period of disuse. See the instructions for caring for your battery. Always fully recharge the battery before restoring it to use.◀

## Removing battery

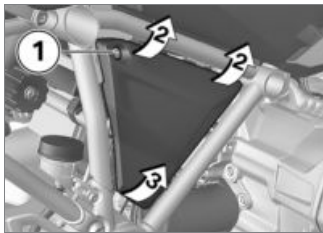

- Switch off the ignition.
- Remove screw **1**.

- Each battery cover slightly forward at the top at positions **2**.
- In order not to damage the battery cover or the mount, work the battery cover up at position **3** to remove.

– with alarm system (DWA)<sup>OE</sup>

- If applicable, switch off the anti-theft alarm.◀

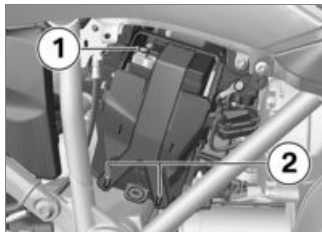

- Disconnect battery negative lead **1** and disengage rubber strap **2**.



- Pull retaining plate in position **1** outwards and remove in an upward direction.
- Slightly lift the battery and ease it clear of the holder until the battery positive terminal is accessible.

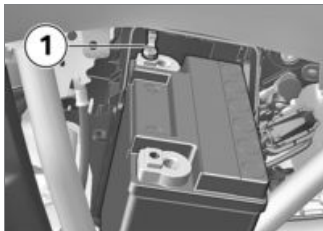

- Disconnect battery negative lead **1** and remove the battery.

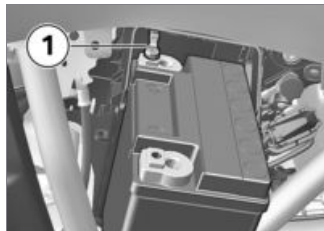

- Secure battery positive lead **1**.
- Push battery into the mounting.



- Secure battery negative lead **1**.
- Secure the battery with rubber strap **2**.

## Installing battery

### NOTICE

If the 12 V battery is not correctly installed or if the polarity of the terminals is reversed (e.g. in an attempt to jump-start the vehicle), this can cause the fuse for the alternator regulator to blow. ◀

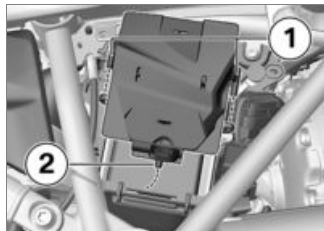

- First insert retaining plate into the mountings **1** and then push under the battery in position **2**.

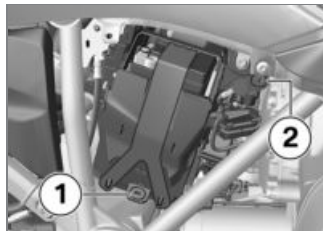

- Place battery cover into the mounting **1** and press into the mountings **2**.

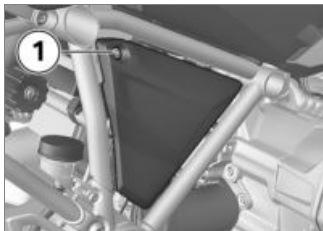

- Install screw **1**.
- Setting the clock (➡ 64).
- Setting the date (➡ 65).

## Fuses

### Replace fuses

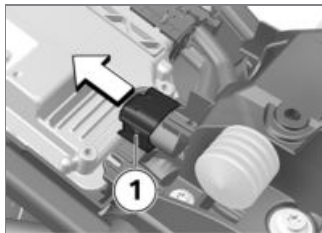

- Switch off the ignition.
- Removing front seat (➡ 80).
- Disconnect plug **1**.

### ATTENTION

#### Jumpering of blown fuses

Risk of short-circuit and fire

- Never attempt to jumper a blown fuse.
- Always replace a defective fuse with a new fuse of the same amperage.◀

- Replace faulty fuse in accordance with the fuse allocation diagram.

### NOTICE

If fuse defects recur frequently have the electric circuits checked by a specialist workshop, preferably an authorised BMW Motorrad dealer.◀

- Install plug **1**.
- Installing front seat (➡ 80).

## Fuse assignment

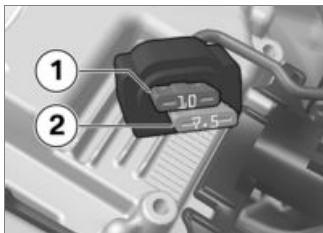

 Fuse carrier 1

10 A (Slot 1: instrument cluster, alarm system (DWA), ignition lock, main relay, diagnostic socket)

7.5 A (Slot 2: multifunction switch left, tyre pressure control (RDC), angular rate sensor)

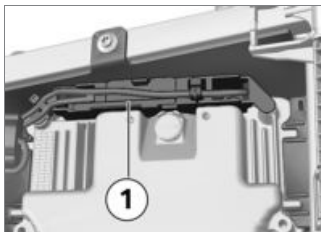

 Fuse holder

50 A (Fuse 1: Voltage regulator)

## Diagnostic connector Disengaging diagnostic connector

 **CAUTION**

**Incorrect procedure followed when loosening the**

## diagnostic connector for the on-board diagnosis

Motorcycle experiences malfunctions

- Only have the diagnostic connector loosened by a specialist workshop or other authorised persons during your next BMW Service appointment.
- Have the work performed by appropriately trained staff.
- Refer to the vehicle manufacturer specifications. ◀
- Removing battery cover (▶▶ 154).

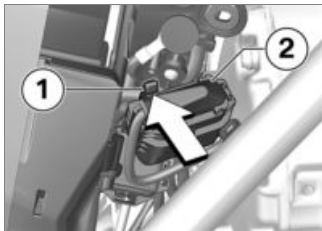

- Press the hook **1** and pull out the diagnostic connector **2** towards the top.

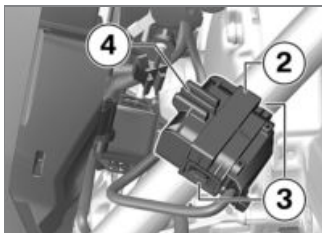

- Press the locks **3** on both sides.

- Loosen the diagnostic connector **2** from the bracket **4**.  
» The interface to the diagnosis and information system can be connected to diagnostic connector **2**.

### Securing the diagnostic connector

- Disconnect the interface for the diagnosis and information system.

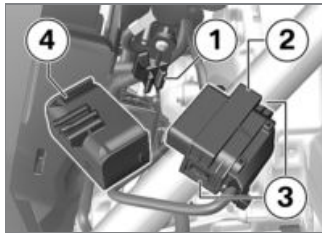

- Insert the diagnostic connector **2** into the bracket **4**.  
» The locks **3** engage on both sides.

- Connect the bracket **4** to the mounting **1**.



- Make sure the hook **5** engages.
- Fitting battery cover (→ 155).



## **Accessories**

General instructions.....	160
Power sockets .....	160
Cases.....	161
Topcase .....	164
Navigation system .....	167

## General instructions

### CAUTION

#### Use of other-make products

Safety risk

- BMW Motorrad cannot examine or test each product of outside origin to ensure that it can be used on or in connection with BMW vehicles without constituting a safety hazard. Country-specific official authorisation does not suffice as assurance. Tests conducted by these instances cannot make provision for all operating conditions experienced by BMW vehicles and, consequently, they are not sufficient in some circumstances.
- Use only parts and accessories approved by BMW for your vehicle. ◀

BMW has conducted extensive testing of the parts and ac-

cessory products to establish that they are safe, functional and suitable. Consequently, BMW accepts product liability. BMW accepts no liability whatsoever for parts and accessories that it has not approved.

Whenever you are planning modifications, comply with all the legal requirements. Make sure that the vehicle does not infringe the national road-vehicle construction and use regulations applicable in your country. Your BMW Motorrad dealer can offer expert advice on the choice of genuine BMW parts, accessories and other products. To find out more about accessories go to:

**[bmw-motorrad.com/  
accessories](http://bmw-motorrad.com/accessories)**

## Power sockets

### Connection of electrical devices

- You can start using electrical devices connected to the motorcycle's sockets only when the ignition is switched on.

### Cable routing

- The cables from the power sockets to the auxiliary devices must be routed in such a way that they do not impede the rider.
- The cable routing should not restrict the steering angle or obstruct handling.
- The cables must not be trapped.

### Automatic shutdown

- The sockets will be automatically switched off during the start procedure.

- The power supply to the sockets is switched off no more than 15 minutes after the ignition is switched off, in order to prevent overloading of the on-board electrics. Low-wattage electrical accessories might not be recognised by the vehicle's electronics. In such cases, power sockets are switched off very shortly after the ignition is turned off.
- If the battery charge state is too low to maintain the motorcycle's start capability, the power sockets are switched off.
- The power sockets are also switched off when the maximum load capability as stated in the technical data is exceeded.

## Cases

### Open cases

- with touring cases<sup>OA</sup>

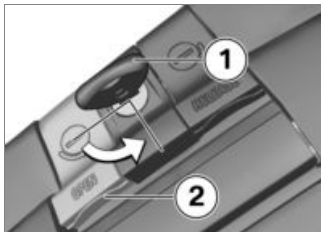

- Turn the key **1** to position OPEN.
- Pull the grey release lever **2** (OPEN) all the way up and simultaneously open the case lid.

### Closing cases

- with touring cases<sup>OA</sup>

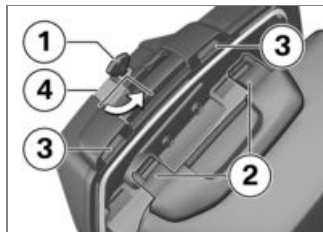

- Turn the key **1** to position OPEN.
- Press catches **2** of the case lid into retainers **3**. Check that nothing is trapped between the lid and the case.
- Pull the grey release lever **4** (OPEN) all the way up and simultaneously open the case lid.
  - » The lid engages with an audible click.
- Turn the key **1** in the case lock so that it is parallel with the direction of travel and remove.

## Removing cases

– with touring cases<sup>OA</sup>

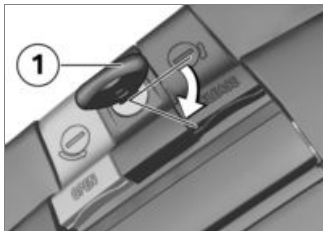

- Turn the key **1** to position RELEASE.



- Pull the black release lever **1** (RELEASE) up and simultaneously pull the case out.
- Then lift the case out of the bottom holder.

## Install cases

– with touring cases<sup>OA</sup>

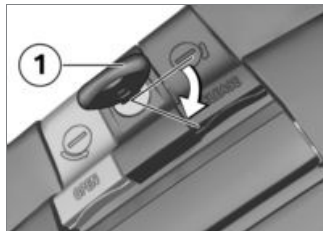

- Turn the key **1** to position RELEASE.

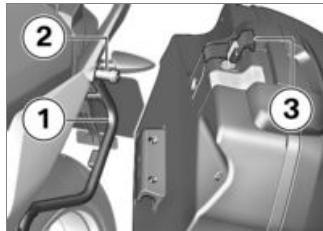

- Position the case in case holder **1**, then pivot it until it is seated at mount **2**.
- Pull the black release lever **3** (RELEASE) up and simultan-



eously push the case into the upper holder **2**.

- Push black release lever **3** (RELEASE) down until it engages.
- Turn the key in the case lock so that it is parallel with the direction of travel and remove.

## Maximum payload and maximum permissible speed

Note the maximum permissible payload and the speed limit for riding with cases fitted, as stated on the label inside the case.

Contact your authorised BMW Motorrad dealer if you cannot find your combination of vehicle and cases on the label. The values for the combination described here are as follows:

 Maximum permissible speed for riding with cases fitted to the motorcycle
max 180 km/h
 Payload per case
max 10 kg

## Secure attachment

– with touring cases<sup>OA</sup>



If a case wobbles or is difficult to fit, it has to be adapted to the

gap between the top and bottom holders.

## WARNING

**Case installation not in compliance with correct procedure.**

Impairment of road safety.

- Cases may not wobble and must be secured free from play. Re-adjust the retainer if play develops over the course of time. ◀

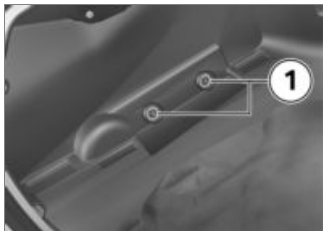

Screws **1** inside the case allow you to make this adjustment.

## Topcase

### Opening topcase

– with topcase<sup>OA</sup>



- Turn the key in the topcase lock to position **1**.



- Push lock barrel **1** forward.  
» Lever **2** pops up.
- Pull the release lever all the way up.

» The lid of the topcase opens.

### Closing topcase

– with topcase<sup>OA</sup>



- Pull release lever **1** all the way up.
- Close the lid of the topcase and hold it down. Check that nothing is trapped between the lid and the case.



### NOTICE

The topcase can also be locked by turning the lock to the LOCK position. In this case, ensure that

the vehicle key is not left in the topcase. ◀



- Push release lever **1** down until it engages.
- Turn the key in the topcase lock to the LOCK position and remove the key from the lock.

### Removing the topcase

– with topcase<sup>OA</sup>



- Turn the key in the topcase lock to position **1**.  
» The handle pops out.



- Pull handle **1** up as far as it will go.

- Lift the topcase at the rear and remove it from the luggage carrier.

### Installing topcase

– with topcase<sup>OA</sup>

#### **WARNING**

#### **Topcase not properly secured**

Driving safety is impaired

- The topcase must not wobble and must be secured free from play. ◀
- Pull the handle up as far as it will go.



- Hook the topcase into position on the luggage carrier. Make sure that hooks **1** are securely seated in the corresponding keepers **2**.



- Push handle **1** down until it engages.



- Turn the key in the topcase lock to position **1** and remove the key from the lock.

## Maximum payload and maximum permissible speed

Note the maximum permissible payload and the speed limit for riding with topcase fitted, as stated on the label inside the topcase.

Contact your authorised BMW Motorrad dealer if you cannot find your combination of vehicle and topcase on the label. The values for the combination described here are as follows:

	Maximum permissible speed for riding with Vario topcase fitted to the motorcycle
--	--

max 180 km/h
--------------

	Payload of Vario topcase
--	--------------------------

max 5 kg
----------



## Navigation system

### Securing navigation system

- with preparation for navigation system<sup>OE</sup>
- with navigation system<sup>OA</sup>

#### NOTICE

The navigation preparation option is compatible with the BMW Motorrad Navigator IV and the BMW Motorrad Navigator V. ◀

#### NOTICE

The latching system of the Mount Cradle is not designed to protect against theft. Always remove the navigation system and stow it away safely as soon as you finish your ride. ◀

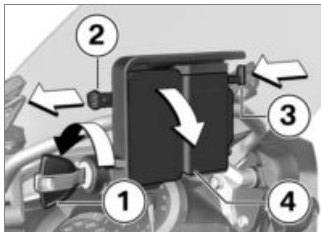

- Turn ignition key **1** counter-clockwise.
- Pull retainer **2** to the **left**.
- Press in lock **3**.
  - » The Mount Cradle is released and cover **4** can be pivoted forward and removed.

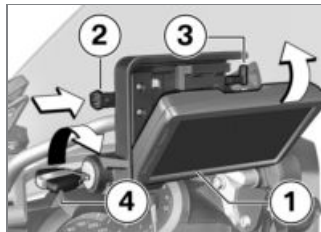

- Insert navigation system **1** at bottom and pivot it toward the rear.
  - » The navigation system engages with an audible click.
- Push retainer **2** fully to the **right**.
  - » Lock **3** is engaged.
- Turn ignition key **4** clockwise.
  - » The navigation system is secured and the ignition key can be removed.

## Removing navigation system and installing cover

- with preparation for navigation system<sup>OE</sup>
- with navigation system<sup>OA</sup>



### ATTENTION

#### Dust and dirt on the Mount Cradle contacts

Damaged contacts

- Always reinstall the cover as soon as you finish your ride.◀

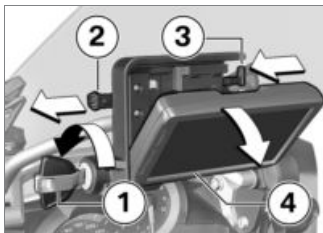

- Turn vehicle key **1** counter-clockwise.

- Pull retainer **2** fully to the **left**.
  - » Lock **3** is disengaged.
- Push lock **3** fully to the **left**.
  - » Navigation system **4** is unlocked.
- Tilt navigation system **4** and work it downward to remove.

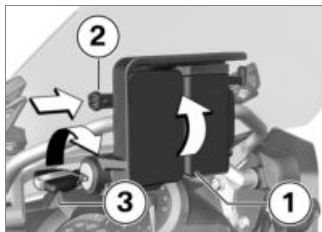

- Insert cover **1** at bottom and pivot it up.
  - » The cover engages with an audible click.
- Push retainer **2** to the **right**.
- Turn vehicle key **3** clockwise.
  - » Cover **1** is secured.

## Operating navigation system

- with preparation for navigation system<sup>OE</sup>
- with navigation system<sup>OA</sup>



### NOTICE

The description below is based on the Navigator V. The Navigator IV does not support all the possibilities described here.◀



### NOTICE

Only the latest version of the BMW Motorrad communication system is supported. A software update of the BMW Motorrad communication system may be necessary. If this is the case, consult your authorised BMW Motorrad dealer.◀

If the BMW Motorrad Navigator is fitted, some of its functions

can be controlled directly from the handlebars using the Multi-Controller.



The Multi-Controller is operated by means of six movements:

- Turning upwards and downwards.
- Short operation to the left and right.
- Extended operation to the left and right.

Turning the Multi-Controller with the Compass or Mediaplayer page open increases or decreases the volume of a

BMW Motorrad communication system connected via Bluetooth. In the BMW special menu, the menu items are selected by turning the Multi-Controller.

Short operation of the Multi-Controller to the left or right changes between the main pages of the Navigator:

- Map view
- Compass
- Mediaplayer
- BMW special menu
- My Motorcycle page

Long-pushing the Multi-Controller corresponds to activating certain functions on the Navigator display. An arrow to the right or to the left above the corresponding button area on the display indicates a function that can be activated in this way.

 Long-push to the right to activate this function.

 Long-push to the left to activate this function.

In detail, the following functions can be controlled:

### **Map view**

- Turn up: Zoom in.
- Turn down: Zoom out.

### **Compass page**

- Turning increases or decreases the volume of a BMW Motorrad communication system connected via Bluetooth.

### **BMW special menu**

- Speak: Repeat most recent navigation announcement.
- Waypoint: Save current location as a favourite.

- Home: Starts navigation to home address (greyed if no home address has been defined).
- Mute: Switch automatic navigation announcements off or on (off: a crossed-out lips symbol appears in the top line of the display). "Speak" will still activate navigation announcements. All other acoustic outputs remain switched on.
- Switch off display: Deactivate the display.
- Dial home number: Dials the home phone number saved in the Navigator (not shown unless a telephone is connected).
- Diversion: Activates the diversion function (not shown unless a route is active).
- Skip: Skips the next waypoint (not shown unless the route has waypoints).

## My Motorcycle

- Turn: Changes the number of data shown.
- Touch a data field on the display to open the menu for selecting data.
- The values available for selection depend on the optional extras installed on the vehicle.



### NOTICE

The Mediaplayer function is available only with a Bluetooth device supporting the A2DP standard, for example a BMW Motorrad communication system. ◀

## Mediaplayer

- Long-push to the left: Play preceding track.
- Long-push to the right: Play next track.
- Turning increases or decreases the volume of a BMW Motorrad communication

system connected via Bluetooth.

## Warnings and status messages

- with navigation system<sup>OA</sup>



Warning and status messages from the motorcycle are indicated by a symbol **1** appearing at the top left in the map view.



### NOTICE

If a BMW Motorrad communication system is connected, warnings are accompanied by an acoustic signal. ◀

If there are two or more active warnings the number appears below the warning triangle.

Touching the warning triangle when more than one warning is active opens a list of all the warnings.

Additional information appears as soon as a message is selected.



## NOTICE

Detailed information cannot be displayed for all warnings. ◀

## Special functions

– with navigation system<sup>OA</sup>

Integration of the BMW Motorrad Navigator has produced a number of deviations from the descriptions in the operating instructions for the Navigator.

## Reserve fuel level warning

The settings for the fuel gauge are not available, because the reserve fuel level warning is sent by the vehicle to the Navigator. Touch the message when it is active to view the locations of the nearest filling stations.

## Time and date

The Navigator sends the time and date to the motorcycle. The transfer of these data into the instrument cluster must be activated in the **SETUP** menu of the instrument cluster.

## Security settings

The BMW Motorrad Navigator V can be secured against unauthorised use with a four-digit PIN (Garmin Lock). If this function is activated, while the Navigator is cradled on the motorcycle and the ignition is switched on you are prompted to add the mo-

torcycle to the list of secured vehicles. If you answer "Yes" at the prompt, the Navigator saves the VIN of this vehicle in its internal memory.

A maximum of five VINs can be saved in this way.

Subsequently, the PIN does not have to be entered when the Navigator is switched on by ignition ON while cradled in any of these vehicles.

If the Navigator is removed from the vehicle while switched on, a security prompt asking for the PIN to be entered is issued.

## Screen brightness

Screen brightness is adjusted by the motorcycle while the unit is cradled. No manual input is necessary.

If you prefer, you can switch off automatic adjustment in the Navigator display settings.



## Care

Care products .....	174
Washing the vehicle .....	174
Cleaning easily damaged components.....	175
Paint care .....	176
Protective wax coating .....	176
Laying up the motorcycle .....	176
Restoring motorcycle to use .....	176

## Care products

BMW Motorrad recommends that you use the cleaning and care products you can obtain from your authorised BMW Motorrad dealer.

The substances in BMW CareProducts have been tested in laboratories and in practice; they provide optimised care and protection for the materials used in your vehicle.

### ATTENTION

#### Use of unsuitable cleaning and care products

Damage to vehicle parts

- Do not use solvents such as cellulose thinners, cold cleaners, fuel or the like, and do not use cleaning products that contain alcohol. ◀

## Washing the vehicle

BMW Motorrad recommends that you use BMW insect remover to soften and wash off insects and stubborn dirt on painted parts prior to washing the vehicle.

To prevent stains, do not wash the vehicle immediately after it has been exposed to strong sunlight and do not wash it in the sun.

Make sure that the vehicle is washed frequently, especially during the winter months.

To remove road salt, clean the motorcycle with cold water immediately after every trip.

### WARNING

**Wet brake discs and brake pads after vehicle wash, after riding through water and in rainy conditions**

Diminished braking effect, risk of accident

- Apply the brakes in good time to allow the friction and heat to dry the brake discs and brake pads. ◀

### ATTENTION

#### Effect of road salt intensified by warm water

Corrosion

- Use only cold water to wash off road salt. ◀

### ATTENTION

#### Damage due to high water pressure from high pressure cleaners or steam cleaners

Corrosion or short-circuit, damage to seals, to the hydraulic brake system, to the electrics and the seat



- Exercise restraint when using a steam jet or high-pressure cleaning equipment.◀

## Cleaning easily damaged components

### Plastics



#### ATTENTION

### Use of unsuitable cleaning agents

Damage to plastic surfaces

- Do not use cleaning agents that contain alcohol, solvents or abrasives.
- Do not use insect-remover pads or cleaning pads with hard, scouring surfaces.◀

### Body panels

Clean the trim panels with water and BMW plastic care emulsion.

### Windscreens and lenses made of plastic and metal cover on centre trim panel

Clean off dirt and insects with a soft sponge and plenty of water.



#### NOTICE

Soften stubborn dirt and insects by covering the affected areas with a wet cloth.◀



Clean with water and sponge only.



Do not use any chemical cleaning agents.

### Chrome

Use plenty of water and BMW shampoo to clean chrome, particularly if it has been exposed to road salt. Use chrome polish for additional treatment.

### Radiator

Clean the radiator regularly to prevent overheating of the engine due to inadequate cooling. For example, use a garden hose with low water pressure.



#### ATTENTION

### Bending of radiator fins

Damage to radiator fins

- Take care not to bend the radiator fins when cleaning.◀

### Rubber components

Treat rubber components with water or BMW rubber-care products.



#### ATTENTION

### Application of silicone sprays to rubber seals

Damage to the rubber seals

- Do not use silicone sprays or care products that contain silicon.◀

## Paint care

Washing the vehicle regularly will help counteract the long-term effects of substances that damage the paint, especially if your vehicle is ridden in areas with high air pollution or natural sources of dirt, for example tree resin or pollen.

Remove particularly aggressive substances immediately, however, as otherwise the paint can be affected or become discoloured. Substances of this nature include spilt fuel, oil, grease, brake fluid and bird droppings. We recommend BMW vehicle polish or BMW paint cleaner for this purpose.

Marks on the paintwork are particularly easy to see after the vehicle has been washed. Remove stains of this kind immediately, using cleaning-grade benzene or petroleum spirit on a clean cloth or ball of cotton.

BMW Motorrad recommends using BMW tar remover for removing specks of tar. Remember to wax the parts treated in this way.

## Protective wax coating

If water is no longer forming beads on the paint surface, it must be waxed.

BMW Motorrad recommends applying only BMW car wax or products containing carnauba wax or synthetic wax.

## Laying up the motorcycle

- Clean the motorcycle.
- Fill the motorcycle's fuel tank.
- Removing battery (▣▶ 154).
- Spray the brake and clutch lever pivots and the main and side stand pivots with a suitable lubricant.

- Coat bright metal and chrome-plated parts with an acid-free grease (e.g. Vaseline).
- Stand the motorcycle in a dry room in such a way that there is no load on either wheel (preferably using the front-wheel and rear-wheel stands from BMW Motorrad).

## Restoring motorcycle to use

- Remove the protective wax coating.
- Clean the motorcycle.
- Installing battery (▣▶ 155).
- Comply with checklist (▣▶ 90).

## Technical data

Troubleshooting chart .....	178
Threaded fasteners .....	179
Fuel.....	181
Engine oil .....	182
Engine .....	182
Clutch .....	183
Transmission .....	184
Final drive.....	184
Frame .....	185
Chassis and suspension .....	185
Brakes .....	186
Wheels and tyres .....	186
Electrical system.....	188
Anti-theft alarm .....	189
Dimensions .....	190

Weights.....	191
Riding specifications .....	191

## Troubleshooting chart

The engine does not start.

<b>Possible cause</b>	<b>Rectification</b>
Side stand extended and gear engaged	Retract the side stand.
Gear engaged and clutch not disengaged	Select neutral or pull the clutch lever.
No fuel in tank	Refuelling (▮▮▮▶ 98).
Battery flat	Charge battery when connected (▮▮▶ 153).
Overheating protection for starter motor has been activated. Starter motor can only be operated for a limited period of time.	Allow the starter motor to cool down for approx. 1 minute before using it again.

## Threaded fasteners

Front wheel	Value	Valid
<b>Brake caliper on telescopic fork</b>		
M10 x 65	38 Nm	
<b>Quick-release axle in telescopic forks</b>		
M20 x 1.5	50 Nm	
<b>Clamping screws in axle holder</b>		
M8 x 35	<b>Tighten screws six times in alternate sequence</b>	
	19 Nm	
<b>Rear wheel</b>	<b>Value</b>	<b>Valid</b>
<b>Rear wheel to wheel flange</b>		
M10 x 1.25 x 40	<b>Tighten in diagonally opposite sequence</b>	
	60 Nm	

<b>Mirror arm</b>	<b>Value</b>	<b>Valid</b>
<b>Mirror (locknut) to adapter</b>		
M10 x 1.25	Left-hand thread, 22 Nm	
<b>Adapter to clamping block</b>		
M10 x 14 - 4.8	25 Nm	
<b>Handlebars</b>	<b>Value</b>	<b>Valid</b>
<b>Clamping block (handlebar clamp) to fork bridge</b>		
M8 x 35	<b>In the forward direction of travel, tighten until seated</b>	
	19 Nm	
M8 x 30	<b>In the forward direction of travel, tighten until seated</b>	– with preparation for navigation system <sup>OE</sup>
	19 Nm	or – with preparation for navigation system <sup>OA</sup>

## Fuel

Recommended fuel grade	Super unleaded (max. 10 % ethanol, E10) 95 ROZ/RON 89 AKI
Alternative fuel grade	Regular unleaded (Power- and consumption-related restrictions. If e.g. the engine is to be operated in countries with low fuel grades at 91 research octane number, then the motorcycle must first be programmed appropriately at your authorised BMW motorcycle dealer.) 91 ROZ/RON 87 AKI
Usable fuel capacity	approx. 18 l
Reserve fuel	approx. 4 l

## Engine oil

Engine oil, capacity	max 4 l, with filter change
Specification	SAE 5W-40, API SL / JASO MA2, Additives (e.g. molybdenum-based) are not permissible because they can attack coated components of the engine, BMW Motorrad recommends BMW Motorrad ADVANTEC Ultimate oil.
Engine oil, quantity for topping up	max 0.95 l, Difference between MIN and MAX

**BMW recommends** **ADVANTEC**  
ORIGINAL BMW ENGINE OIL

## Engine

Location of engine number	Crankcase, bottom right, below starter motor
Engine type	122EN
Engine design	Air-/liquid-cooled two-cylinder four-stroke opposed-twin engine with two overhead spur-gear-driven camshafts and one balancing shaft
Displacement	1170 cm <sup>3</sup>
Cylinder bore	101 mm
Piston stroke	73 mm
Compression ratio	12.5:1



Nominal output	92 kW, at engine speed: 7750 min <sup>-1</sup>
– with power reduction <sup>OE</sup>	79 kW, at engine speed: 7750 min <sup>-1</sup>
Torque	125 Nm, at engine speed: 6500 min <sup>-1</sup>
– with power reduction <sup>OE</sup>	122 Nm, at engine speed: 5250 min <sup>-1</sup>
Maximum engine speed	max 9000 min <sup>-1</sup>
Idle speed	1150 min <sup>-1</sup> , Engine at regular operating temperature
Exhaust emissions standard	EU 4

## Clutch

Clutch type	Multiplate oil-bath clutch, anti-hopping
-------------	--

## Transmission

Gearbox type	Claw-shift 6-speed gearbox with helical gearing
Gearbox transmission ratios	1.000 (60:60 teeth), Primary transmission ratio 1.650 (33:20 teeth), Transmission input ratio 2.438 (39:16 teeth), 1st gear 1.714 (36:21 teeth), 2nd gear 1.296 (35:27 teeth), 3rd gear 1.059 (36:34 teeth), 4th gear 0.943 (33:35 teeth), 5th gear 0.848 (28:33 teeth), 6th gear 1.061 (35:33 teeth), Transmission output ratio

## Final drive

Type of final drive	Shaft drive with bevel gears
Type of rear suspension	Cast aluminium single swinging arm with BMW Motorrad paralever
Gear ratio of final drive	2.818 (31/11 teeth)

## Frame

Frame type	Tubular steel frame with supporting drive unit, steel pipe rear frames
Type plate location	Frame, front left, on steering head
Position of the Vehicle Identification Number	Frame, front right, on steering head

## Chassis and suspension

### Front wheel

Type of front suspension	Upside-down telescopic fork
Spring travel, front	140 mm, at front wheel

### Rear wheel

Type of rear suspension	Cast aluminium single swinging arm with BMW Motorrad paralever
Type of rear suspension	Central shock absorber complete with torsion spring, adjustable rebound-stage damping and spring preload
– With Dynamic ESA <sup>OE</sup>	Central spring strut with coil spring, electrically adjustable damping and spring preload
Spring travel at rear wheel	140 mm

## Brakes

### Front wheel

Type of front brake	Hydraulically operated twin disc brake with 4-piston radial brake calipers and floating brake discs
Brake-pad material, front	Sintered metal

### Rear wheel

Type of rear brake	Hydraulically actuated disc brake with 2-piston floating caliper and fixed disc
Brake-pad material, rear	Organic material

## Wheels and tyres

Recommended tyre sets	Your authorised BMW Motorrad dealer will be happy to supply an up-to-date list of the approved wheel/tyre combinations, or you can check the information posted on the <a href="http://bmw-motorrad.com">bmw-motorrad.com</a> website.
Speed category, front/rear tyres	W, required at least: 270 km/h

**Front wheel**

Front wheel type	Aluminium cast wheel
Front wheel rim size	3.5" x 17"
Tyre designation, front	120/70 - ZR 17
Load index, front tyre	min. 49
Permissible front-wheel imbalance	max 5 g

**Rear wheel**

Rear-wheel type	Aluminium cast wheel
Rear wheel rim size	5.5" x 17"
Tyre designation, rear	180/55 - ZR 17
Load index, rear tyre	min. 67
Permissible rear-wheel imbalance	max 45 g

**Tyre pressures**

Tyre pressure, front	2.5 bar, tyre cold
Tyre pressure, rear	2.9 bar, tyre cold

## Electrical system

Electrical rating of on-board sockets	max 5 A, total for all sockets
Fuse carrier 1	10 A, Slot 1: instrument cluster, alarm system (DWA), ignition lock, main relay, diagnostic socket 7.5 A, Slot 2: multifunction switch left, tyre pressure control (RDC), angular rate sensor
Fuse holder	50 A, Fuse 1: Voltage regulator
<b>Battery</b>	
Battery type	AGM (Absorbent Glass Mat) battery
Battery rated voltage	12 V
Battery rated capacity	12 Ah
<b>Spark plugs</b>	
Spark plugs, manufacturer and designation	NGK LMAR8D-J
Electrode gap of spark plug	0.8±0.1 mm, when new 1.0 mm, Wear limit
<b>Lighting</b>	
Bulb for high-beam headlight	H7 / 12 V / 55 W
Bulbs for the low-beam headlight	H7 / 12 V / 55 W
Bulb for parking light	W5W / 12 V / 5 W
– with Pro Headlight <sup>OE</sup>	LED

Bulb for tail light/brake light	LED
Bulbs for flashing turn indicators, front	RY10W / 12 V / 10 W
– with LED turn indicators <sup>OE</sup>	LED
Bulbs for flashing turn indicators, rear	RY10W / 12 V / 10 W
– with LED turn indicators <sup>OE</sup>	LED

## Anti-theft alarm

Activation time on arming	approx. 30 s
Alarm duration	approx. 26 s
Battery type	CR 123 A

## Dimensions

Length of motorcycle	2165 mm, measured over number-plate carrier
Height of motorcycle	1300 mm, measured across mirrors at DIN unladen weight
Width of motorcycle	880 mm, with mirrors
Front-seat height	790 mm, without rider at DIN unladen weight
– with front seat, low <sup>OE</sup>	760 mm, without rider at DIN unladen weight
– with front seat, high <sup>OE</sup>	820 mm, without rider at DIN unladen weight
Rider's inside-leg arc, heel to heel	1780 mm, without rider at unladen weight
– with front seat, low <sup>OE</sup>	1720 mm, without rider at unladen weight
– with front seat, high <sup>OE</sup>	1835 mm, without rider at unladen weight



## Weights

Vehicle kerb weight	232 kg, DIN unladen weight, ready for road 90 % load of fuel, without OE
Permissible gross weight	450 kg
Maximum payload	218 kg
Permissible wheel load, front	max 180 kg
Permissible wheel load, rear	max 300 kg

## Riding specifications

Starting capability on uphill gradients (at permissible gross weight)	20 %
Top speed	>200 km/h



## Service

BMW Motorrad Service .....	194
BMW Motorrad Mobility services .....	194
Maintenance work .....	194
Maintenance schedule .....	197
Confirmation of maintenance work .....	198
Confirmation of service .....	212

## BMW Motorrad Service

BMW Motorrad has an extensive network of dealerships in place to look after you and your motorcycle in more than 100 countries. Authorised BMW Motorrad dealerships have the technical information and the technical know-how to carry out reliably all maintenance and repair work on your BMW.

You can locate your nearest authorised BMW Motorrad dealership by visiting our website:

**[bmw-motorrad.com](http://bmw-motorrad.com)**



### WARNING

#### **Maintenance and repair work not in compliance with correct procedure**

Risk of accident due to consequential damage

- BMW Motorrad recommends having work of this nature carried out on the vehicle by a

specialist workshop, preferably an authorised BMW Motorrad dealer. ◀

In order to help ensure that your BMW is always in optimum condition, BMW Motorrad recommends compliance with the maintenance intervals specified for your motorcycle. Have all maintenance and repair work that is carried out confirmed in the "Service" chapter in this manual. For generous treatment of claims submitted after the warranty period has expired, evidence of regular maintenance is essential.

Your authorised BMW Motorrad dealer can provide information on BMW services and the work undertaken as part of each service.

## BMW Motorrad Mobility services

As owner of a new BMW vehicle, in circumstances in which assistance is required you can benefit from the protection afforded by the various BMW Motorrad mobility services (e.g. Mobile Service, breakdown service, vehicle recovery service). Your authorised BMW Motorrad dealer will be happy provide information about the mobility services available to you.

### Maintenance work

#### **BMW pre-delivery check**

Your authorised BMW Motorrad dealer conducts the BMW pre-delivery check before handing over the vehicle to you.

## BMW Running-in check



Running-in check

500...1200 km

## BMW Service

The BMW Service is carried out once a year; the extent of servicing can vary, depending on the age of the vehicle and the distance it has covered. Your authorised BMW Motorrad dealer confirms that the service work has been carried out and enters the date when the next service will be due.

Riders who cover long distances in a year might have to bring in their vehicles for service before the next scheduled date. It is to allow for these cases that a maximum odometer reading is entered as well in the confirmation of service. Servicing has to be brought forward if this odo-

meter reading is reached before the next scheduled date for the service.

The service-due indicator in the multifunction display reminds you about one month or 1000 km in advance when the time for a service is approaching, on the basis of the programmed values.

To find out more about service go to:

**[bmw-motorrad.com/service](http://bmw-motorrad.com/service)**

The maintenance tasks necessary for your vehicle are set out in the maintenance schedule below:



## Maintenance schedule

- 1** BMW Running-in check
- 2** BMW Service standard scope
- 3** Engine-oil change, with filter
- 4** Oil change in bevel gears rear
- 5** Check valve clearance
- 6** Replace all spark plugs
- 7** Replace air filter element
- 8** Oil change in the telescopic forks
- 9** Change brake fluid, entire system
  - a annually or every 10000 km (whichever comes first)
  - b every 2 years or every 20000 km (whichever comes first)
  - c for the first time after one year, then every two years

## Confirmation of maintenance work

### BMW Motorrad Service, standard scope

The activities in the BMW Motorrad Service standard scope are listed below. The actual scope of maintenance work for your vehicle may differ.

- Performing vehicle test with BMW Motorrad diagnostic system
- Visual inspection of hydraulic clutch system
- Visually inspecting brake pipes, brake hoses and connections
- Checking front brake pads and brake discs for wear
- Checking brake-fluid level, front brakes
- Checking rear brake pads and brake disc for wear
- Checking brake-fluid level, rear brakes
- Checking steering-head bearing
- Checking coolant level
- Checking ease of movement of side stand
- Checking tyre tread depth and tyre pressure
- Check the lights and signalling equipment
- Function test, engine start suppression
- Final inspection and check of roadworthiness
- Setting service-due date and service countdown distance
- Checking battery charge state
- Confirming the BMW service in the on-board literature



## BMW Pre-delivery Check

Completed

on \_\_\_\_\_

\_\_\_\_\_  
Stamp, signature

## BMW Running-in Check

Completed

on \_\_\_\_\_

Odometer reading \_\_\_\_\_

Next service

at the latest

on \_\_\_\_\_

or, if reached beforehand

Odometer reading \_\_\_\_\_

\_\_\_\_\_  
Stamp, signature

**BMW Service**

Completed

on \_\_\_\_\_

Odometer reading \_\_\_\_\_

Next service

at the latest

on \_\_\_\_\_

or, if reached beforehand

Odometer reading \_\_\_\_\_

Item

BMW Motorrad Service, standard  
scope

Yes

No

Oil change, engine, with filter

Oil change in rear bevel gears

Checking valve clearance

Renewing all spark plugs

Renewing air cleaner insert

Oil change in telescopic front forks

Change brake fluid in entire system

Notes

-----

-----

-----

-----

-----

-----

-----

-----

\_\_\_\_\_

Stamp, signature

**BMW Service**

Completed

on \_\_\_\_\_

Odometer reading \_\_\_\_\_

Next service

at the latest

on \_\_\_\_\_

or, if reached beforehand

Odometer reading \_\_\_\_\_

\_\_\_\_\_  
Stamp, signature

Item

BMW Motorrad Service, standard scope

Oil change, engine, with filter

Oil change in rear bevel gears

Checking valve clearance

Renewing all spark plugs

Renewing air cleaner insert

Oil change in telescopic front forks

Change brake fluid in entire system

Yes

No

Notes

-----

-----

-----

-----

-----

-----

-----

-----

**BMW Service**

Completed

on \_\_\_\_\_

Odometer reading \_\_\_\_\_

Next service

at the latest

on \_\_\_\_\_

or, if reached beforehand

Odometer reading \_\_\_\_\_

Item

BMW Motorrad Service, standard  
scope

Yes

No

Oil change, engine, with filter

Oil change in rear bevel gears

Checking valve clearance

Renewing all spark plugs

Renewing air cleaner insert

Oil change in telescopic front forks

Change brake fluid in entire system

Notes

-----

-----

-----

-----

-----

-----

-----

-----

 \_\_\_\_\_  
 Stamp, signature

**BMW Service**

Completed  
on \_\_\_\_\_  
Odometer reading \_\_\_\_\_

Next service  
at the latest  
on \_\_\_\_\_  
or, if reached beforehand  
Odometer reading \_\_\_\_\_

\_\_\_\_\_  
Stamp, signature

Item	Yes	No
BMW Motorrad Service, standard scope	<input type="checkbox"/>	<input type="checkbox"/>
Oil change, engine, with filter	<input type="checkbox"/>	<input type="checkbox"/>
Oil change in rear bevel gears	<input type="checkbox"/>	<input type="checkbox"/>
Checking valve clearance	<input type="checkbox"/>	<input type="checkbox"/>
Renewing all spark plugs	<input type="checkbox"/>	<input type="checkbox"/>
Renewing air cleaner insert	<input type="checkbox"/>	<input type="checkbox"/>
Oil change in telescopic front forks	<input type="checkbox"/>	<input type="checkbox"/>
Change brake fluid in entire system	<input type="checkbox"/>	<input type="checkbox"/>

Notes  
-----  
-----  
-----  
-----  
-----  
-----  
-----  
-----

**BMW Service**

Completed

on \_\_\_\_\_

Odometer reading \_\_\_\_\_

Next service

at the latest

on \_\_\_\_\_

or, if reached beforehand

Odometer reading \_\_\_\_\_

Item

BMW Motorrad Service, standard  
scope

Yes

No

Oil change, engine, with filter

Oil change in rear bevel gears

Checking valve clearance

Renewing all spark plugs

Renewing air cleaner insert

Oil change in telescopic front forks

Change brake fluid in entire system

Notes

-----

-----

-----

-----

-----

-----

-----

-----

\_\_\_\_\_

Stamp, signature

**BMW Service**

Completed

on \_\_\_\_\_

Odometer reading \_\_\_\_\_

Next service

at the latest

on \_\_\_\_\_

or, if reached beforehand

Odometer reading \_\_\_\_\_

\_\_\_\_\_  
Stamp, signature

Item

Yes      No

BMW Motorrad Service, standard scope

Oil change, engine, with filter

Oil change in rear bevel gears

Checking valve clearance

Renewing all spark plugs

Renewing air cleaner insert

Oil change in telescopic front forks

Change brake fluid in entire system

Notes

-----  
-----  
-----  
-----  
-----  
-----  
-----  
-----

**BMW Service**

Completed

on \_\_\_\_\_

Odometer reading \_\_\_\_\_

Next service

at the latest

on \_\_\_\_\_

or, if reached beforehand

Odometer reading \_\_\_\_\_

Item

BMW Motorrad Service, standard  
scope

Yes

No

Oil change, engine, with filter

Oil change in rear bevel gears

Checking valve clearance

Renewing all spark plugs

Renewing air cleaner insert

Oil change in telescopic front forks

Change brake fluid in entire system

Notes

-----

-----

-----

-----

-----

-----

-----

-----

\_\_\_\_\_

Stamp, signature



**BMW Service**

Completed  
on \_\_\_\_\_  
Odometer reading \_\_\_\_\_

Next service  
at the latest  
on \_\_\_\_\_  
or, if reached beforehand  
Odometer reading \_\_\_\_\_

\_\_\_\_\_  
Stamp, signature

Item	Yes	No
BMW Motorrad Service, standard scope	<input type="checkbox"/>	<input type="checkbox"/>
Oil change, engine, with filter	<input type="checkbox"/>	<input type="checkbox"/>
Oil change in rear bevel gears	<input type="checkbox"/>	<input type="checkbox"/>
Checking valve clearance	<input type="checkbox"/>	<input type="checkbox"/>
Renewing all spark plugs	<input type="checkbox"/>	<input type="checkbox"/>
Renewing air cleaner insert	<input type="checkbox"/>	<input type="checkbox"/>
Oil change in telescopic front forks	<input type="checkbox"/>	<input type="checkbox"/>
Change brake fluid in entire system	<input type="checkbox"/>	<input type="checkbox"/>

Notes  
-----  
-----  
-----  
-----  
-----  
-----  
-----  
-----

**BMW Service**

Completed

on \_\_\_\_\_

Odometer reading \_\_\_\_\_

Next service

at the latest

on \_\_\_\_\_

or, if reached beforehand

Odometer reading \_\_\_\_\_

Item

BMW Motorrad Service, standard  
scope

Yes

No

Oil change, engine, with filter

Oil change in rear bevel gears

Checking valve clearance

Renewing all spark plugs

Renewing air cleaner insert

Oil change in telescopic front forks

Change brake fluid in entire system

Notes

-----

-----

-----

-----

-----

-----

-----

-----

\_\_\_\_\_

Stamp, signature

**BMW Service**

Completed

on \_\_\_\_\_

Odometer reading \_\_\_\_\_

Next service

at the latest

on \_\_\_\_\_

or, if reached beforehand

Odometer reading \_\_\_\_\_

Item

Yes

No

BMW Motorrad Service, standard  
scope

Oil change, engine, with filter

Oil change in rear bevel gears

Checking valve clearance

Renewing all spark plugs

Renewing air cleaner insert

Oil change in telescopic front forks

Change brake fluid in entire system

Notes

-----

-----

-----

-----

-----

-----

-----

-----

-----

\_\_\_\_\_

Stamp, signature

**BMW Service**

Completed

on \_\_\_\_\_

Odometer reading \_\_\_\_\_

Next service

at the latest

on \_\_\_\_\_

or, if reached beforehand

Odometer reading \_\_\_\_\_

Item

BMW Motorrad Service, standard  
scope

Yes

No

Oil change, engine, with filter

Oil change in rear bevel gears

Checking valve clearance

Renewing all spark plugs

Renewing air cleaner insert

Oil change in telescopic front forks

Change brake fluid in entire system

Notes

-----

-----

-----

-----

-----

-----

-----

-----

\_\_\_\_\_

Stamp, signature

**BMW Service**

Completed

on \_\_\_\_\_

Odometer reading \_\_\_\_\_

Next service

at the latest

on \_\_\_\_\_

or, if reached beforehand

Odometer reading \_\_\_\_\_

\_\_\_\_\_  
Stamp, signature

Item

BMW Motorrad Service, standard scope

Oil change, engine, with filter

Oil change in rear bevel gears

Checking valve clearance

Renewing all spark plugs

Renewing air cleaner insert

Oil change in telescopic front forks

Change brake fluid in entire system

Yes

No

Notes

-----

-----

-----

-----

-----

-----

-----

-----

## Confirmation of service

The table is intended as a record of maintenance and repair work, the installation of optional accessories and, if appropriate, special campaign (recall) work.

Item	Odometer reading	Date

Item	Odometer reading	Date





## Appendix

Certificate for electronic immobiliser .....	216
Certificate for Keyless Ride .....	218
Certificate for tyre pressure control (RDC) .....	220

## FCC Approval

### Ring aerial in the ignition switch



To verify the authorization of the ignition key, the electronic immobilizer exchanges information with the ignition key via the ring aerial.

This device complies with Part 15 of the FCC rules. Operation is subject to the following two conditions:

- (1) This device may not cause harmful interference, and
- (2) this device must accept any interference received, including interference that may cause undesired operation.



Any changes or modifications not expressly approved by the party responsible for compliance could void the user's authority to operate the equipment. ◀

## Approbation de la FCC

### Antenne annulaire présente dans le commutateur d'allumage



Pour vérifier l'autorisation de la clé de contact, le système d'immobilisation électronique échange des

informations avec la clé de contact via l'antenne annulaire.

Le présent dispositif est conforme à la partie 15 des règles de la FCC. Son utilisation est soumise aux deux conditions suivantes :

- (1) Le dispositif ne doit pas produire d'interférences nuisibles, et
- (2) le dispositif doit pouvoir accepter toutes les interférences extérieures, y compris celles qui pourraient provoquer une activation inopportune.



Toute modification qui n'aurait pas été approuvée expressément par l'organisme responsable de l'homologation peut annuler l'autorisation accordée à l'utilisateur pour utiliser le dispositif. ◀

## Certifications

---

### BMW Keyless Ride ID Device



#### USA, Canada

Product name: BMW Keyless Ride ID Device  
FCC ID: YGOHUF5750  
IC: 4008C-HUF5750

#### Canada:

Operation is subject to the following two conditions:

- (1) This device may not cause harmful interference, and
- (2) this device must accept any interference received, including interference that may cause undesired operation.

#### USA:

This device complies with Part 15 of the FCC rules. Operation is subject to the following two conditions:

- (1) This device may not cause harmful interference, and
- (2) this device must accept any interference received, including interference that may cause undesired operation.



Any changes or modifications not expressly approved by the party responsible for compliance could void the user's authority to operate the equipment.

# Declaration Of Conformity

---

We declare under our responsibility that the product

## **BMW Keyless Ride ID Device (Model: HUF5750)**

complies with the appropriate essential requirements of the article 3 of the R&TIE and the other relevant provisions, when used for its intended purpose. Applied Standards:

1. Health and safety requirements contained in article 3 (1) a)
  - EN 60950-1:2006+A11:2009+A1:2010+A12:2011; Information technology equipment- Safety
2. Protection requirements with respect to electromagnetic compatibility article 3 (1) b)
  - EN 301 489-1 (V1 .9.2, 09/2011 ), Electromagnetic compatibility and radio spectrum matters (ERM); Electromagnetic compatibility (EMC) standard for radio equipment and services; Part 1: Common technical requirements
  - EN 301 489-3 (V1.4.1, 08/2002) Electromagnetic compatibility and radio spectrum matters (ERM); Electromagnetic compatibility (EMC) standard for radio equipment and services; Part 3: Specific conditions for short range devices (SRD) operating on frequencies between 9 kHz and 40 GHz
3. Means of the efficient use of the radio frequency spectrum article 3 (2)
  - EN 300 220-1 & -2 (V2.4.1, 05/2012), electromagnetic compatibility and radio spectrum matters (ERM); Short range devices (SRD); Radio equipment to be used in the 25 MHz to 1000 MHz frequency range with power levels ranging up to 500 mW;  
Part 1: Technical characteristics and test methods.  
Part 2: Harmonized EN covering essential requirements under article 3.2 of the R&TIE directive

The product is labeled with the CE marking: **CE**

Velbert, October 15<sup>th</sup>, 2013

---

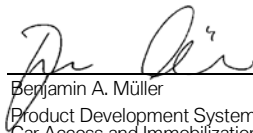

---

Benjamin A. Müller  
Product Development Systems  
Car Access and Immobilization – Electronics  
Huf Hüsbeck & Fürst GmbH & Co. KG  
Steeger Straße 17, D-42551 Velbert

## Certification Tire Pressure Control (TPC)

---

FCC ID: MRXBC54MA4  
IC: 2546A-BC54MA4

FCC ID: MRXBC5A4  
IC: 2546A-BC5A4

This device complies with Part 15 of the FCC Rules and with Industry Canada license-exempt RSS standard(s).

Operation is subject to the following two conditions:

- (1) This device may not cause harmful interference, and
- (2) This device must accept any interference received, including interference that may cause undesired operation.

Le présent appareil est conforme aux CNR d'Industrie Canada applicables aux appareils radio exempts de licence. L'exploitation est autorisée aux deux conditions suivantes:

- (1) l'appareil ne doit pas produire de brouillage, et
- (2) l'utilisateur de l'appareil doit accepter tout brouillage radioélectrique subi, même si le brouillage est susceptible d'en compromettre le fonctionnement.

**WARNING:** Changes or modifications not expressly approved by the party responsible for compliance could void the user's authority to operate the equipment. The term "IC:" before the radio certification number only signifies that Industry Canada technical specifications were met.

**A**

Abbreviations and symbols, 6

**ABS**

Control, 15

Engineering details, 106

Indicator and warning lights, 40  
operate, 69

Self-diagnosis, 92

**Accessories**

General instructions, 160

**Actuality, 7****Air filter**

Position on the motorcycle, 13

**Ambient temperature**

Outside temperature  
warning, 31

Reading, 44

**Anti-theft alarm**

Indicator light, 18

operate, 67

Warning, 39

**ASC**

Control, 15

Engineering details, 109

operate, 71

Self-diagnosis, 93

**Average values**

Resetting, 62

**B****Battery**

Charging battery when  
connected, 153

Charging battery when  
disconnected, 153

Indicator light for battery  
charge voltage, 38

Installation, 155

Maintenance instructions, 152

Removal, 154

Technical data, 188

Warning for battery voltage  
low, 38

**Brake fluid**

Checking fluid level, front, 126

Checking fluid level, rear, 127

Reservoir, front, 13

Reservoir, rear, 13

**Brake pads**

Checking front, 124

Checking rear, 125

Running in, 94

**Brakes**

ABS Pro in detail, 108

ABS Pro depending on riding  
mode, 96

Adjusting handlebar lever, 84

Checking function, 124

Safety instructions, 95

Technical data, 186

**C**

Cases, 161

Checklist, 90

**Clock**

adjusting, 64

**Clutch**

Adjusting handlebar lever, 83

Checking operation, 128

Technical data, 183

Confirmation of maintenance

work, 198

- Coolant
  - Checking fill level, 128
  - Warning for overtemperature, 32
- Cruise-control system
  - operate, 76
- D**
- Damping
  - Adjuster, rear, 11
  - Adjusting, 85
- Daytime riding lights
  - automatic daytime riding light, 58
  - Manual daytime riding light, 57
  - Position on the vehicle, 11
- Diagnostic connector
  - Loosen, 157
  - secure, 158
- Dimensions
  - Technical data, 190
- DTC
  - Engineering details, 110
- DWA
  - Technical data, 189
- E**
- Electrics
  - Technical data, 188
- Emergency off switch (kill switch), 17
  - Operation, 55
- Emissions warning light, 34
- Engine
  - Indicator light for engine control unit, 33
  - Malfunction indicator lamp, 34
    - starting, 91
  - Technical data, 182
  - Warning light for engine electronics, 33
- Engine oil
  - Checking fill level, 122
  - Filling level indicator, 13
  - Oil filler opening, 13
  - Oil level, 43
  - Technical data, 182
  - Topping up, 123
  - Warning for engine oil level, 34
- Engine temperature
  - Warning for overtemperature, 32
- Equipment, 7
- ESA
  - Control, 15
  - Engineering details, 112
  - operate, 72
- F**
- Frame
  - Technical data, 185
- Front-wheel stand
  - Installing, 120
- Fuel
  - Fuel grade, 98
  - Oil filler opening, 11
  - refuelling, 98, 100
  - Refuelling, 98, 100
  - refuelling with Keyless Ride, 100, 101
  - Reserve volume, 43
  - Technical data, 181
- Fuel reserve
  - Warning, 42



- Fuses
  - replacing, 156
  - Technical data, 188

## **G**

- General views
  - Indicator and warning lights, 20
  - Instrument panel, 18
  - Left multifunction switch, 15
  - Left side of vehicle, 11
  - Multifunction display, 22, 23, 24
  - Right multifunction switch, 17
  - Right side of vehicle, 13
  - Underneath the seat, 14

## **H**

- Hazard warning flashers
  - Control, 15, 17
  - operate, 59
- Headlight
  - Beam throw, 82
  - Headlight beam-throw adjustment, 11
- Headlight courtesy delay feature, 48, 56

- Heated handlebar grips
  - Control, 17
  - operate, 78
- Horn, 15

## **I**

- Ignition
  - Switching off, 49
  - Switching on, 48
- Immobiliser
  - Emergency key, 52
  - Reserve key, 49
  - Warning, 31
- Instrument panel
  - Ambient-light brightness sensor, 18
  - Overview, 18

## **J**

- Jump-start, 151

## **K**

- Keyless Ride
  - Battery of radio-operated key flat, 53
  - Electronic immobiliser EWS, 52

- Fuel filler cap, unlocking, 100, 101
- Lock the handlebars, 50
- Loss of the radio-operated key, 53
- Switching off ignition, 51
- Switching on ignition, 51
- Warning, 31, 32
- Keys, 48, 50

## **L**

- Lighting
  - High-beam headlight, 139
  - LED auxiliary headlights, 150
  - LED daytime riding light, 150
  - Low-beam headlight, 139
  - Number-plate light, 148
  - Replacing LED rear light, 150
  - Side light, 143
  - Technical data, 188
  - Turn indicators, 147
  - Warning for defective bulb, 37

**Lights**

- automatic daytime riding light, 58
  - Control, 15
  - Headlight courtesy delay feature, 56
  - Headlight flasher, operating, 56
  - High-beam headlight, operating, 56
  - Low-beam headlight, 55
  - Manual daytime riding light, 57
  - Operating LED auxiliary headlights, 56
  - Parking lights, 56
  - Side light, 55
- Luggage**
- Instructions for loading, 88

**M****Maintenance**

- General instructions, 120
- Maintenance schedule, 197
- Maintenance intervals, 194

**Mirrors**

- Adjusting, 82
- Mobility services, 194

**Motorcycle**

- care, 173
  - cleaning, 173
  - Lashing, 102
  - Laying up, 176
  - parking, 97
  - restoring to use, 176
- Multifunction display, 18**
- Control, 15
  - Operation, 61
  - Overview, 22, 23, 24
  - Select display, 60
  - Selecting multifunction display view, 60
- Multifunction switch**
- General view, left side , 15
  - General view, right side, 17

**O**

- Odometer and tripmeters**
- reset, 62

**P**

- Parking, 97**
- Parking light, 56
- Power socket**
- Notes on use, 160
  - Position on the vehicle, 13
- Pre-Ride-Check, 91**

**R****RDC**

- Adhesive label for rim, 131
  - Engineering details, 114
- Rear-wheel drive**
- Technical data, 184
- Rear-wheel stand**
- Installing, 122
- Refuelling, 98, 100**
- with Keyless Ride, 100, 101
- Remote control**
- Replacing battery, 54
- Rev. counter, 18**
- Rider's Manual**
- Position on the vehicle, 14

Riding mode  
  Adjusting, 73  
  Control, 17  
  Engineering details, 113  
Running gear  
  Technical data, 185  
Running in, 93

## **S**

Safety instructions  
  for brakes, 95  
  for riding, 88  
Seat  
  Position of the height  
  adjustment, 14  
Seats  
  Lock, 11  
  Removing and installing, 79  
Service, 194  
  Warning, 39  
Service-due indicator, 42  
Shift assistant, 94  
  Gear not calibrated, 41  
Shifting gear  
  Recommendation to upshift, 45

Silencer  
  Securing silencer, 138  
  Silencer, swivelling, 138

Spark plugs  
  Technical data, 188

Speedometer, 18

Spring preload  
  Adjuster, rear, 13  
  Adjusting, 84

Starting, 91  
  Control, 17

Steering lock  
  Locking, 48

## **T**

Technical data  
  Anti-theft alarm, 189  
  Battery, 188  
  Brakes, 186  
  Chassis and suspension, 185  
  Clutch, 183  
  Dimensions, 190  
  Electrical system, 188  
  Engine, 182  
  Engine oil, 182

Final drive, 184  
Frame, 185  
Fuel, 181  
Lighting, 188  
Spark plugs, 188  
Standards, 7  
Transmission, 184  
Weights, 191  
Wheels and tyres, 186  
Telltale lights, 18  
  Overview, 20  
Toolkit  
  Contents, 120  
  Position on the vehicle, 14  
Topcase  
  Operation, 164  
Torques, 179  
Transmission  
  Technical data, 184  
Troubleshooting chart, 178  
Turn indicators  
  Control, 15  
  operate, 60  
Type plate  
  Position on the vehicle, 13

Tyre pressure monitoring RDC  
Reading, 44

## Tyres

- Checking inflation pressure, 129
- Checking tread depth, 130
- Pressures, 187
- Recommendation, 130
- Running in, 94
- Table of tyre pressures, 14
- Technical data, 186
- Top speed, 89

## V

Vehicle Identification Number  
Position on the vehicle, 13

## W

Warning lights, 18  
Overview, 20

## Warnings

- ABS, 40
- Anti-theft alarm, 39
- Battery charge voltage, 38
- Bulb faulty, 37
- Coolant temperature, 32

- Engine control unit, 33
- Engine electronics, 33
- Engine oil level, 34
- Engine temperature, 32
- Engine temperature, 32
- Fuel reserve, 42
- Gear not calibrated, 41
- Immobiliser, 31
- Malfunction indicator lamp, 34
- Mode of presentation, 25
- Outside temperature warning, 31
- Service, 39
- Undervoltage, 38

Warnings, overview, 26

## Weights

- Payload table, 14
- Technical data, 191

## Wheels

- Change of size, 131
- Checking rims, 130
- Installing front wheel, 134
- Installing the rear wheel, 137
- Removing front wheel, 132
- Technical data, 186



Details described or illustrated in this booklet may differ from the vehicle's actual specification as purchased, the accessories fitted or the national-market specification. No claims will be entertained as a result of such discrepancies.

Dimensions, weights, fuel consumption and performance data are quoted to the customary tolerances.

The right to modify designs, equipment and accessories is reserved.

Errors and omissions excepted.

© 2016 Bayerische Motoren Werke Aktiengesellschaft  
80788 Munich, Germany  
Not to be reproduced by any means whatsoever, wholly or in part, without the written permission of BMW Motorrad, After Sales.

Original rider's manual, printed in Germany.

## Important data for refuelling:

<b>Fuel</b>	
Recommended fuel grade	Super unleaded (max. 10 % ethanol, E10) 95 ROZ/RON 89 AKI
Alternative fuel grade	Regular unleaded (Power- and consumption-related restrictions. If e.g. the engine is to be operated in countries with low fuel grades at 91 research octane number, then the motorcycle must first be programmed appropriately at your authorised BMW motorcycle dealer.) 91 ROZ/RON 87 AKI
Usable fuel capacity	approx. 18 l
Reserve fuel	approx. 4 l
<b>Tyre pressures</b>	
Tyre pressure, front	2.5 bar, tyre cold
Tyre pressure, rear	2.9 bar, tyre cold

For further information on all aspects of your motorcycle, visit [bmw-motorrad.com](http://bmw-motorrad.com)

**BMW recommends** **ADVANTEC**  
ORIGINAL BMW ENGINE OIL

Order No.: 01 40 8 357 901  
04.2016, 4th edition, 01

