



BMW Motorrad



The Ultimate  
Riding Machine

# Rider's Manual R 1200 GS

## Vehicle data/dealership details

### Vehicle data

---

Model

---

Vehicle Identification Number

---

Colour code

---

Date of first registration

---

Registration number

### Dealership details

---

Person to contact in Service department

---

Ms/Mr

---

Phone number

---

Dealership address/phone number (company stamp)

## **Welcome to BMW**

We congratulate you on your choice of a vehicle from BMW Motorrad and welcome you to the community of BMW riders. Familiarise yourself with your new vehicle so that you can ride it safely and confidently in all traffic situations.

### **About this Rider's Manual**

Please read this Rider's Manual carefully before starting to use your new BMW. It contains important information on how to operate the controls and how to make the best possible use of all your BMW's technical features. In addition, it contains information on maintenance and care to help you maintain your vehicle's reliability and safety, as well as its value.

### **Suggestions and criticism**

If you have questions concerning your motorcycle, your authorised BMW Motorrad dealer will gladly provide advice and assistance.

We hope you will enjoy riding your BMW and that all your journeys will be pleasant and safe

BMW Motorrad.

01 41 8 563 201



# Table of Contents

<b>1 General instructions .... 5</b>	Ambient temperature..... 39	Riding mode ..... 67
Overview ..... 6	Fuel reserve ..... 40	Cruise-control system ..... 71
Abbreviations and symbols ..... 6	Oil level ..... 40	Spring preload ..... 73
Equipment ..... 7	Service-due indicator..... 41	Damping ..... 74
Technical data ..... 7	Tyre pressure ..... 41	Dynamic ESA, electronic suspension adjustment..... 75
Actuality..... 7	Recommendation to up-shift ..... 42	Clutch ..... 77
<b>2 General views ..... 9</b>	<b>4 Operation..... 43</b>	Brakes ..... 78
General view, left side ..... 11	Ignition ..... 44	Tyres..... 78
General view, right side ..... 13	Ignition with Key-less Ride ..... 46	Handlebars ..... 79
Underneath the seat ..... 14	Multifunction display ..... 51	Heated handlebar grips ..... 79
Multifunction switch, left .... 15	Anti-theft alarm (DWA) ..... 57	Mirrors ..... 80
Multifunction switch, right ..... 17	Emergency off switch (kill switch) ..... 59	Windscreen ..... 80
Instrument panel ..... 18	Headlight..... 60	Front and rear seats..... 81
<b>3 Status indicators ..... 19</b>	Lights ..... 61	<b>5 Riding..... 85</b>
Warning and telltale lights ..... 20	Daytime riding light..... 62	Safety instructions ..... 86
Multifunction display ..... 22	Turn indicators ..... 64	Comply with checklist ..... 89
Warning symbols in the display ..... 24	Hazard warning flashers ..... 65	Starting..... 89
Warnings ..... 25	BMW Motorrad Integral ABS..... 65	Running in ..... 91
	Automatic Stability Control ASC..... 66	Shifting gear ..... 92
		Brakes ..... 93
		Parking your motorcycle .... 95
		Off-roading ..... 96
		Refuelling ..... 97

Securing motorcycle for transportation .....	101	Air filter .....	138	Fuel .....	172
<b>6 Engineering details .....</b>	<b>103</b>	Jump-starting .....	140	Engine oil .....	173
Riding mode .....	104	Battery .....	141	Clutch .....	173
Shift assistant .....	105	Fuses .....	145	Transmission .....	174
Brake system with BMW Motorrad Integral ABS .....	106	<b>8 Accessories .....</b>	<b>147</b>	Rear-wheel drive .....	174
Electronic engine management with BMW Motorrad ASC .....	110	General instructions .....	148	Running gear .....	175
Tyre pressure monitoring RDC .....	112	Power sockets .....	148	Brakes .....	176
<b>7 Maintenance .....</b>	<b>115</b>	Navigation system .....	149	Wheels and tyres .....	177
General instructions .....	116	Cases .....	154	Electrics .....	179
Toolkit .....	116	Topcase .....	157	Frame .....	180
Engine oil .....	117	<b>9 Care .....</b>	<b>161</b>	Anti-theft alarm .....	181
Brake system .....	118	Care products .....	162	Dimensions .....	181
Coolant .....	122	Washing the vehicle .....	162	Weights .....	182
Clutch .....	124	Cleaning easily damaged components .....	163	Riding specifications .....	182
Rims and tyres .....	124	Paint care .....	164	<b>11 Service .....</b>	<b>183</b>
Wheels .....	125	Laying up the motorcycle .....	164	BMW Motorrad Service ...	184
Front-wheel stand .....	132	Protective wax coating ...	164	BMW Motorrad Mobility services .....	184
Lighting .....	133	Restoring motorcycle to use .....	165	Maintenance work .....	184
		<b>10 Technical data .....</b>	<b>167</b>	Maintenance schedule ...	187
		Troubleshooting chart .....	168	Standard BMW service ...	188
		Threaded fasteners .....	169	Confirmation of maintenance work .....	189
		Engine .....	171	Confirmation of service ...	194

<b>12 Appendix</b> .....	<b>197</b>
Certificate for electronic immobiliser .....	198
Certificate for Keyless Ride .....	200
Certificate for tyre pressure monitoring (Reifendruck-Control, RDC) .....	202
<b>13 Index</b> .....	<b>203</b>

## General instructions

Overview .....	6
Abbreviations and symbols .....	6
Equipment .....	7
Technical data .....	7
Actuality .....	7

## Overview

An important aspect of this Rider's Manual is that it can be used for quick and easy reference. Consulting the extensive index at the end of this Rider's Manual is the fastest way to find information on a particular topic or item. To first read an overview of your motorcycle, please go to Chapter 2. All maintenance and servicing work on the vehicle is documented in Chapter 11. This record of the maintenance work you have had performed on your vehicle is a precondition for generous treatment of goodwill claims. When the time comes to sell your BMW, please remember to hand over this Rider's Manual; it is an important part of the motorcycle.

## Abbreviations and symbols



**CAUTION** Low-risk hazard. Non-avoidance can lead to slight or moderate injury.



**WARNING** Medium-risk hazard. Non-avoidance can lead to fatal or severe injury.



**DANGER** High-risk hazard. Non-avoidance leads to fatal or severe injury.





**ATTENTION** Special notes and precautionary measures. Non-compliance can lead to damage to the vehicle or accessory and, consequently, to voiding of the warranty.



**NOTICE** Specific instructions on how to operate, control, adjust or look after items of equipment on the vehicle.



Indicates the end of an item of information.

- Instruction.
- » Result of an activity.
- ➔ Reference to a page with more detailed information.
- ◁ Indicates the end of a passage relating to specific accessories or items of equipment.
-  Tightening torque.
-  Technical data.
- OE Optional extras. The vehicles are assembled complete with all the BMW Motorrad optional extras originally ordered.



- OA Optional accessories. You can obtain BMW Motorrad optional accessories through your authorised BMW Motorrad dealer; optional accessories have to be retrofitted to the vehicle.
- EWS Electronic immobiliser.
- DWA Anti-theft alarm (Diebstahlwarnanlage).
- ABS Anti-lock brake system.
- ASC Automatic Stability Control.
- ESA Electronic Suspension Adjustment.
- RDC Tyre pressure monitoring.

## Equipment

When you purchased your BMW motorcycle, you chose a model with individual equipment. This Rider's Manual describes the optional extras (OE) offered by BMW and selected optional accessories (OA). This explains why the manual may also contain descriptions of equipment which you have not ordered. Please note, too, that your motorcycle might not be exactly as illustrated in this manual on account of country-specific differences. If your motorcycle contains equipment that has not been described, its description can be found in a separate manual.

## Technical data

All dimensions, weights and power ratings stated in the Rider's Manual are quoted to the standards and comply with the

tolerance requirements of the Deutsches Institut für Normung e.V. (DIN). Versions for individual countries may differ.

## Actuality

The high safety and quality level of BMW motorcycles is ensured by continuous development work on design, equipment and accessories. Because of this, your motorcycle may differ from the information supplied in the Rider's Manual. Nor can BMW Motorrad entirely rule out errors and omissions. Consequently no claims can be derived from the information, graphics or descriptions.





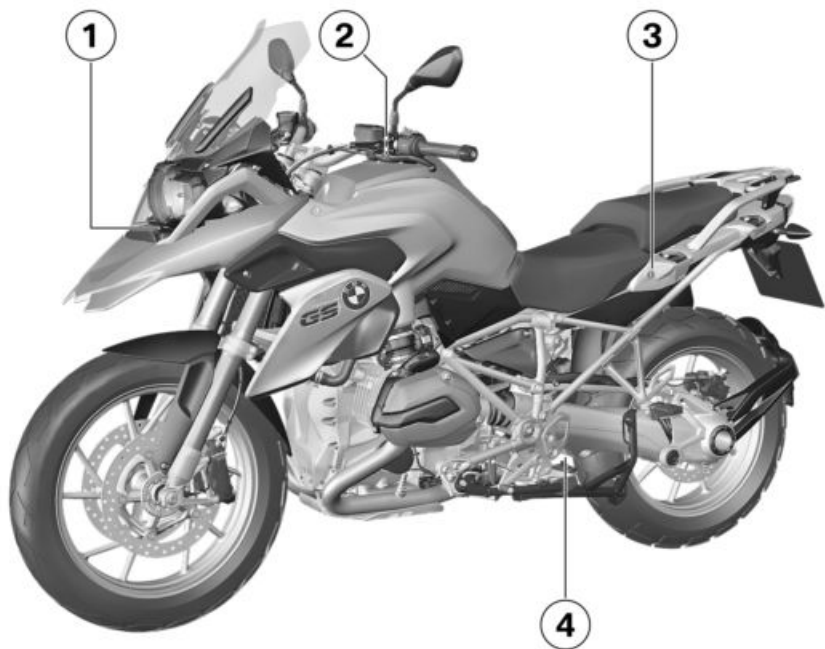

## General views

General view, left side.....	11
General view, right side .....	13
Underneath the seat .....	14
Multifunction switch, left .....	15
Multifunction switch, right.....	17
Instrument panel .....	18



## General view, left side

- 1 – with daytime running  
light<sup>OE</sup>  
Daytime riding lights  
( 62)
- 2 Fuel filler neck ( 98)
- 3 Seat lock ( 81)
- 4 Setting the rear damping  
(down at the spring strut)  
( 74)

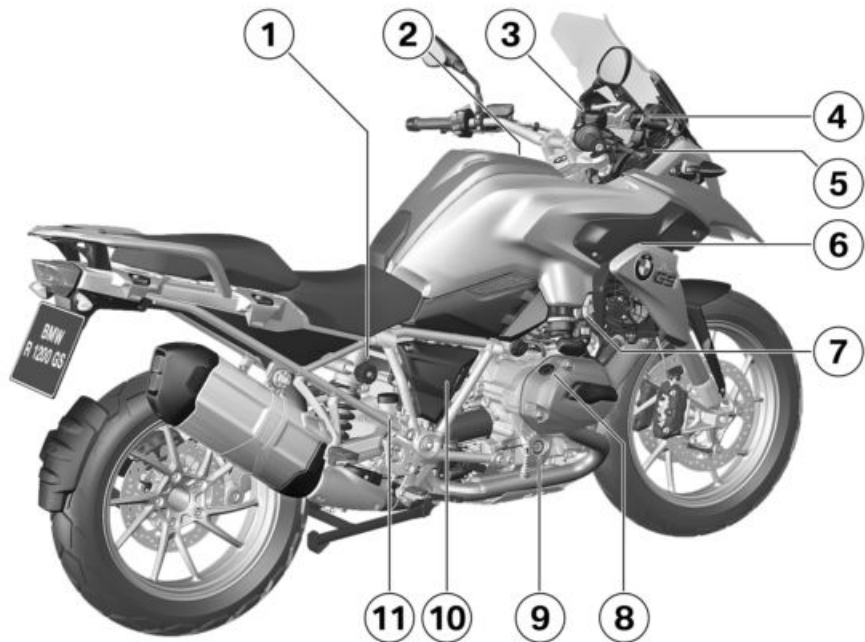

## General view, right side

- 1 Adjuster for spring preload, rear (▣▣▣▣ 73)
- 2 Air filter (underneath the centre trim panel) (▣▣▣▣ 138)
- 3 Brake-fluid reservoir, front (▣▣▣▣ 120)
- 4 Height adjustment of the windscreen (▣▣▣▣ 80)
- 5 Power socket (▣▣▣▣ 148)
- 6 VIN (on steering-head bearing)  
Type plate (on the frame, front right)
- 7 Coolant-level indicator (▣▣▣▣ 122)  
Coolant reservoir (▣▣▣▣ 123)
- 8 Oil filler neck (▣▣▣▣ 118)
- 9 Engine oil level indicator (▣▣▣▣ 117)
- 10 Battery (behind the side trim panel) (▣▣▣▣ 141)  
Battery support point (behind the side trim panel) (▣▣▣▣ 140)
- 11 Brake-fluid reservoir, rear (▣▣▣▣ 121)

## Underneath the seat

- 1 Standard toolkit (➔ 116)
- 2 Rider's Manual
- 3 Table of tyre pressures
- 4 Payload table
- 5 Adjusting the front seat height (➔ 82)
- 6 Fuses (➔ 145)

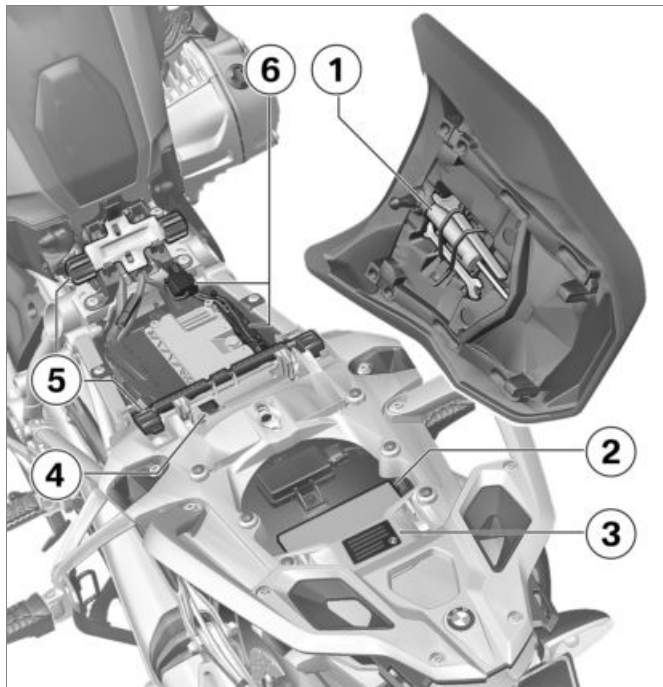



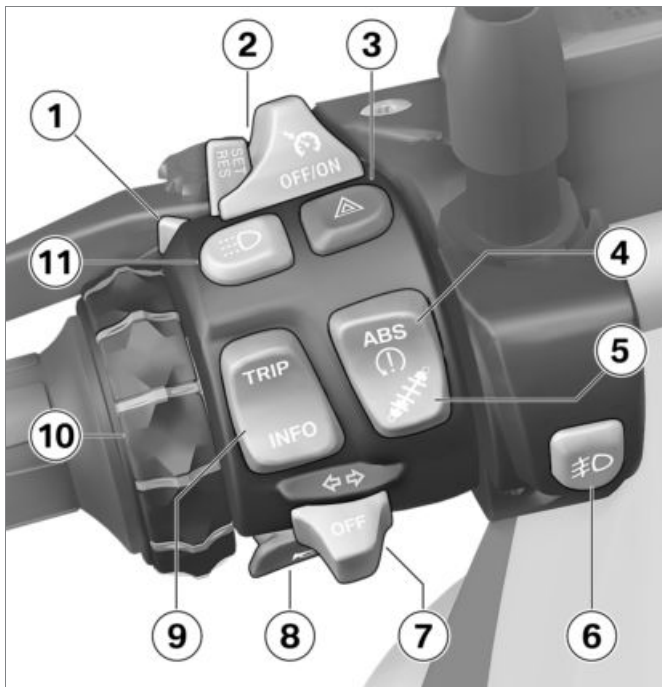

## Multifunction switch, left

- 1 High-beam headlight and headlight flasher (➡ 61)
- 2 – with cruise control<sup>OE</sup>  
Cruise-control system (➡ 71)
- 3 Hazard warning flashers (➡ 65)
- 4 ABS (➡ 65)  
ASC (➡ 66)
- 5 – with Dynamic ESA<sup>OE</sup>  
ESA (➡ 75)
- 6 – with LED auxiliary head-  
lights<sup>OA</sup>  
LED auxiliary headlights (➡ 62)
- 7 Turn indicators (➡ 64)
- 8 Horn
- 9 Multifunction display (➡ 51)

- 10** – with preparation for navigation system<sup>OE</sup>

Navigation system

( 151)

- 11** – with daytime running light<sup>OE</sup>

Daytime riding lights

( 62)



## Multifunction switch, right

- 1 – with heated handlebar grips<sup>OE</sup>  
Heated handlebar grips (➡ 79)
- 2 Riding mode (➡ 67)
- 3 Emergency off switch (kill switch) (➡ 59)
- 4 Start engine (➡ 89)

## Instrument panel

- 1 Speedometer
- 2 Rev. counter
- 3 Ambient-light brightness sensor (for adapting the brightness of the instrument lighting)  
– with alarm system (DWA)<sup>OE</sup>  
Anti-theft alarm telltale light – with Keyless Ride<sup>OE</sup>  
Telltale light for the radio-operated key
- 4 Warning and telltale lights (►► 20)
- 5 Multifunction display (►► 22)

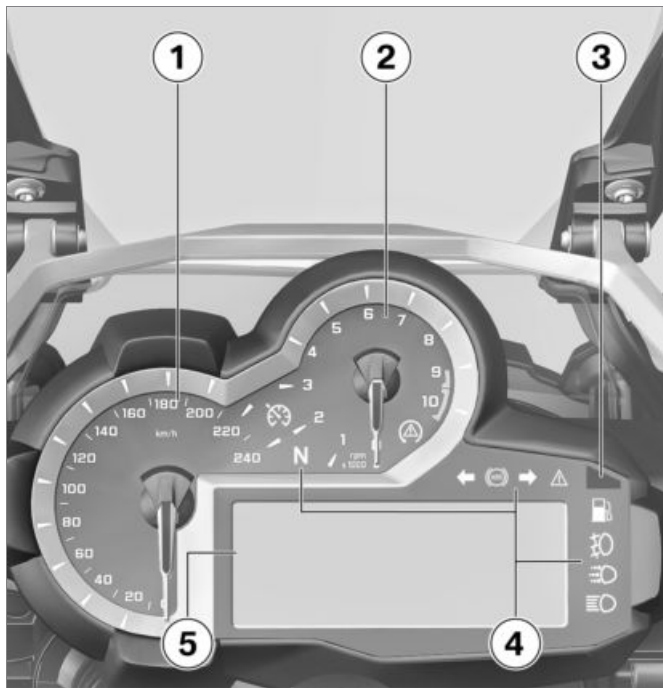

## Status indicators

Warning and telltale lights.....	20
Multifunction display .....	22
Warning symbols in the display .....	24
Warnings .....	25
Ambient temperature .....	39
Fuel reserve .....	40
Oil level .....	40
Service-due indicator .....	41
Tyre pressure.....	41
Recommendation to upshift .....	42

## Warning and telltale lights

- 1 – with cruise control<sup>OE</sup>  
Cruise-control system  
([► 71](#))
- 2 Neutral
- 3 ASC ([► 66](#))
- 4 Turn indicators, left
- 5 ABS ([► 65](#))
- 6 Turn indicators, right
- 7 General warning light (in combination with warning symbols in the display)  
([► 25](#))
- 8 DWA  
– with alarm system  
(DWA)<sup>OE</sup>  
Alarm ([► 58](#))  
Telltale light for the radio-operated key  
– with Keyless Ride<sup>OE</sup>  
Keys ([► 46](#))
- 9 High-beam headlight  
([► 61](#))

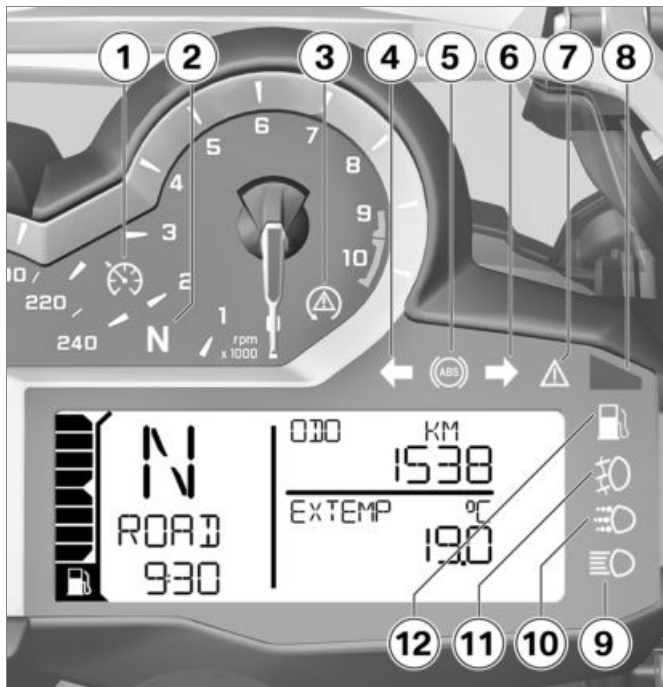

- 10 – with daytime running light<sup>OE</sup>  
Daytime riding light  
(☞ 62)
- 11 – with LED auxiliary headlights<sup>OA</sup>  
Auxiliary headlights (☞ 62)
- 12 Fuel reserve (☞ 40)



## NOTICE

The ABS symbol might differ, depending on the specifics of national regulations.◀

## Multifunction display

- 1 Fuel level
- 2 Recommendation to up-shift (➡ 42)
- 3 Gear indicator; "N" indicates neutral
- 4 – with daytime running light<sup>OE</sup>  
Automatic daytime running light (➡ 62)
- 5 – with heated handlebar grips<sup>OE</sup>  
Heating stages, handlebar grips (➡ 79)
- 6 Odometer and tripmeters (➡ 51)
- 7 Service-due indicator (maintenance interval) (➡ 184)
- 8 Warning symbols (➡ 25)
- 9 On-board computer  
– with Dynamic ESA<sup>OE</sup>  
ESA setting (➡ 75)
- 11 Riding mode (➡ 67)
- 12 Clock (➡ 54)





- 13** Outside temperature warning (  39)

## Warning symbols in the display

- 1 – with tyre pressure monitoring (RDC)<sup>OE</sup>  
Tyre pressure (➡ 33)
- 2 EWS (➡ 30)
- 3 Coolant temperature (➡ 31)
- 4 Engine oil level (➡ 38)
- 5 Engine electronics (➡ 31)
- 6 Battery charge (➡ 142)
- 7 Warnings (➡ 25)

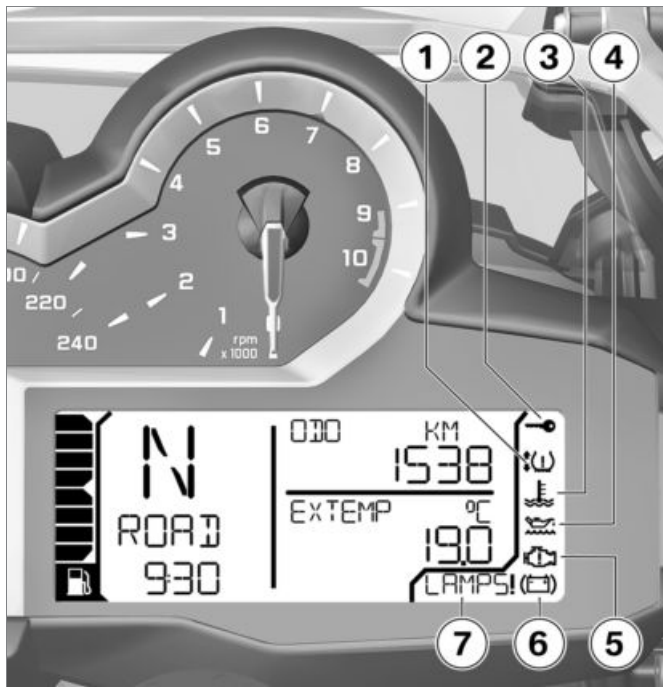

## Warnings

### Mode of presentation

Warnings are indicated by the corresponding warning lights.



Warnings that do not have warning lights of their own are indicated by 'General' warning light **1** showing in combination with a warning symbol at **2** or a text warning at **3**. The 'general' warning light shows yellow or red, depending on the urgency of the warning.













The status of the 'General' warning light matches the most urgent warning.

The possible warnings are listed on the next pages.

## Warnings, overview

### Warning and telltale lights







### Warning symbols in the display

			Meaning	
		appears on the display	Outside temperature warning (►►► 30)	
	lights up yellow		appears on the display	Electronic immobiliser active (►►► 30)
	lights up yellow		appears on the display	Radio-operated key out of range (►►► 30)
	lights up yellow			Replace the battery of the radio-operated key (►►► 31)
	lights up red		appears on the display	Coolant temperature too high (►►► 31)
	lights up yellow		appears on the display	Engine in emergency-operation mode (►►► 31)
	lights up yellow		! LAMP_ appears on the display	Bulb faulty (►►► 32)
			! LAMPF' appears on the display	









## Warning and telltale lights

## Warning symbols in the display

## Meaning

		DWA!O ! appears on the display	Anti-theft alarm battery weak (▣▣▣ 33)
 lights up yellow		DWA ! appears on the display	Anti-theft alarm battery flat (▣▣▣ 33)
 lights up yellow		is displayed with one or two arrows and the critical tyre pressure reading flashes	Tyre pressure close to limit of permitted tolerance (▣▣▣ 33)
 flashes red		is displayed with one or two arrows and the critical tyre pressure reading flashes	Tyre pressure outside permitted tolerance (▣▣▣ 34)
 lights up yellow		is displayed with one or two arrows	Sensor defective or system error (▣▣▣ 34)
		"--" or "-- --" is displayed	Signal transmission disrupted (▣▣▣ 35)

**Warning and telltale lights****Warning symbols in the display    Meaning**

	lights up yellow	RDC ! appears on the display	Battery of tyre-pressure sensor weak (→ 35)
	flashes		ABS self-diagnosis not completed (→ 36)
	lights up		ABS fault (→ 36)
	lights up		ABS deactivated (→ 36)
	quick-flashes		ASC intervention (→ 36)
	slow-flashes		ASC self-diagnosis not completed (→ 37)
	lights up		ASC deactivated (→ 37)
	lights up		ASC fault (→ 37)

## Warning and telltale lights

## Warning symbols in the display

## Meaning



lights up yellow

ESA ! appears on the display

ESA fault (→ 37)



lights up

Fuel down to reserve (→ 38)



flashes yellow



flashes

Severe fault in the engine control unit (→ 38)



appears on the display

Engine-oil level too low (→ 38)

OILLVL CHECK  
appears on the display



lights up red



appears on the display

Battery charge voltage insufficient (→ 39)

## Outside temperature warning



The ice-crystal symbol appears on the display.

Possible cause:



The air temperature measured at the vehicle is lower than:

approx. 3 °C



**WARNING**

**Risk of black ice forming at temperatures above 3 °C, even though no ambient-temperature warning is issued.**

Risk of accident due to icy surface.

- Always take extra care when temperatures are low; remember that there is particular danger of black ice

forming on bridges and where the road is in shade.◀

- Ride carefully and think well ahead.

## Electronic immobiliser active



The "General" warning light shows yellow.



The warning symbol for the electronic immobiliser appears on the display.

Possible cause:

The key being used is not authorised for starting, or communication between key and engine electronics is disrupted.

- Remove all other vehicle keys from the same ring as the ignition key.
- Use the emergency key.
- Have the defective key replaced, preferably by an authorised BMW Motorrad dealer.

## Radio-operated key out of range

– with Keyless Ride<sup>OE</sup>



The "General" warning light shows yellow.



appears on the display.

Possible cause:

Communication between R/C key and engine electronics is disrupted.

- Check the battery in the radio-operated key.
- with Keyless Ride<sup>OE</sup>
- Replacing battery of radio-operated key (►► 50).
- Use the reserve key to continue your journey.
- with Keyless Ride<sup>OE</sup>
- Battery of the radio-operated key is empty or loss of the radio-operated key (►► 49).
- Remain calm if the warning symbol appears while you are



riding. You can continue your journey, the engine will not switch off.

- Have the defective radio-operated key replaced by an authorised BMW Motorrad dealer.

## Replace the battery of the radio-operated key

 The "General" warning light shows yellow.

 The battery symbol appears on the display.

Possible cause:

- The integral battery in the radio-operated key has lost a significant proportion of its original capacity. There is no assurance of how long the R/C key can remain operational.
- with Keyless Ride<sup>OE</sup>
- Replacing battery of radio-operated key (🔑➔ 50).

## Coolant temperature too high



The "General" warning light shows red.



Temperature symbol appears on the display.



### ATTENTION

## Riding with overheated engine.

Engine damage

- Compliance with the information set out below is essential.◀

Possible cause:

The coolant level is too low.

- Check coolant level (🔍➔ 122).
- If the coolant level is too low:
- Top up the coolant and have the coolant system checked by a specialist workshop, preferably by an authorised BMW Motorrad dealer.

Possible cause:

The coolant temperature is too high.

- If possible, ride in the part-load range to cool down the engine.
- If the coolant temperature is frequently too high, have the fault rectified as soon as possible by a specialist workshop, preferably an authorised BMW Motorrad dealer.

## Engine in emergency-operation mode



The "General" warning light shows yellow.



The engine symbol appears on the display.



### WARNING

**Unusual ride characteristics when engine running in emergency-operation mode.**

Risk of accident

- Adapt your style of riding accordingly.
- Avoid accelerating sharply and overtaking.◀

Possible cause:

The engine control unit has diagnosed a fault. In exceptional cases, the engine stops and refuses to start. Otherwise, the engine runs in emergency operating mode.

- You can continue to ride, but bear in mind that the usual engine performance might not be available.
- Have the fault rectified as quickly as possible by a specialist workshop, preferably an authorised BMW Motorrad dealer.

## Bulb faulty



The "General" warning light shows yellow.

! LAMP\_ appears on the display.

- ! LAMP R: Brake light, rear light, indicator light rear or license plate light faulty.
- ! LAMP F: Low-beam headlight, high-beam headlight, parking light or front turn indicator defective.
- ! LAMP S: Several bulbs defective.
- with daytime running light<sup>OE</sup>
- ! LAMP F: Additionally: daytime riding light faulty.<



## WARNING

**Failure of lights on the vehicle adds to possibility of other road users overlooking the vehicle.**

Safety risk

- Replace defective bulbs as soon as possible; always carry a complete set of spare bulbs if possible.◀

Possible cause:

One or more bulbs defective.

- Identify defective bulb or bulbs by visual check.
- Replacing bulbs for low-beam and high-beam headlight (▣▶ 133).
- Replacing bulb for parking light (▣▶ 135).
- Replacing LED headlight (▣▶ 138).
- Replacing bulbs for front and rear turn indicators (▣▶ 136).
- Replacing LED rear light (▣▶ 138).
- Replacing LED turn indicators (▣▶ 138).

## Anti-theft alarm battery weak

– with alarm system (DWA)<sup>OE</sup>

DWA!O ! appears on the display.

### NOTICE

This error message shows briefly only after the Pre-Ride-Check completes. ◀

Possible cause:

The integral battery in the anti-theft alarm has lost a significant proportion of its original capacity. There is no assurance of how long the anti-theft alarm can remain operational if the vehicle's battery is disconnected.

- Seek the advice of a specialist workshop, preferably an authorised BMW Motorrad dealer.

## Anti-theft alarm battery flat

– with alarm system (DWA)<sup>OE</sup>



The "General" warning light shows yellow.

DWA ! appears on the display.



### NOTICE

This error message shows briefly only after the Pre-Ride-Check completes. ◀

Possible cause:

The integral battery in the anti-theft alarm has lost its entire original capacity. There is no assurance that the anti-theft alarm will be operational if the vehicle's battery is disconnected.

- Seek the advice of a specialist workshop, preferably an authorised BMW Motorrad dealer.

## Tyre pressure close to limit of permitted tolerance

– with tyre pressure monitoring (RDC)<sup>OE</sup>



The "General" warning light shows yellow.



The tyre symbol with one or two arrows appears on the display. The critical tyre pressure reading flashes.

The up arrow indicates a front-tyre pressure problem, the down arrow indicates a rear-tyre pressure problem.

Possible cause:

Measured tyre pressure is close to the limit of permitted tolerance.

- Correct the tyre pressure as stated on the inside cover of the Rider's Manual.

 **NOTICE**

Before you adjust tyre pressure, read the information on temperature compensation and adjusting pressure in the section entitled "Engineering details".◀

### Tyre pressure outside permitted tolerance

– with tyre pressure monitoring (RDC)<sup>OE</sup>



The "General" warning light flashes red.



The tyre symbol with one or two arrows appears on the display. The critical tyre pressure reading flashes.

 **WARNING**

### Tyre pressure outside permitted tolerance.

Impairment of the vehicle's handling characteristics.

- Adapt your style of riding accordingly.◀

The up arrow indicates a front-tyre pressure problem, the down arrow indicates a rear-tyre pressure problem.

Possible cause:

Measured tyre pressure is outside permitted tolerance.

- Check the tyre for damage and to ascertain whether the vehicle can be ridden with the tyre in its present condition.
- If the vehicle can be ridden with the tyre in its present condition:
- Correct the tyre pressure at the earliest possible opportunity.

 **NOTICE**

Before you adjust tyre pressure, read the information on temperature compensation and adjusting pressure in the section entitled "Engineering details".◀

 **NOTICE**

You can deactivate RDC warnings for riding in off-road mode.◀

- Have the tyre checked for damage by a specialist workshop, preferably an authorised BMW Motorrad dealer.

If you are unsure whether the vehicle can be ridden with the tyre in its present condition:

- Do not continue your journey.
- Notify the breakdown service.

### Sensor defective or system error

– with tyre pressure monitoring (RDC)<sup>OE</sup>



The "General" warning light shows yellow.



The tyre symbol with one or two arrows appears on the display.

Possible cause:

Vehicle is fitted with wheels not equipped with RDC sensors.

- Fit wheels and tyres equipped with RDC sensors.

Possible cause:

1 or 2 RDC sensors have failed or a system error has occurred.

- Have the fault rectified by a specialist workshop, preferably an authorised BMW Motorrad dealer.

## Signal transmission disrupted

– with tyre pressure monitoring (RDC)<sup>OE</sup>

"--" or "-- --" is displayed.

Possible cause:

The vehicle did not reach the minimum required speed (► 112).

 RDC sensor is not active
min 30 km/h (The RDC sensor does not transmit its signal to the vehicle until a certain minimum speed has been reached.)

- Increase speed above this threshold and observe the RDC readings. Assume that a permanent fault has not occurred unless the 'General' warning light comes on to accompany the symptoms. Under these circumstances:
- Have the fault rectified by a specialist workshop, preferably an authorised BMW Motorrad dealer.

Possible cause:

Wireless communication with the RDC sensors has been disrupted. Possible causes include radio-communication systems operat-

ing in the vicinity and interfering with the link between the RDC control unit and the sensors.

- Move to another location and observe the RDC readings. Assume that a permanent fault has not occurred unless the 'General' warning light comes on to accompany the symptoms. Under these circumstances:
- Have the fault rectified by a specialist workshop, preferably an authorised BMW Motorrad dealer.

## Battery of tyre-pressure sensor weak

– with tyre pressure monitoring (RDC)<sup>OE</sup>



The "General" warning light shows yellow.

RDC ! appears on the display.

**NOTICE**

This error message shows briefly only after the Pre-Ride-Check completes. ◀

Possible cause:

The integral battery in the tyre-pressure sensor has lost a significant proportion of its original capacity. There is no assurance of how long the tyre pressure control system can remain operational.

- Seek the advice of a specialist workshop, preferably an authorised BMW Motorrad dealer.

**ABS self-diagnosis not completed**

ABS warning light flashes.

Possible cause:



ABS self-diagnosis not completed

The ABS function is not available, because self-diagnosis did not complete. (The motorcycle has to reach a defined minimum speed for the wheel speed sensors to be checked: 5 km/h)

- Pull away slowly. Bear in mind that the ABS function is not available until self-diagnosis has completed.

**ABS fault**

ABS warning light flashes.

Possible cause:

The ABS control unit has detected a fault. The ABS function is not available.

- You can continue to ride. Bear in mind the more detailed in-

formation on situations that can lead to an ABS fault message (▶ 108).

- Have the fault rectified as quickly as possible by a specialist workshop, preferably an authorised BMW Motorrad dealer.

**ABS deactivated**

ABS warning light flashes.

Possible cause:

The rider has switched off the ABS system.

- Activate the ABS function.

**ASC intervention**

The ASC warning light quick-flashes.

The ASC has detected a degree of instability at the rear wheel and has intervened to reduce torque. The warning light flashes for longer than ASC intervention lasts. This affords the rider visual

feedback on control intervention even after the critical situation has been dealt with.

## ASC self-diagnosis not completed



The ASC warning light slow-flashes.

Possible cause:



ASC self-diagnosis not completed

The ASC function is not available, because self-diagnosis did not complete. (The motorcycle has to reach a defined minimum speed for the wheel sensors to be checked: min 5 km/h)

- Pull away slowly. The ASC warning light must go out within a few metres.

If the ASC warning light continues to flash:

- Seek the advice of a specialist workshop, preferably an authorised BMW Motorrad dealer.

## ASC deactivated



The ASC warning light shows.

Possible cause:

The rider has switched off the ASC system.

- Switch on the ASC function.

## ASC fault



The ASC warning light shows.

Possible cause:

The ASC control unit has detected a fault. The ASC function is not available.

- You can continue to ride. Bear in mind that the ASC function is not available. Bear in mind the more detailed information

on situations that can lead to an ASC fault (→ 111).

- Have the fault rectified as quickly as possible by a specialist workshop, preferably an authorised BMW Motorrad dealer.

## ESA fault



The "General" warning light shows yellow.

ESA! appears on the display.

Possible cause:

The ESA control unit has detected a fault. In this condition, the motorcycle has too much damping and is uncomfortable to drive, especially on roads in poor condition.

- Have the fault rectified as quickly as possible by a specialist workshop, preferably an authorised BMW Motorrad dealer.

## Fuel down to reserve



Warning light for fuel down to reserve shows.



### WARNING

## Irregular engine operation or engine shutdown due to lack of fuel.

Risk of accident. Damage to catalytic converter.

- Do not run the fuel tank dry. ◀

Possible cause:

The fuel tank contains no more than the reserve quantity of fuel.



Reserve fuel

approx. 4 l

- Refuelling (▶▶▶ 98).

## Severe fault in the engine control unit



General warning light flashes yellow.



The engine symbol flashes.



### WARNING

## Engine damage when running in emergency-operation mode.

Risk of accident

- Adapt your style of riding accordingly: Ride slowly, avoid sharp accelerating and overtaking.
- If possible, have the vehicle brought in and the fault rectified by a specialist workshop, preferably an authorised BMW Motorrad dealer. ◀

Possible cause:

The engine control unit has diagnosed a fault which may cause severe secondary faults. The engine is in emergency-operation mode.

- It is possible to continue to ride but not recommended.
- Avoid high load and rpm ranges if possible.
- Have the fault rectified as quickly as possible by a specialist workshop, preferably an authorised BMW Motorrad dealer.

## Engine-oil level too low



The oil-can symbol appears on the display.

OILLVL CHECK appears on the display.



Possible cause:

The electronic oil-level sensor has registered an excessively low oil level. The next time you stop for fuel:

- Check engine oil level (▬▶ 117). If the oil level is too low:
- Top up the engine oil (▬▶ 118). If the oil level is correct:
- Seek the advice of a specialist workshop, preferably an authorised BMW Motorrad dealer.

## Battery charge voltage insufficient



The "General" warning light shows red.



The battery symbol appears on the display.



## WARNING

**Non-availability of various systems such as lights, en-**

## gine or ABS on account of discharged battery.

Risk of accident

- Do not continue your journey.◀

Battery is not being charged. If you continue to ride the vehicle the on-board electronics will drain the battery.



## NOTICE

If the 12 V battery is not correctly installed or if the polarity of the terminals is reversed (e.g. in an attempt to jump-start the vehicle), this can cause the fuse for the alternator regulator to blow.◀

Possible cause:

Alternator or alternator drive faulty or fuse for alternator regulator has blown.

- Have the fault rectified as quickly as possible by a specialist workshop, preferably

an authorised BMW Motorrad dealer.

## Ambient temperature

When the motorcycle is at a standstill, the heat of the engine can falsify the ambient-temperature reading. If the effect of the engine's heat becomes excessive, — temporarily appears on the display.



At ambient temperatures below 3 °C, there is a risk of ice forming. When this temperature threshold is undershot for the first time, there will be an auto-

matic switchover to the ambient temperature display **1**, irrespective of the actual display setting; the displayed value flashes.



In addition, the ice crystal symbol **2** is shown.



## WARNING

**Risk of black ice forming at temperatures above 3 °C, even though no ambient-temperature warning is issued.**

Risk of accident due to icy surface.

- Always take extra care when temperatures are low; remember that there is particular danger of black ice forming on bridges and where the road is in shade.◀

## Fuel reserve

The amount of fuel present in the fuel tank when the fuel warning light is switched on is dependent on vehicle dynamics. The more the fuel moves inside the tank (due to regularly changing angles of heel, frequent braking and acceleration), the more difficult it becomes to determine the reserve volume. For this reason, the fuel reserve volume cannot be displayed exactly.



After the fuel warning light has switched on, the range is displayed automatically. The distance that can still be travelled using the reserve volume depends on the style of driving (usage) and the amount of fuel remaining at the time the light came on (see explanation above).

The odometer for the fuel reserve is reset when the amount of fuel after refuelling is greater than the reserve volume.

## Oil level



The oil-level indicator **1** gives you an indication of the engine oil level. You can call up this reading only when the vehicle is at a standstill.

The preconditions for the oil level check are as follows:

- Engine at operating temperature
- Engine idling for at least ten seconds
- Side stand retracted
- Motorcycle standing upright on a smooth, level surface

The readings mean:

OK: Oil level is correct.

CHECK: Check the oil level the next time you stop for fuel.

---: Oil level cannot be measured (conditions as stated above not satisfied).



If the oil level needs to be checked, the symbol **2** is displayed until the oil level is detected as being correct again.

## Service-due indicator



If the time remaining to the next service is less than a month or if the next service falls due within 1000 km, service due date **1** and countdown distance **2** show briefly after the Pre-Ride-Check completes.



If service is overdue, the due date or the odometer reading at which service was due is accompanied by the 'General' warning light showing yellow. The word "Service" remains permanently visible.



## NOTICE

If the service-due indicator appears more than a month before the service date, the date saved in the instrument cluster must be adjusted. This situation can occur if the battery was disconnected for a prolonged period of time.

If you want to have the date set consult a specialist workshop, preferably an authorised BMW Motorrad dealer. ◀

## Tyre pressure

- with tyre pressure monitoring (RDC)<sup>OE</sup>



The front tyre pressure is on the left **1**; the reading on the right **2** is the rear tyre pressure. "-- --" appears in the display directly after the ignition is switched on. The sensors do not transmit tyre pressures until the first time the vehicle accelerates to more than 30 km/h. The reference tyre-air temperature for these tyre-pressure readings is always 20 °C.

 If the symbol **3** also shows, this is a warning. The critical tyre pressure flashes.

 If the value in question is close to the limit of the permissible tolerance range, the reading is accompanied by the 'General' warning light showing yellow. If the tyre pressure registered by the sensor is outside the permissible tolerance range, the 'General' warning light flashes red.

The detailed description of BMW Motorrad RDC starts on page (➡ 112).

## Recommendation to upshift

The upshift recommendation must be activated in the display settings (➡ 52).



The upshift recommendation **1** signals the economically best point in time for upshift.

## Operation

Ignition.....	44	Spring preload .....	73
Ignition with Keyless Ride.....	46	Damping .....	74
Multifunction display .....	51	Dynamic ESA, electronic suspension adjustment.....	75
Anti-theft alarm (DWA).....	57	Clutch .....	77
Emergency off switch (kill switch).....	59	Brakes .....	78
Headlight .....	60	Tyres .....	78
Lights.....	61	Handlebars .....	79
Daytime riding light .....	62	Heated handlebar grips .....	79
Turn indicators.....	64	Mirrors .....	80
Hazard warning flashers.....	65	Windscreen .....	80
BMW Motorrad Integral ABS .....	65	Front and rear seats .....	81
Automatic Stability Control ASC ....	66		
Riding mode .....	67		
Cruise-control system .....	71		

## Ignition

### Keys

You receive 2 ignition keys.

Please consult the information on the electronic immobiliser (EWS) if a key is lost or mislaid (▶▶▶ 46). Ignition switch/steering lock, fuel filler cap lock and seat lock are all operated with the same key.

- with cases<sup>OA</sup>
- with topcase<sup>OA</sup>

If you wish you can arrange to have the cases and the top-case fitted with locks that can be opened with the ignition key as well. Consult a specialist workshop, preferably an authorised BMW Motorrad dealer.

## Locking the handlebars



### ATTENTION

#### Handlebars turned in wrong direction when motorcycle propped on side stand.

Risk of damage to parts if vehicle topples.

- On level ground, always turn the handlebars to the left to set the steering lock.
- In all other cases it is the lie of the ground that determines the direction in which the handlebars should be turned.◀
- Turn the handlebars to the full left or right lock position.

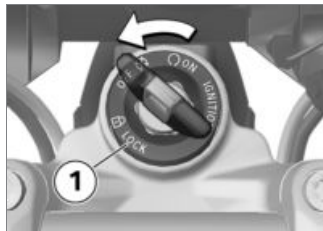

- Turn the key to position **1**, while moving the handlebars slightly.
  - » Ignition, lights and all function circuits switched off.
  - » Handlebars are locked.
  - » Key can be removed.

## Switching on ignition

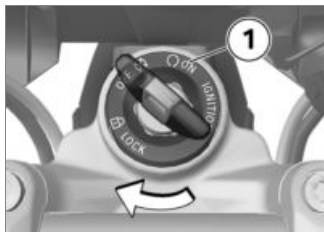

- Insert the key in the ignition switch and turn to position **1**.
  - » Side lights and all function circuits are switched on.
  - » Pre-Ride-Check is performed (►► 90)
  - » ABS self-diagnosis is performed (►► 90)
  - » ASC self-diagnosis is performed (►► 91)

## Welcome lights

- with LED headlights<sup>OE</sup>
- with daytime running light<sup>OE</sup>
- with LED auxiliary headlights<sup>OA</sup>

- Switch on the ignition.
  - » The side lights briefly light up.
    - with daytime running light<sup>OE</sup>
  - » The daytime riding lights briefly light up.<
  - with LED auxiliary headlights<sup>OA</sup>
    - » The LED auxiliary headlights briefly light up.<

## Switching off ignition

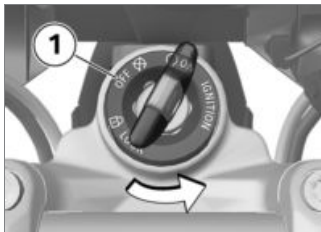

- Turn the ignition key to position **1**.
  - » When the ignition is switched off, the instrument cluster remains switched on for a short

- time and displays any existing fault messages.
  - » Handlebars not locked.
  - » Electrically powered accessories remain operational for a limited period of time.
  - » The battery can be recharged via the socket.
  - » Key can be removed.

- with daytime running light<sup>OE</sup>
- with LED headlights<sup>OE</sup>
- The daytime running light goes out soon after the ignition is switched off.<
- with LED auxiliary headlights<sup>OA</sup>
- The LED auxiliary headlights go out soon after the ignition is switched off.<

## Electronic immobiliser EWS

The electronic design of the motorcycle allows it to access data stored in the ignition key by means of a ring antenna located in the ignition switch/steering lock. The engine control unit will not permit the engine to be started unless the key is identified as "authorised".

### NOTICE

A spare key attached to the same ring as the ignition key used to start the engine could "irritate" the electronics, in which case the enabling signal for starting is not issued. The warning with the key symbol appears in the multifunction display.

Always keep the spare key separately from the ignition key. ◀

If you lose your key, you can have it barred by your authorised BMW Motorrad dealer.

If you wish to do this, you will need to bring all other keys for the motorcycle with you. The engine cannot be started by a barred key, but a key that has been barred can subsequently be reactivated.

You can obtain emergency/extra keys only through an authorised BMW Motorrad dealer. The keys are part of an integrated security system, so the dealer is under an obligation to check the legitimacy of all applications for replacement/extra keys.

## Ignition with Keyless Ride

– with Keyless Ride<sup>OE</sup>

## Keys

### NOTICE

The telltale light for the radio-operated key flashes while the search for the radio-operated key is in progress.

The telltale light goes out as soon as the radio-operated key or the emergency key is found. The telltale light goes out briefly if the search times out without the radio-operated key or the emergency key being found. ◀

You receive one radio-operated key and one emergency key. Please consult the information on the electronic immobiliser (EWS) if a key is lost or mislaid (▶▶ 46). Ignition, fuel filler cap and anti-theft alarm system all work with the radio-operated key. Seat lock, topcase and cases can be locked and unlocked manually.



## NOTICE

The vehicle cannot be started or the central locking system locked or unlocked if the radio-operated key is not within range (e.g. key inside one of the cases or the topcase).

If the key is taken out of range the ignition is switched off after approximately 1.5 minutes, but the central locking system is **not** locked.

It is advisable to keep the radio-operated key on your person (e.g. in a jacket pocket) and to have the emergency key with you as an alternative.◀



Range of the Keyless Ride radio-operated key

– with Keyless Ride<sup>OE</sup>

approx. 1 m◀

## Lock the handlebars

Precondition: Handlebars turned to the right or left full-lock position. Radio-operated key is within range.

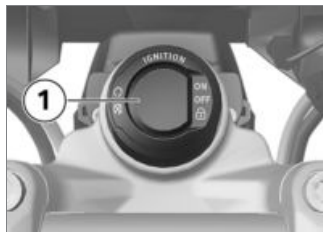

## ATTENTION

### Handlebars turned in wrong direction when motorcycle propped on side stand.

Risk of damage to parts if vehicle topples.

- On level ground, always turn the handlebars to the left to set the steering lock.

- In all other cases it is the lie of the ground that determines the direction in which the handlebars should be turned.◀
- Press and hold down button **1**.
  - » The steering lock engages with an audible click.
  - » Ignition, lights and all function circuits switched off.
- Short-press button **1** to disengage the steering lock.

## Switching on ignition

Precondition: Radio-operated key is within range.

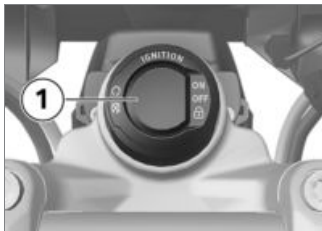

- There are **two** ways of activating the ignition.

#### Version 1:

- Short-press button **1**.
  - » Side lights and all function circuits are switched on.
    - with daytime running light<sup>OE</sup>
    - with LED headlights<sup>OE</sup>
  - » Daytime riding light is switched on.<
  - with LED auxiliary headlights<sup>OA</sup>
  - » LED auxiliary headlights are switched on.<
  - » Pre-Ride-Check is performed (▣▣▣ 90)

- » ABS self-diagnosis is performed (▣▣▣ 90)
- » ASC self-diagnosis is performed (▣▣▣ 91)

#### Version 2:

- Steering lock is engaged; press and hold down button **1**.
  - » The steering lock disengages.
  - » Parking lights and all function circuits switched on.
  - » Pre-Ride-Check is performed (▣▣▣ 90)
  - » ABS self-diagnosis is performed (▣▣▣ 90)
  - » ASC self-diagnosis is performed (▣▣▣ 91)

#### Switching off ignition

Precondition: Radio-operated key is within range.

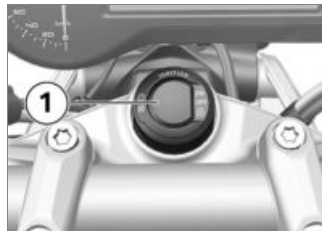

- There are **two** ways of deactivating the ignition.

#### Version 1:

- Short-press button **1**.
  - » Light is switched off.
  - » Handlebars (steering lock) are not locked.

#### Version 2:

- Turn the handlebars to the full left or right lock position.
- Press and hold down button **1**.
  - » Light is switched off.
  - » The steering lock engages.

## Electronic immobiliser EWS

The on-board electronics access the data saved in the radio-operated key via a ring aerial in the R/C ignition lock. The ignition is not enabled for starting until the engine control unit has recognised the radio-operated key as "authorised" for your motorcycle.



### NOTICE

A spare vehicle key attached to the same ring as the radio-operated key used to start the engine could "irritate" the electronics, in which case the enabling signal for starting is not issued. The warning with the key symbol appears in the multifunction display. Always keep the spare key separately from the radio-operated key. ◀

If you mislay a radio-operated key you can have the key in question barred by your authorised BMW Motorrad dealer. In order to have a key barred you must bring along all the other keys belonging to the motorcycle.

The engine cannot be started by a barred radio-operated key, but a radio-operated key that has been barred can subsequently be reactivated.

You can obtain emergency/extra keys only through an authorised BMW Motorrad dealer. The radio-operated keys are part of an integrated security system, so the dealer is under an obligation to check the legitimacy of all applications for replacement/extra keys.

## Battery of the radio-operated key is empty or loss of the radio-operated key

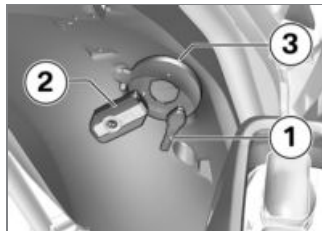

- Please consult the information on the electronic immobiliser (**EWS**) if a key is lost or mislaid.
- If you happen to lose or mislay the radio-operated key while on a journey, you can start the vehicle with the emergency key.
- If the battery of the radio-operated key is empty, touching the radio-operated key against the





Battery type

CR 2032

- Install battery cover **2**.
- » Red LED on the instrument panel flashes.
- » The remote control is again ready for use.

## Multifunction display

### Selecting the display

- Switching on ignition (☛ 45).



- Briefly press button **1** in order to select the display in the top display line **2**.

In the standard equipment the following values can be displayed and selected at the press of a button:

- Total distance travelled (ODO)
- Tripmeter 1 (TRIP I)
- Tripmeter 2 (TRIP II)
- Range (RANGE)
- SETUP-menu (SETUP), only when stationary

- with Pro onboard computer<sup>OE</sup>
- The following information is additionally displayed by means of the on-board computer Pro:
- Automatic tripmeter (TRIP A)
  - Current consumption (CONS C)
  - Current speed (SPEED)◀



- Briefly press button **1** in order to select the display in the bottom display line **2**.

In the standard equipment the following values can be displayed and selected at the press of a button:

- Ambient temperature (EX-TEMP)
- Engine temperature (EN-GTMP)
- Average consumption 1 (CONS 1)
- Average consumption 2 (CONS 2)
- Average speed (Ø SPEED)
- with tyre pressure monitoring (RDC)<sup>OE</sup>
- Tyre pressures (RDC)<
- Date (DATE)
- Oil-level reminder (OILLVL)
- with Pro onboard computer<sup>OE</sup>
- Vehicle circuit voltage (VOLTGE)<
- with Pro onboard computer<sup>OE</sup>
- Stopwatch total time (ALTIME)<
- with Pro onboard computer<sup>OE</sup>
- Stop watch driving time (RDTIME)<

## Resetting tripmeter

- Switching on ignition (▶▶▶ 45).



- Repeatedly press button **1** briefly until the tripmeter to be reset is indicated in the top display line **2**.
- Press and hold down button **1** until the value shown is reset.

## Resetting the average values

- Switching on ignition (▶▶▶ 45).



- Repeatedly press button **1** briefly until the average value to be reset is indicated in the bottom display line **2**.
- Press and hold down button **1** until the value shown is reset.

## Configuring functions

- Switching on ignition (▶▶▶ 45).



- Repeatedly press button **1** briefly until the top display line displays **2** SETUP ENTER.
- Press and hold button **1** to start the SETUP menu.
- » The following indication in the display depends on the equipment selected.

- Press button **1** briefly in order to go to the next menu item.
    - » The top display line **2** shows the menu item.
    - » The bottom display line **3** shows the preset value.
  - Press button **4** briefly in order to change the set value.
- The following menu items can be selected:
- with alarm system (DWA)<sup>OE</sup>
  - DWA: Switch alarm system ON or OFF<

- with preparation for navigation system<sup>OE</sup>
- GPS TM: Navigation system installed: Accept GPS time and GPS date (ON) or do not accept (OFF)<
- CLOCK: Setting the clock
- DATE: Setting the date
- ECOSFT: Show upshift recommendation on the display (ON) or not (OFF)
- BRIGHT: Set display brightness, from normal (0) to bright (5)
- with daytime running light<sup>OE</sup>
- DLIGHT: Switch daytime riding light ON or OFF<
- EXIT: Exit SETUP menu
- with Pro onboard computer<sup>OE</sup>
- BC CUSTOM: Start individualisation of the display.<



- In order to exit the SETUP menu, at the menu item SETUP EXIT press and hold button **1**.
- In order to cancel the SETUP menu at any point, press button **2** and hold.

### Setting the clock

- Switching on ignition (➡ 45).



#### WARNING

### Adjusting the clock while riding.

Risk of accident

- Set the clock only when the motorcycle is stationary.◀
- In the SETUP menu, select the menu item SETUP CLOCK.



- Keep button **2** pressed until the hours in the bottom display line **3** start to flash.



#### NOTICE

If "-- : --" is displayed instead of the time, the voltage supply of the instrument cluster has been interrupted (e.g. by disconnecting the battery).◀

- Press button **1** to increase the flashing value or button **2** to reduce the same.
- Keep button **2** pressed until the minutes in the bottom display line **3** start to flash.
- Press button **1** to increase the flashing value or button **2** to reduce the same.
- Keep button **2** pressed until the minutes no longer flash.
- » Setting is complete.
- In order to cancel the setting at any point, keep button **1** pressed until the initial value is shown again.



#### NOTICE

If you drive off before the setting has been completed, the setting will be cancelled.◀

### Setting the date

- Switching on ignition (➡ 45).



- In the **SETUP** menu, select the menu item **SETUP DATE**.



- Keep button **2** pressed until the day in the bottom display line **3** starts to flash.

#### NOTICE

If "-- . -- . --" is displayed instead of the date, the voltage supply of the instrument cluster has been interrupted (e.g. by disconnecting the battery).◀

- Press button **1** to increase the flashing value or button **2** to reduce the same.
- Keep button **2** pressed until the month in the bottom display line **3** starts to flash.
- Press button **1** to increase the flashing value or button **2** to reduce the same.
- Keep button **2** pressed until the year in the bottom display line **3** starts to flash.
- Press button **1** to increase the flashing value or button **2** to reduce the same.
- Keep button **2** pressed until the year no longer flashes.
- » Setting is complete.
- In order to cancel the setting at any point, keep button **1** pressed until the initial value is shown again.

#### NOTICE

If you drive off before the setting has been completed, the setting will be cancelled.◀

#### Customising the display – with Pro onboard computer<sup>OE</sup>

- Switching on ignition (▣ 45). In the customisation menu, it is possible to set which information is to be displayed in which display line.
- In the **SETUP** menu, select the menu item **SETUP BC BASIC**.



- Briefly press button **1** to start the customisation menu.
- » SETUP BC CUSTOM appears on the display.
- Briefly press button **1** again to exit the customisation menu.



#### NOTICE

If SETUP BC BASIC is selected, then the factory setting will be active again. The customisation CUSTOM remains stored.◀



- Press button **1** for a long period in order to display the first menu item.
- » SETUP BC ODO appears on the display.



- Press button **2** briefly in order to go to the next menu item.
- » The top display line **3** shows the menu item.
- » The bottom display line **4** shows the preset value. The following values can be set.
- TOP: The value is displayed in the top display line.
- BELOW: The value is displayed in the bottom display line.
- BOTH: The value is displayed in both display lines.
- OFF: The value is not displayed.

- Press button **1** briefly in order to change the set value.

The following menu items can be selected, the works setting is shown in brackets. Some menu items will only be selected if the relevant special equipment (OE) is actually present.

- ODO: Total mileage counter (TOP, the setting OFF is not possible)
- TRIP 1: Tripmeter 1 (TOP)
- TRIP 2: Tripmeter 2 (TOP)
- TRIP A: Automatic tripmeter (TOP)
- EXTEMP: Ambient temperature (BELOW)
- ENGTMP: Engine temperature (BELOW)
- RANGE: Range (TOP)
- CONS R: Average consumption for range calculation (OFF)
- CONS 1: Average consumption 1 (BELOW)

- CONS 2: Average consumption 2 (BELOW)
- CONS C: Current consumption (TOP)
- ØSPEED: Average speed (BELOW)
- SPEED: Current speed (TOP)
- RDC: Tyre pressures (BELOW)
- VOLTGE: Vehicle circuit voltage (BELOW)
- ALTIME: Stopwatch total time (BELOW)
- RDTIME: Stopwatch driving time (BELOW)
- DATE: Date (BELOW)
- SERV T: Date of the next service (OFF)
- SERV D: Countdown distance to next service (OFF)
- OILLVL: Oil level note (BELOW)
- EXIT: Exit customisation menu



- When the menu item SETUP EXIT is displayed, press and hold button **1** to exit the customisation menu.
- In order to exit the customisation menu at any point, press and hold button **2**.
  - » All settings made until then will be saved.

## Anti-theft alarm (DWA)

- with alarm system (DWA)<sup>OE</sup>

### Activation

- Switching on ignition (☐➔ 45).

- Customising anti-theft alarm settings (➡ 58).
- Switch off the ignition.
  - » If the alarm system is activated, then the alarm system will be automatically activated when the ignition is switched off.
  - » Activation takes approximately 30 seconds to complete.
  - » Turn indicators flash twice.
  - » Confirmation tone sounds twice (if programmed).
  - » Anti-theft alarm is active.

## Alarm

An alarm can be triggered by:

- motion sensor
- an attempt to use an unauthorised key to switch on the ignition
- disconnection of the anti-theft alarm from the motorcycle's battery (internal battery in the anti-theft alarm provides power

- alarm tone only, the turn indicators do not flash)

All functions are sustained even if the internal battery of the anti-theft alarm system is flat; the only difference is that an alarm cannot be triggered if the system is disconnected from the motorcycle's battery.

An alarm lasts for approximately 26 seconds. While an alarm is in progress an alarm tone sounds and the turn indicators flash. The type of alarm tone can be set by an authorised BMW motorcycle dealer.

If an alarm was triggered while the motorcycle was unattended, the rider is notified accordingly by an alarm tone sounding once when the ignition is switched on. The anti-theft alarm telltale light then signals the reason for the alarm for one minute.

The meanings of the flash codes are as follows:

- Flashes 1x: Motion sensor 1
- Flashes 2x: Motion sensor 2
- Flashes 3x: Ignition switched on with unauthorised key
- Flashes 4x: Disconnection of the anti-theft alarm from the motorcycle's battery
- Flashes 5x: Motion sensor 3

## Deactivation

- Kill switch in operating position (run).
- Switch on the ignition.
  - » Turn indicators flash once.
  - » Confirmation tone sounds once (if programmed).
  - » Anti-theft alarm is deactivated.

## Customising anti-theft alarm settings

- Switching on ignition (➡ 45).



- Repeatedly press button **1** briefly until the top display line displays **2** SETUP ENTER.
- Press and hold button **1** to start the SETUP menu.



- Press button **1** briefly to go to the next menu item DWA.
  - » In the top display line **2**, DWA is indicated.
  - » The bottom display line **3** shows the preset value.
- Press button **4** briefly in order to change the set value.

The following settings are available:

- On: The alarm system has been activated or will be activated automatically when the ignition is switched.
- Off: Alarm system is deactivated.

## Emergency off switch (kill switch)



- 1** Emergency off switch (kill switch)

### **WARNING**

#### **Operation of the kill switch while riding.**

Risk of fall due to rear wheel locking.

- Do not operate the kill switch when riding. ◀

The emergency off switch is a kill switch for switching off the engine quickly and easily.

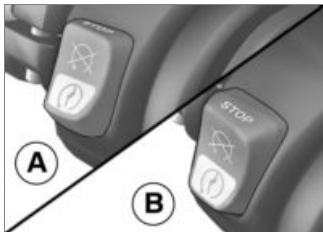

- A** Engine switched off  
**B** Normal operating position (run)

## Headlight

### Headlight beam throw and spring preload

Headlight beam throw is generally kept constant when spring preload is adjusted to suit load. Spring preload adjustment might not suffice only if the motorcycle

is very heavily loaded. Under these circumstances, headlight beam throw has to be adjusted to suit the weight carried by the motorcycle.

#### NOTICE

If there are doubts about the correct headlight beam throw, have the setting checked by a specialist workshop, preferably an authorised BMW Motorrad dealer. ◀

## Adjusting headlight beam throw



If, for a high load, the adjustment of the spring pre-load is no longer sufficient not to dazzle oncoming traffic:

- Turn adjuster knob **1** counter-clockwise in order to lower the headlight beam again.

When the motorcycle is again ridden with a lower load:

- Have the basic settings of the headlight restored by a specialist workshop, best of all by a BMW Motorrad dealer.

– with LED headlights<sup>OE</sup>

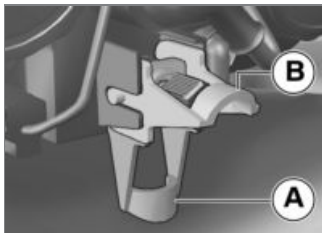

- The headlight beam-throw is adjusted via an engage pivot lever.
- **A** Neutral position
- **B** Position for heavy load◀

## Lights

### Low-beam headlight and sidelights

The side lights switch on automatically when the ignition is switched on.

### NOTICE

The side lights place a strain on the battery. Do not switch the ignition on for longer than absolutely necessary.◀

The low-beam headlight switches on automatically when the engine is switched on.

– with daytime running light<sup>OE</sup>

In daytime the daytime riding lights can be switched on as an alternative to the low-beam headlight.

### High-beam headlight and headlight flasher

- Switching on ignition (☞ 45).

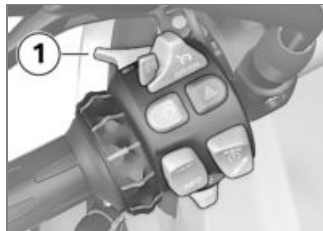

- Push switch **1** forward to switch on the high-beam headlight.
- Pull switch **1** back to operate the headlight flasher.

### Parking light

- Switching off ignition (☞ 45).

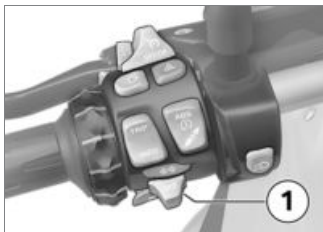

- Immediately after switching off the ignition, push button **1** to the left and hold it in this position until the parking lights come on.
- Switch the ignition on and off again to switch off the parking lights.

### Auxiliary headlights

– with LED auxiliary headlights<sup>OA</sup>

Precondition: The LED auxiliary headlights are active only when the low-beam headlight is active; if the daytime riding light is switched on, the LED auxiliary

headlights cannot be switched on.



### NOTICE

The auxiliary headlights have approval as fog lights and their use is permissible in bad weather conditions only. Always comply with the road traffic regulations in force in the country in which the vehicle is used.◀

- Start engine (▶▶▶ 89).



- Press button **1** to switch on the auxiliary headlights.



The indicator light for the auxiliary headlight illuminates.

- Press button **1** again to switch off the auxiliary headlights.

### Daytime riding light

– with daytime running light<sup>OE</sup>

### Manual daytime riding light

Precondition: automatic daytime riding light is switched off.



### WARNING

### Activation of daytime riding light in the dark.

Poorer vision and oncoming traffic dazzled.

- Do not use the daytime running light when it is dark.◀



### NOTICE

By comparison with the low-beam headlight, the daytime



running light makes the vehicle more visible to oncoming traffic. This improves daytime visibility.◀

- Start engine (▶▶▶ 89).
- In the display's SETUP menu, go to the DLIGHT menu item and set the automatic daytime riding light to OFF.

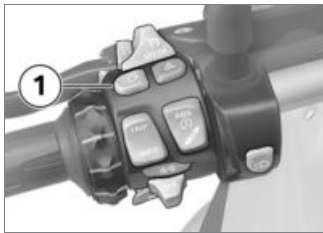

- Press button **1** to switch on the daytime riding light.

 The indicator light for the daytime riding light illuminates.

- » The low-beam headlight, the front side lights and the auxiliary headlight are switched off.
- In the dark or in tunnels: Press button **1** again to switch off the daytime riding light and switch on the low-beam headlight. The auxiliary headlight is also switched on again.

#### NOTICE

If the high beam headlight is switched on whilst the daytime riding light is switched on, the daytime riding light will be switched off after approx. 2 seconds, and the high beam headlight, low beam headlight, front side lights and, if applicable, the auxiliary headlights will be switched on. If the high beam headlight is switched off again, the daytime riding light is not automatically reactivated, but must be switched on again if required.◀

## Automatic daytime riding light

#### NOTICE

The changeover between daytime riding light and low beam headlight incl. front side lights can be effected automatically.◀

#### WARNING

**The automatic riding light control system cannot replace your personal assessment of lighting conditions, particularly in foggy or misty weather.**

Safety risk

- Manually switch on the low-beam headlight in poor lighting conditions.◀
- In the SETUP menu of the display, at the menu item DLIGHT set the automatic daytime riding light to ON.



The indicator light for the automatic daytime riding light illuminates.

» If the ambient brightness decreases below a certain value, the low beam headlight is automatically switched on (e. B. in a tunnel). If a sufficient ambient brightness is detected, the daytime riding light is switched on again. If the daytime riding light is active, the daytime riding light symbol is displayed in the multifunction display.

### Manual operation of the light when the automatic system is switched on

– If you press the button for the daytime running light the daytime running light is switched off and the low-beam headlight and front side lights are switched on (e. g. when you ride into a tunnel, and the

response of the automatic daytime running light to the change in ambient brightness is delayed). The auxiliary headlight switches on again when the daytime running light is switched off.

– If you press the button again the daytime riding light is re-activated, in other words the daytime riding light is switched on again when ambient light is bright enough.

## Turn indicators

### Operating the turn indicators

- Switching on ignition (➡ 45).



- Push button **1** to the left to switch on the left turn indicators.
- Push button **1** to the right to switch on the right turn indicators.
- Operate centre button **1** to cancel the turn indicators.



Turn-indicator cancellation

The turn indicators are cancelled automatically after the defined time and distance.

## Hazard warning flashers

### Operating hazard warning flashers

- Switching on ignition (▣▣▣▣ 45).

#### NOTICE

The hazard warning flashers place a strain on the battery. Do not use the hazard warning flashers for longer than absolutely necessary. ◀

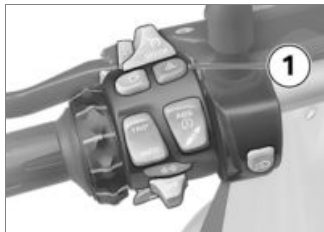

- Press button **1** to switch on the hazard warning flashers.

- » Ignition can be switched off.
- To switch off the hazard warning flashers, switch on the ignition if necessary and press button **1** again.

## BMW Motorrad Integral ABS

### Deactivating the ABS function

- Switching on ignition (▣▣▣▣ 45).

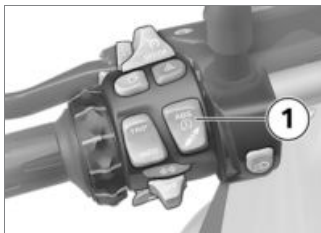

- Press and hold down button **1** until the ABS warning light changes status.

- » Initially, the ASC symbol changes status. Press and hold down button **1** until the ABS warning light responds. Under these circumstances, there is no change in the ASC setting.



ABS warning light flashes.

- Release button **1** within two seconds.



ABS warning light continues to flash.

- » The ABS function is deactivated, but the integral function remains active.

## Activating the ABS function

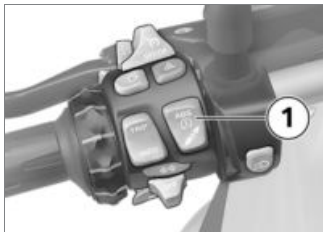

- Press and hold down button **1** until the ABS warning light changes status.

 ABS warning light goes out; if self-diagnosis has not completed it starts flashing.

- Release button **1** within two seconds.

 ABS warning light remains off or continues to flash.

» The ABS function is activated.

- You also have the option of switching the ignition off and then on again.

### NOTICE

An ABS fault has occurred if the ABS warning light shows when the motorcycle accelerates to a speed in excess of 5 km/h after the ignition was switched off and then on again. ◀

### NOTICE

See the section entitled "Engineering details" for more information on brake systems with BMW Motorrad Integral ABS. ◀

## Automatic Stability Control ASC

### Deactivating the ASC function

- Switching on ignition (➡ 45).

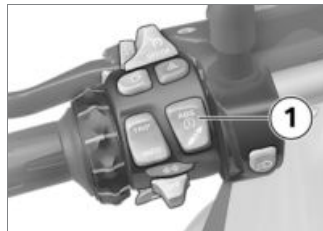

- Press and hold down button **1** until the ASC warning light changes status.

### NOTICE

You have the option of deactivating the ASC function while the motorcycle is on the move. ◀

 The ASC warning light shows.

- Release button **1** within two seconds.

 The ASC warning light still shows.

- » The ASC function is deactivated.

## Activating the ASC function

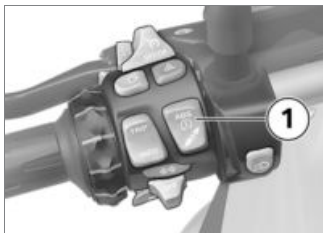

- Press and hold down button **1** until the ASC warning light changes status.

 The ASC warning light goes out; if self-diagnosis has not completed the warning light starts flashing.

- Release button **1** within two seconds.

 The ASC warning light still does not show or continues to flash.

- » The ASC function is activated.
- You also have the option of switching the ignition off and then on again.

### NOTICE

An ASC fault has occurred if the ASC warning light shows when the motorcycle accelerates to a speed in excess of 5 km/h after the ignition was switched off and then on again. ◀

### NOTICE

See the section entitled "Engineering details" for more information on BMW Motorrad Automatic Stability Control (ASC). ◀

## Riding mode

### Using the riding modes

BMW Motorrad has developed 5 operational scenarios for your motorcycle from which you can select the scenario suitable for your situation:

- Riding on a rain-wet road surface
- Riding on a dry road surface
- with Pro riding modes<sup>OE</sup>
- Sporty riding on a dry road surface
- Riding in easy off-road terrain
- Sporty off-riding

The interplay of engine torque, throttle response, ABS control and ASC control is optimised for each of these 5 scenarios.

– with Dynamic ESA<sup>OE</sup>

The chassis adjustment also adapts to the selected scenario.

## Setting riding mode

- Switching on ignition (➡ 45).



- Press button **1**.

### NOTICE

See the section entitled "Engineering details" for more information on the various ride modes that can be selected.◀



The selection arrow **1** and the first selectable riding mode **2** are displayed.



### ATTENTION

#### Activation of the off-road mode (Enduro and Enduro Pro) when riding on-road.

Risk of crash due to lack of stability when the vehicle brakes or accelerates in the control range of ABS or ASC.

- Activate off-road mode (Enduro and Enduro Pro) only for off-road riding.◀
- Press button **1** as often as necessary until the required riding mode is indicated next to the selection arrow.

## NOTICE

When the Enduro PRO mode is selected: Note that ABS control for the rear wheel is restricted (see the section entitled "Engineering details").◀

The following ride modes can be selected:

- RAIN: For riding on a rain-wet road surface.
- ROAD: For riding on a dry road surface.
- with Pro riding modes<sup>OE</sup>
  - » The following riding modes are additionally available for selection:
    - DYNA: For dynamic riding on a dry road surface.
    - Enduro: For off-roading.
    - Enduro PRO: For sporty off-road riding (with fitted coding plug only).◀

- » With the motorcycle at a standstill, the selected mode is activated after approximately two seconds.
- » The newly selected riding mode is activated as you ride only when the following preconditions are satisfied:
  - Throttle twistgrip in idle position
  - Clutch pulled
- » Following activation of the new riding mode the clock is displayed again.
- » The riding mode set, with the corresponding adaptations of engine characteristics, ABS, ASC and Dynamic ESA, is retained even after the ignition has been switched off.

## Deactivate the RDC for off-roading

– with Pro riding modes<sup>OE</sup>

You can deactivate RDC warnings for the Enduro and Enduro Pro riding modes when you want to lower the tyre pressures for off-roading.

- Switching on ignition (▣▶ 45).



- Repeatedly press button **1** briefly until the top display line displays **2** SETUP ENTER.
- Press and hold button **1** to start the SETUP menu.



- Press button **1** briefly to go to the next menu item RDC.
  - » In the top display line **2**, RDC is displayed.
  - » The bottom display line **3** shows the preset value.
- Press button **4** briefly in order to change the set value.
  - » The following settings are available:
    - ON: The RDC warning symbol in the display does not show. An out-of-tolerance tyre pressure is displayed in the Enduro and Enduro Pro riding modes.
    - OFF: The RDC warning symbol in the display shows and an

out-of-tolerance tyre pressure is displayed in the Enduro and Enduro Pro riding modes.

### Installing coding plug

– with Pro riding modes<sup>OE</sup>

- Switching off ignition (➔ 45).
- Remove front seat (➔ 81).



### ATTENTION

#### Dirt and damp penetrating inside open connectors.

Malfunctions

- Reinstall the cap after removing the coding plug.◀

- Remove cap of plug **1**.

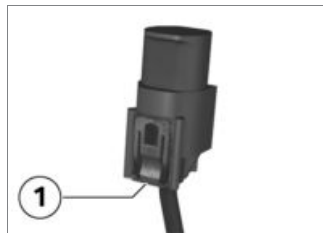

- To do so, press in latch **1** and remove the cap.
- Install the coding plug.
- Switch on the ignition.





The symbol **1** for the coding plug is shown in the display. The riding mode **2** Enduro PRO is selectable.

- » The selected riding mode is retained in memory, even after the ignition is switched off.
- Installing front seat (▶▶▶ 83).

## Cruise-control system

– with cruise control<sup>OE</sup>

### Switching on cruise control

Cruise control is not available until the Enduro or Enduro Pro riding mode has been deactivated.

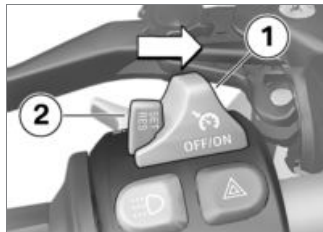

- Slide switch **1** to the right.
- » Button **2** is enabled for operation.

### Saving road speed



- Briefly push button **1** forward.

 Adjustment range for speed control

30...210 km/h

 Telltale light for cruise control shows.

- » The motorcycle maintains your current cruising speed and the setting is saved.

## Accelerating



- Briefly push button **1** forward.
  - » Speed is increased by approx. 2 km/h each time you push the button.
- Push button **1** forward and hold it in this position.
  - » The motorcycle accelerates steplessly.
  - » The current speed is maintained and saved if button **1** is not pushed again.

## Decelerating



- Briefly push button **1** back.
  - » Speed is reduced by approx. 2 km/h each time you push the button.
- Push button **1** back and hold it in this position.
  - » The motorcycle decelerates steplessly.
  - » The current speed is maintained and saved if button **1** is not pushed again.

## Deactivate cruise control

- Brake, pull the clutch lever or turn the throttle twistgrip (close the throttle by turning

the twistgrip back past the idle position) to deactivate the cruise-control system.

» Telltale light for cruise control goes out.

## Resuming former cruising speed



- Briefly push button **1** back to return to the speed saved beforehand.



### NOTICE

Opening the throttle does not deactivate the cruise-control system. If you release the twistgrip

the motorcycle will decelerate only to the cruising speed saved in memory, even though you might have intended slowing to a lower speed.◀

 Telltale light for cruise control shows.

## Switching off cruise control



- Slide switch **1** to the left.
- » The system is deactivated.
- » Button **2** is disabled.

## Spring preload

### Setting

It is essential to set spring preload of the rear suspension to suit the load carried by the motorcycle. Increase spring preload when the vehicle is heavily loaded and reduce spring preload accordingly when the vehicle is lightly loaded.

### Adjusting spring preload for rear wheel

#### WARNING

### Adjusting spring preload while riding.

Risk of accident

- Do not attempt to adjust spring preload unless the motorcycle is at a standstill.◀
- Make sure the ground is level and firm and place the motorcycle on its stand.



#### WARNING

### Spring preload setting and spring-strut damping setting not matched.

Impaired handling.

- Adjust spring-strut damping to suit spring preload.◀
- If you want to increase spring preload, turn knob **1** in the direction indicated by the HIGH arrow.
- If you want to reduce spring preload, turn knob **1** in the direction indicated by the LOW arrow.



Basic setting of spring preload, rear

– without Dynamic ESA<sup>OE</sup>

Turn adjuster knob in direction LOW until the stop position is reached (One-up riding without luggage)

Turn the adjuster as far as it will go in the LOW direction, then turn it back 15 turns in the HIGH direction (One-up with luggage)

Turn the adjuster as far as it will go in the LOW direction, then turn it back 30 turns in the HIGH direction (Two-up riding and luggage) <math>\sphericalangle</math>

## Damping Setting

Damping must be adapted to suit the surface on which the motorcycle is ridden and to suit spring preload.

- An uneven surface requires softer damping than a smooth surface.
- An increase in spring preload requires firmer damping, a reduction in spring preload requires softer damping.

### Adjust the damping for rear wheel

- Make sure the ground is level and firm and place the motorcycle on its stand.
- Work on the left-hand side of the vehicle when adjusting the damping.



- If you want to increase damping, turn adjusting screw **1** clockwise.
- If you want to reduce damping, turn adjusting screw **1** counter-clockwise.



Basic setting of rear-suspension damping characteristic

– without Dynamic ESA<sup>OE</sup>

Turn the knob as far as it will go in the clockwise direction, then back it off 8 clicks in the counter-clockwise direction (One-up without luggage)



Basic setting of rear-suspension damping characteristic

Turn the knob as far as it will go in the clockwise direction, then back it off 2 clicks in the counter-clockwise direction (One-up with luggage)

Turn the knob as far as it will go in the clockwise direction, then back it off 2 clicks in the counter-clockwise direction (Two-up with luggage)◁

## Dynamic ESA, electronic suspension adjustment

– with Dynamic ESA<sup>OE</sup>

### Possible settings

Using the electronic chassis adjustment Dynamic ESA you can comfortably adapt your motorcycle to the actual vehicle load.

Via ride height sensors, Dynamic ESA detects the movements in the chassis and suspension and responds to the same by adjusting the damper valves. The chassis and suspension will thus be adapted to the characteristics of the terrain.

Starting from the basic setting NORMAL, the damping can be made harder (HARD) or softer (SOFT).

– with Pro riding modes<sup>OE</sup>

The setting of the chassis and suspension and the number of the selectable damping variants depend on the riding mode selected. The damping specified by the riding mode can be changed by the driver.

If the coding plug is not fitted, the basic setting specified by the riding mode will be set after each mode change. If the coding plug

is fitted, the driver's adjustments are retained for all modes.

## Viewing suspension settings

- Switching on ignition (☰➔ 45).



- Press button **1** briefly to view the current setting.



In the multifunction display, the damping is shown in area **1**, the spring preload in area **2**.

» The setting shows briefly, then disappears automatically.

## Adjusting the chassis and suspension

- Switching on ignition (▶▶▶ 45).



- Press button **1** briefly to view the current setting.
- To adjust damping:
- Repeatedly press button **1** until the setting you want to use appears on the display.



### NOTICE

You can adjust the damping characteristic while the motorcycle is on the move.◀

The following settings are available:

- SOFT: Comfortable damping characteristic

- NORMAL: Normal damping characteristic
- HARD: Sporty damping characteristic

– with Pro riding modes<sup>OE</sup>  
In the Enduro and Enduro Pro modes, only two settings are possible:

- SOFT: Comfortable damping characteristic
- HARD: Sporty damping characteristic

To adjust spring preload:

- Start engine (▶▶▶ 89).
- Repeatedly press button **1** and hold until the setting you want to use appears on the display.



### NOTICE

You cannot adjust spring preload while the motorcycle is on the move.◀

The following settings are available:



One-up



One-up with luggage



Two-up (with luggage)

- Wait for the mechanism to complete all adjustments before you ride off.
- » The settings for damping and spring preload shown on the display are automatically accepted if you allow a certain length of time to pass without pressing button **1**. The ESA indicator flashes while adjustment is in progress.
- If the temperature is very low, take the weight off the motorcycle before increasing spring preload; if applicable, have your passenger dismount.

» The ESA indicator disappears from the display as soon as adjustment completes.

## Clutch

### Adjusting the clutch lever



#### WARNING

#### Adjusting the clutch lever while riding.

Risk of accident

- Do not attempt to adjust the clutch lever unless the motorcycle is at a standstill.◀

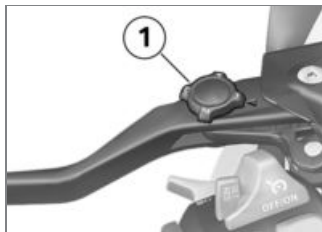

- Turn knob **1** to the desired position.



#### NOTICE

The adjuster is easier to turn if you push the clutch lever forward.◀

- » Four settings are possible:
  - Position 1: smallest span between handlebar grip and clutch lever
  - Position 4: largest span between handlebar grip and clutch lever

## Brakes

### Adjusting the front brake lever

#### WARNING

#### Adjusting the brake lever while riding.

Risk of accident

- Do not attempt to adjust the brake lever unless the motorcycle is at a standstill. ◀

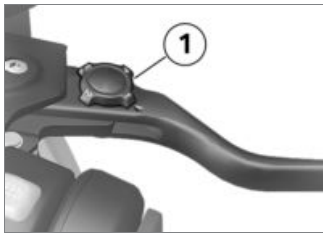

- Turn knob **1** to the desired position.



#### NOTICE

The adjuster is easier to turn if you push the brake lever forward. ◀

- » Four settings are possible:
- Position 1: smallest span between handlebar grip and brake lever
  - Position 4: largest span between handlebar grip and brake lever

## Tyres

### Checking tyre pressure



#### WARNING

#### Incorrect tyre pressure.

Impairment of the motorcycle's handling characteristics. Shorter useful tyre life.

- Always check that the tyre pressures are correct. ◀



#### WARNING

#### Tendency of valve inserts installed vertically top open by themselves at high riding speeds.

Sudden loss of tyre pressure.

- Install valve caps fitted with rubber sealing rings and tighten firmly. ◀
- Make sure the ground is level and firm and place the motorcycle on its stand.
- Check tyre pressures against the data below.



Tyre pressure, front

2.5 bar (tyre cold)



Tyre pressure, rear

2.9 bar (tyre cold)



If tyre pressure is too low:

- Correct tyre pressure.

## Handlebars

### Adjustable handlebars

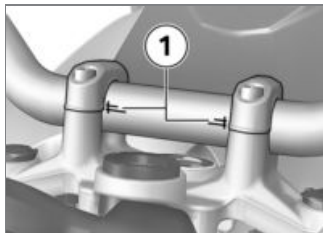

The motor cycle handlebars can be adjusted in their tilt within the ranges of marking **1**. If you want to have the handlebars adjusted consult a specialist workshop, preferably an authorised BMW Motorrad dealer.

## Heated handlebar grips

– with heated handlebar grips<sup>OE</sup>

### Operating the heated handlebar grips

#### NOTICE

The heating in the heated handlebar grips can be activated only when the engine is running.◀

#### NOTICE

The increase in power consumption caused by having the heated handlebar grips switched on can drain the battery if you are riding at low engine speeds. If the charge level is low, the heated handlebar grips are switched off to ensure the battery's starting capability.◀

- Start engine (▶▶▶ 89).



- Repeatedly press button **1** until desired heating stage **2** appears on the display.

The handlebar grips have two-stage heating.

 50% heating power

 100% heating power

- » Stage 2 is for heating the grips quickly: it is advisable to switch back to stage 1 as soon as the grips are warm.
- » The selected heating stage will be saved if you allow a certain

length of time to pass without making further changes.

- In order to switch off the heated handlebar grips, repeatedly press button **1** until the heated handlebar grip symbol **2** is no longer shown on the display.

## Mirrors

### Adjusting mirrors



- Turn the mirror to the correct position.

### Adjusting mirror arm

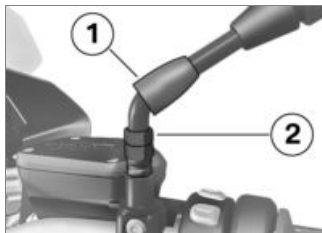

- Push protective cap **1** up over the threaded fastener on the mirror arm.
- Slacken nut **2**.
- Turn the mirror arm to the appropriate position.
- Tighten the nut to the specified tightening torque, while holding the mirror arm to ensure that it does not move out of position.



Mirror (lock nut) to adapter

22 Nm

- Push protective cap **1** over the threaded fastener.

## Windscreen

### Adjusting windscreen

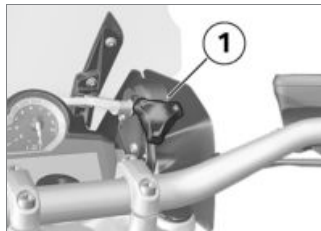

**WARNING**

### Adjusting the windscreen while riding.

Risk of falling

- Do not attempt to adjust the windscreen unless the motorcycle is at a standstill. ◀
- Turn knob **1** clockwise to lower the windscreen.

- Turn knob **1** counter-clockwise to raise the windscreen.

## Front and rear seats

### Removing rear seat

- Make sure the ground is level and firm and place the motorcycle on its stand.



- Turn the key clockwise in seat lock **1** and hold it in this position while pressing down the rear part of rear seat **2**.
- Lift the rear seat at the front and release the key.

- Remove the rear seat and place it, upholstered side down, on a clean surface.

### Install the rear seat

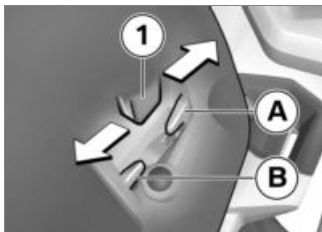

- The rear seat can be set to either of 2 different positions.
  - Bear in mind the position of the front seat with regard to the direction for adjustment of the rear seat:
  - Centre both lugs **1** on the rear seat in the mounts.
- High seat position: Push passenger seat to the rear **A**.

- Low seat position: Push rear seat forward **B**.
- » Lugs **1** of the rear seat are correctly located.



- Firmly press down on front seat **1** at the front.
- » The rear seat engages with an audible click.

### Removing front seat

- Removing rear seat (➡ 81).

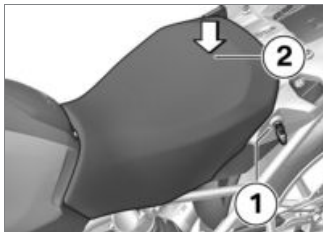

- Use vehicle key to turn seat lock **1** to the left and hold, supportingly press down the rider's seat in the rear area **2**.
- Lift the front seat at the rear and release the key.
- Remove the front seat and place it, upholstered side down, on a clean surface.

### Adjusting height and angle of tilt of front seat

- Remove front seat (▶▶▶ 81).

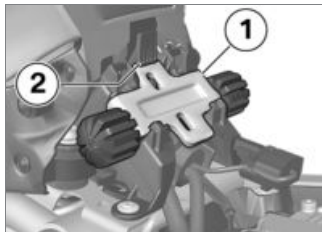

- In order to remove the front height adjustment **1**, press down locking mechanism **2** and remove height adjustment in an upward direction.

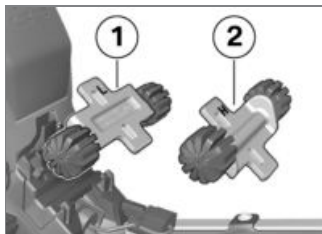

- In order to set the low seat position, install front height ad-

justment in the alignment **1** (identification L).

- In order to set the high seat position, install front height adjustment in the direction **2** (identification H).

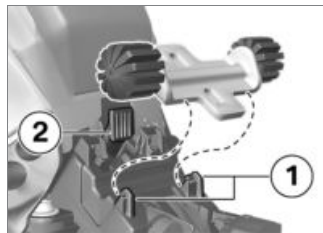

- Initially push front height adjustment under the mountings **1**, subsequently press into the locking mechanism **2** until the same engages.

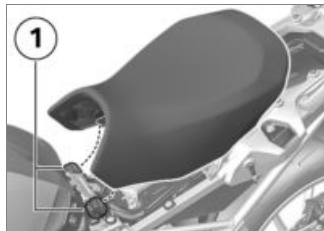
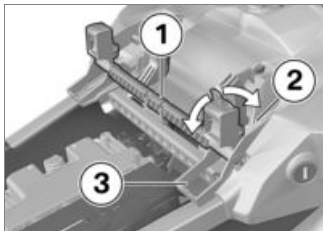

- In order to set the low seat position, swivel rear height adjustment **1** into position **3** (identification L).
  - In order to set the high seat position, swivel rear height adjustment **1** into position **2** (identification H).
- If the seat tilt is to be changed:
- Position front and rear height adjustment differently.

### Installing front seat

- Removing rear seat (▣▣▣▶ 81).
- Adjust the height and angle of tilt of front seat (▣▣▣▶ 82).

- Set rider's seat into the mountings **1** left and right, and place loosely on the motorcycle.
- Press the rider's seat slightly forward in its rear area and then firmly down until the locking mechanism engages.



## **Riding**

Safety instructions .....	86
Comply with checklist.....	89
Starting .....	89
Running in .....	91
Shifting gear .....	92
Brakes .....	93
Parking your motorcycle .....	95
Off-roading .....	96
Refuelling .....	97
Securing motorcycle for transportation .....	101

## Safety instructions

### Rider's equipment

Do not ride without the correct clothing! Always wear:

- Helmet
- Motorcycling jacket and trousers
- Gloves
- Boots

This applies even to short journeys, and to every season of the year. Your authorised BMW Motorrad dealer will be glad to advise you on the correct clothing for every purpose.

### Restricted angle of heel

- with lowered suspension<sup>OE</sup>

A motorcycle with lowered suspension has less ground clearance and cannot corner at angles of heel as extreme as those achievable by a

counterpart motorcycle with standard-height suspension.



### WARNING

**When a motorcycle with lowered suspension is cornering, certain components can come into contact with the surface at a bank angle less than that to which the rider is accustomed.**

Risk of falling

- Carefully try out the limits of the motorcycle's bank angle and adapt your style of riding accordingly.◀

Test your motorcycle's angle of heel in situations that do not involve risk. When riding over kerbs and similar obstacles, bear in mind that your motorcycle's ground clearance is limited.

Lowering the motorcycle's suspension shortens suspension travel (see the section entitled "Technical Data"). Ride comfort might be restricted as a result. Be sure to adjust spring preload accordingly, particularly for riding two-up.

### Loading



### WARNING

**Handling adversely affected by overloading and imbalanced loads.**

Risk of falling

- Do not exceed the permissible gross weight and be sure to comply with the instructions on loading.◀
- Adjusting spring preload setting and damping to the total weight.



- with cases<sup>OA</sup>
  - Ensure that the case volumes on the left and right are equal.
  - Make sure that the weight is uniformly distributed between right and left.
  - Pack heavy items at the bottom and toward the inboard side.
  - Note the maximum permissible payload and the speed limit for riding with cases fitted, as stated on the label inside the case (see also the section entitled "Accessories").<
- with topcase<sup>OA</sup>
  - Note the maximum permissible payload and the speed limit for riding with topcase fitted, as stated on the label inside the case (see also the section entitled "Accessories").<

- with tank rucksack<sup>OA</sup>
  - Note the maximum permissible payload of the tank rucksack.

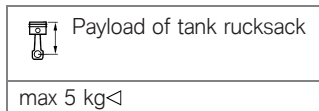

## Speed

If you ride at high speed, always bear in mind that various boundary conditions can adversely affect the handling of your motorcycle:

- Settings of the spring-strut and shock-absorber system
- Imbalanced load
- Loose clothing
- Insufficient tyre pressure
- Poor tyre tread
- Etc.

## Maximum speed with knobbly tyres or winter tyres



### Top speed of the motorcycle higher than the permissible maximum rated speed of the tyres.

Risk of accident due to tyre damage at high speed.

- Comply with the tyre-specific speed restrictions.◀

Always bear the maximum permissible speed of the tyres in mind when riding a motorcycle fitted with knobbly tyres or winter tyres.

Affix a label stating the maximum permissible speed to the instrument panel in the rider's field of vision.

## Risk of poisoning

Exhaust fumes contain carbon monoxide, which is colourless and odourless but highly toxic.



### WARNING

#### Exhaust gases adversely affecting health.

Risk of asphyxiation

- Do not inhale exhaust fumes.
- Do not run the engine in an enclosed space.◀

## Risk of burn injury



### CAUTION

#### Engine and exhaust system become very hot when the vehicle is in use.

Risk of burn injury

- When you park the vehicle make sure that no-one and no objects can come into contact with the hot engine and exhaust system.◀

## Catalytic converter

If misfiring causes unburned fuel to enter the catalytic converter, there is a danger of overheating and damage.

For this reason, observe the following points:

- Do not run the fuel tank dry
- Do not attempt to start or run the engine with a spark-plug cap disconnected
- Stop the engine immediately if it misfires
- Use only unleaded fuel
- Comply with all specified maintenance intervals.



### ATTENTION

#### Unburned fuel in catalytic converter.

Damage to catalytic converter.

- Note the points listed for protection of the catalytic converter.◀

## Risk of overheating



### ATTENTION

#### Engine running for prolonged period with vehicle at standstill.

Overheating due to insufficient cooling. In extreme cases, the motorcycle could catch fire.

- Do not allow the engine to idle unnecessarily.
- Ride away immediately after starting the engine.◀

## Tampering



### ATTENTION

#### Tampering with the motorcycle (e.g. engine management ECU, throttle valves, clutch).

Damage to the affected parts, failure of safety-relevant functions. Damage due to tampering is not covered by the warranty.

- Do not tamper with the vehicle in any way that could result in tuned performance. ◀

## Comply with checklist

- At regular intervals, use the checklist below to check your motorcycle.

### Always before riding off:

- Operation of the brake system
- Operation of the lights and signalling equipment
- Checking clutch function (▣▣▣ 124).
- Checking tyre tread depth (▣▣▣ 124).
- Cases correctly installed and luggage secured

### Every 3rd refuelling stop:

- without Dynamic ESA<sup>OE</sup>
- Adjusting spring preload for rear wheel (▣▣▣ 73). ◀

- without Dynamic ESA<sup>OE</sup>
- Adjust the damping for rear wheel (▣▣▣ 74). ◀

- with Dynamic ESA<sup>OE</sup>
- Adjusting the chassis and suspension (▣▣▣ 76). ◀

- Check engine oil level (▣▣▣ 117).
- Checking front brake pad thickness (▣▣▣ 118).
- Check the rear brake pad thickness (▣▣▣ 119).
- Check brake-fluid level, front brakes (▣▣▣ 120).
- Check the brake-fluid level, rear brakes (▣▣▣ 121).
- Check coolant level (▣▣▣ 122).

## Starting

### Start engine

- Switch on the ignition.
- » Pre-Ride-Check is performed (▣▣▣ 90)

- » ABS self-diagnosis is performed (▣▣▣ 90)
- » ASC self-diagnosis is performed (▣▣▣ 91)
- Select neutral or, if a gear is engaged, pull the clutch lever.



### NOTICE

You cannot start the motorcycle with the side stand extended and a gear engaged. The engine will switch itself off if you start it with the gearbox in neutral and then engage a gear before retracting the side stand. ◀

- For a cold engine start and low temperatures: pull clutch.



- Press starter button **1**.

#### NOTICE

The start attempt is automatically interrupted if battery voltage is too low. Recharge the battery before you start the engine, or use jump leads and a donor battery to start.

See the subsection on jump starting in "Maintenance" for more details. ◀

- » The engine starts.
- » If the engine refuses to start, consult the troubleshooting

chart in the section entitled "Technical data" (▶▶▶ 168)

### Pre-ride check

The instrument cluster runs a test of the instruments and the warning lights and telltale lights and the display when the ignition is switched on. This test is known as the Pre-Ride-Check. The test is aborted if you start the engine before it completes.

#### Phase 1

All warning and indicator lights are switched on.

#### Phase 2

The 'General' warning light changes from red to yellow.

#### Phase 3

All the warning lights and telltale lights switched on in the initial phase are switched off in reverse sequence.

If a warning light or a telltale light did not show:

- Have the fault rectified as quickly as possible by a specialist workshop, preferably an authorised BMW Motorrad dealer.

### ABS self-diagnosis

BMW Motorrad Integral ABS performs self-diagnosis to ensure its operability. Self-diagnosis is performed automatically when you switch on the ignition. The motorcycle has to move forward a few metres (at a speed of at least 5 km/h) for the wheel-speed sensors to be tested.

#### Phase 1

- » Test of the diagnosable system components with the vehicle at a standstill.



ABS warning light flashes.

## Phase 2

- » Test of the wheel-speed sensors as the vehicle pulls away from rest.



ABS warning light flashes.

## ABS self-diagnosis completed

- » The ABS warning light goes out.
  - Check all the warning and tell-tale lights.
- After the ABS self-diagnosis completes, an indicator showing an ABS fault will appear.
- You can continue to ride. Bear in mind that neither the ABS function nor the integral braking function is available.
  - Have the fault rectified as quickly as possible by a specialist workshop, preferably an authorised BMW Motorrad dealer.

## ASC self-diagnosis

BMW Motorrad ASC performs self-diagnosis to ensure its operability. Self-diagnosis is performed automatically when you switch on the ignition.

## Phase 1

- » Test of the diagnosable system components with the vehicle at a standstill.



The ASC warning light slow-flashes.

## Phase 2

- » Test of the diagnosis-capable system components while the motorcycle is on the move (speed at least 5 km/h).



The ASC warning light slow-flashes.

## ASC self-diagnosis completed

- » The ASC warning light goes out.

- Check all the warning and tell-tale lights.

After completion of ASC self-diagnosis, an indicator showing an ASC fault is displayed:

- You can continue to ride. Bear in mind that the ASC function is not available.
- Have the fault rectified as quickly as possible by a specialist workshop, preferably an authorised BMW Motorrad dealer.

## Running in Engine

- Until the first running-in check, vary the throttle opening and engine-speed range frequently; avoid riding at constant engine rpm for prolonged periods.
- Try to do most of your riding during this initial period on twisting, fairly hilly roads.

- Comply with the rpm limits for running in.



Running-in speeds

<5000 min<sup>-1</sup> (Odometer reading 0...1000 km)

no full throttle (Odometer reading 0...1000 km)

- Note the mileage after which the running-in check should be carried out.



Mileage until the running-in check

500...1200 km

## Brake pads

New brake pads have to bed down before they can achieve their optimum friction levels. You can compensate for this initial reduction in braking efficiency by exerting greater pressure on the levers.



## WARNING

### New brake pads.

Longer stopping distance. Risk of accident.

- Apply the brakes in good time.◀

## Tyres

New tyres have a smooth surface. This must be roughened by riding in a restrained manner at various heel angles until the tyres are run in. This running in procedure is essential if the tyres are to achieve maximum grip.



## WARNING

### New tyres losing grip on wet roads and at extreme bank angles.

Risk of accident

- Ride carefully and avoid extremely sharp inclines.◀

## Shifting gear

– with Pro shift assistant<sup>OE</sup>

### Shift assistant Pro

The shift assistant assists upshifts and downshifts without the rider having to pull the clutch or close the throttle. This is not an automatic-shift system. The rider is the most important part of the system and decides when to shift gears.



## NOTICE

See the section entitled "Engineering details" for more information on the Pro shift assistant.◀



## NOTICE

Whenever the Pro shift assistant shifts gears, cruise control is automatically disengaged for safety reasons.◀

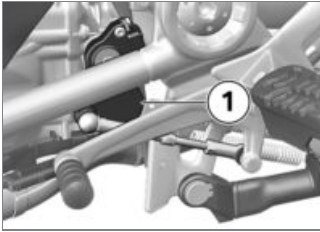

- You select the gear in the usual way by means of the foot-operated shift lever.
- » Sensor **1** on the selector shaft registers the shift request and triggers shift assistance.
- » When riding at a steady speed in a low gear at high engine rpm, an attempt to shift gear without pulling the clutch can cause a severe load-change reaction. BMW Motorrad recommends disengaging the clutch for shifts in these circumstances. It is advisable to avoid using the Pro shift assistant at engine speeds close to

the limits at which the governor cuts in to limit engine rpm.

- » Shift assistance is not available in the following situations:
  - with the clutch lever pulled
  - shift lever not in its initial position
  - upshifts with the throttle valve closed (coasting) and when slowing.
- After a gearshift, the shift lever has to be fully released before another gearshift with the Pro shift assistant can take place.

## Brakes

### How can stopping distance be minimised?

Each time the brakes are applied, a load distribution shift takes place with the load shifting forward from the rear to the front wheel. The sharper the motorcycle decelerates, the more load is shifted to the front wheel. The

higher the wheel load, the more braking force can be transmitted without the wheel locking. To optimise stopping distance, apply the front brakes rapidly and keep on increasing the force you apply to the brake lever. This makes the best possible use of the dynamic increase in load at the front wheel. Remember to pull the clutch at the same time. In the "panic braking situations" that are trained so frequently braking force is applied as rapidly as possible and with the rider's full force applied to the brake levers; under these circumstances the dynamic shift in load distribution cannot keep pace with the increase in deceleration and the tyres cannot transmit the full braking force to the surface of the road.

BMW Motorrad Integral ABS prevents the front wheel from locking up.

## Hazard braking

– with ABS Pro<sup>OE</sup>

If you brake sharply from a speed in excess of 50 km/h the brake light flashes rapidly as a warning for road users behind you.

If you brake until your speed is less than 15 km/h the hazard warning lights start to flash as well. The hazard warning lights switch off automatically as soon as you start to accelerate and vehicle speed reaches 20 km/h.

## Descending mountain passes

### WARNING

### Braking only with the rear brake on mountain descents.

Brake fade. Destruction of the brakes due to overheating.

- Use both front and rear brakes, and make use of the engine's braking effect as well.◀

## Wet and dirty brakes

Wetness and dirt on the brake discs and the brake pads diminish braking efficiency.

Delayed braking action or poor braking efficiency must be reckoned with in the following situations:

- Riding in the rain or through puddles of water.
- After the vehicle has been washed.
- Riding on salted or gritted roads.
- After work has been carried on the brakes, due to traces of oil or grease.
- Riding on dirt-covered surfaces or off-road.

### WARNING

### Moisture and dirt.

Diminished braking effect.

- Apply the brakes lightly while riding to remove wetness and

dirt, or dismount and clean the brakes.

- Think ahead and brake in good time until full braking efficiency is restored.◀

## ABS Pro

– with ABS Pro<sup>OE</sup>

## Physical limits applicable to motorcycling

### WARNING

### Braking when cornering.

Risk of crash despite ABS Pro

- Invariably, the rider bears responsibility for assessing road and traffic conditions and adopting his or her style of riding accordingly.
- Do not take risks that would negate the additional safety offered by this system.◀

ABS Pro is available in all riding modes except Enduro Pro. As-



sistance varies, depending on the riding mode selected and decreases in 3 stages from RAIN to Enduro.

### **Assistance by ABS Pro**

- RAIN and ROAD: Maximum assistance.
- DYNAMIC: Slightly reduced assistance.
- Enduro: Slight assistance.
- Enduro Pro: ABS Pro inactive.

### **Possibility of a fall not precluded**

Although ABS Pro provides the rider with valuable assistance and constitutes a huge advance in safety for braking with the motorcycle banked for cornering, it cannot under any circumstances be considered as redefining the physical limits that apply to motorcycling. It is still possible for these limits to be overshoot due to misjudgement or rider error. In

extreme cases this can result in a crash.

### **Use on public roads**

ABS Pro helps make the motorcycle even safer for riding on public roads. When the brakes are applied because of an unforeseen hazard when the motorcycle is banked for cornering, within the physical limits that apply to motorcycling the system prevents the wheels from locking and skidding away.

### **NOTICE**

ABS Pro was not developed to enhance individual braking performance with the motorcycle banked into corners in situations approaching the limits of performance. ◀

## **Parking your motorcycle**

### **Side stand**

- Switch off the engine.

### **ATTENTION**

#### **Poor ground underneath the stand.**

Risk of damage to parts if vehicle topples.

- Always check that the ground under the stand is level and firm. ◀

### **ATTENTION**

#### **Additional weight placing strain on the side stand.**

Risk of damage to parts if vehicle topples.

- Do not sit or lean on the vehicle while it is propped on the side stand. ◀

- Extend the side stand and prop the motorcycle on the stand.
- If the camber of the roadway permits, turn the handlebars all the way to the left.
- On a gradient, the motorcycle should always face uphill; select 1st gear.

### Centre stand

- Switch off the engine.



#### ATTENTION

#### Poor ground underneath the stand.

Risk of damage to parts if vehicle topples.

- Always check that the ground under the stand is level and firm. ◀



#### ATTENTION

#### Centre stand retracts due to severe movements.

Risk of damage to parts if vehicle topples.

- Do not lean or sit on the vehicle with the centre stand extended. ◀
- Extend the centre stand and lift the motorcycle onto the stand.
- On a gradient, the motorcycle should always face uphill; select 1st gear.

### Off-roading

#### For off-roading Rims



#### ATTENTION

#### Off-roading more severe than riding on unsurfaced tracks.

Damage to standard cast-aluminium rims.

- Use the cross-spoked wheels available as optional extras for severe off-roading. ◀

### After off-roading

BMW Motorrad recommends checking the following after riding the motorcycle off-road:

#### Tyre pressure



#### WARNING

#### Riding on surfaced roads with tyre pressures lowered for off-roading.

Risk of accident due to impaired handling characteristics.

- Always check that the tyre pressures are correct. ◀

#### Brakes



#### WARNING

#### Riding on unsurfaced roads or dirty road surfaces.

Delayed braking effect due to dirty brake discs and brake pads.

- Apply the brakes in good time until the brakes have been cleaned. ◀



## ATTENTION

### Riding on unsurfaced roads or dirty road surfaces.

Increased brake-pad wear.

- Check the thickness of the brake pads more frequently and replace the brake pads in good time. ◀

### Spring preload and shock-absorber settings



## WARNING

### Changed values for spring preload and spring-strut damping for riding off-road.

Impaired handling characteristics on surfaced roads.

- If you have been off-roading, be sure to correct spring preload and spring-strut damping

characteristics before you return to surfaced roads. ◀

### Rims

BMW Motorrad recommends checking the rims for damage after off-roading.

### Air filter element



## ATTENTION

### Dirty air-filter element.

Engine damage

- If you ride in dusty terrain check the air filter element for clogging at shorter intervals; clean or replace as necessary. ◀

Operation in very dusty conditions (desert, steppes, or the like) necessitates the use of air filter elements specially designed for conditions of this nature.

## Refuelling

### Fuel grade

For optimum fuel consumption, fuel should be sulphur-free or as low-sulphur as possible.



## ATTENTION

### Leaded fuel.

Damage to catalytic converter.

- Do not attempt to run the vehicle on leaded fuel or fuel with metallic additives, e.g. manganese or iron. ◀
- Fuels with a maximum Ethanol content of 10 %, i.e. E10, can be fuelled.



Recommended fuel grade

Super unleaded (max. 10 % ethanol, E10)  
95 ROZ/RON  
89 AKI



Alternative fuel grade

Regular unleaded (Power- and consumption-related restrictions. If e.g. the engine is to be operated in countries with low fuel grades at 91 research octane number, then the motorcycle must first be programmed appropriately at your authorised BMW motorcycle dealer.) (max. 10 % ethanol, E10)  
91 ROZ/RON  
87 AKI

## Refuelling



### WARNING

#### Fuel is highly flammable.

Risk of fire and explosion.

- Do not smoke. Never bring a naked flame near the fuel tank. ◀



### WARNING

#### Escape of fuel due to heat-induced expansion if fuel tank is overfilled.

Risk of falling

- Do not overfill the fuel tank. ◀



### ATTENTION

#### Fuel attacks plastic surfaces.

Surfaces become unsightly or dull.

- Clean plastic parts immediately after contact with fuel. ◀
- Make sure the ground is level and firm and place the motorcycle on its centre stand.

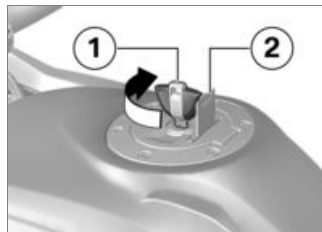

- Open the protective cap **2**.
- Use ignition key **1** to unlock fuel filler cap by turning it clockwise, and flip the cap open.



- Do not fill the tank past the bottom edge of the filler neck.

#### NOTICE

If filling occurs after the fuel level has gone below the reserve limit, the amount filled must be greater than the reserve amount for the new fuel level to be recognised and the warning light to switch off. ◀

#### NOTICE

The “usable fuel capacity” specified in the technical data is the quantity that the fuel tank could

hold if it had been run dry and the engine had cut out due to a lack of fuel. ◀



Usable fuel capacity

approx. 20 l



Reserve fuel

approx. 4 l

- Press the fuel tank cap down firmly to close.
- Remove the ignition key and close the protective cap.

### Refuelling

– with Keyless Ride<sup>OE</sup>

The steering lock is disengaged.



#### WARNING

**Fuel is highly flammable.**

Risk of fire and explosion.

- Do not smoke. Never bring a naked flame near the fuel tank. ◀



#### WARNING

**Escape of fuel due to heat-induced expansion if fuel tank is overfilled.**

Risk of falling

- Do not overfill the fuel tank. ◀



#### ATTENTION

**Fuel attacks plastic surfaces.**

Surfaces become unsightly or dull.

- Clean plastic parts immediately after contact with fuel. ◀
- Make sure the ground is level and firm and place the motorcycle on its centre stand.  
– with Keyless Ride<sup>OE</sup>
- Switching off ignition (☰ 48).



## NOTICE

The fuel filler cap can be opened within the defined waiting time after the ignition has been switched off, without the radio-operated key being within range. ◀



Waiting time for opening fuel filler cap

2 min

- » There are **two variant ways** of opening the fuel filler cap:
- Within the waiting time
  - After the waiting time has expired

### Version 1

- with Keyless Ride<sup>OE</sup>

Within the waiting time



- Pull up tab **1** of the fuel filler cap slowly.
- » Fuel filler cap unlocks.
- Fully open the fuel filler cap.

### Version 2

- with Keyless Ride<sup>OE</sup>

After the waiting time has expired

- Bring the radio-operated key into range.
- Slowly pull tab **1** up.
- » The telltale light for the radio-operated key flashes while the search for the radio-operated key is in progress.

- Again slowly pull up tab **1** of the fuel filler cap.
- » Fuel filler cap unlocks.
- Fully open the fuel filler cap.



- Refuel with fuel of the grade stated above; do not fill the tank past the bottom edge of the filler neck.



## NOTICE

If filling occurs after the fuel level has gone below the reserve limit, the amount filled must be greater than the reserve amount for the new fuel level to be recognised

and the warning light to switch off. ◀

## NOTICE

The “usable fuel capacity” specified in the technical data is the quantity that the fuel tank could hold if it had been run dry and the engine had cut out due to a lack of fuel. ◀

 Usable fuel capacity

approx. 20 l

 Reserve fuel

approx. 4 l

- Press down firmly on the filler cap of the fuel tank.
- » The fuel filler cap engages with an audible click.

- » The fuel filler cap locks automatically when the waiting time expires.
- » The engaged fuel filler cap locks immediately when you secure the steering lock or switch on the ignition.

## Securing motorcycle for transportation

- Make sure that all components that might come into contact with straps used to secure the motorcycle are adequately protected against scratching. Use adhesive tape or soft cloths, for example, for this purpose.



## ATTENTION

### Vehicle topples to side when being lifted on to stand.

Risk of damage to parts if vehicle topples.

- Secure the vehicle to prevent it toppling, preferably with the assistance of a second person. ◀
- Push the motorcycle onto the transportation flat and hold it in position: do not place it on the side stand or centre stand.

**ATTENTION****Trapping of components.**

Component damage

- Do not trap components such as brake lines or cable legs. ◀
- At the front, secure the straps to the handlebars on both sides.
- Pass the straps through the leading link and tighten the straps.



- At the rear, secure the straps to the rear footrests on both sides and tighten the straps.
- Tighten all the straps uniformly; the motorcycle's suspension should be compressed as tightly as possible front and rear.



## Engineering details

Riding mode .....	104
Shift assistant.....	105
Brake system with BMW Motorrad Integral ABS .....	106
Electronic engine management with BMW Motorrad ASC.....	110
Tyre pressure monitoring RDC ....	112

## Riding mode

### Selection

There is a choice of 5 riding modes for adapting the motor-cycle to riding-surface condition:

- RAIN
- ROAD (Standard mode)
- with Pro riding modes<sup>OE</sup>
- DYNAMIC
- Enduro
- Enduro Pro (only if coding plug fitted)

For each of the 5 riding modes there is a matching setting for the ABS and ASC systems and for throttle response.

- with Dynamic ESA<sup>OE</sup>

The adjustment of the Dynamic ESA also depends on the riding mode selected.

ABS and/or ASC can be switched off in each mode: the explanations below invariably apply to the behaviour of the motorcycle with these systems active.

### Throttle response

- In the RAIN and Enduro modes: Restrained
- In the ROAD and Enduro Pro modes: Direct
- In the DYNAMIC mode: Dynamic

### ABS

- The rear wheel lift assistant is active in all modes.
- In the RAIN, ROAD and DYNAMIC modes, the ABS is adjusted to road operation.
- In the Enduro mode, the ABS is adjusted to off-road operation using road tyres.
- In the Enduro Pro mode, there will be no ABS control at the

rear wheel when the footbrake lever is operated. The ABS has been adjusted to off-road operation using studded tyres.

- with ABS Pro<sup>OE</sup>
- In the RAIN and ROAD modes, ABS Pro is fully available. The tendency of the motorcycle to straighten up when the brakes are applied with the machine banked for cornering is reduced to a minimum.
- In the DYNAMIC mode, ABS Pro is available. Assistance is less than in the ROAD riding mode.
- In Enduro mode, ABS Pro is available only to a restricted extent.
- In Enduro Pro mode, ABS Pro is inactive.

## ASC

- The front wheel lift assistant is active in all modes.
- In the RAIN, ROAD and DYNAMIC modes, the ASC is set up for road riding.
- In the Enduro and Enduro Pro modes, the ASC is set up for off-road riding.
- with Dynamic ESA<sup>OE</sup>

## Dynamic ESA

- In the RAIN, ROAD and DYNAMIC modes, the damping variants HARD, NORMAL and SOFT can be selected.
- Basic setting RAIN: SOFT
- Basic setting ROAD: NORMAL
- Basic setting DYNAMIC: HARD
- In the Enduro and Enduro Pro modes, the damping variants HARD and SOFT can be selected.
- Basic setting Enduro: SOFT

- Basic setting Enduro Pro: HARD

## Mode changes

- with Pro riding modes<sup>OE</sup>

When riding, you can change riding modes only when the following preconditions are satisfied:

- No drive torque at the rear wheel
- No brake pressure in the brake system.

This is the status of the motorcycle when it is at a standstill with the ignition switched on. Under other circumstances, you must proceed as follows:

- Close the throttle twistgrip
- Release the brake levers
- Disengage the clutch.

The desired riding mode is initially preselected. The mode change does not take place until

the systems in question are all in the appropriate state.

The selection menu does not disappear from the display until the mode change has taken place.

## Shift assistant

- with Pro shift assistant<sup>OE</sup>

## Shift assistant Pro

Your vehicle is equipped with a Pro shift assistant, a system originally developed for racing and now adapted for the touring sector. It permits upshifts and downshifts without declutching or closing the throttle in virtually all load and rpm ranges.

## Advantages

- 70-80 % of all gearshifts on a trip can be done without using the clutch.
- Less relative movement between rider and passenger

because the shift pauses are shorter.

- It is not necessary to close the throttle valve when shifting under acceleration.
- When braking and downshifting (throttle valve closed), engine speed is adjusted by blipping the throttle.
- Shift time is shorter than a gearshift with clutch actuation.

In order for the system to identify a request for a gearshift, the rider has to move the shift lever from its idle position in the desired direction against the force of the spring through a certain "over-travel" at ordinary speed or rapidly and keep the shift lever in this position until the gearshift is completed. It is not necessary to increase the force applied to the shift lever while shifting is in progress. Once the gearshift has completed the shift lever has

to be fully released before another gearshift with the Pro shift assistant can take place. When shifting gears with the Pro shift assistant, the rider has to keep load state (throttle twistgrip position) constant before and during the gearshift. A change in the position of the throttle twistgrip during a gearshift can cause the function to abort and/or lead to a missed shift. The Pro shift assistant provides no assistance for the gearshift if the rider de-clutches.

### Downshifting

- Downshifting is assisted until maximum rpm for the target gear to be selected is reached. This prevents overrevving.



Maximum engine speed

max 9000 min<sup>-1</sup>

### Upshifting

- The Pro shift assistant provides no assistance if engine speed drops below idle during an up-shift.



Idle speed

1150 min<sup>-1</sup> (Engine at regular operating temperature)

## Brake system with BMW Motorrad Integral ABS

### Partially integral brakes

Your motorcycle is equipped with partially integral brakes. Both front and rear brakes are applied when you pull the handbrake lever. The footbrake lever acts only on the rear brake. While the brakes are slowing the motorcycle with ABS actively in-

tervening, the BMW Motorrad Integral ABS adapts braking-force distribution between front and rear brakes to suit the load on the motorcycle.



## ATTENTION

**The integral function means that it is not possible to make the rear wheel spin with the front brake applied (Burn Out).**

Damage to rear brake and clutch.

- Do not attempt Burn Out. ◀

## How does ABS work?

The amount of braking force that can be transferred to the road depends on factors that include the coefficient of friction of the road surface. Loose stones, ice and snow or a wet road all have much lower coefficients of friction than a clean and dry asphalt surface. The lower the coefficient

of friction, the longer the braking distance.

If the rider increases braking pressure to the extent that braking force exceeds the maximum transferable limit, the wheels start to lock and the vehicle loses its directional stability; a fall is imminent. Before this situation occurs the ABS will be activated and the brake pressure adapted to the maximally transferable braking force. The wheels continue to turn and the driving stability is retained irrespective of the road condition.

## What are the effects of surface irregularities?

Humps and surface irregularities can cause the wheels to lose contact temporarily with the road surface; if this happens the braking force that can be transmitted to the road can drop to zero. If the brakes are applied

under these circumstances the ABS has to reduce braking force to ensure that directional stability is maintained when the wheels regain contact with the road surface. At this instant the BMW Motorrad Integral ABS must assume an extremely low coefficient of friction, so that the wheels will continue to rotate under all imaginable circumstances, because this is the precondition for ensuring directional stability. As soon as it registers the actual circumstances, the system reacts instantly and adjusts braking force accordingly to achieve optimum braking.

## What feedback does the rider receive from the BMW Motorrad Integral ABS?

If the ABS system has to reduce braking force on account of the circumstances described above, vibration is perceptible through the handbrake lever.

When the handbrake lever is pulled, brake pressure is also built up at the rear wheel by the integral function. If the brake pedal is depressed after the handbrake lever is pulled, the brake pressure built up beforehand is perceptible as counter-pressure sooner than is the case when the brake pedal is depressed either before or at the same time as the brake lever is pulled.

## Rear wheel lift

Under very severe and sudden deceleration, however, under certain circumstances it is possible that the BMW Motorrad Integral ABS will be unable to prevent the rear wheel from lifting clear of the ground. If this happens the outcome can be a highsiding situation in which the motorcycle can flip over.



### WARNING

#### Rear wheel lift due to severe braking.

Risk of falling

- When you brake sharply, bear in mind that ABS control cannot always be relied on to prevent the rear wheel from lifting clear of the ground. ◀

## What is the design baseline for BMW Motorrad Integral ABS?

Within the limits imposed by physics, the BMW Motorrad Integral ABS ensures directional stability on any surface. The system is not optimised for special requirements that apply under extreme competitive situations off-road or on the track. The driving behaviour should be adapted to actual driving skills and the road conditions.

### Special situations

The speeds of the front and rear wheels are compared as one means of detecting a wheel's incipient tendency to lock. If the system registers implausible values for a lengthy period, the ABS function is deactivated for safety reasons and an ABS fault message is issued. Self-dia-

gnosis has to complete before fault messages can be issued. In addition to problems with the BMW Motorrad Integral ABS, exceptional riding conditions can lead to a fault message being issued:

- Heating up with the motorcycle on the centre stand or an auxiliary stand, engine idling or with a gear engaged
- Rear wheel locked by the engine brake for a lengthy period, for example while descending on a loose or slippery surface.

If a fault message is issued on account of exceptional riding conditions, you can reactivate the ABS function by switching the ignition off and on again.

## What significance devolves on regular maintenance?

### WARNING

#### Brake system not regularly serviced.

Risk of accident

- In order to ensure that the ABS is always maintained in optimum condition, it is essential for you to comply strictly with the specified inspection intervals.◀

#### Reserves for safety

The potentially shorter braking distances which BMW Motorrad Integral ABS permits must not be used as an excuse for careless riding. ABS is primarily a means of ensuring a safety margin in genuine emergencies.

### WARNING

#### Braking when cornering.

Risk of accident despite ABS.

- Invariably, the rider bears responsibility for assessing road and traffic conditions and adopting his or her style of riding accordingly.
- Do not take risks that would negate the additional margin of safety offered by this system.◀

#### Evolution of ABS to ABS Pro

– with ABS Pro<sup>OE</sup>

Until now, the BMW Motorrad ABS helped ensure a very high degree of safety for braking with the motorcycle upright and travelling in a straight line. Now ABS Pro offers enhanced safety for braking in corners as well. ABS Pro prevents the wheels from locking even under

sharp braking. ABS Pro reduces abrupt changes in steering force, particularly in panic-braking situations, counteracting the vehicle's otherwise natural but undesirable tendency to straighten up.

### **ABS intervention**

Technically speaking, depending on the riding situation ABS Pro adapts ABS intervention to the motorcycle's bank angle. Signals for rate of roll and rate of yaw and lateral acceleration are used to calculate bank angle.

As the motorcycle is heeled over more and more as it banks into a corner, an increasingly strict limit is imposed on the brake-pressure gradient for the start of brake application. This slows the build-up of brake pressure to a corresponding degree. Additionally, pressure modulation is more

uniform across the range of ABS intervention.

### **Advantages for the rider**

The advantages of ABS Pro for the rider are sensitive response and high braking and directional stability combined with best-case deceleration of the motorcycle, even when cornering.

## **Electronic engine management with BMW Motorrad ASC**

### **How does ASC work?**

BMW Motorrad ASC compares the speed of rotation of the front wheel and the rear wheel. The differential is used to compute slip as a measure of the reserves of stability available at the rear wheel. If slip exceeds a certain limit, the engine control intervenes and adapts the engine torque accordingly.

## **What is the design baseline for BMW Motorrad ASC?**

BMW Motorrad ASC is designed as an assistant system for the rider and for use on public roads. The extent to which the rider affects ASC control can be considerable (weight shifts when cornering, items of luggage loose on the motorcycle), especially when style of riding takes rider and machine close to the limits imposed by physics.

Activate the Enduro mode for off-roading. This mode delays ASC intervention slightly in order to permit controlled drifting. The system is not optimised for special requirements that apply under extreme competitive situations off-road or on the track. The BMW Motorrad ASC can be deactivated in these cases.



## **WARNING**

### **Risky riding.**

Risk of accident despite ASC.

- Invariably, it remains the rider's responsibility to adapt riding style to riding conditions.
- Do not take risks that would negate the additional safety offered by this system. ◀

### **Special situations**

In accordance with the laws of physics, the ability to accelerate is restricted more and more as the angle of heel increases. Consequently, there can be a perceptible lag in acceleration out of very tight bends.

The speeds of the front and rear wheels are compared as one means of detecting the rear wheel's incipient tendency to spin or slip sideways. If the system registers implausible values

for a lengthy period, the ASC function is deactivated for safety reasons and an ASC fault message is issued. Self-diagnosis has to complete before fault messages can be issued.

The following exceptional riding conditions can lead to an automatic shutdown of the BMW Motorrad ASC:

- Riding for a lengthy period with the rear wheel lifted off the ground (wheelie) with ASC deactivated
- Rear wheel rotating with the vehicle held stationary by applying the front brake (burn-out)
- Heating up with the motorcycle on the centre stand or an auxiliary stand, engine idling or with a gear engaged

Accelerating the motorcycle to a speed in excess of 10 km/h after switching the ignition off and then on again reactivates the ASC.

Slip can be increased by very-heavy-duty massive-bar tyres, with the result that ASC intervention occurs before optimum forward acceleration is achieved. Under these circumstances, BMW Motorrad ASC should be deactivated.

If the front wheel lifts clear of the ground under severe acceleration, ASC reduces engine torque until the front wheel regains contact with the ground. Under these circumstances, BMW Motorrad recommends rolling the throttle slightly closed so as to restore stability with the least possible delay.

When riding on a slippery surface, never snap the throttle twistgrip fully closed without pulling the clutch at the same time. Engine braking torque can cause the rear wheel to lock, with a corresponding loss of stability. BMW Motorrad ASC is unable to control a situation of this nature.

## Tyre pressure monitoring RDC

– with tyre pressure monitoring (RDC)<sup>OE</sup>

### Function

A sensor integrated into each tyre measures the air temperature and the air pressure inside the tyre and transmits this information to the control unit. Each sensor has a centrifugal-force tripswitch that does not enable transmission of the measured values until the motorcycle has accelerated to above approx-

imately 30 km/h for the first time. The display shows -- for each tyre until the tyre-pressure signal is received for the first time. The sensors continue to transmit the measured-value signals for approximately 15 minutes after the vehicle comes to a stop.

An error message is issued if wheels without sensors are fitted to a vehicle equipped with an RDC control unit.

### Tyre-pressure ranges

The control unit differentiates between 3 tyre-pressure ranges, all of which are parameterised for the motorcycle:

- Tyre pressure within permitted tolerance
- Tyre pressure close to limit of permitted tolerance
- Tyre pressure outside permitted tolerance

## Temperature compensation

Tyre pressure is a temperature-sensitive variable: pressure increases as tyre temperature rises and decreases as tyre temperature drops. Tyre temperature depends on ambient temperature as well as on the style of riding and the duration of the ride.

The tyre-pressure readings shown by the multifunction display are temperature-compensated; the reference tyre temperature for these readings is always 20 °C. The air lines available to the public in petrol stations and motorway service areas have gauges that do not compensate for temperature; the reading shown by a gauge of this nature is the temperature-dependent tyre pressure. In most instances, therefore, these gauge readings will not tally with

the pressures shown by the multifunction display.

## **Pressure adaptation**

Compare the RDC readings on the multifunction display with the value in the table on the inside cover of the Rider's Manual. Then use the air line to compensate for the difference between the RDC reading and the value in the table.

Example: According to the Rider's Manual, tyre pressure should be 2.5 bar, but the reading in the multifunction display is 2.3 bar, so pressure is low by 0.2 bar. The gauge on the air line shows 2.4 bar. You must now increase tyre pressure by the 0.2 bar difference between the value in the table and the RDC reading; when the air-line gauge shows 2.6 bar,

the tyre is inflated to the correct pressure.



## Maintenance

General instructions.....	116
Toolkit .....	116
Engine oil .....	117
Brake system .....	118
Coolant .....	122
Clutch .....	124
Rims and tyres.....	124
Wheels .....	125
Front-wheel stand .....	132
Lighting.....	133
Air filter .....	138
Jump-starting.....	140
Battery.....	141
Fuses .....	145

## General instructions

The "Maintenance" chapter describes straightforward procedures for checking and replacing certain wear parts.

Special tightening torques are listed as applicable. The tightening torques for the threaded fasteners on your vehicle are listed in the section entitled "Technical data".

Further information on maintenance and repair work is available from your BMW Motorrad authorised dealer in the form of a DVD.

Some of the work requires special tools and a thorough knowledge of the technology involved. If you are in doubt, consult a specialist workshop, preferably your authorised BMW Motorrad dealer.

## Toolkit

### Standard toolkit

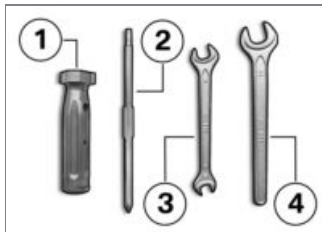

- 1** Screwdriver handle
  - Use with screwdriver insert.
  - Top up the engine oil (►► 118).
- 2** Reversible screwdriver blade
  - Phillips PH1 and Torx T25
  - Removing bulbs for front and rear turn indicators (►► 136).
  - Removing battery cover (►► 143).

- 3** Open-ended spanner
  - Width across flats 8/10
  - Removing battery cover (►► 143).
- 4** Open-ended spanner
  - Width across flats 14
  - Adjusting mirror arm (►► 80).

### Service toolkit

– with service toolkit<sup>OA</sup>



BMW Motorrad has assembled a service toolkit that is ideal for carrying out extended service work (e.g. removing and installing wheels) on this motorcycle. You

can obtain the tools set from your authorised BMW Motorrad dealer.

## Engine oil

### Check engine oil level

#### ATTENTION

**The oil level varies with the temperature of the oil. The higher the temperature, the higher the level of oil in the sump.**

Misinterpretation of the oil level

- Check the oil level only after a lengthy ride or when the engine is at operating temperature. ◀
- Switch off the engine when it is at operating temperature.
- Make sure the ground is level and firm and place the motorcycle on its centre stand.

- Wait five minutes for the oil to drain into the oil pan.

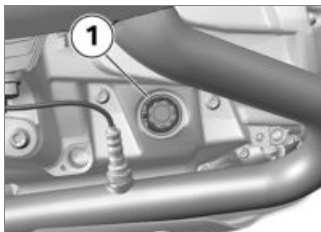

- Check the oil level in oil-level indicator **1**.



 Engine oil, specified level

between MIN and MAX marks

If the oil level is below the MIN mark:

- Top up the engine oil (➔ 118).

If the oil level is above the MAX mark:

- Have the oil level corrected by a specialist workshop, preferably an authorised BMW Motorrad dealer.

## Top up the engine oil

- Make sure the ground is level and firm and place the motorcycle on its stand.

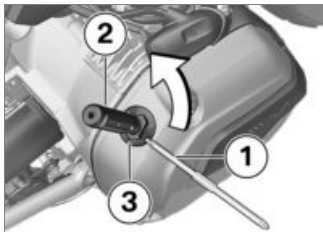

- Wipe the area around the oil filler neck clean.
- Insert Torx end of reversible screwdriver insert **1** into screwdriver handle **2** (on-board toolkit) for additional leverage.
- Engage this tool in cap **3** of the oil filler neck and turn counter-clockwise to remove.
- Check engine oil level (➡ 117).



### ATTENTION

#### Not enough or too much engine oil.

Engine damage

- Always make sure that the oil level is correct. ◀
- Top up the engine oil to the specified level.



Engine oil, quantity for topping up

max 0.95 l (Difference between MIN and MAX)

- Check engine oil level (➡ 117).
- Install cap **3** of the oil filler neck.

## Brake system

### Check operation of brakes

- Pull the front brake lever.
  - » The pressure point must be clearly perceptible.
- Press the footbrake lever.

- » The pressure point must be clearly perceptible.
- If pressure points are not clearly perceptible:



### ATTENTION

#### Work on brake system not in compliance with correct procedure.

Risk to operational reliability of the brake system.

- Have all work on the brake system undertaken by trained and qualified specialists. ◀
- Have the brakes checked by a specialist workshop, preferably an authorised BMW Motorrad dealer.

### Checking front brake pad thickness

- Make sure the ground is level and firm and place the motorcycle on its stand.





- Visually inspect the left and right brake pads to ascertain their thickness. Viewing direction: between wheel and front suspension toward brake pads **1**.



 Brake-pad wear limit, front

1.0 mm (Friction pad only, without backing plate. The wear indicators (grooves) must be clearly visible.)

If the wear indicating marks are no longer clearly visible:

 **WARNING**

**Brake-pad thickness less than permissible minimum.**

Diminished braking effect. Damage to the brakes.

- In order to ensure the dependability of the brake system, do not permit the brake pads to wear past the minimum permissible thickness. ◀
- Have the brake pads replaced by a specialist workshop, preferably an authorised BMW Motorrad dealer.

### **Check the rear brake pad thickness**

- Make sure the ground is level and firm and place the motorcycle on its stand.



- Visually inspect the brake pads to ascertain their thickness. Viewing direction: between spray guard and rear wheel toward brake pads **1**.



Brake-pad wear limit,  
rear

1.0 mm (Friction pad only,  
without backing plate.)

If the wear limit has been reached:



### WARNING

#### **Brake-pad thickness less than permissible minimum.**

Diminished braking effect. Damage to the brakes.

- In order to ensure the dependability of the brake system, do not permit the brake pads to

wear past the minimum permissible thickness. ◀

- Have the brake pads replaced by a specialist workshop, preferably an authorised BMW Motorrad dealer.

### **Check brake-fluid level, front brakes**



### WARNING

#### **Not enough brake fluid in brake fluid reservoir.**

Considerably reduced braking power due to air in the brake system.

- Check the brake-fluid level at regular intervals. ◀
- Make sure the ground is level and firm and place the motorcycle on its centre stand.
- Move the handlebars to the straight-ahead position.



- Check the brake fluid level in front reservoir **1**.

#### NOTICE

Wear of the brake pads causes the brake fluid level in the reservoir to sink. ◀

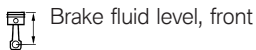

Brake fluid, DOT4

It is impermissible for the brake fluid level to drop below the MIN mark. (Brake-fluid reservoir horizontal, motorcycle upright)

If the brake fluid level drops below the permitted level:

- Have the defect rectified as quickly as possible by a specialist workshop, preferably an authorised BMW Motorrad dealer.

## Check the brake-fluid level, rear brakes

### WARNING

#### Not enough brake fluid in brake fluid reservoir.

Considerably reduced braking power due to air in the brake system.

- Check the brake-fluid level at regular intervals. ◀
- Make sure the ground is level and firm and place the motorcycle on its centre stand.



- Check the brake fluid level in rear reservoir **1**.

**NOTICE**

Wear of the brake pads causes the brake fluid level in the reservoir to sink. ◀



Brake fluid level, rear

Brake fluid, DOT4

It is impermissible for the brake fluid level to drop below the MIN mark. (Brake-fluid reservoir horizontal, motorcycle upright)

If the brake fluid level drops below the permitted level:

- Have the defect rectified as quickly as possible by a specialist workshop, preferably an authorised BMW Motorrad dealer.

**Coolant****Check coolant level**

- Make sure the ground is level and firm and place the motorcycle on its stand.

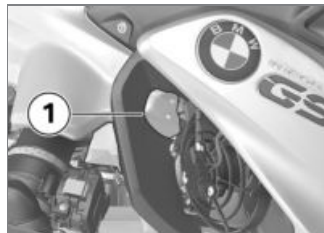
**CAUTION****Hot engine.**

Risk of burn injury

- Keep clear of all hot engine components.
- Do not touch hot engine components. ◀

- Check the coolant level in expansion tank **1**.

If the coolant drops below the permitted level:

- Top up the coolant.

## Topping up coolant

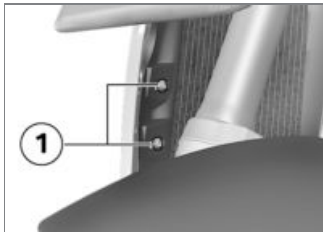

- Remove screws **1**.



- Remove body-bound rivet **1**.
- Remove screws **2**.
- Pull the side panel at positions **3** and **4** to disengage it from the holders.



- Open cap **1** of the coolant expansion tank and top up the coolant to the specified level.
- Check coolant level (→ 122).
- Close the cap of the coolant expansion tank.



- Seat the side panel in mounts **1**.



- Install screws **1**.
- Install body-bound rivet **2**.

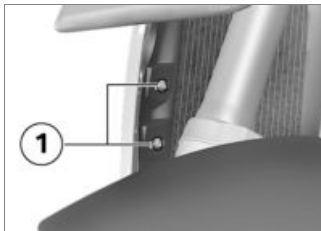

- Install screws **1**.

## Clutch

### Checking clutch function

- Pull the clutch lever.
  - » The pressure point must be clearly perceptible.

If the pressure point is not clearly perceptible:

- Have the clutch checked by a specialist workshop, preferably an authorised BMW Motorrad dealer.

## Rims and tyres

### Checking rims

- Make sure the ground is level and firm and place the motor-cycle on its stand.
- Visually inspect the rims for defects.
- Have any damaged rims inspected by a specialist workshop and replaced if necessary, preferably by an authorised BMW Motorrad dealer.

### Checking tyre tread depth



#### WARNING

### Riding with badly worn tyres

Risk of accident due to impaired handling

- If applicable, have the tyres changed in good time before they wear to the minimum tread depth permitted by law. ◀

- Make sure the ground is level and firm and place the motorcycle on its stand.
- Measure the tyre tread depth in the main tread grooves with wear marks.



## NOTICE

Wear indicators are built into the main profile grooves on each tyre. The tyre is worn out when the tyre tread has worn down to the level of the marks. The locations of the marks are indicated on the edge of the tyre, e.g. by the letters TI, TWI or by an arrow. ◀

If the tyre tread is worn to minimum:

- Replace tyre or tyres, as applicable.

## Check spokes

– with cross-spoked wheels<sup>OE</sup>

- Make sure the ground is level and firm and place the motorcycle on its stand.
- Draw the handle of a screwdriver or a similar instrument across the spokes and listen to the notes of the individual spokes.

If the notes vary:

- Have the spokes checked by a specialist workshop, preferably an authorised BMW Motorrad dealer.

## Wheels

### Tyre recommendation

For each size of tyre, BMW Motorrad tests and classifies as roadworthy certain makes. BMW Motorrad cannot assess the suitability or provide

any guarantee of road safety for other tyres.

BMW Motorrad recommends using only tyres tested by BMW Motorrad.

It is absolutely essential to observe the maximum permissible speed and load-capacity ratings (see "Technical data").

Comply with the instructions regarding maximum speed for riding with knobby tyres or winter tyres fitted (▶▶▶ 87).

You can obtain detailed information from your authorised BMW Motorrad dealer or on the Internet at **[www.bmw-motorrad.com](http://www.bmw-motorrad.com)**.

### Effect of wheel size on chassis and suspension control systems

Wheel size is very important as a parameter for the chassis and suspension control systems ABS and ASC. In particu-

lar, the diameter and the width of a vehicle's wheels are programmed into the control unit and are fundamental to all calculations. Any change in these influencing variables, caused for example by a switch to wheels other than those installed ex-works, can have serious effects on the performance of the control systems.

The sensor rings are essential for correct road-speed calculation, and they too must match the motorcycle's control systems and consequently cannot be changed.

If you decide that you would like to fit non-standard wheels to your motorcycle, it is very important to consult a specialist workshop beforehand, preferably an authorised BMW Motorrad dealer. In some cases, the data programmed into the control

units can be changed to suit the new wheel sizes.

### RDC label

- with tyre pressure monitoring (RDC)<sup>OE</sup>

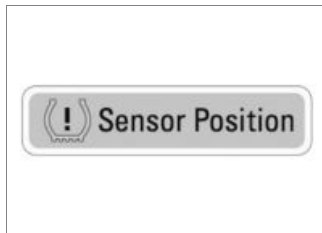

### ATTENTION

#### **Tyre removal not in compliance with correct procedure.**

Damage to RDC sensors.

- Be sure to explain to the specialist workshop or authorised BMW Motorrad dealer that the wheel is fitted with an RDC sensor. ◀

If the motorcycle is equipped with RDC, each wheel rim bears an adhesive label indicating the position of the RDC sensor. When changing the tyre, take care not to damage the RDC sensor. Be sure to draw the attention of the authorised BMW Motorrad dealer or specialist workshop to the fact that the wheel is fitted with an RDC sensor.

### Removing front wheel

- Make sure the ground is level and firm and place the motorcycle on its centre stand.



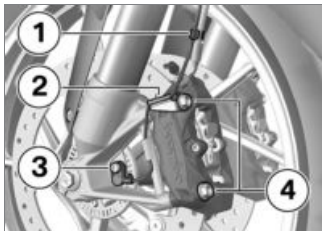

- Disengage the cable for the wheel-speed sensor from retaining clips **1** and **2**.
- Remove screw **3** and remove the wheel-speed sensor from its bore.
- Mask off the parts of the wheel rim that could be scratched in the process of removing the brake calipers.



### ATTENTION

#### Brake pads pushed together with brake caliper removed.

It is not possible to slip the brake caliper over the brake disc.

- Do not operate the handbrake lever while a brake caliper has been removed.◀
- Remove securing screws **4** of the left and right brake calipers.

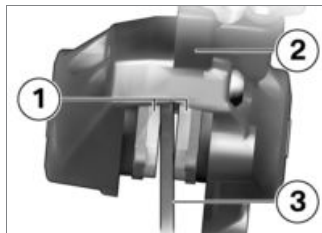

- Force the brake pads **1** slightly apart by rotational movement of the brake caliper **2** against brake disc **3**.
- Carefully pull the brake calipers back and out until clear of the brake discs.

- Lift the front of the motorcycle until the front wheel is clear of the ground, preferably using a BMW Motorrad front-wheel stand.
- Install the front-wheel stand (▶▶ 132).



- Remove right-hand axle clamping screw **1**.

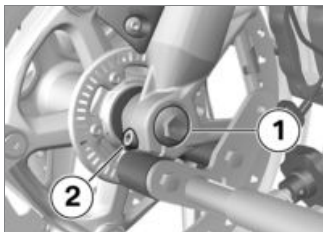

- Remove screw **1**.
- Remove left-hand axle clamping screw **2**.
- Press quick-release axle slightly toward the inside, so as to be better able to grip it on the right-hand side.



- Withdraw quick-release axle **1**, support the front wheel when doing this.
- Set down front wheel and roll forwards out of the front suspension.

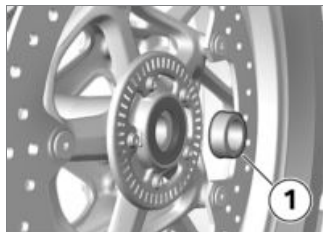

- Remove spacer bush **1** from the wheel hub.

### Installing front wheel



#### WARNING

#### Use of a non-standard wheel.

Malfunctions in operation of ABS and ASC.

- See the information on the effect of wheel size on the ABS and ASC systems at the start of this chapter. ◀

## ATTENTION

### Tightening threaded fasteners to incorrect tightening torque.

Damage, or threaded fasteners work loose.

- Always have the security of the fasteners checked by a specialist workshop, preferably an authorised BMW Motorrad dealer. ◀



- Slip spacing bushing **1** into the wheel hub on the left-hand side.

## ATTENTION

### Front wheel installed wrong way round.

Risk of accident

- Note direction-of-rotation arrows on tyre or rim. ◀
- Roll the front wheel into position between the front forks.

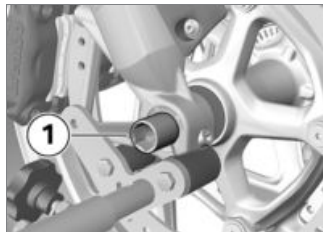

- Lift front wheel and fit quick-release axle **1**.
- Remove front-wheel stand and firmly compress front forks several times. Do not operate front brake lever.

- Install the front-wheel stand (▶▶ 132).

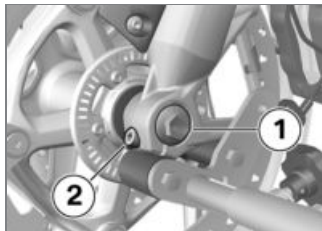

- Install screw **1** and tighten to specified torque. Counter-hold quick-release axle on the right-hand side.

 Quick-release axle in telescopic forks

30 Nm

- Tighten left-hand axle clamping screw **2** to the specified torque.

 Clamping screw for quick-release axle in telescopic fork

19 Nm



- Tighten right axle clamping screw **1** to the specified torque.

 Clamping screw for quick-release axle in telescopic fork

19 Nm

- Remove the front-wheel stand.

- Position left and right brake calipers on the brake discs.

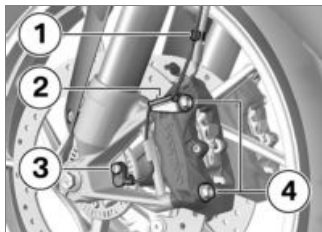

- Install securing screws **4** on left and right and tighten to specified tightening torque.

 Brake caliper on telescopic fork

38 Nm

- Remove the adhesive tape from the wheel rim.

 **WARNING**

**Brake pads not contacting the brake disc.**

Delayed braking effect.

- Before riding off, always check that the brakes bite as soon as the brake lever is pulled or the brake pedal depressed. ◀
- Operate the brake several times until the brake pads are bedded.
- Seat the cable for the wheel-speed sensor in retaining clips **1** and **2**.
- Insert the wheel-speed sensor into the bore and install screw **3**.

 Wheel-speed sensor to fork leg

Joining compound: Micro-encapsulated or medium-strength thread-locking compound

8 Nm

## Removing rear wheel

- Make sure the ground is level and firm and place the motorcycle on its centre stand.
- Engage first gear.

### CAUTION

#### Hot exhaust system.

Risk of burn injury

- Do not touch a hot exhaust system. ◀
- Allow rear silencer to cool down.



- Remove studs **1** from the rear wheel, while supporting the wheel.
- Roll the rear wheel out toward the rear.

## Install the rear wheel

### WARNING

#### Use of a non-standard wheel.

Malfunctions in operation of ABS and ASC.

- See the information on the effect of wheel size on the ABS and ASC systems at the start of this chapter. ◀

### ATTENTION

#### Tightening threaded fasteners to incorrect tightening torque.

Damage, or threaded fasteners work loose.

- Always have the security of the fasteners checked by a specialist workshop, preferably an authorised BMW Motorrad dealer. ◀
- Seat the rear wheel on the rear-wheel adapter.



- Install wheel studs **1** and tighten to specified torque.



Rear wheel to wheel flange

Tightening sequence: tighten in diagonally opposite sequence

60 Nm

## Front-wheel stand

### Install the front-wheel stand



#### ATTENTION

**Use of the BMW Motorrad front wheel stand without also accompanying use of centre stand or auxiliary stand.**

Risk of damage to parts if vehicle topples.

- Place the motorcycle on its centre stand or another auxiliary stand before lifting the front wheel with the BMW Motorrad front-wheel stand. ◀
- Make sure the ground is level and firm and place the motorcycle on its centre stand.
- Use basic stand with front-wheel adapter. The basic stand and its accessory

parts are available from your BMW Motorrad dealer.

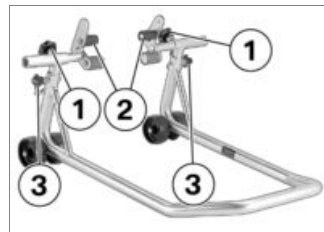

- Remove screws **1**.
- Push the two adapters **2** apart until the front forks fit between them.
- Use locating pins **3** to set the front-wheel stand to the desired height.
- Centre the front-wheel stand relative to the front wheel and push it against the front axle.

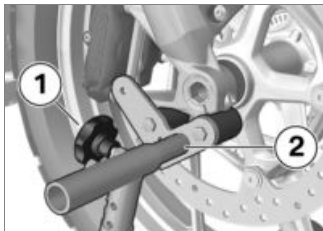

- Align the two adapters **2** so that the front forks are securely seated.
- Tighten screws **1**.

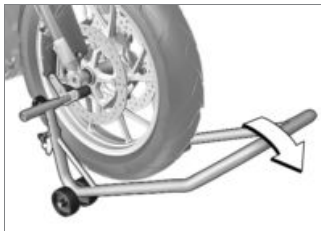

#### **ATTENTION**

#### **Centre stand retracts if motorcycle lifted too high.**

Risk of damage to parts if vehicle topples.

- When raising the vehicle, make sure that the centre stand remains on the ground.◀
- Apply uniform pressure to push the front-wheel stand down and raise the motorcycle.

## Lighting

### Replacing bulbs for low-beam and high-beam headlight

– without LED headlights<sup>OE</sup>

#### **NOTICE**

The positions of the plug, the spring wire retainer and the bulb might not be as illustrated below.◀

- Make sure the ground is level and firm and place the motorcycle on its stand.
- Switch off the ignition.



- Remove cover **1** by turning it counter-clockwise to replace the bulb for the low-beam headlight.



- Remove cover **1** by turning it counter-clockwise to replace

the bulb for the high-beam headlight.



- Disconnect plug **1**.



- Disengage spring clip **1** and swing it aside.
- Remove bulb **2**.

- Replace the defective bulb.



Bulbs for the low-beam headlight

H7 / 12 V / 55 W

– with LED headlights<sup>OE</sup>

LED<



Bulb for high-beam headlight

H7 / 12 V / 55 W

– with LED headlights<sup>OE</sup>

LED<

- Hold the bulb by the base only, in order to keep the glass free of foreign matter.



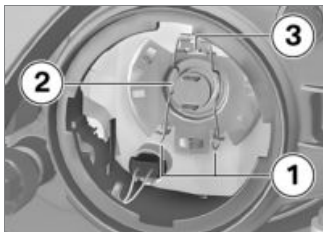

- Insert bulb **2**, making sure that tab **3** is correctly positioned.

#### NOTICE

The bulb might face in a direction other than that shown here. ◀

- Engage spring clip **1** in the catch.



- Connect plug **1**.
- Place cover in position and fit by turning clockwise.

### Replacing bulb for parking light

– without LED headlights<sup>OE</sup>

- Make sure the ground is level and firm and place the motorcycle on its stand.
- Switch off the ignition.



- Remove cover **1** by turning it counter-clockwise.



- Pull socket **1** out of the headlight housing.



- Remove bulb **1** from the socket.
- Replace the defective bulb.

 Bulb for parking light

W5W / 12 V / 5 W

– with LED headlights<sup>OE</sup>

LED<

- Use a clean, dry cloth to hold the bulb in order to keep the glass free of foreign matter.



- Insert bulb **1** into the socket.

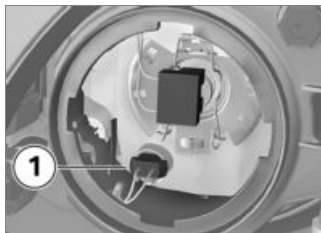

- Install socket **1** in the headlight housing.
- Place cover in position and fit by turning clockwise.

## Replacing bulbs for front and rear turn indicators

– without LED turn indicators<sup>OE</sup>

- Make sure the ground is level and firm and place the motorcycle on its stand.
- Switch off the ignition.



- Remove screw **1**.



- Pull the glass out of the light housing at the threaded-fastener side.

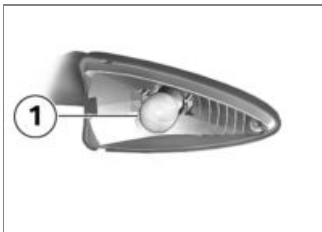

- Turn bulb **1** counter-clockwise and remove it from the light housing.<

- Replace the defective bulb.



Bulbs for flashing turn indicators, front

RY10W / 12 V / 10 W

– with LED turn indicators<sup>OE</sup>

LED<



Bulbs for flashing turn indicators, rear

RY10W / 12 V / 10 W

– with LED turn indicators<sup>OE</sup>

LED<

- Use a clean, dry cloth to hold the bulb in order to keep the glass free of foreign matter.

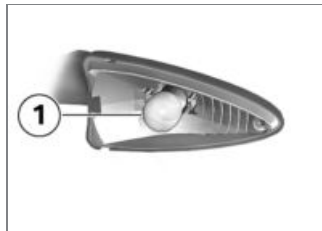

- Turn bulb **1** clockwise to install it in the light housing.



- Working from the inboard side, insert the glass into the light housing and close the housing.



- Install screw **1**.

### Replacing LED rear light

The LED rear light can be replaced only as a complete unit.

- Consult a specialist workshop, preferably an authorised BMW Motorrad dealer.

### Replacing LED turn indicators

– with LED turn indicators<sup>OE</sup>

- The LED turn indicators can be replaced only as a complete unit. Consult a specialist workshop, preferably an authorised BMW Motorrad dealer.<

### Replacing LED headlight

– with LED headlights<sup>OE</sup>

- LED headlights can be replaced only as a complete unit. Consult a specialist workshop, preferably an authorised BMW Motorrad dealer.<

### Replacing LED auxiliary headlights

– with LED auxiliary headlights<sup>OA</sup>

The LED auxiliary headlights can only be replaced as a unit; it is not possible to replace individual LEDs.

Consult a specialist workshop, preferably an authorised BMW Motorrad dealer.

### Air filter

#### Replacing air-filter element



- Remove front seat (➡ 81).
- Remove screws **1** and screws **2**.
- Remove the centre trim panel.

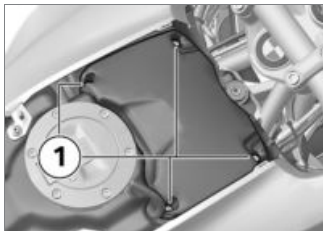

- Remove screws **1**.
- Remove the air filter cover.

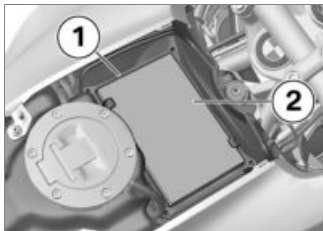

- Remove frame **1**.
- Remove air filter element **2**.

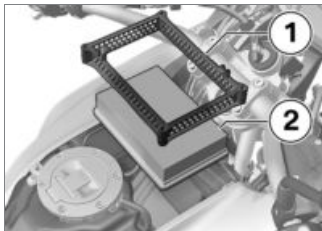

- Clean or, as necessary, replace air filter element **2**.
- Insert air filter element **2** and frame **1**.

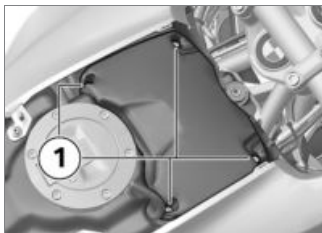

- Install the air filter cover.
- Install screws **1**.

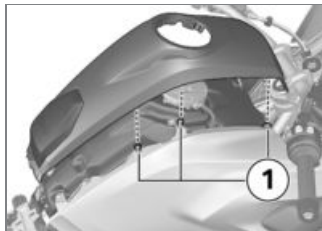

- Place centre trim panel in position, paying attention to the connections **1** to the side panels.



- Fit screws **1** and screws **2**.
- Installing front seat (➔ 83).

## Jump-starting



### ATTENTION

#### Excessive current flowing when the motorcycle is jump-started

Wiring smoulders/ignites or damage to the on-board electronics

- If the motorcycle has to be jump-started connect the leads to the battery terminals; never attempt to jump-start the engine by connecting leads to the on-board socket.◀



### ATTENTION

#### Contact between crocodile clips of jump leads and vehicle.

Risk of short-circuit

- Use jump leads fitted with fully insulated crocodile clips at both ends.◀



### ATTENTION

#### Jump-starting with a voltage greater than 12 V.

Damage to the on-board electronics.

- Make sure that the battery of the donor vehicle has a voltage rating of 12 V.◀
- Make sure the ground is level and firm and place the motorcycle on its stand.
- Removing battery cover (▶▶▶ 143).
- When jump-starting the engine, do not disconnect the battery from the on-board electrical system.

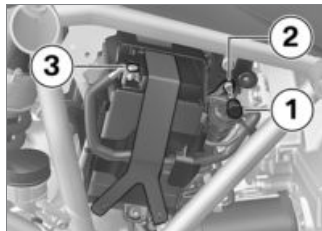

- Remove protective cap **1**.
- Use the red jumper cable to connect the positive terminal **2** of the discharged battery to the positive terminal of the donor battery.



### NOTICE

If the 12 V battery is not correctly installed or if the polarity of the terminals is reversed (e.g. in an attempt to jump-start the vehicle), this can cause the fuse for the alternator regulator to blow.◀

- Then connect one end of the black jump lead to the negative terminal of the donor battery and the other end to negative terminal **3** of the discharged battery.
- Run the engine of the donor vehicle during jump-starting.
- Start the engine of the vehicle with the discharged battery in the usual way; if the engine does not start, wait a few minutes before repeating the attempt in order to protect the starter motor and the donor battery.
- Allow both engines to idle for a few minutes before disconnecting the jump leads.
- Disconnect the jump lead from the negative terminals first, then disconnect the second lead from the positive terminals.

## NOTICE

Do not use proprietary start-assist sprays or other products to start the engine. ◀

- Install the protective cap.
- Fitting battery cover (▶▶ 145).

## Battery

### Maintenance instructions

Correct upkeep, recharging and storage will prolong the life of the battery and are essential if warranty claims are to be considered.

Compliance with the points below is important in order to maximise battery life:

- Keep the surface of the battery clean and dry.
- Do not open the battery.
- Do not top up with water.
- Be sure to read and comply with the instructions for char-

ging the battery on the following pages.

- Do not turn the battery upside down.

## ATTENTION

### On-board electronics (e.g. clock) draining connected battery.

Battery is deep-discharged; this voids the guarantee.

- Connect a float charger to the battery if the motorcycle is to remain out of use for more than four weeks. ◀

## NOTICE

BMW Motorrad has developed a float charger specially designed for compatibility with the electronics of your motorcycle. Using this charger, you can keep the battery charged during long periods of disuse, without having

to disconnect the battery from the motorcycle's on-board systems. You can obtain additional information from your authorised BMW Motorrad dealer.◀

## Charge battery when connected

### ATTENTION

#### Charging connected battery via the battery terminals.

Damage to the on-board electronics.

- Disconnect the battery at the battery terminals before charging.◀

### ATTENTION

#### Charging a fully discharged battery via the on-board socket or the extra socket.

Damage to the on-board electronics.

- If a battery has discharged to the extent that it is completely flat (battery voltage less than 9 V, status-indicator lights and multifunction display remain off when the ignition is switched on) **it has to be disconnected from the on-board circuits** and re-charged with the charger connected directly to the battery posts.◀

### ATTENTION

#### Unsuitable battery chargers connected to an on-board socket.

Damage to charger and to frame and suspension electronics.

- Use suitable BMW chargers. The suitable charger is available from your authorised BMW Motorrad dealer.◀
- Charge via the charging socket, with the battery connected

to the motorcycle's on-board electrical system.

### NOTICE

The motorcycle's on-board electronics know when the battery is fully charged. The on-board socket is switched off when this happens.◀

- Comply with the operating instructions of the charger.

### NOTICE

If you are unable to charge the battery through the on-board socket, you may be using a charger that is not compatible with your motorcycle's electronics. If this happens, disconnect the battery from the on-board systems and connect the charger directly to the battery.◀



## Charging battery when disconnected

- Charge the battery using a suitable charger.
- Comply with the operating instructions of the charger.
- Once the battery is fully charged, disconnect the charger's terminal clips from the battery terminals.

### NOTICE

The battery has to be recharged at regular intervals in the course of a lengthy period of disuse. See the instructions for caring for your battery. Always fully recharge the battery before restoring it to use.◀

## Removing battery

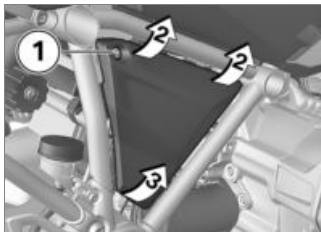

- Switch off the ignition.
  - Remove screw **1**.
  - Each battery cover slightly forward at the top at positions **2**.
  - In order not to damage the battery cover or the mount, work the battery cover up at position **3** to remove.
- with alarm system (DWA)<sup>OE</sup>
- If applicable, switch off the anti-theft alarm.◀

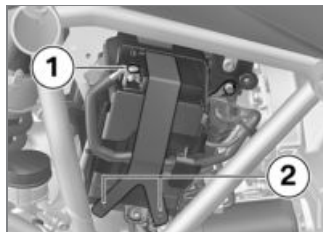

- Disconnect battery negative lead **1** and disengage rubber strap **2**.



- Pull retaining plate in position **1** outwards and remove in an upward direction.

- Slightly lift battery and remove from the mounting to such an extent that the battery positive terminal becomes accessible.



- Disconnect battery negative lead **1** and remove the battery.

## Installing battery

### NOTICE

If the 12 V battery is not correctly installed or if the polarity of the terminals is reversed (e.g. in an attempt to jump-start the vehicle), this can cause the

fuse for the alternator regulator to blow. ◀

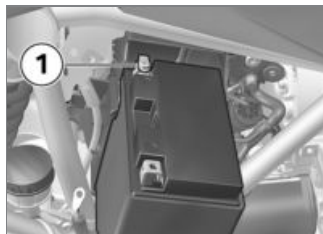

- Secure battery positive lead **1**.
- Push battery into the mounting.



- First insert retaining plate into the mountings **1** and then push under the battery in position **2**.

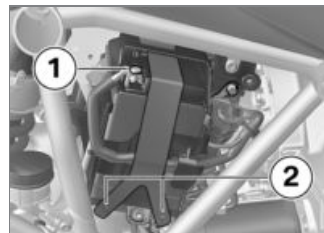

- Secure battery negative lead **1**.
- Secure the battery with rubber strap **2**.



- Place battery cover into the mounting **1** and press into the mountings **2**.



- Install screw **1**.
- Setting the clock (➡ 54).
- Setting the date (➡ 54).

## Fuses

### Replacing fuses

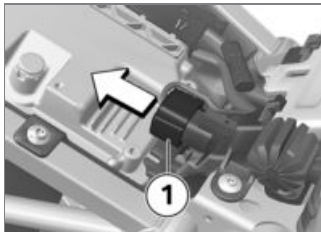

- Switch off the ignition.
- Remove front seat (➡ 81).
- Disconnect plug **1**.

### ATTENTION

#### Jumping of blown fuses.

Risk of short-circuit and fire.

- Always replace a defective fuse with a new fuse of the same amperage. ◀
- Replace faulty fuse in accordance with the fuse allocation diagram.

### NOTICE

If fuse defects recur frequently have the electric circuits checked by a specialist workshop, preferably an authorised BMW Motorrad dealer. ◀

- Install plug **1**.
- Installing front seat (➡ 83).

### Fuse assignment

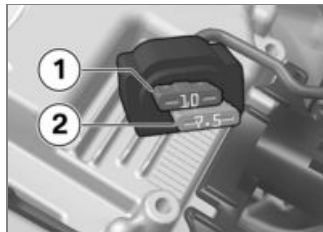

- 1** 10 A  
Instrument panel  
Anti-theft alarm (DWA)  
Ignition switch  
Diagnostic socket

- 2** 7.5 A  
Multifunction switch, left  
Tyre pressure monitoring  
(RDC)

### Fuse for the alternator regulator

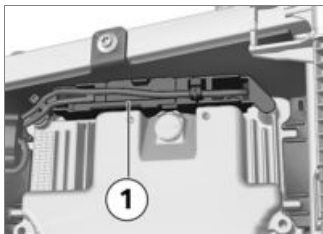

- 1** 50 A  
Alternator regulator

## **Accessories**

General instructions.....	148
Power sockets .....	148
Navigation system .....	149
Cases.....	154
Topcase .....	157

## General instructions

### CAUTION

#### Use of other-make products.

Safety risk

- BMW Motorrad cannot examine or test each product of outside origin to ensure that it can be used on or in connection with BMW vehicles without constituting a safety hazard. Country-specific official authorisation does not suffice as assurance. Tests conducted by these instances cannot make provision for all operating conditions experienced by BMW vehicles and, consequently, they are not sufficient in some circumstances.
- Use only parts and accessories approved by BMW for your vehicle. ◀

BMW has conducted extensive testing of the parts and ac-

cessory products to establish that they are safe, functional and suitable. Consequently, BMW accepts product liability. BMW accepts no liability whatsoever for parts and accessories that it has not approved.

Whenever you are planning modifications, comply with all the legal requirements. Make sure that the vehicle does not infringe the national road-vehicle construction and use regulations applicable in your country. Your BMW Motorrad dealer can offer expert advice on the choice of genuine BMW parts, accessories and other products. You can examine all the optional accessories from BMW Motorrad by visiting our website:

**"[www.bmw-motorrad.com](http://www.bmw-motorrad.com)".**

## Power sockets

### Connection of electrical devices

- You can start using electrical devices connected to the motorcycle's sockets only when the ignition is switched on.

### Cable routing

- The cables from the power sockets to the auxiliary devices must be routed in such a way that they do not impede the rider.
- The cable routing should not restrict the steering angle or obstruct handling.
- The cables must not be trapped.

### Automatic shutdown

- The sockets will be automatically switched off during the start procedure.

- The power supply to the sockets is switched off no more than 15 minutes after the ignition is switched off, in order to prevent overloading of the on-board electrics. Low-wattage electrical accessories might not be recognised by the vehicle's electronics. In such cases, power sockets are switched off very shortly after the ignition is turned off.
- If the battery charge state is too low to maintain the motorcycle's start capability, the power sockets are switched off.
- The power sockets are also switched off when the maximum load capability as stated in the technical data is exceeded.

## Navigation system

- with preparation for navigation system<sup>OE</sup>

### Securing navigation device

#### NOTICE

The navigation preparation option is compatible with the BMW Motorrad Navigator IV and the BMW Motorrad Navigator V.◀

#### NOTICE

The latching system of the Mount Cradle is not designed to protect against theft. Always remove the navigation system and stow it away safely as soon as you finish your ride.◀

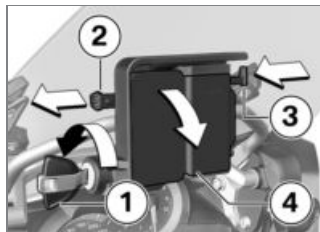

- Turn ignition key **1** counter-clockwise.
- Pull retainer **2** to the **left**.
- Press in lock **3**.
- » The Mount Cradle is released and cover **4** can be pivoted forward and removed.

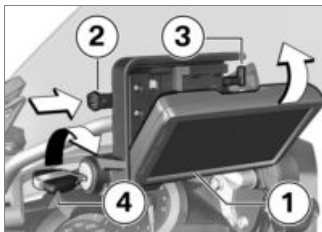

- Insert navigation device **1** at bottom and pivot it toward the rear.
- » The navigation device engages with an audible click.
- Push retainer **2** fully to the **right**.
- » Lock **3** is engaged.
- Turn ignition key **4** clockwise.
- » The navigation device is secured and the ignition key can be removed.

## Removing navigation device and installing cover

### ATTENTION

#### Dust and dirt on contacts of the Mount Cradle.

Damage to the contacts.

- Always reinstall the cover as soon as you finish your ride. ◀

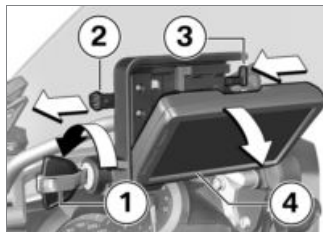

- Turn vehicle key **1** counter-clockwise.
- Pull retainer **2** fully to the **left**.
- » Lock **3** is disengaged.
- Push lock **3** fully to the **left**.

- » Navigation device **4** is unlocked.
- Tilt navigation device **4** and work it downward to remove.

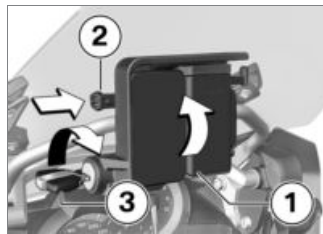

- Insert cover **1** at bottom and pivot it up.
- » The cover engages with an audible click.
- Push retainer **2** to the **right**.
- Turn vehicle key **3** clockwise.
- » Cover **1** is secured.



## Operating navigation system

### NOTICE

The description below is based on the Navigator V. The Navigator IV does not support all the possibilities described here.◀

### NOTICE

Only the latest version of the BMW Motorrad communication system is supported. A software update of the BMW Motorrad communication system may be necessary. If this is the case, consult your authorised BMW Motorrad dealer.◀

If the BMW Motorrad Navigator is fitted, some of its functions can be controlled directly from the handlebars using the Multi-Controller.



The Multi-Controller is operated by means of six movements:

- Turning upwards and downwards.
- Short operation to the left and right.
- Extended operation to the left and right.

Turning the Multi-Controller with the Compass or Mediaplayer page open increases or decreases the volume of a BMW Motorrad communication system connected via Bluetooth.

In the BMW special menu, the menu items are selected by turning the Multi-Controller.

Short operation of the Multi-Controller to the left or right changes between the main pages of the Navigator:

- Map view
- Compass
- Mediaplayer
- BMW special menu
- My Motorcycle page

Long-pushing the Multi-Controller corresponds to activating certain functions on the Navigator display. An arrow to the right or to the left above the corresponding button area on the display indicates a function that can be activated in this way.

 Long-push to the right to activate this function.



Long-push to the left to activate this function.

In detail, the following functions can be controlled:

### Map view

- Turn up: Zoom in.
- Turn down: Zoom out.

### Compass page

- Turning increases or decreases the volume of a BMW Motorrad communication system connected via Bluetooth.

### BMW special menu

- Speak: Repeat most recent navigation announcement.
- Waypoint: Save current location as a favourite.
- Home: Starts navigation to home address (greyed if no home address has been defined).

- Mute: Switch automatic navigation announcements off or on (off: a crossed-out lips symbol appears in the top line of the display). "Speak" will still activate navigation announcements. All other acoustic outputs remain switched on.
- Switch off display: Deactivate the display.
- Dial home number: Dials the home phone number saved in the Navigator (not shown unless a telephone is connected).
- Diversion: Activates the diversion function (not shown unless a route is active).
- Skip: Skips the next waypoint (not shown unless the route has waypoints).

### My Motorcycle

- Turn: Changes the number of data shown.

- Touch a data field on the display to open the menu for selecting data.
- The values available for selection depend on the optional extras installed on the vehicle.



### NOTICE

The Mediaplayer function is available only with a Bluetooth device supporting the A2DP standard, for example a BMW Motorrad communication system. ◀

### Mediaplayer

- Long-push to the left: Play preceding track.
- Long-push to the right: Play next track.
- Turning increases or decreases the volume of a BMW Motorrad communication system connected via Bluetooth.

## Warnings and status messages



Warning and status messages from the motorcycle are indicated by a symbol **1** appearing at the top left in the map view.

### NOTICE

If a BMW Motorrad communication system is connected, warnings are accompanied by an acoustic signal. ◀

If there are two or more active warnings the number appears below the warning triangle.

Touching the warning triangle when more than one warning is active opens a list of all the warnings. Additional information appears as soon as a message is selected.

### NOTICE

Detailed information cannot be displayed for all warnings. ◀

## Special functions

Integration of the BMW Motorrad Navigator has produced a number of deviations from the descriptions in the operating instructions for the Navigator.

### Reserve fuel level warning

The settings for the fuel gauge are not available, because the reserve fuel level warning is sent by the vehicle to the Navigator. Touch the message when it is active to view the locations of the nearest filling stations.

## Time and date

The Navigator sends the time and date to the motorcycle. The transfer of these data into the instrument cluster must be activated in the **SETUP** menu of the instrument cluster.

## Security settings

The BMW Motorrad Navigator V can be secured against unauthorised use with a four-digit PIN (Garmin Lock). If this function is activated, while the Navigator is cradled on the motorcycle and the ignition is switched on you are prompted to add the motorcycle to the list of secured vehicles. If you answer "Yes" at this prompt the Navigator saves the VIN of this vehicle in its internal memory. A maximum of five VINs can be saved in this way. Subsequently, the PIN does not have to be entered when the

Navigator is switched on by ignition ON while cradled in any of these vehicles.

If the Navigator is removed from the vehicle while switched on, a security prompt asking for the PIN to be entered is issued.

### Screen brightness

Screen brightness is adjusted by the motorcycle while the unit is cradled. No manual input is necessary.

If you prefer, you can switch off automatic adjustment in the Navigator display settings.

## Cases

### Opening cases

– with cases<sup>OA</sup>

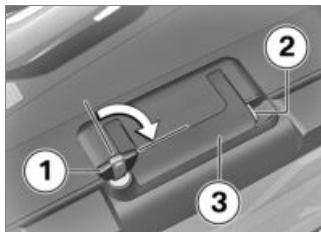

- Turn key **1** clockwise.
- Keep the yellow latch **2** held and fold out the carry handle **3**.



- Push yellow button **1** down and at the same time open the lid of the case.

### Adjusting case volume

– with cases<sup>OA</sup>

- Open the case and remove all its contents.



- Engage pivot lever **1** at the top limit position to set the case to minimum volume.
- Engage pivot lever **1** at the bottom limit position to set the case to maximum volume.
- Close the case.

## Closing cases

– with cases<sup>OA</sup>

- Turn the lock with the key until it is at right angles to the forward direction of travel.
- Close the case lid.
- » The lid engages with an audible click.

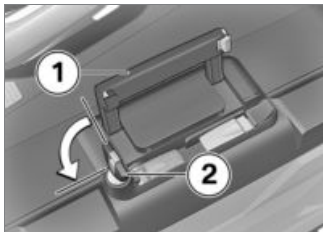

### ATTENTION

#### Closure of carrying handle with case lock latched.

Damage to locking tab.

- Make sure that the case lock is at right angles to the forward

direction of travel when you close the carry handle.◀

- Close carry handle **1**.
- Turn key **2** counter-clockwise and remove.

## Removing cases

– with cases<sup>OA</sup>

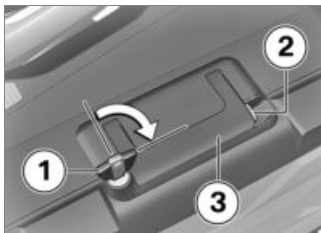

- Turn key **1** clockwise.
- Keep the yellow latch **2** held and fold out the carry handle **3**.

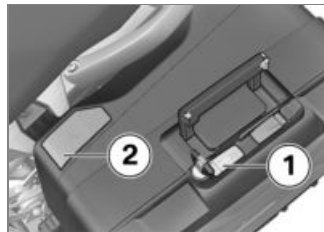

- Pull red release lever **1** up.  
» Latching flap **2** pops up.
- Fully open the latching flap.
- Take a firm grip of the handle and lift the case out of the holder.

## Mounting cases

– with cases<sup>OA</sup>



- Pull red release lever **1** up.  
» Latching flap **2** pops up.
- Fully open the latching flap.

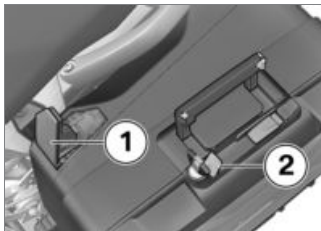

- Press latching flap **1** down until resistance is felt.
- Then simultaneously press down latching flap and red release lever **2**.  
» The latching flap engages.

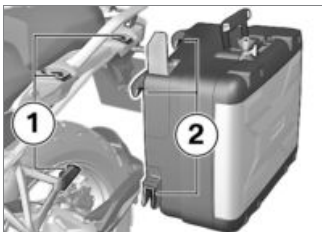

- Place box from the top into the mountings **1** and **2**.

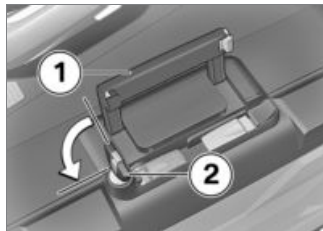

### ATTENTION

#### Closure of carrying handle with case lock latched.

Damage to locking tab.

- Make sure that the case lock is at right angles to the forward direction of travel when you close the carry handle. ◀
- Close carry handle **1**.
- Turn key **2** counter-clockwise and remove.

## Maximum payload and maximum permissible speed

Note the maximum permissible payload and the speed limit for riding with cases fitted, as stated on the label inside the case.

Contact your authorised BMW Motorrad dealer if you cannot find your combination of vehicle and cases on the label.

The values for the combination described here are as follows:



Maximum permissible speed for riding with Vario cases fitted to the motorcycle

max 180 km/h



Payload per Vario case

max 10 kg

## Topcase

### Opening topcase

– with topcase<sup>OA</sup>

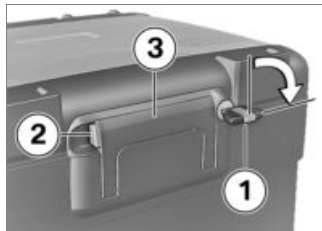

- Turn key **1** clockwise.
- Keep the yellow latch **2** held and fold out the carry handle **3**.

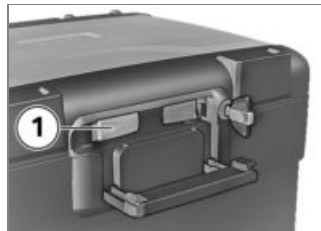

- Push yellow button **1** forward and at the same time open the lid of the topcase.

### Adjusting topcase volume

– with topcase<sup>OA</sup>

- Open the topcase and remove all its contents.



- Engage pivot lever **1** at the front limit position to set the case to maximum volume.
- Engage pivot lever **1** at the rear limit position to set the case to minimum volume.
- Close the topcase.

### Closing topcase

– with topcase<sup>OA</sup>

- Press down firmly on the topcase lid to close.

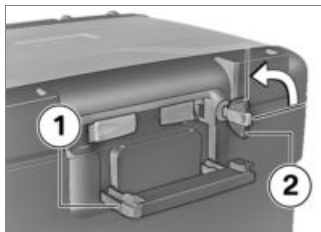

### ATTENTION

#### Closure of carrying handle with case lock latched.

Damage to locking tab.

- Make sure that the topcase lock is vertical when you close the carry handle. ◀
- Close carry handle **1**.
  - » The handle engages with an audible click.
- Turn key **2** counter-clockwise and remove.

### Removing the topcase

– with topcase<sup>OA</sup>

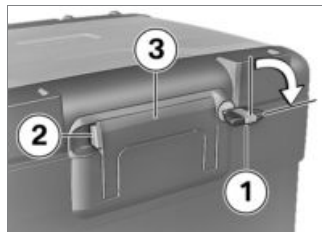

- Turn key **1** clockwise.
- Keep the yellow latch **2** held and fold out the carry handle **3**.





- Pull red lever **1** back as far as it will go.
  - » Latching flap **2** pops up.
- Fully open the latching flap.
- Take a firm grip of the handle and lift the topcase out of the holder.

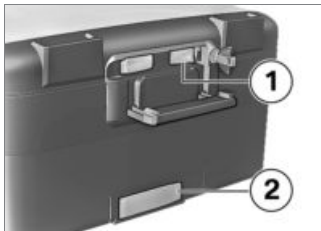

- Pull red lever **1** back as far as it will go.
  - » Latching flap **2** pops up.
- Fully open the latching flap.



- Engage the topcase in front holders **1** of the topcase carrier plate.
- Press the topcase onto the topcase carrier plate at the rear.

## Mounting topcase

– with topcase<sup>OA</sup>



- Press latching flap **1** forward until resistance is felt.
- Next simultaneously press down latching flap and red release lever **2**.
- » The latching flap engages.

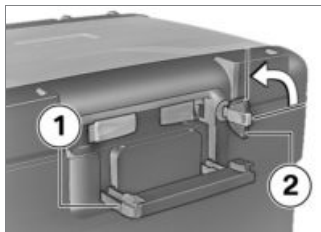

## ATTENTION

### Closure of carrying handle with case lock latched.

Damage to locking tab.

- Make sure that the topcase lock is vertical when you close the carry handle.◀
- Close carry handle **1**.
- » The handle engages with an audible click.
- Turn key **2** counter-clockwise and remove.

## Maximum payload and maximum permissible speed

Note the maximum permissible payload and the speed limit for riding with topcase fitted, as stated on the label inside the topcase.

Contact your authorised BMW Motorrad dealer if you cannot find your combination of vehicle and topcase on the label.

The values for the combination described here are as follows:



Maximum permissible speed for riding with Vario topcase fitted to the motorcycle

max 180 km/h



Payload of Vario topcase

max 5 kg

## Care

Care products .....	162
Washing the vehicle .....	162
Cleaning easily damaged components.....	163
Paint care .....	164
Laying up the motorcycle .....	164
Protective wax coating .....	164
Restoring motorcycle to use .....	165

## Care products

BMW Motorrad recommends that you use the cleaning and care products you can obtain from your authorised BMW Motorrad dealer.

The substances in BMW CareProducts have been tested in laboratories and in practice; they provide optimised care and protection for the materials used in your vehicle.



### ATTENTION

#### Use of unsuitable cleaning and care products.

Damage to vehicle parts.

- Do not use solvents such as cellulose thinners, cold cleaners, fuel or the like, and do not use cleaning products that contain alcohol. ◀

## Washing the vehicle

BMW Motorrad recommends that you use BMW insect remover to soften and wash off insects and stubborn dirt on painted parts prior to washing the vehicle.

To prevent stains, do not wash the vehicle immediately after it has been exposed to strong sunlight and do not wash it in the sun.

Make sure that the vehicle is washed frequently, especially during the winter months.

To remove road salt, clean the motorcycle with cold water immediately after every trip.



### WARNING

#### Wet brake discs and brake pads after vehicle wash, after riding through water and in rainy conditions.

Diminished braking effect.

- Apply the brakes in good time to allow the friction and heat to dry the brake discs and brake pads. ◀



### ATTENTION

#### Effect of road salt intensified by warm water.

Corrosion

- Use only cold water to wash off road salt. ◀



### ATTENTION

#### Damage due to high water pressure from high pressure cleaners or steam cleaners.

Corrosion or short-circuit, damage to seals, to the hydraulic brake system, to the electrics and the seat.

- Exercise restraint when using a steam jet or high-pressure cleaning equipment. ◀



## NOTICE

Aluminium cases and topcases do not have a surface coating. Care in accordance with the instructions set out below will help ensure the best possible appearance:

Remove road salt and corrosive deposits by cleaning with cold water immediately after every trip.◀

## Cleaning easily damaged components

### Plastics



## ATTENTION

### Use of unsuitable cleaning agents.

Damage to plastic surfaces.

- Do not use cleaning agents that contain alcohol, solvents or abrasives.

- Do not use insect-remover pads or cleaning pads with hard, scouring surfaces.◀

### Body panels

Clean the trim panels with water and BMW plastic care emulsion.

### Windscreens and lenses made of plastic

Clean off dirt and insects with a soft sponge and plenty of water.



## NOTICE

Soften stubborn dirt and insects by covering the affected areas with a wet cloth.◀



Clean with water and sponge only.



Do not use any chemical cleaning agents.

## Chrome

Use plenty of water and BMW shampoo to clean chrome, particularly if it has been exposed to road salt. Use chrome polish for additional treatment.

## Radiator

Clean the radiator regularly to prevent overheating of the engine due to inadequate cooling. For example, use a garden hose with low water pressure.



## ATTENTION

### Radiator fins easily bent.

Damage to radiator fins.

- Take care not to bend the radiator fins when cleaning.◀

## Rubber components

Treat rubber components with water or BMW rubber-care products.



## Restoring motorcycle to use

- Remove the protective wax coating.
- Clean the motorcycle.
- Installing battery (▣▶ 144).
- Comply with checklist (▣▶ 89).





## Technical data

Troubleshooting chart .....	168	Weights.....	182
Threaded fasteners .....	169	Riding specifications .....	182
Engine .....	171		
Fuel.....	172		
Engine oil .....	173		
Clutch .....	173		
Transmission .....	174		
Rear-wheel drive.....	174		
Running gear .....	175		
Brakes .....	176		
Wheels and tyres .....	177		
Electrics .....	179		
Frame .....	180		
Anti-theft alarm .....	181		
Dimensions .....	181		

## Troubleshooting chart

Engine does not start or is difficult to start.

<b>Possible cause</b>	<b>Rectification</b>
Side stand extended and gear engaged	Retract the side stand.
Gear engaged and clutch not disengaged	Select neutral or pull the clutch lever.
No fuel in tank	Refuelling (▮▮▮▶ 98).
Battery flat	Charge battery when connected (▮▮▮▶ 142).

## Threaded fasteners

Front wheel	Value	Valid
<b>Quick-release axle in telescopic forks</b>		
M12 x 20	30 Nm	
<b>Clamping screw for quick-release axle in telescopic fork</b>		
M8 x 35	19 Nm	
<b>Brake caliper on telescopic fork</b>		
M10 x 65	38 Nm	
Rear wheel	Value	Valid
<b>Rear wheel to wheel flange</b>		
M10 x 1.25 x 40	<b>Tighten in diagonally opposite sequence</b>	
	60 Nm	
<b>Wheel-speed sensor to fork leg</b>		
M6 x 16 Micro-encapsulated or medium-strength thread-locking compound	8 Nm	

<b>Mirror arm</b>	<b>Value</b>	<b>Valid</b>
<b>Mirror (lock nut) to adapter</b>		
Left-hand thread, M10 x 1.25	22 Nm	
<b>Adapter to clamping block</b>		
M10 x 14 - 4.8	25 Nm	
<b>Handlebars</b>	<b>Value</b>	<b>Valid</b>
<b>Clamping block (handlebar clamp) on fork bridge</b>		
M8 x 35	<b>Tighten in riding direction at the front of the block</b>	
	19 Nm	

## Engine

Location of engine number	Crankcase, bottom right, below starter motor
Engine design	Air-/liquid-cooled two-cylinder four-stroke opposed-twin engine with two overhead spur-gear-driven camshafts and one balancing shaft
Displacement	1170 cm <sup>3</sup>
Cylinder bore	101 mm
Piston stroke	73 mm
Compression ratio	12.5:1
Nominal output	92 kW, at engine speed: 7750 min <sup>-1</sup>
– with power reduction <sup>OE</sup>	79 kW, at engine speed: 7750 min <sup>-1</sup>
Torque	125 Nm, at engine speed: 6500 min <sup>-1</sup>
– with power reduction <sup>OE</sup>	122 Nm, at engine speed: 5250 min <sup>-1</sup>
Maximum engine speed	max 9000 min <sup>-1</sup>
Idle speed	1150 min <sup>-1</sup> , Engine at regular operating temperature

## Fuel

Recommended fuel grade	Super unleaded (max. 10 % ethanol, E10) 95 ROZ/RON 89 AKI
Alternative fuel grade	Regular unleaded (Power- and consumption-related restrictions. If e.g. the engine is to be operated in countries with low fuel grades at 91 research octane number, then the motorcycle must first be programmed appropriately at your authorised BMW motorcycle dealer.) (max. 10 % ethanol, E10) 91 ROZ/RON 87 AKI
Usable fuel capacity	approx. 20 l
Reserve fuel	approx. 4 l
Exhaust emissions standard	EU 3

## Engine oil

Engine oil, capacity	max 4 l, with filter change
Specification	SAE 5W-40, API SL / JASO MA2, Additives (e.g. molybdenum-based) are not permissible because they can attack coated components of the engine, BMW Motorrad recommends BMW Motorrad ADVANTEC Ultimate oil
Engine oil, quantity for topping up	max 0.95 l, Difference between MIN and MAX

**BMW recommends** **ADVANTEC**  
ORIGINAL BMW ENGINE OIL

## Clutch

Clutch type	Multiplate oil-bath clutch, anti-hopping
-------------	--

## Transmission

Gearbox type	Dog-shifted six-speed gearbox with bevel gearing
Gearbox transmission ratios	1.000 (60:60 teeth), Primary transmission ratio 1.650 (33:20 teeth), Transmission input ratio 2.438 (39:16 teeth), 1st gear 1.714 (36:21 teeth), 2nd gear 1.296 (35:27 teeth), 3rd gear 1.059 (36:34 teeth), 4th gear 0.943 (33:35 teeth), 5th gear 0.848 (28:33 teeth), 6th gear 1.061 (35:33 teeth), Transmission output ratio

## Rear-wheel drive

Type of final drive	Shaft drive with bevel gears
Type of rear suspension	Cast aluminium single swinging arm with BMW Motorrad paralever
Gear ratio of final drive	2.91 (32/11 teeth)



## Running gear

### Front wheel

Type of front suspension	BMW Telelever, with anti-dive top fork bridge, leading link pivot-mounted on engine and telescopic forks, central spring strut supported by leading link and frame
Design of front wheel suspension	Central shock absorber with helical spring
– with Dynamic ESA <sup>OE</sup>	Central shock absorber complete with torsion spring and header tank, electrically adjustable de-compression and compression-stage damping
Spring travel, front	190 mm, at wheel
– with lowered suspension <sup>OE</sup>	160 mm, at wheel

**Rear wheel**

Type of rear suspension	Cast aluminium single swinging arm with BMW Motorrad paralever
Type of rear suspension	Central spring strut with coil spring, adjustable rebound stage damping and spring preload
– with Dynamic ESA <sup>OE</sup>	Central spring strut with coil spring and reservoir, electrically adjustable rebound-.stage and compression-stage damping, electrically adjustable spring preload
Spring travel at rear wheel	200 mm
– with lowered suspension <sup>OE</sup>	170 mm

**Brakes**

Type of front brake	Hydraulically actuated twin-disc brake with 4-piston radial monobloc calipers and floating brake discs
Brake-pad material, front	Sintered metal
Brake disc thickness, front	min 4 mm, Wear limit
Type of rear brake	Hydraulically operated disc brake with 2-piston floating caliper and fixed disc
Brake-pad material, rear	Organic material

Brake disc thickness, rear	min 4.5 mm, Wear limit
----------------------------	------------------------

## Wheels and tyres

Recommended tyre sets	Your authorised BMW Motorrad dealer will be happy to supply an up-to-date list of the approved wheel/tyre combinations, or you can check the information posted on the <a href="http://bmw-motorrad.com">bmw-motorrad.com</a> website.
Speed category, front/rear tyres	V, required at least: 240 km/h

### Front wheel

Front wheel type	Aluminium cast wheel
– with cross-spoked wheels <sup>OE</sup>	Cross-spoked wheel
Front wheel rim size	3.0"x19"
Tyre designation, front	120/70 - 19
Load index, front tyre	min. 52
Permissible front-wheel imbalance	max 5 g

**Rear wheel**

Rear-wheel type	Aluminium cast wheel
– with cross-spoked wheels <sup>OE</sup>	Cross-spoked wheel
Rear wheel rim size	4.50"x17"
Tyre designation, rear	170/60 - 17
Load index, rear tyre	min. 70
Permissible rear-wheel imbalance	max 45 g

**Tyre pressures**

Tyre pressure, front	2.5 bar, tyre cold
Tyre pressure, rear	2.9 bar, tyre cold

## Electrics

Electrical rating of on-board sockets	max 5 A, total for all sockets
Fuse carrier 1	10 A, Slot 1: Instrument cluster, anti-theft alarm (DWA), ignition lock, diagnostic socket 7.5 A, Slot 2: Left multifunction switch, tyre pressure monitoring (RDC)
Fuse holder	50 A, Fuse 1: Voltage regulator

### Battery

Battery type	AGM (Absorbent Glass Mat) battery
Battery rated voltage	12 V
Battery rated capacity	12 Ah

### Spark plugs

Spark plugs, manufacturer and designation	NGK LMAR8D-J
Electrode gap of spark plug	0.8 $\pm$ 0.1 mm, when new 1.0 mm, Wear limit

### Lighting

Bulb for high-beam headlight	H7 / 12 V / 55 W
– with LED headlights <sup>OE</sup>	LED
Bulbs for the low-beam headlight	H7 / 12 V / 55 W
– with LED headlights <sup>OE</sup>	LED

Bulb for parking light	W5W / 12 V / 5 W
– with LED headlights <sup>OE</sup>	LED
Bulb for tail light/brake light	LED
Bulbs for flashing turn indicators, front	RY10W / 12 V / 10 W
– with LED turn indicators <sup>OE</sup>	LED
Bulbs for flashing turn indicators, rear	RY10W / 12 V / 10 W
– with LED turn indicators <sup>OE</sup>	LED

## Frame

Frame type	Tubular steel frame with supporting drive unit, steel pipe rear frames
Type plate location	Frame, front right (beside spring strut)
Position of the Vehicle Identification Number	Frame, front right, on steering head

## Anti-theft alarm

Activation time on arming	approx. 30 s
Alarm duration	approx. 26 s
Battery type	CR 123 A

## Dimensions

Length of motorcycle	2205 mm, over spray guard
Height of motorcycle	1430...1490 mm, over windscreen, at DIN unladen weight
– with lowered suspension <sup>OE</sup>	1405...1465 mm, to top of windscreen when lowered, at DIN unladen weight
Width of motorcycle	955 mm, with mirrors
Front-seat height	850...870 mm, without rider at unladen weight
– with front seat, low <sup>OE</sup>	820...840 mm, without rider at unladen weight
– with lowered suspension <sup>OE</sup>	800...820 mm, without rider at unladen weight
Rider's inside-leg arc, heel to heel	1870...1910 mm, without rider at unladen weight
– with front seat, low <sup>OE</sup>	1820...1860 mm, without rider at unladen weight
– with lowered suspension <sup>OE</sup>	1790...1830 mm, without rider at unladen weight

## Weights

Unladen weight	238 kg, DIN unladen weight, ready for road 90 % load of fuel, without OE
Permissible gross weight	450 kg
Maximum payload	212 kg

## Riding specifications

Starting capability on uphill gradients (at permissible gross weight)	20 %
Top speed	>200 km/h



## Service

BMW Motorrad Service .....	184
BMW Motorrad Mobility services .....	184
Maintenance work .....	184
Maintenance schedule .....	187
Standard BMW service .....	188
Confirmation of maintenance work .....	189
Confirmation of service .....	194

## BMW Motorrad Service

BMW Motorrad has an extensive network of dealerships in place to look after you and your motorcycle in more than 100 countries. Authorised BMW Motorrad dealerships have the technical information and the know-how to reliably carry out all maintenance and repair work on your BMW. Visit our website [www.bmw-motorrad.com](http://www.bmw-motorrad.com) to find out where the nearest authorised BMW Motorrad dealership is located.



### WARNING

#### **Maintenance and repair work not in compliance with correct procedure.**

Risk of accident due to subsequent damage.

- BMW Motorrad recommends you to have all the associated work on your motorcycle car-

ried out by a specialist workshop, preferably an authorised BMW Motorrad dealer. ◀

In order to help ensure that your BMW is always in optimum condition, BMW Motorrad recommends compliance with the maintenance intervals specified for your motorcycle. Have all maintenance and repair work that is carried out confirmed in the "Service" chapter in this manual. For generous treatment of claims submitted after the warranty period has expired, evidence of regular maintenance is essential.

Your authorised BMW Motorrad dealer can provide information on BMW services and the work undertaken as part of each service.

## BMW Motorrad Mobility services

As owner of a new BMW motorcycle, in circumstances in which assistance is required you can benefit from the protection afforded by the various BMW Motorrad mobility services (e.g. Mobile Service, breakdown service, vehicle recovery service). Your authorised BMW Motorrad dealer will be happy provide information about the mobility services available to you.

### Maintenance work

#### **BMW Pre-delivery Check**

Your authorised BMW Motorrad dealer conducts the BMW pre-delivery check before handing over the vehicle to you.

## BMW Running-in Check

The BMW running-in check has to be performed when the vehicle has covered between 500 km and 1200 km.

## BMW Service

The BMW Service is carried out once a year; the extent of servicing can vary, depending on the age of the vehicle and the distance it has covered. Your authorised BMW Motorrad dealer confirms that the service work has been carried out and enters the date when the next service will be due.

Riders who cover long distances in a year might have to bring in their vehicles for service before the next scheduled date. It is to allow for these cases that a maximum odometer reading is entered as well in the confirmation of service. Servicing has to be brought forward if this odo-

meter reading is reached before the next scheduled date for the service.

The service-due indicator in the multifunction display reminds you about one month or 1000 km in advance when the time for a service is approaching, on the basis of the programmed values.

To find out more about service go to:

**[bmw-motorrad.com/service](http://bmw-motorrad.com/service)**

The maintenance tasks necessary for your vehicle are set out in the maintenance schedule below:



## Maintenance schedule

- 1** BMW Running-in check
  - 2** Standard BMW service  
( 188)
  - 3** Engine-oil change, with filter
  - 4** Oil change in bevel gears
  - 5** Check valve clearance
  - 6** Replace all spark plugs
  - 7** Replace air-filter element
  - 8** Check or replace air-filter element
  - 9** Change brake fluid, entire system
- a** annually or every 10,000 km (whichever comes first)
- b** every 2 years or every 20,000 km (whichever comes first)
- c** if vehicle is used off-road, annually or every 10,000 km (whichever comes first)

**d** for the first time after one year, then every two years

## Standard BMW service

A standard BMW service consists of the following maintenance work:

- Perform vehicle test with the BMW Motorrad diagnosis system.
- Visually inspect the hydraulic clutch system.
- Visually inspect the brake pipes, brake hoses and connections.
- Check the front and rear brake pads and brake discs for wear.
- Check the front and rear brake-fluid levels.
- Check the coolant level.
- Check the ease of movement of the side stand.
- Check the ease of movement of the centre stand.
- Check the tyre pressures and tread depth.
- Check the spoke tension, adjust if necessary (motorcycle fitted with cross-spoked wheels as OE).
- Check the lights and signalling equipment.
- Check that the engine start suppression system is in working order.
- Perform final inspection and check of roadworthiness.
- Set the service-due date and service countdown distance.
- Check the battery charge state.
- Confirm BMW service in the on-board documentation.

## Confirmation of maintenance work

### BMW Pre-delivery Check

Completed

on \_\_\_\_\_

\_\_\_\_\_  
Stamp, signature

### BMW Running-in Check

Completed

on \_\_\_\_\_

Odometer reading \_\_\_\_\_

Next service  
at the latest

on \_\_\_\_\_

or, if logged beforehand,

Odometer reading \_\_\_\_\_

\_\_\_\_\_  
Stamp, signature

**BMW Service**

Completed

on \_\_\_\_\_

Odometer reading \_\_\_\_\_

Next service  
at the latest

on \_\_\_\_\_

or, if logged beforehand,

Odometer reading \_\_\_\_\_

\_\_\_\_\_  
Stamp, signature**BMW Service**

Completed

on \_\_\_\_\_

Odometer reading \_\_\_\_\_

Next service  
at the latest

on \_\_\_\_\_

or, if logged beforehand,

Odometer reading \_\_\_\_\_

\_\_\_\_\_  
Stamp, signature**BMW Service**

Completed

on \_\_\_\_\_

Odometer reading \_\_\_\_\_

Next service  
at the latest

on \_\_\_\_\_

or, if logged beforehand,

Odometer reading \_\_\_\_\_

\_\_\_\_\_  
Stamp, signature



**BMW Service**

Completed

on \_\_\_\_\_

Odometer reading \_\_\_\_\_

Next service  
at the latest

on \_\_\_\_\_

or, if logged beforehand,

Odometer reading \_\_\_\_\_

\_\_\_\_\_  
Stamp, signature**BMW Service**

Completed

on \_\_\_\_\_

Odometer reading \_\_\_\_\_

Next service  
at the latest

on \_\_\_\_\_

or, if logged beforehand,

Odometer reading \_\_\_\_\_

\_\_\_\_\_  
Stamp, signature**BMW Service**

Completed

on \_\_\_\_\_

Odometer reading \_\_\_\_\_

Next service  
at the latest

on \_\_\_\_\_

or, if logged beforehand,

Odometer reading \_\_\_\_\_

\_\_\_\_\_  
Stamp, signature

**BMW Service**

Completed

on \_\_\_\_\_

Odometer reading \_\_\_\_\_

Next service  
at the latest

on \_\_\_\_\_

or, if logged beforehand,

Odometer reading \_\_\_\_\_

\_\_\_\_\_  
Stamp, signature**BMW Service**

Completed

on \_\_\_\_\_

Odometer reading \_\_\_\_\_

Next service  
at the latest

on \_\_\_\_\_

or, if logged beforehand,

Odometer reading \_\_\_\_\_

\_\_\_\_\_  
Stamp, signature**BMW Service**

Completed

on \_\_\_\_\_

Odometer reading \_\_\_\_\_

Next service  
at the latest

on \_\_\_\_\_

or, if logged beforehand,

Odometer reading \_\_\_\_\_

\_\_\_\_\_  
Stamp, signature

**BMW Service**

Completed

on \_\_\_\_\_

Odometer reading \_\_\_\_\_

Next service  
at the latest

on \_\_\_\_\_

or, if logged beforehand,

Odometer reading \_\_\_\_\_

\_\_\_\_\_  
Stamp, signature**BMW Service**

Completed

on \_\_\_\_\_

Odometer reading \_\_\_\_\_

Next service  
at the latest

on \_\_\_\_\_

or, if logged beforehand,

Odometer reading \_\_\_\_\_

\_\_\_\_\_  
Stamp, signature**BMW Service**

Completed

on \_\_\_\_\_

Odometer reading \_\_\_\_\_

Next service  
at the latest

on \_\_\_\_\_

or, if logged beforehand,

Odometer reading \_\_\_\_\_

\_\_\_\_\_  
Stamp, signature

## Confirmation of service

The table is intended as a record of maintenance and repair work, the installation of optional accessories and, if appropriate, special campaign (recall) work.

Item	Odometer reading	Date

Item	Odometer reading	Date



## Appendix

Certificate for electronic immobiliser .....	198
Certificate for Keyless Ride .....	200
Certificate for tyre pressure monitoring (Reifendruck-Control, RDC) .....	202

## FCC Approval

### Ring aerial in the ignition switch



To verify the authorization of the ignition key, the electronic immobilizer exchanges information with the ignition key via the ring aerial.

This device complies with Part 15 of the FCC rules. Operation is subject to the following two conditions:

- (1) This device may not cause harmful interference, and
- (2) this device must accept any interference received, including interference that may cause undesired operation.



Any changes or modifications not expressly approved by the party responsible for compliance could void the user's authority to operate the equipment. ◀



## Approbation de la FCC

### Antenne annulaire présente dans le commutateur d'allumage



Pour vérifier l'autorisation de la clé de contact, le système d'immobilisation électronique échange des

informations avec la clé de contact via l'antenne annulaire.

Le présent dispositif est conforme à la partie 15 des règles de la FCC. Son utilisation est soumise aux deux conditions suivantes :

- (1) Le dispositif ne doit pas produire d'interférences nuisibles, et
- (2) le dispositif doit pouvoir accepter toutes les interférences extérieures, y compris celles qui pourraient provoquer une activation inopportune.



Toute modification qui n'aurait pas été approuvée expressément par l'organisme responsable de l'homologation peut annuler l'autorisation accordée à l'utilisateur pour utiliser le dispositif. ◀

## Certifications

---

### BMW Keyless Ride ID Device



#### USA, Canada

Product name: BMW Keyless Ride ID Device  
FCC ID: YGOHUF5750  
IC: 4008C-HUF5750

#### Canada:

Operation is subject to the following two conditions:

- (1) This device may not cause harmful interference, and
- (2) this device must accept any interference received, including interference that may cause undesired operation.

#### USA:

This device complies with Part 15 of the FCC rules. Operation is subject to the following two conditions:

- (1) This device may not cause harmful interference, and
- (2) this device must accept any interference received, including interference that may cause undesired operation.



Any changes or modifications not expressly approved by the party responsible for compliance could void the user's authority to operate the equipment.

# Declaration Of Conformity

---

We declare under our responsibility that the product

## **BMW Keyless Ride ID Device (Model: HUF5750)**

complies with the appropriate essential requirements of the article 3 of the R&TIE and the other relevant provisions, when used for its intended purpose. Applied Standards:

1. Health and safety requirements contained in article 3 (1) a)
  - EN 60950-1:2006+A11:2009+A1:2010+A12:2011; Information technology equipment- Safety
2. Protection requirements with respect to electromagnetic compatibility article 3 (1) b)
  - EN 301 489-1 (V1.9.2, 09/2011), Electromagnetic compatibility and radio spectrum matters (ERM); Electromagnetic compatibility (EMC) standard for radio equipment and services; Part 1: Common technical requirements
  - EN 301 489-3 (V1.4.1, 08/2002) Electromagnetic compatibility and radio spectrum matters (ERM); Electromagnetic compatibility (EMC) standard for radio equipment and services; Part 3: Specific conditions for short range devices (SRD) operating on frequencies between 9 kHz and 40 GHz
3. Means of the efficient use of the radio frequency spectrum article 3 (2)
  - EN 300 220-1 & -2 (V2.4.1, 05/2012), electromagnetic compatibility and radio spectrum matters (ERM); Short range devices (SRD); Radio equipment to be used in the 25 MHz to 1000 MHz frequency range with power levels ranging up to 500 mW;  
Part 1: Technical characteristics and test methods.  
Part 2: Harmonized EN covering essential requirements under article 3.2 of the R&TIE directive

The product is labeled with the CE marking: **CE**

Velbert, October 15<sup>th</sup>, 2013

---

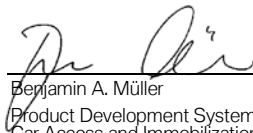

---

Benjamin A. Müller  
Product Development Systems  
Car Access and Immobilization – Electronics  
Huf Hülbeck & Fürst GmbH & Co. KG  
Steeger Straße 17, D-42551 Velbert

## Certification Tire Pressure Control (TPC)

---

FCC ID: MRXBC54MA4  
IC: 2546A-BC54MA4

FCC ID: MRXBC5A4  
IC: 2546A-BC5A4

This device complies with Part 15 of the FCC Rules and with Industry Canada license-exempt RSS standard(s).

Operation is subject to the following two conditions:

- (1) This device may not cause harmful interference, and
- (2) This device must accept any interference received, including interference that may cause undesired operation.

Le présent appareil est conforme aux CNR d'Industrie Canada applicables aux appareils radio exempts de licence. L'exploitation est autorisée aux deux conditions suivantes:

- (1) l'appareil ne doit pas produire de brouillage, et
- (2) l'utilisateur de l'appareil doit accepter tout brouillage radioélectrique subi, même si le brouillage est susceptible d'en compromettre le fonctionnement.

**WARNING:** Changes or modifications not expressly approved by the party responsible for compliance could void the user's authority to operate the equipment. The term "IC:" before the radio certification number only signifies that Industry Canada technical specifications were met.

- A**
- Abbreviations and symbols, 6
- ABS
  - Control, 15
  - Engineering details, 106
  - Operation, 65
  - Self-diagnosis, 90
  - Warnings, 36
- Accessories
  - General instructions, 148
- Actuality, 7
- Air filter
  - Position on the motorcycle, 13
  - Replace insert, 138
- Ambient temperature
  - Outside temperature warning, 30
  - Reading, 39
- Anti-theft alarm
  - Operation, 57
  - Warning, 33
- ASC
  - Control, 15
  - Engineering details, 110
  - Operation, 66
  - Self-diagnosis, 91
  - Warning, 36
- Average values
  - Resetting, 52
- B**
- Battery
  - Charging battery when connected, 142
  - Charging battery when disconnected, 143
  - Indicator light for battery charge voltage, 39
  - Installation, 144
  - Maintenance instructions, 141
  - Removal, 143
  - Technical data, 179

- Brake fluid
  - Checking fluid level, front, 120
  - Checking fluid level, rear, 121
  - Reservoir, front, 13
  - Reservoir, rear, 13
- Brake pads
  - Checking front, 118
  - Checking rear, 119
  - Running in, 92
- Brakes
  - ABS Pro in detail, 109
  - ABS Pro depending on riding mode, 94
  - Adjusting handlebar lever, 78
  - Checking operation, 118
  - Safety instructions, 93
  - Technical data, 176
- C**
- Cases, 154
- Checklist, 89
- Clock
  - Adjusting, 54

- Clutch
  - Adjusting handlebar lever, 77
  - Checking operation, 124
  - Technical data, 173
- Confirmation of maintenance work, 189
- Coolant
  - Checking fill level, 122
  - Topping up, 123
  - Warning for overtemperature, 31
- Cruise-control system
  - Operation, 71
- D**
- Damping
  - Adjuster, rear, 11
  - adjusting, 74
- Daytime riding lights
  - automatic daytime riding light, 63
  - Manual daytime riding light, 62
  - Position on the motorcycle, 11
- Dimensions
  - Technical data, 181
- DWA
  - Technical data, 181
  - Telltale light, 18
- E**
- Electrics
  - Technical data, 179
- Emergency off switch (kill switch), 17
  - Operation, 59
- Engine
  - Indicator light for engine control unit, 38
  - starting, 89
  - Technical data, 171
  - Warning for engine electronics, 31
- Engine oil
  - Checking fill level, 117
  - Filler neck, 13
  - Fill-level indicator, 13
  - Oil level, 40
  - Technical data, 173
  - Topping up, 118
- Warning for engine oil level, 38
- Equipment, 7
- ESA
  - Control, 15
  - Operation, 75
- F**
- Frame
  - Technical data, 180
- Front-wheel stand
  - Installing, 132
- Fuel
  - Filler neck, 11
  - Refuelling, 98
  - refuelling with Keyless Ride, 99, 100
  - Reserve volume, 40
  - Technical data, 172
- Fuel reserve
  - Warning, 38
- Fuses
  - Replacing, 145
  - Technical data, 179

## **G**

- General views
  - Instrument panel, 18
  - Left multifunction switch, 15
  - Left side of motorcycle, 11
  - Multifunction display, 22
  - Right multifunction switch, 17
  - Right side of vehicle, 13
  - Underneath the seat, 14
  - Warning and telltale lights, 20
  - Warning symbols, 24

## **H**

- Handlebars
  - Adjusting, 79
- Hazard warning flashers
  - Control, 15, 17
  - Operation, 65
- Headlight
  - Beam throw, 60
  - Headlight beam-throw adjustment, 11
- Headlight courtesy delay feature, 45

## Heated handlebar grips

- Control, 17
  - Operation, 79
- ## Horn, 15

## **I**

- Ignition
  - Switching off, 45
  - Switching on, 45
- Immobiliser
  - Emergency key, 49
  - Reserve key, 46
  - Warning, 30
- Instrument panel
  - Ambient-light brightness sensor, 18
  - Overview, 18

## **J**

- Jump-start, 140

## **K**

- Keyless Ride
  - Battery of the radio-operated key is empty or loss of the radio-operated key, 49
  - Electronic immobiliser EWS, 49
  - Fuel filler cap, unlocking, 99, 100
  - Lock the handlebars, 47
  - Switching off ignition, 48
  - Switching on ignition, 47
  - Warning, 30, 31
- Keys, 44, 46

## **L**

- Lighting
  - LED headlight, replacing, 138
  - Replacing bulb for high-beam headlight, 133
  - Replacing bulb for low-beam headlight, 133
  - Replacing bulb for parking light, 135
  - Replacing bulbs for front and rear turn indicators, 136

- Replacing LED auxiliary headlights, 138
- Replacing LED rear light, 138
- Technical data, 179
- Warning for faulty bulb, 32
- Lights
  - automatic daytime riding light, 63
  - Control, 15
  - Headlight flasher, operating, 61
  - High-beam headlight, operating, 61
  - Low-beam headlight, 61
  - Manual daytime riding light, 62
  - Operating auxiliary headlights, 62
  - Parking light, 61
  - Side light, 61
- Lowered suspension
  - Restrictions, 86
- Luggage
  - Instructions for loading, 86
- M**
  - Maintenance
    - General instructions, 116
    - Maintenance schedule, 187
  - Maintenance intervals, 184
  - Mirrors
    - adjusting, 80
  - Mobility services, 184
  - Motorcycle
    - Care, 161
    - Cleaning, 161
    - Lashing, 101
    - Laying up, 164
    - Parking, 95
  - Multifunction display, 18
    - Control, 15
    - Operation, 51
    - Overview, 22
    - Select display, 51
  - Multifunction switch
    - General view, left side , 15
    - General view, right side, 17
- O**
  - Odometer and tripmeters
    - Resetting, 52
  - Off-roading, 96
- P**
  - Parking, 95
  - Parking light, 61
  - Power socket
    - Notes on use, 148
    - Position on the vehicle, 13
  - Pre-Ride-Check, 90
- R**
  - RDC
    - Adhesive label for rim, 126
    - Engineering details, 112
    - Warnings, 33
  - Rear-wheel drive
    - Technical data, 174
  - Refuelling, 98
    - with Keyless Ride, 99, 100
  - Remote control
    - Replacing battery, 50
  - Rev. counter, 18



- Rider's Manual
  - Position on the vehicle, 14
- Riding mode
  - adjusting, 67
  - Control, 17
  - Engineering details, 104
- Running gear
  - Technical data, 175
- Running in, 91

## **S**

- Safety instructions
  - for brakes, 93
  - For riding, 86
- Seat
  - Position of the height adjustment, 14
- Seats
  - Adjusting seat height, 82
  - Lock, 11
  - Removing and installing, 81
- Service, 184
- Service-due indicator, 41
- Shift assistant
  - Engineering details, 105
  - Riding, 92

- Shifting gear
  - Recommendation to upshift, 42
- Spark plugs
  - Technical data, 179
- Speedometer, 18
- Spring preload
  - Adjuster, rear, 13
  - adjusting, 73
- Starting, 89
  - Control, 17
- Steering lock
  - Locking, 44

## **T**

- Technical data
  - Anti-theft alarm, 181
  - Battery, 179
  - Brakes, 176
  - Bulbs, 179
  - Clutch, 173
  - Dimensions, 181
  - Electrics, 179
  - Engine, 171
  - Engine oil, 173
  - Frame, 180
  - Fuel, 172
  - Rear-wheel drive, 174
  - Running gear, 175
  - Spark plugs, 179
  - Standards, 7
  - Transmission, 174
  - Weights, 182
  - Wheels and tyres, 177
- Telltale lights, 18
  - Overview, 20
- Toolkit
  - Contents, 116
  - Position on the vehicle, 14
- Topcase
  - Operation, 157
- Torques, 169
- Transmission
  - Technical data, 174
- Troubleshooting chart, 168
- Turn indicators
  - Control, 15
  - Control, right, 17
  - Operation, 64
- Type plate
  - Position on the vehicle, 13

Tyre pressure monitoring RDC  
Reading, 41

## Tyres

Checking inflation pressure, 78  
Checking tread depth, 124  
Pressures, 178  
Recommendation, 125  
Running in, 92  
Table of tyre pressures, 14  
Technical data, 177  
Top speed, 87

## V

### Vehicle

Restoring to use, 165

### Vehicle Identification Number

Position on the vehicle, 13

## W

### Warning lights, 18

Overview, 20

### Warnings

ABS, 36

Anti-theft alarm, 33

ASC, 36

Battery charge voltage, 39

Bulb faulty, 32

Coolant temperature, 31

Engine control unit, 38

Engine electronics, 31

Engine oil level, 38

Fuel reserve, 38

Immobiliser, 30

Mode of presentation, 25

Outside temperature  
warning, 30

Overview, 24

RDC, 33

Warnings, overview, 26

### Weights

Payload table, 14

Technical data, 182

### Wheels

Change of size, 125

Check spokes, 125

Checking rims, 124

Install the rear wheel, 131

Installing front wheel, 128

Removing front wheel, 126

Technical data, 177

### Windscreen

Adjuster, 13

adjusting, 80



Details described or illustrated in this booklet may differ from the vehicle's actual specification as purchased, the accessories fitted or the national-market specification. No claims will be entertained as a result of such discrepancies.

Dimensions, weights, fuel consumption and performance data are quoted to the customary tolerances.

The right to modify designs, equipment and accessories is reserved.

Errors and omissions excepted.

© 2015 Bayerische Motoren Werke Aktiengesellschaft  
80788 Munich, Germany  
Not to be reproduced by any means whatsoever, wholly or in part, without the written permission of BMW Motorrad, After Sales.

Original rider's manual, printed in Germany.

