



BMW Motorrad



The Ultimate
Riding Machine

Rider's Manual
R 1200 GS

Motorcycle data/dealership details

Motorcycle data

Model

Vehicle identification number

Colour code

Date of first registration

Registration number

Dealership details

Person to contact in Service department

Ms/Mr

Phone number

Dealership address/phone number (company stamp)

Welcome to BMW

We congratulate you on your choice of a motorcycle from BMW and welcome you to the community of BMW riders.

Familiarise yourself with your new motorcycle so that you can ride it safely and confidently in all traffic situations.

Please read this Rider's Manual carefully before starting to use your new BMW motorcycle. It contains important information on how to operate the controls and how to make the best possible use of all your BMW's technical features.

In addition, it contains information on maintenance and care to help you maintain your vehicle's reliability and safety, as well as its value.

If you have questions concerning your motorcycle, your authorised

BMW Motorrad dealer will gladly provide advice and assistance.

We hope that you will enjoy riding your BMW and that all your journeys will be pleasant and safe

BMW Motorrad.

01 41 8 548 431



Table of Contents

You can also consult the index at the end of this Rider's Manual if you want to find a particular topic or item of information.

1 General instructions 5

Overview 6

Abbreviations and symbols 6

Equipment 7

Technical data 7

Currency 7

2 General views 9

General view, left side 11

General view, right side 13

Multifunction switch, left 14

Multifunction switch, right 16

Underneath the seat 17

Instrument panel 18

3 Status indicators 19

Multifunction display 20

Service-due indicator 21

Fuel reserve 21

Ambient temperature 22

Tyre pressures 22

Oil level 23

Recommendation to up-shift 23

Warning and telltale lights 25

Warning symbols in the display 27

Warnings 28

4 Operation 43

Ignition switch/steering lock 44

Ignition 45

Electronic immobiliser EWS 46

Multifunction display 46

Lights 53

Daytime riding lights 54

Turn indicators 56

Hazard warning flashers 56

Emergency off switch (kill switch) 57

Heated handlebar grips 57

BMW Motorrad Integral ABS 58

Automatic Stability Control ASC 59

Riding mode 60

Cruise-control system 63

Clutch 65

Brakes 65

Mirrors 66

Handlebars 67

Windscreen 67

Spring preload 67

Damping 68

Dynamic ESA, electronic suspension adjustment 69

Anti-theft alarm (DWA) 71

Tyres 73

Headlight 73

Front and rear seats 74

5 Riding 77

Safety instructions 78

Checklist 80

Starting 81

Running in 83

Off-roading	84	8 Maintenance	113	10 Technical data	147
Brakes	85	General instructions	114	Troubleshooting chart.....	148
Parking your motorcycle	86	Toolkit.....	114	Threaded fasteners	149
Refuel	86	Engine oil	115	Engine	151
Fuel grade	88	Brake system	116	Fuel	152
Secure motorcycle for trans- portation	88	Coolant.....	120	Engine oil	153
6 Engineering details.....	91	Clutch.....	122	Clutch.....	153
Riding mode	92	Rims and tyres	122	Transmission.....	154
Brake system with		Wheels	123	Rear-wheel drive	154
BMW Motorrad Integral		Front-wheel stand.....	129	Running gear.....	155
ABS	93	Bulbs.....	130	Brakes	157
Electronic engine manage- ment with BMW Motorrad		Air filter.....	135	Wheels and tyres.....	157
ASC	96	Jump-start	136	Electrics.....	158
Tyre pressure monitoring		Battery	137	Anti-theft alarm.....	160
RDC.....	98	Fuses	141	Frame	160
7 Accessories	101	9 Care.....	143	Dimensions	161
General instructions	102	Care products.....	144	Weights	162
Power sockets	102	Washing motorcycle.....	144	Riding specifications	162
Cases	103	Cleaning easily damaged		11 Service	163
Topcase.....	106	components.....	144	BMW Motorrad Service ...	164
Navigation system.....	109	Paint care	145	BMW Motorrad Mobility	
		Protective wax coating	146	services	164
		Lay up motorcycle	146	Maintenance work.....	164
		Restoring motorcycle to		Confirmation of mainten-	
		use	146	ance work	166

Confirmation of service....	171
12 Appendix.....	173
Certificate	174
13 Index	175

General instructions

Overview	6
Abbreviations and symbols	6
Equipment	7
Technical data	7
Currency	7

Overview

Chapter 2 of this Rider's Manual will provide you with an initial overview of your motorcycle.

All maintenance and repair work on the vehicle is documented in Chapter 11. This record of the maintenance work you have had performed on your vehicle is a precondition for generous treatment of goodwill claims.

When the time comes to sell your BMW, please remember to hand over this Rider's Manual; it is an important part of the motorcycle.

Abbreviations and symbols



Indicates warnings that you must comply with for reasons of your safety and the safety of others, and to protect your product against damage.



Specific instructions on how to operate, control, adjust or look after items of equipment on the motorcycle.



Indicates the end of an item of information.



Instruction.



Result of an activity.



Reference to a page with more detailed information.



Indicates the end of a passage relating to specific accessories or items of equipment.



Tightening torque.



Technical data.

OE

Optional extra
The motorcycles are assembled complete with all the BMW Motorrad optional extras originally ordered.

OA

Optional accessory
You can obtain optional accessories through your authorised BMW Motorrad dealer; optional accessories have to be retrofitted to the motorcycle.

EWS

Electronic immobiliser.

DWA

Anti-theft alarm (Diebstahlwarnanlage).

ABS

Anti-lock brake system.

ASC

Automatic Stability Control.

ESA Electronic Suspension Adjustment.

RDC Tyre pressure monitoring (ReifenDruck-Control).

Equipment

When you purchased your BMW motorcycle you have chosen a model with individual equipment. This Rider's Manual describes the special equipment (OE) offered by BMW and selected optional accessories (OA). This explains why the manual may also contain descriptions of equipment which you have not ordered. Please note, too, that your motorcycle might not be exactly as illustrated in this manual on account of country-specific differences.

If your BMW should feature equipment that is not described in this Rider's Manual, then

these scopes are described in a separate Rider's Manual.

Technical data

All dimensions, weights and power ratings stated in the Rider's Manual are quoted to the standards and comply with the tolerance requirements of the Deutsches Institut für Normung e.V. (DIN). Versions for individual countries may differ.

Currency

The high safety and quality level of BMW motorcycles is ensured by continuous development work on design, equipment and accessories. Because of this, your motorcycle may differ from the information supplied in the Rider's Manual. Nor can BMW Motorrad entirely rule out errors and omissions. We hope you will appreciate that no claims can be entertained on the





basis of the data, illustrations or descriptions in this manual.

General views

General view, left side.....	11
General view, right side	13
Multifunction switch, left	14
Multifunction switch, right.....	16
Underneath the seat	17
Instrument panel	18



General view, left side

- 1** not included in the standard equipment specification
 - with daytime riding lights^{OE}Daytime riding light
( 54)
- 2** Fuel filler neck ( 86)
- 3** Seat lock ( 74)
- 4** Setting the rear damping (down at the spring strut)
( 68)

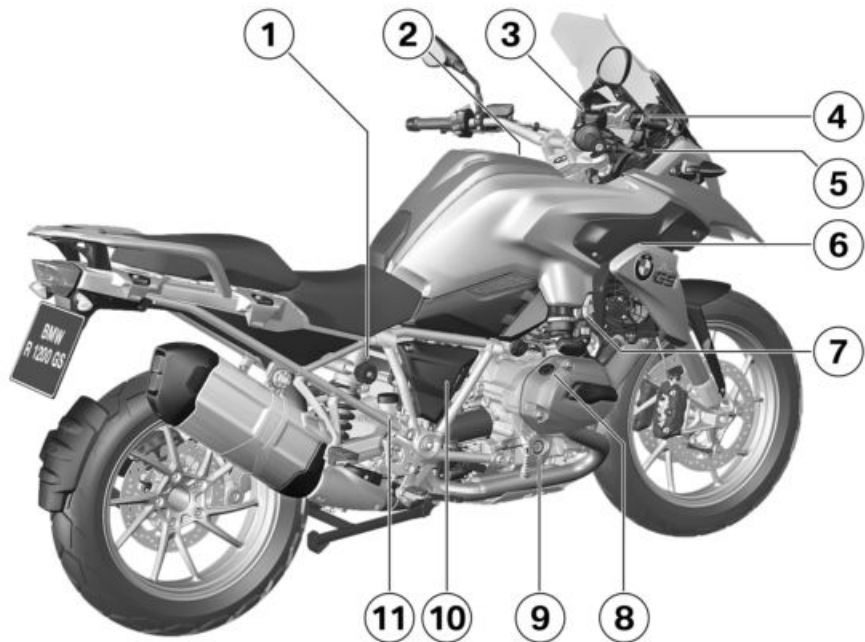

General view, right side

- 1 Adjuster for spring preload, rear (➡ 67)
- 2 Air filter (underneath the centre trim panel) (➡ 135)
- 3 Brake-fluid reservoir, front (➡ 118)
- 4 Height adjustment of the windscreen (➡ 67)
- 5 Power socket (➡ 102)
- 6 Vehicle Identification Number (VIN) (on steering-head bearing)
Type plate (on steering-head bearing)
- 7 Coolant-level indicator (➡ 120)
Coolant reservoir (➡ 121)
- 8 Engine-oil filler neck (➡ 116)
- 9 Engine oil level indicator (➡ 115)
- 10 Battery (behind the side trim panel) (➡ 137)
Battery support point (behind the side trim panel) (➡ 136)
- 11 Brake-fluid reservoir, rear (➡ 119)

Multifunction switch, left

- 1 High-beam headlight and headlight flasher (➡ 53)
- 2 not included in the standard equipment specification
– with speed control^{OE}
Cruise-control system (➡ 63)
- 3 Hazard warning flashers (➡ 56)
- 4 ABS (➡ 58)
– with riding modes^{OE}
ASC (➡ 59)
- 5 not included in the standard equipment specification
– with Dynamic ESA^{OE}
ESA (➡ 69)

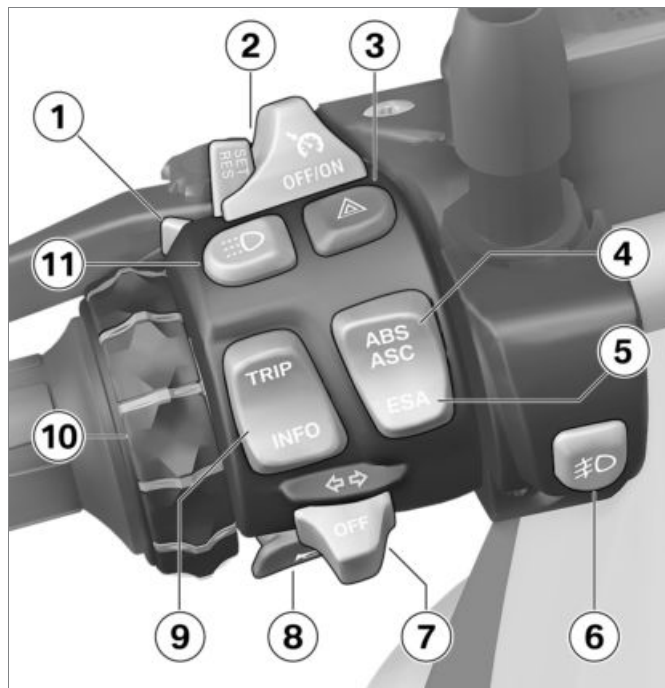

- 6** not included in the standard equipment specification
– with LED auxiliary headlight^{OA}
Auxiliary headlights (►► 54)
- 7** Turn indicators (►► 56)
- 8** Horn
- 9** Multifunction display
(►► 46)
- 10** not included in the standard equipment specification
– with preparation for navigation system^{OE}
Navigation system
(►► 109)
- 11** not included in the standard equipment specification
– with daytime riding lights^{OE}
Daytime riding lights
(►► 54)

Multifunction switch, right

- 1 not included in the standard equipment specification
 - with heated handlebar grips^{OE}Heated handlebar grips (➡ 57)
- 2 not included in the standard equipment specification
 - with riding modes^{OE}Riding mode (➡ 60)
- 3 Emergency off switch (kill switch) (➡ 57)
- 4 Start engine (➡ 81)



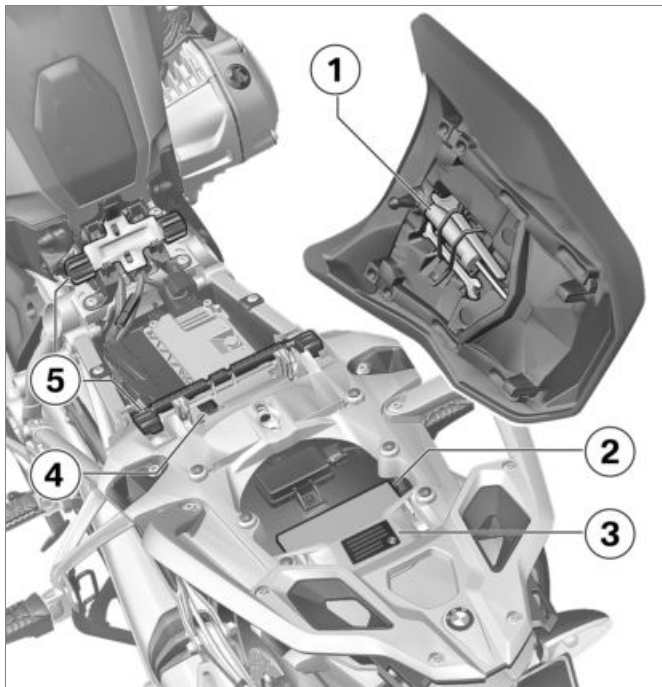

Underneath the seat

- 1 Toolkit
- 2 Rider's Manual (➡ 114)
- 3 Table of tyre pressures
- 4 Payload table
- 5 Adjusting the driver seat height (➡ 75)

Instrument panel

- 1 Speedometer
- 2 Rev. counter
- 3 Ambient-light brightness sensor (for adapting the brightness of the instrument lighting)
– with daytime riding lights^{OE}
Ambient brightness sensor for the automatic mode of the daytime riding light
– with anti-theft alarm^{OE}
- 4 Anti-theft alarm telltale light (see the instructions for use for the anti-theft alarm)
- 5 Warning and telltale lights (►► 25)
- 6 Multifunction display (►► 20)

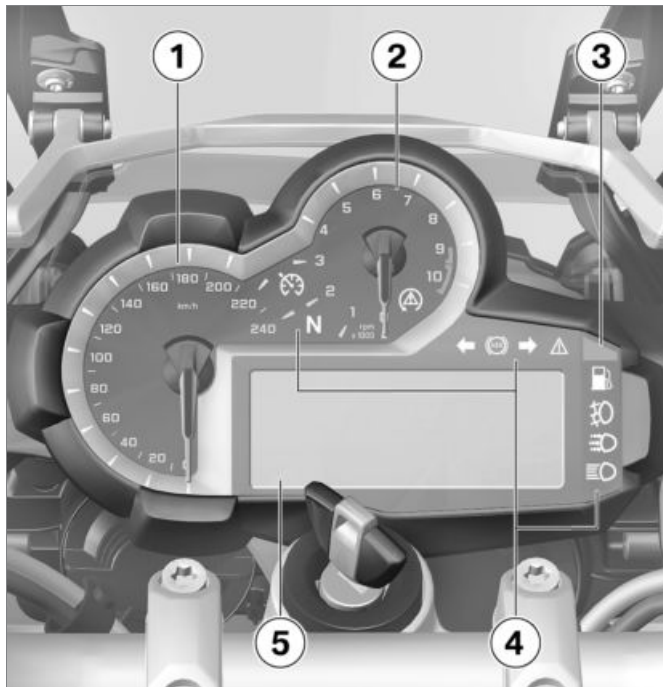

Status indicators

Multifunction display	20
Service-due indicator	21
Fuel reserve	21
Ambient temperature	22
Tyre pressures.....	22
Oil level	23
Recommendation to upshift	23
Warning and telltale lights.....	25
Warning symbols in the display	27
Warnings	28

Multifunction display

- 1 Fuel-gauge reading
- 2 Recommendation to up-shift (➡ 23)
- 3 Gear indicator; "N" indicates neutral.
- 4 not included in the standard equipment specification
 - with daytime riding lights^{OE}
 - Automatic daytime riding light (➡ 54)
- 5 not included in the standard equipment specification
 - with heated handlebar grips^{OE}
 - Grip heating stage
- 6 Indicator range of the milometer
Display of the SETUP settings
- 7 Service-due indicator
- 8 Warning symbols

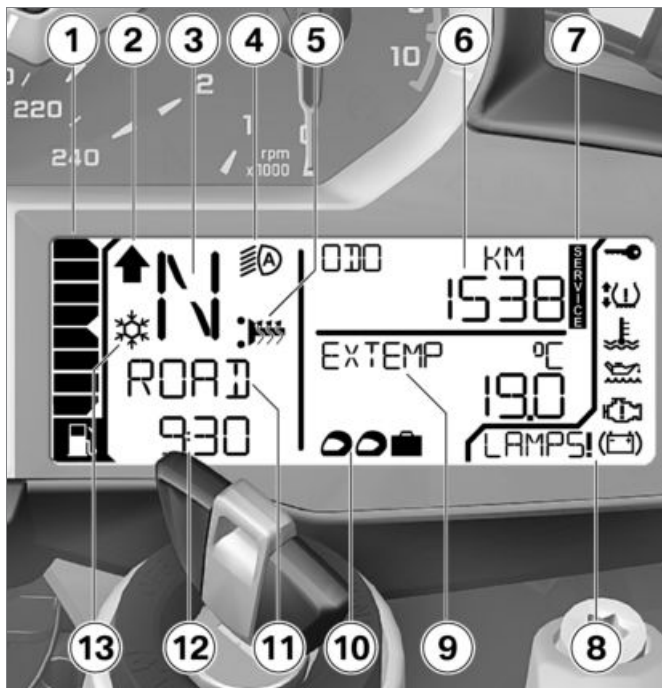

- 9 Display range of the on-board computer
Display of the SETUP settings
- 10 not included in the standard equipment specification
– with Dynamic ESA^{OE}
Display of the ESA settings
- 11 not included in the standard equipment specification
– with riding modes^{OE}
Display of the active riding mode
- 12 Clock
- 13 Outside temperature warning

Service-due indicator



If the time remaining to the next service is less than a month or if the next service falls due within 1000 km, then the service date **1** and the remaining kilometres **2** are displayed briefly after the pre-ride check.



If service is overdue, the due date or the odometer reading at which service was due is accompanied by the 'General' warning light showing yellow. The word "Service" remains permanently visible.



If the service-due indicator appears more than a month before the service date, the date saved in the instrument cluster must be adjusted. This situation can occur if the battery was disconnected. ◀

Fuel reserve

The amount of fuel present in the fuel tank when the fuel warning light is switched on is dependent on vehicle dynamics. The more the fuel moves inside the tank (due to regularly changing angles of heel, frequent braking and acceleration), the more difficult it becomes to determine the reserve volume. For this reason, the fuel reserve volume cannot be displayed exactly.



After the fuel warning light has switched on, the range is displayed automatically.

The distance that can still be travelled using the reserve volume depends on the style of driving (usage) and the amount of fuel remaining at the time the light came on.

Ambient temperature

When the motorcycle is at a standstill the heat of the engine can falsify the ambient-temperature reading. If the effect of the engine's heat becomes excessive, -- temporarily appears on the display.



At ambient temperatures below 3 °C there is a risk of ice forming. When this temperature threshold is underrun for the first time, there will be an automatic switchover to the ambient temperature display **1**, independent of the actual display setting; the displayed value flashes.



In addition, the ice crystal symbol **2** is shown.

Tyre pressures

– with tyre pressure monitoring (RDC)^{OE}



The tyre-pressure readings are based on a reference tyre temperature of 20 °C. The front tyre pressure is on the left **1**; the reading on the right **2** is the rear tyre pressure. -- --
 – appears directly after the ignition is switched on, because the sensors do not transmit tyre pressures until the first time the motorcycle accelerates to more than 30 km/h.

 If the symbol **3** also shows, this is a warning. The critical tyre pressure flashes.

 If the critical value is close to the limit of the permissible tolerance range, the reading is accompanied by the 'General' warning light showing yellow. If the tyre pressure registered by the sensor is outside the permissible tolerance range, the 'General' warning light flashes red.

The detailed description of BMW Motorrad RDC starts on page (➡ 98).

Oil level



Oil-level indicator **1** gives you an indication of the engine oil level. You can call up this reading only when the vehicle is at a standstill.

The preconditions for the oil level check are as follows:

- Engine at operating temperature.
- Engine idling for at least ten seconds.
- Side stand retracted.
- Make sure the motorcycle is upright.

The readings mean:
OK: Oil level is correct.
CHECK: Check the oil level the next time you stop for fuel.
---: Oil level cannot be measured (conditions as stated above not satisfied).

 If the oil level needs to be checked, the symbol **2** is displayed until the oil level is detected as being correct again.

Recommendation to upshift

The upshift recommendation must be activated in the display settings (➡ 48).



The upshift recommendation **1** signals the economically best point in time for upshift.

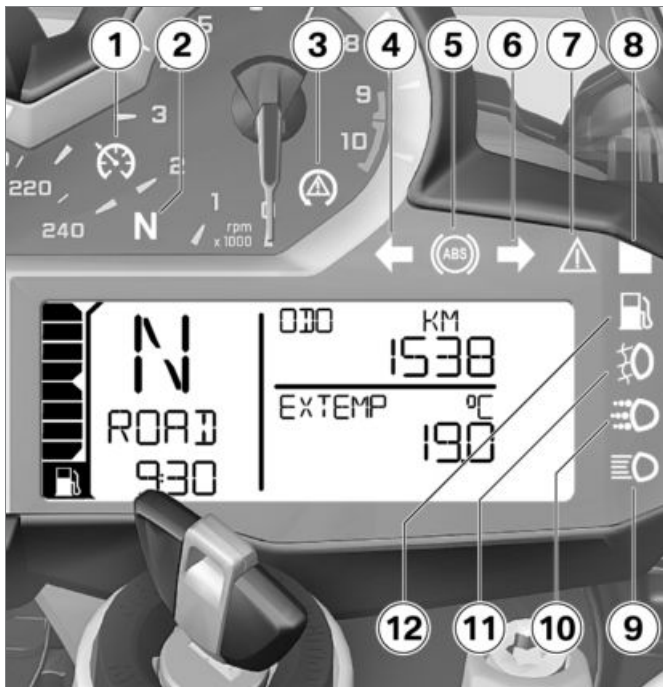

Warning and telltale lights

- 1 not included in the standard equipment specification
 – with speed control^{OE}
 Cruise-control system
- 2 Idle
- 3 not included in the standard equipment specification
 – with riding modes^{OE}
 ASC
- 4 Flashing turn indicators, left
- 5 ABS
- 6 Flashing turn indicators, right
- 7 General warning light, in combination with warning symbols in the display (→ 28)

- 8** not included in the standard equipment specification
– with anti-theft alarm^{OE}
Alarm system (see separate operating instructions)
- 9** High-beam headlight
- 10** not included in the standard equipment specification
– with daytime riding lights^{OE}
Daytime riding lights
- 11** not included in the standard equipment specification
– with LED auxiliary headlight^{OA}
Auxiliary headlights
- 12** Fuel reserve



The ABS symbol might differ, depending on the specifics of national regulations.◀

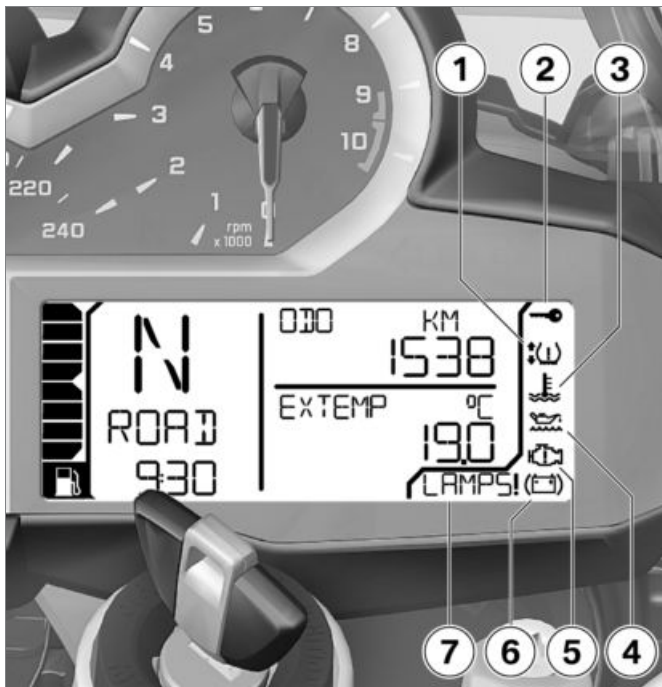

Warning symbols in the display

- 1 not included in the standard equipment specification
– with tyre pressure monitoring (RDC)^{OE}
Tyre pressure (➡ 38)
- 2 EWS (➡ 33)
- 3 Coolant temperature (➡ 34)
- 4 Engine oil level (➡ 34)
- 5 Engine electronics (➡ 33)
- 6 Battery charge (➡ 138)
- 7 Warnings (➡ 28)

Warnings

Presentation of the warning lights

Warnings are indicated by the corresponding warning lights.













Warnings that do not have warning lights of their own are indicated by 'General' warning light **1** showing in combination with a warning symbol at **2** or a text warning at **3**. The 'General' warning light shows red or yellow, depending on the urgency of the warning.

The status of the 'General' warning light matches the most urgent warning.

The possible warnings are listed on the next page.

Warnings, overview









Warning and telltale lights

	Warning symbols on the display	Meaning
 Lights up yellow	 Appears on the display	Electronic immobiliser active (▣▣▣ 33)
 Lights up		Fuel down to reserve (▣▣▣ 33)
 Lights up yellow	 Appears on the display	Engine in emergency-operation mode (▣▣▣ 33)
 Flashes yellow	 Flashes	Severe fault in the engine control unit (▣▣▣ 34)
	 Appears on the display	Engine-oil level too low (▣▣▣ 34)
	OILLVL CHECK appears on the display	
 Lights up red	 Temperature symbol appears on the display	Coolant temperature too high (▣▣▣ 34)

Warning and telltale lights

Warning symbols on the display









Meaning

	Lights up red	 Appears on the display	Battery charge voltage insufficient (→ 35)
	Lights up yellow	LAMP_! appears on the display	Bulb defective (→ 35)
	Lights up yellow	LAMPF! appears on the display	Daytime riding light faulty (→ 35)
		 Appears on the display	Outside temperature warning (→ 36)
	Flashes		ABS self-diagnosis not completed (→ 36)
	Lights up		ABS deactivated (→ 36)
	Lights up		ABS fault (→ 36)
	Quick-flashes		ASC intervention (→ 37)

Warning and telltale lights

Warning symbols on the display



Meaning

	Slow-flashes		ASC self-diagnosis not completed (▣▣▣▣ 37)
	Lights up		ASC deactivated (▣▣▣▣ 37)
	Lights up		ASC fault (▣▣▣▣ 37)
	Lights up yellow		is displayed with one or two arrows Tyre pressure close to limit of permitted tolerance (▣▣▣▣ 38)
			The critical tyre pressure flashes
	Flashes red		is displayed with one or two arrows Tyre pressure outside permitted tolerance (▣▣▣▣ 38)
			The critical tyre pressure flashes
			"--" or "-- --" is displayed
	Lights up yellow		is displayed with one or two arrows Sensor defective or system error (▣▣▣▣ 39)

Warning and telltale lights

Warning symbols on the display

Meaning

		"--" or "-- --" is displayed	Sensor defective or system error (➡ 39)
	Lights up yellow	RDC ! appears on the display	Battery of tyre-pressure sensor weak (➡ 40)
		DWALO ! appears on the display	Anti-theft alarm battery weak (➡ 40)
	Lights up yellow	DWA ! appears on the display	Anti-theft alarm battery flat (➡ 40)

Electronic immobiliser active



The "General" warning light shows yellow.



The electronic immobiliser warning symbol is displayed.

Possible cause:

The key being used is not authorised for starting, or communication between key and engine electronics is disrupted.

- Remove all other vehicle keys from the same ring as the ignition key.
- Use spare key.
- Have the defective key replaced, preferably by an authorised BMW Motorrad dealer.

Fuel down to reserve



The fuel warning light illuminates.



A shortage of fuel can result in misfires. This can cause the engine to switch off unexpectedly (risk of accident) and damage the catalytic converter.

Do not run the fuel tank dry. ◀

Possible cause:

The fuel tank contains no more than the reserve quantity of fuel.

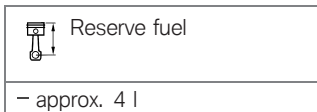

- Refuel (▶▶▶ 86).

Engine in emergency-operation mode



The "General" warning light shows yellow.



The engine symbol appears on the display.



The engine is running in emergency operating mode. Unusual engine response is a possibility.

Adapt your style of riding accordingly. Avoid accelerating sharply and overtaking. ◀

Possible cause:

The engine control unit has diagnosed a fault. In exceptional cases, the engine stops and refuses to start. Otherwise, the engine runs in emergency operating mode.

- You can continue to ride, but bear in mind that the usual engine performance might not be available.
- Avoid high load and rpm ranges if possible.
- Have the fault rectified as quickly as possible by a specialist workshop, preferably an authorised BMW Motorrad dealer.

Severe fault in the engine control unit



General warning light flashes yellow.



The engine symbol flashes.



The engine is running in emergency operating mode.

Unusual engine response is a possibility.

Adapt your style of riding accordingly. Avoid accelerating sharply and overtaking. ◀

Possible cause:

The engine control unit has diagnosed a fault which may cause severe secondary faults. Otherwise, the engine runs in emergency operating mode.

- It is possible to continue to ride but not recommended.
- Avoid high load and rpm ranges if possible.

- Have the fault rectified as quickly as possible by a specialist workshop, preferably an authorised BMW Motorrad dealer.

Engine-oil level too low



The oil can symbol appears on the display.

OILLVL CHECK appears on the display.

Possible cause:

The electronic oil-level sensor has registered an excessively low oil level. The next time you stop for fuel:

- Check engine oil level (▣▣▣ 115). If the oil level is too low:
- Top up the engine oil (▣▣▣ 116). If the oil level is correct:
- Seek the advice of a specialist workshop, preferably an authorised BMW Motorrad dealer.

Coolant temperature too high



The "General" warning light shows red.



Temperature symbol appears on the display.



Riding when the engine is overheated could result in engine damage.

Compliance with the information set out below is essential. ◀

Possible cause:

The coolant temperature is too high.

- If possible, ride in the part-load range to cool down the engine.
- If the coolant temperature is frequently too high, have the fault rectified as soon as possible by a specialist workshop, preferably an authorised BMW Motorrad dealer.

Battery charge voltage insufficient



The "General" warning light shows red.



The battery symbol appears on the display.



A discharged battery can render various systems unavailable, for example the lights, the engine or the ABS. This can result in dangerous situations. If possible, do not continue your journey.◀

Battery is not being charged. If you continue to ride the motorcycle the on-board electronics will drain the battery.

Possible cause:

Alternator or alternator drive defective.

- Have the fault rectified as quickly as possible by a specialist workshop, preferably

an authorised BMW Motorrad dealer.

Bulb defective



The "General" warning light shows yellow.

LAMP _ ! appears on the display.

- LAMPR !: Brake light, rear light, indicator light rear or license plate light faulty.
- LAMPF !: Low-beam headlight, high-beam headlight, parking light or front flashing turn indicator defective.
- LAMPS !: Several bulbs defective.



A defective bulb places your safety at risk because it is easier for other users to oversee the motorcycle.

Replace defective bulbs at the earliest possible opportunity.◀

Possible cause:

One or several bulbs are defective.

- Determine defective bulbs by visual inspection.
- Replace defective bulbs.

Daytime riding light faulty

– with daytime riding lights^{OE}



The "General" warning light shows yellow.

– LAMPF !: Additionally: daytime riding light faulty.



A defective bulb places your safety at risk because it is easier for other users to oversee the motorcycle. Replace defective bulbs at the earliest possible opportunity.◀

Possible cause:

One or several bulbs are defective.

- Determine defective bulbs by visual inspection.
- Replace defective bulbs.

Outside temperature warning



The ice-crystal symbol appears on the display.

Possible cause:

The air temperature measured at the vehicle is lower than 3 °C.



The ambient temperature warning does not mean that there is no risk of ice forming at measured temperatures above 3 °C.

Always take extra care when temperatures are low; remember that the danger of black ice forming is particularly high on bridges and where the road is in shade.◀

- Ride carefully and think well ahead.

ABS self-diagnosis not completed



The ABS warning light flashes.

Possible cause:

Self-diagnosis did not complete, so the ABS function is not available. The motorcycle must be ridden at a speed of at least 5 km/h in order for ABS self-diagnosis to complete.

- Pull away slowly. Bear in mind that the ABS function is not available until self-diagnosis has completed.

ABS deactivated



The ABS warning light comes on.

Possible cause:

The rider has switched off the ABS system.

- Activate the ABS function.

ABS fault



The ABS warning light comes on.

Possible cause:

The ABS control unit has detected a fault. The ABS function is not available.

- You can continue to ride the vehicle, but make due provision for the fact that the ABS function is not available. Bear in mind the more detailed information on situations that can lead to an ABS fault (► 95).
- Have the fault rectified as quickly as possible by a specialist workshop, preferably an authorised BMW Motorrad dealer.

ASC intervention

– with riding modes^{OE}



The ASC warning light flashes fast.

Possible cause:

ASC has detected a degree of instability at the rear wheel and has intervened to reduce torque. The warning light flashes for longer than ASC intervention lasts. This affords the rider visual feedback on control intervention even after the critical situation has been dealt with.

- You can continue to ride. Ride carefully and think well ahead.

ASC self-diagnosis not completed

– with riding modes^{OE}



The ASC warning light flashes slowly.

Possible cause:

The ASC function is not available, because self-diagnosis did not complete. The motorcycle has to move forward at a speed of at least 5 km/h for the wheel sensors to be tested.

- Pull away slowly. The ASC warning light must go out within a few metres.
- If the ASC warning light continues to flash:
- Seek the advice of a specialist workshop, preferably an authorised BMW Motorrad dealer.

ASC deactivated

– with riding modes^{OE}



The ASC warning light illuminates.

Possible cause:

The rider has switched off the ASC system.

- Switch on the ASC function.

ASC fault

– with riding modes^{OE}



The ASC warning light illuminates.

Possible cause:

The ASC control unit has detected a fault. The ASC function is not available.

- You can continue to ride. Bear in mind that the ASC function is not available. Bear in mind the more detailed information on situations that can lead to an ASC fault (► 97).
- Have the fault rectified as quickly as possible by a specialist workshop, preferably an authorised BMW Motorrad dealer.

Tyre pressure close to limit of permitted tolerance

– with tyre pressure monitoring (RDC)^{OE}



The "General" warning light shows yellow.



The tyre symbol with one or two arrows appears in the display.

The critical tyre pressure flashes. The up arrow indicates a front-tyre pressure problem, the down arrow indicates a rear-tyre pressure problem.

Possible cause:

Measured tyre pressure is close to the limit of permitted tolerance.

- Correct the tyre pressure as stated on the inside cover of the Rider's Manual.



Before you adjust tyre pressure, read the information on temperature compensation and adjusting pressure in the section entitled "Engineering details".◀

Tyre pressure outside permitted tolerance

– with tyre pressure monitoring (RDC)^{OE}



The "General" warning light flashes red.



The tyre symbol with one or two arrows appears in the display.

The critical tyre pressure flashes. The up arrow indicates a front-tyre pressure problem, the down arrow indicates a rear-tyre pressure problem.

Possible cause:

Measured tyre pressure is outside permitted tolerance.

- Check the tyre for damage and to ascertain whether the vehicle can be ridden with the tyre in its present condition.

If the vehicle can be ridden with the tyre in its present condition:



Incorrect tyre pressures impair the motorcycle's handling characteristics.

If tyre pressure is incorrect it is essential to adapt your style of riding accordingly.◀

- Correct the tyre pressure at the earliest possible opportunity.



Before you adjust tyre pressure, read the information on temperature compensation and adjusting pressure in the section entitled "Engineering details".◀

- Have the tyre checked for damage by a specialist

workshop, preferably an authorised BMW Motorrad dealer.

If you are unsure whether the vehicle can be ridden with the tyre in its present condition:

- Do not continue your journey.
- Notify the breakdown service.

Signal transmission disrupted

– with tyre pressure monitoring (RDC)^{OE}

"---" or "-- ---" is displayed.

Possible cause:

The vehicle has not yet accelerated past the threshold of approximately 30 km/h. The RDC sensors do not start transmitting signals until the vehicle reaches a speed above this threshold for the first time (► 98).

- Increase speed above this threshold and observe the RDC readings. Assume that a per-

manent fault has not occurred unless the 'General' warning light comes on to accompany the symptoms. Under these circumstances:

- Have the fault rectified by a specialist workshop, preferably an authorised BMW Motorrad dealer.

Possible cause:

Wireless communication with the RDC sensors has been disrupted.

Possible causes include radio-communication systems operating in the vicinity and interfering with the link between the RDC control unit and the sensors.

- Move to another location and observe the RDC readings. Assume that a permanent fault has not occurred unless the 'General' warning light comes on to accompany the symptoms. Under these circumstances:

- Have the fault rectified by a specialist workshop, preferably an authorised BMW Motorrad dealer.

Sensor defective or system error

– with tyre pressure monitoring (RDC)^{OE}



The "General" warning light shows yellow.



The tyre symbol with one or two arrows appears in the display.

"---" or "-- ---" is displayed.

Possible cause:

Vehicle is fitted with wheels not equipped with RDC sensors.

- Fit wheels and tyres equipped with RDC sensors.

Possible cause:

One or two RDC sensors have failed.

- Have the fault rectified by a specialist workshop, preferably an authorised BMW Motorrad dealer.

Possible cause:

A system error has occurred.

- Have the fault rectified by a specialist workshop, preferably an authorised BMW Motorrad dealer.

Battery of tyre-pressure sensor weak

– with tyre pressure monitoring (RDC)^{OE}



The "General" warning light shows yellow.

RDC ! appears on the display.



This error message appears only briefly after the pre-ride check completes.◀

Possible cause:

The integral battery in the tyre-pressure sensor has lost a significant proportion of its original capacity. There is no assurance of how long the tyre pressure control system can remain operational.

- Seek the advice of a specialist workshop, preferably an authorised BMW Motorrad dealer.

Anti-theft alarm battery weak

– with anti-theft alarm^{OE}

DWALO ! appears on the display.



This error message appears only briefly after the pre-ride check completes.◀

Possible cause:

The integral battery in the anti-theft alarm has lost a significant proportion of its original capacity. There is no assurance of how long the anti-theft alarm can remain operational if the vehicle's battery is disconnected.

- Seek the advice of a specialist workshop, preferably an authorised BMW Motorrad dealer.

Anti-theft alarm battery flat

– with anti-theft alarm^{OE}



The "General" warning light shows yellow.

DWA ! appears on the display.



This error message appears only briefly after the pre-ride check completes.◀

Possible cause:

The integral battery in the anti-theft alarm has lost its entire original capacity. There is no assurance that the anti-theft alarm will be operational if the vehicle's battery is disconnected.

- Seek the advice of a specialist workshop, preferably an authorised BMW Motorrad dealer.

Operation

Ignition switch/steering lock	44	Clutch	65
Ignition.....	45	Brakes	65
Electronic immobiliser EWS.....	46	Mirrors	66
Multifunction display	46	Handlebars	67
Lights.....	53	Windscreen	67
Daytime riding lights	54	Spring preload	67
Turn indicators.....	56	Damping.....	68
Hazard warning flashers.....	56	Dynamic ESA, electronic suspension adjustment.....	69
Emergency off switch (kill switch).....	57	Anti-theft alarm (DWA).....	71
Heated handlebar grips	57	Tyres	73
BMW Motorrad Integral ABS	58	Headlight	73
Automatic Stability Control ASC	59	Front and rear seats	74
Riding mode	60		
Cruise-control system	63		

Ignition switch/steering lock

Keys

You receive two different ignition keys and one emergency key. The emergency key is small and light so that it can always be kept in a wallet or purse, for example. It is designed for occasional use, for example when no ignition key is available; it is not intended for constant use.

Please consult the information on the electronic immobiliser (EWS) if an ignition key is lost or mislaid (►► 46).

- with cases^{OA}
- with topcase^{OA}

If you wish you can arrange to have the cases and the top-case fitted with locks that can be opened with the ignition key as well. Consult a specialist work-

shop, preferably an authorised BMW Motorrad dealer.

Lock the handlebars

 If the motorcycle is on the side stand, the surface of the ground will determine whether it is better to turn the handlebars to the left or right. However, the motorcycle is more stable on a level surface with the handlebars turned to the left than with the handlebars turned to the right. On level ground, always turn the handlebars to the left to set the steering lock. ◀

- Turn the handlebars to the full left or right lock position.

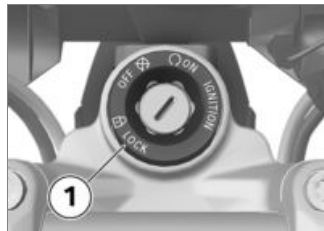

- Turn the ignition key to position **1**, while moving the handlebars slightly.
 - » Ignition, lights and all function circuits switched off.
 - » Handlebars locked.
 - » Ignition key can be removed.

Ignition

Switch on ignition

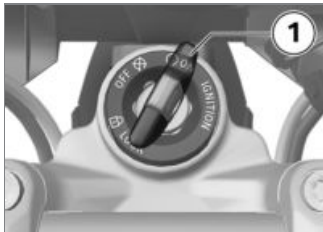

- Turn the ignition key to position **1**.
 - » Parking lights and all function circuits switched on.
 - » Engine can be started.
 - » Pre-ride check is performed. (▮▮▮ 81)
 - » ABS self-diagnosis is performed. (▮▮▮ 82)
- with riding modes^{OE}
 - » ASC self-diagnosis is performed. (▮▮▮ 82)◁

Welcome lights

- with LED headlights^{OE}
 - with daytime riding lights^{OE}
 - with LED auxiliary headlight^{OA}
- Switch on the ignition.
 - » The side lights briefly light up.
 - with daytime riding lights^{OE}
 - » The side lights and the daytime riding lights briefly light up.◁
 - with LED auxiliary headlight^{OA}
 - » The auxiliary headlights and the side lights briefly light up.◁

Switching off ignition

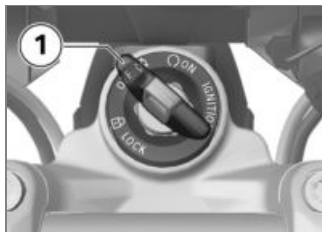

- Turn the ignition key to position **1**.
 - » Lights switched off.
 - » Handlebars not locked.
 - » Ignition key can be removed.
 - » Electrically powered accessories remain operational for a limited period of time.
 - » The battery can be recharged via the socket.
 - » When the ignition is switched off, the instrument cluster remains switched on for a short time and displays any existing fault messages.

Headlight courtesy delay feature

- with LED headlights^{OE}
 - with daytime riding lights^{OE}
 - with LED auxiliary headlight^{OA}
- Switch off the ignition.
 - with daytime riding lights^{OE}
 - » The daytime riding light and the side lights at the rear continue to be lit for a little longer.◁
 - with LED auxiliary headlight^{OA}
 - » The auxiliary headlights and the side lights at the rear continue to be lit for a little longer.◁

Electronic immobiliser EWS

The electronic design of the motorbike allows it to access data stored in the ignition key by means of a ring antenna located in the ignition switch/steering lock. The engine control unit

will not permit the engine to be started unless the key is identified as “authorised”.

 A spare key attached to the same ring as the ignition key used to start the engine could “irritate” the electronics, in which case the enabling signal for starting is not issued. The EWS warning appears in the multifunction display. Always keep the spare key separately from the ignition key.◀

If you lose your key, you can have it barred by your BMW Motorrad authorised dealer. If you wish to do this, you will need to bring all other keys for the motorbike with you. The engine cannot be started by a barred key, but a key that has been barred can subsequently be reactivated. You can obtain replacement/extra keys only through an authorised

BMW Motorrad dealer. The keys are part of an integrated security system, so the dealer is under an obligation to check the legitimacy of all applications for replacement/extra keys.

Multifunction display Selecting readings



- Briefly press button **1** in order to select the display in the top display line **2**.

In the standard equipment the following values can be displayed and selected at the press of a button:

- Total distance travelled (ODO)
- Tripmeter 1 (TRIP I)
- Tripmeter 2 (TRIP II)
- Range (RANGE)
- SETUP-menu (SETUP), only when stationary

- with on-board computer Pro^{OE}

The following information is additionally displayed by means of the on-board computer Pro:

- Automatic milometer (TRIP A)
- Current consumption (CONS C)
- Current speed (SPEED)◀



- Briefly press button **1** in order to select the display in the bottom display line **2**.

In the standard equipment the following values can be displayed and selected at the press of a button:

- Ambient temperature (EX-TEMP)
- Engine temperature (EN-GTMP)
- Average consumption 1 (CONS 1)
- Average consumption 2 (CONS 2)

- Average speed (Ø SPEED)
- with tyre pressure monitoring (RDC)^{OE}
- Tyre pressures (RDC)◀

- Date (DATE)
- Oil-level reminder (OILLVL)

- with on-board computer Pro^{OE}
- Vehicle circuit voltage (VOLTGE)◀
- with on-board computer Pro^{OE}
- Stopwatch total time (ALTIME)◀
- with on-board computer Pro^{OE}
- Stop watch driving time (RDTIME)◀

Resetting tripmeter

- Switch on the ignition.



- Repeatedly press button **1** briefly until the milometer to be reset is indicated in the top display line **2**.
- Press and hold down button **1** until the value shown is reset.

Resetting average values

- Switch on the ignition.



- Repeatedly press button **1** briefly until the average value to be reset is indicated in the bottom display line **2**.
- Press and hold down button **1** until the value shown is reset.

Configuring functions

- Switch on the ignition, or bring the motorcycle to a stop.



- Repeatedly press button **1** briefly until the top display line displays **2** SETUP ENTER.
- Press and hold button **1** to start the SETUP menu.
- » The following indication in the display depends on the equipment selected.



- Respectively press button **1** briefly in order to go to the next menu item.
 - » The top display line **2** shows the menu item.
 - » The bottom display line **3** shows the preset value.
 - Press button **4** briefly in order to change the set value.
- The following menu items can be selected:
- with anti-theft alarm^{OE}
 - DWA: Switching alarm system (ON) or (OFF)◀

- with preparation for navigation system^{OE}
- GPS TM: with an installed navigation system: taking over GPS-time and GPS date (ON) or not (OFF)◀
- CLOCK: Setting the clock
- DATE: Setting the date
- ECOSFT: Display upshift recommendation in the display (ON) or not (OFF)
- BRIGHT: Set display brightness, from normal (0) to bright (5)
- with daytime riding lights^{OE}
- DLIGHT: Activate daytime riding light (ON) or deactivate the same (OFF)◀
- EXIT: Exit SETUP menu
- with on-board computer Pro^{OE}
- BC CUSTOM: Start individualisation of the display◀



- In order to exit the SETUP menu, at the menu item SETUP EXIT press and hold button **1**.
- In order to cancel the SETUP menu at any point, press button **2** and hold.

Setting clock

- In the SETUP menu, select the menu item SETUP CLOCK.



- Keep button **2** pressed until the hours in the bottom display line **3** start to flash.

▶ If "-- : --" is displayed instead of the time, the voltage supply of the instrument cluster has been interrupted (e.g. by disconnecting the battery).◀

- Press button **1** to increase the flashing value or button **2** to reduce the same.
- Keep button **2** pressed until the minutes in the bottom display line **3** start to flash.

- Press button **1** to increase the flashing value or button **2** to reduce the same.
- Keep button **2** pressed until the minutes no longer flash.
 - » Setting is complete.
- In order to cancel the setting at any point, keep button **1** pressed until the initial value is shown again.

▶ If you drive off before the setting has been completed, the setting will be cancelled.◀

Set date

- In the SETUP menu, select the menu item SETUP DATE.



- Keep button **2** pressed until the day in the bottom display line **3** starts to flash.

▶ If "-- . -- . --" is displayed instead of the date, the voltage supply of the instrument cluster has been interrupted (e.g. by disconnecting the battery).◀

- Press button **1** to increase the flashing value or button **2** to reduce the same.
- Keep button **2** pressed until the month in the bottom display line **3** starts to flash.

- Press button **1** to increase the flashing value or button **2** to reduce the same.
- Keep button **2** pressed until the year in the bottom display line **3** starts to flash.
- Press button **1** to increase the flashing value or button **2** to reduce the same.
- Keep button **2** pressed until the year no longer flashes.
- » Setting is complete.
- In order to cancel the setting at any point, keep button **1** pressed until the initial value is shown again.

▶ If you drive off before the setting has been completed, the setting will be cancelled.◀

Individualising display

– with on-board computer Pro^{OE}

In the individualisation menu it is possible to set which information is to be displayed in which display line.

- In the SETUP menu, select the menu item SETUP BC BASIC.



- Briefly press button **1** to start the individualisation menu.
- » SETUP BC CUSTOM appears on the display.
- Briefly press button **1** again to exit the individualisation menu.

▶ If SETUP BC BASIC is selected, then the factory setting will be active again. The individualisation CUSTOM remains stored.◀



- Press button **1** for a long period in order to display the first menu item.
- » SETUP BC ODO appears on the display.



- Respectively press button **1** briefly in order to go to the next menu item.
 - » The top display line **2** shows the menu item.
 - » The bottom display line **3** shows the preset value. The following values can be set.
 - TOP: The value is displayed in the top display line.
 - BELOW: The value is displayed in the bottom display line.
 - BOTH: The value is displayed in both display lines.

- OFF: The value is not displayed.
 - Press button **4** briefly in order to change the set value.
- The following menu items can be selected, the works setting is shown in brackets. Some menu items will only be selected if the relevant special equipment (OE) is actually present.
- ODO: Total mileage counter (TOP, the setting OFF is not possible)
 - TRIP 1: Tripmeter 1 (TOP)
 - TRIP 2: Tripmeter 2 (TOP)
 - TRIP A: Automatic tripmeter (TOP)
 - EXTEMP: Ambient temperature (BELOW)
 - ENGTMP: Engine temperature (BELOW)
 - RANGE: Range (TOP)
 - CONS R: Average consumption for range calculation (OFF)

- CONS 1: Average consumption 1 (BELOW)
- CONS 2: Average consumption 2 (BELOW)
- CONS C: Current consumption (TOP)
- ØSPEED: Average speed (BELOW)
- SPEED: Current speed (TOP)
- RDC: Tyre pressures (BELOW)
- VOLTGE: Vehicle circuit voltage (BELOW)
- ALTIME: Stopwatch total time (BELOW)
- RDTIME: Stopwatch driving time (BELOW)
- DATE: Date (BELOW)
- SERV T: Date of the next service (OFF)
- SERV D: Remaining mileage until the next service (OFF)
- OILLVL: Oil level note (BELOW)

- EXIT: Exit individualisation menu



- When the menu item **SETUP EXIT** displays, press and hold button **2** to exit the individualisation menu.
- In order to exit the individualisation menu at any point, press and hold button **1**.
- » All settings made until then will be saved.

Lights

Low-beam headlight and sidelights

The side lights switch on automatically when the ignition is switched on.

 The side lights place a strain on the battery. Do not switch the ignition on for longer than absolutely necessary.◀

The low-beam headlight switches on automatically when the engine is switched on.

- with daytime riding lights^{OE}
In daytime the daytime riding lights can be switched on as an alternative to the low-beam headlight.

High-beam headlight and headlight flasher

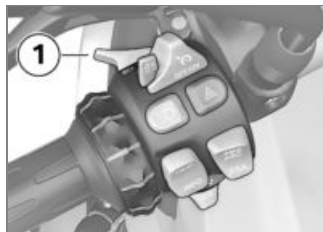

- Push switch **1** forward to switch on the high-beam headlight.
- Pull switch **1** back to operate the headlight flasher.

Parking light

- Switch off the ignition.

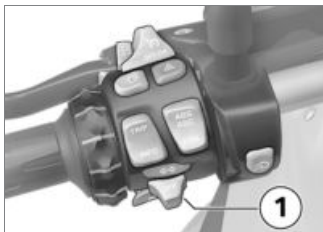

- Immediately after switching off the ignition, push button **1** to the left and hold it in this position until the parking lights come on.
- Switch the ignition on and off again to switch off the parking lights.

Auxiliary headlights

– with LED auxiliary headlight^{OA}

Precondition: The auxiliary headlights are only active, if the low-beam headlight is active; if the daytime riding light is switched

on, the auxiliary headlights cannot be switched on.



- Press button **1** to switch on the auxiliary headlights.
-  The indicator light for the auxiliary headlight illuminates.
- Press button **1** again to switch off the auxiliary headlights.

 The LED auxiliary headlights have an overheat cutout. The headlights automatically reduce their brightness if a certain temperature is reached; under extreme circumstances the headlights can even switch them-

selves off. The headlights return to full brightness once they have cooled down sufficiently.◀

Daytime riding lights

Manual daytime riding light

– with daytime riding lights^{OE}

Precondition: automatic daytime riding light is switched off.

 If the daytime riding light is switched on when it is dark, the vision deteriorates and oncoming traffic may be dazzled. Do not use the daytime riding light when it is dark.◀

 By comparison with the low-beam headlight, the daytime riding lights make the vehicle more visible to oncoming traffic. This improves daytime visibility.◀

- Start the engine.

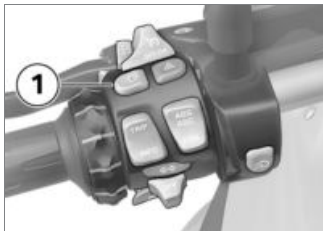

- Press button **1** to switch on the daytime riding lights.

 The indicator light for the daytime riding light illuminates.

- » The low-beam headlight, the front side lights and the auxiliary headlight are switched off.
- In the dark or in tunnels: Press button **1** again to switch off the daytime riding lights and switch on the low-beam headlight. The auxiliary headlight is also switched on again.

 If the high beam headlight is switched on whilst the daytime riding light is switched on, the daytime riding light will be switched off after approx. 2 seconds, and the high beam headlight, low beam headlight, front side lights and, if applicable, the auxiliary headlights will be switched on. If the high beam headlight is switched off again, the daytime riding light is not automatically reactivated, but must be switched on again if required.◀

Automatic daytime riding light

– with daytime riding lights^{OE}

 The changeover between daytime riding light and low beam headlight incl. front side lights can be effected automatically.◀

 The automatic riding light control system cannot replace your personal assessment of lighting conditions. The light sensor measurement may be falsified by e. g. fog or misty weather.

In such situations the low beam headlight must be switched on manually, as otherwise as safety risk would occur.◀

- In the SETUP menu of the display, at the menu item DLIGHT set the automatic daytime riding light to ON.

 The indicator light for the automatic daytime riding light illuminates.

- » If the ambient brightness decreases below a certain value, the low beam headlight is automatically switched on (e. B. in a tunnel). If a sufficient ambient brightness is detected, the daytime riding light is switched

on again. If the daytime riding light is active, the daytime riding light symbol is displayed in the multifunction display.

Manual operation of the light when the automatic system is switched on

- with daytime riding lights^{OE}
- If the button for the daytime riding light is pressed, the daytime riding light is switched off and the low beam headlight and front side lights will be activated (e. g. when driving into tunnels, where the automatic daytime riding light only responds with some delay due to the ambient brightness). If the daytime riding light is switched off the auxiliary headlight is switched on again.
- If the daytime riding light button is pressed again, the automatic daytime riding light is activated again, that is, the

daytime riding light will be switched on again once the required ambient brightness is switched on again.

Turn indicators

Operate the flashing turn indicators

- Switch on the ignition.

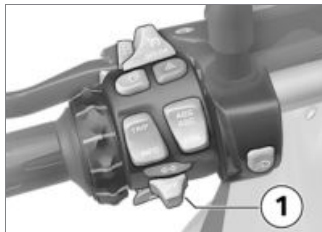

- Push button **1** to the left to switch on the left flashing turn indicators.
- Push button **1** to the right to switch on the right flashing turn indicators.

- Centre button **1** to cancel the flashing turn indicators.

 The turn indicators are cancelled automatically after you have ridden for approximately 10 seconds and covered a distance of about 300 m. ◀

Hazard warning flashers

Operating hazard warning flashers

- Switch on the ignition.

 The hazard warning flashers place a strain on the battery. Do not use the hazard warning flashers for longer than absolutely necessary. ◀

 If you press a turn-indicator button with the ignition switched on, the turn-indicator function is activated instead of the hazard warning flashers, and remains active until you release

the button. The hazard warning flashers recommence flashing as soon as the button is released.◀

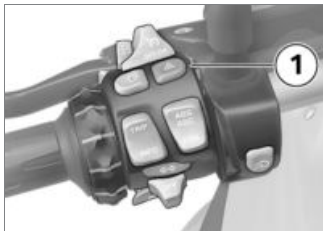

- Press button **1** to switch on the hazard warning flashers.
» Ignition can be switched off.
- Press button **1** again to switch off the hazard warning flashers.

Emergency off switch (kill switch)



- 1** Emergency off switch (kill switch)

 Operating the kill switch when riding can cause the rear wheel to lock and thus cause a fall.

Do not operate the kill switch when riding.◀

The emergency off switch is a kill switch for switching off the engine quickly and easily.

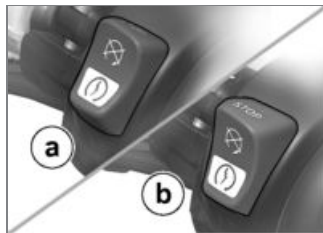

- a** Engine switched off
b Normal operating position (run)

Heated handlebar grips

– with heated handlebar grips^{OE}

Operate the heated handlebar grips

- Start the engine.

 Grip heating can be activated only when the engine is running.◀

 The increase in power consumption caused by the grip heating can drain the battery if you are riding at low engine speeds. If the charge level is low, grip heating is switched off to ensure the battery's starting capability. ◀



- Repeatedly press button **1** until the desired heating stage appears on the display.



The handlebar grips have two-stage heating. The preset level is shown in the multifunction display in position **1**.



50 % heating power



100 % heating power

- » The second heating stage is for heating the grips quickly: subsequently one should switch back to the first stage.
- » The selected heating stage will be saved if you allow a certain

length of time to pass without making further changes.

BMW Motorrad Integral ABS

Deactivating ABS function

- Bring the motorcycle to a stop or, if the motorcycle is at a standstill, switch on the ignition.

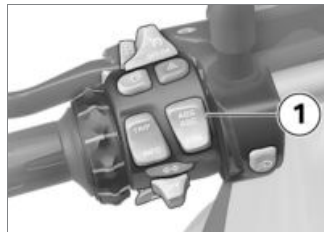

- Press and hold down button **1** until the ABS warning light changes status.

- with riding modes^{OE}
- » Initially, the ASC symbol changes status. Press and hold down button **1** until the ABS warning light responds. Under these circumstances there is no change in the ASC setting.<



The ABS warning light comes on.

- Release button **1** within two seconds.
-  The ABS warning light remains ON.
- » The ABS function is deactivated, but the integral function remains active.

Response with ABS deactivated

If you deactivate the ABS, the function is initially disabled for the front wheel only. If you subsequently apply the brakes by pulling only the handbrake lever,

the Integral function ensures that the rear wheel is also braked and ABS control remains active for the rear wheel. ABS control for the rear wheel is not deactivated until you depress the footbrake lever.

Activating ABS function

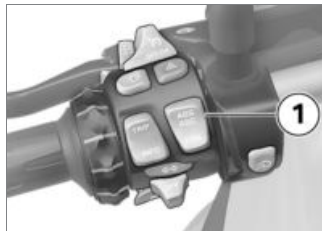

- Press and hold down button **1** until the ABS warning light changes status.
-  The ABS warning light goes out; if self-diagnosis has not completed it starts flashing.

- Release button **1** within two seconds.



The ABS warning light remains off or continues to flash.

- » The ABS function is activated.
- You also have the option of switching the ignition off and then on again.



An ABS fault has occurred if the ABS warning light shows when the motorcycle accelerates to a speed in excess of 5 km/h after the ignition was switched off and then on again.<

Automatic Stability Control ASC

– with riding modes^{OE}

Deactivating ASC function

- Switch on the ignition.

 You have the option of deactivating the ASC function while the motorcycle is on the move. ◀



- Press and hold down button **1** until the ASC warning light changes status.

 The ASC warning light illuminates.

- Release button **1** within two seconds.

 The ASC warning light continues to be illuminated.

- » The ASC function is deactivated.

Activating ASC function

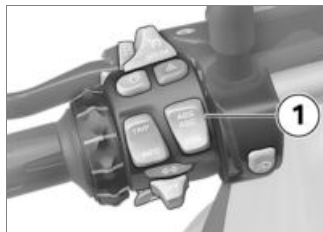

- Press and hold down button **1** until the ASC warning light changes status.

 ASC warning light goes out; if self-diagnosis has not completed the ASC warning light starts flashing.

- Release button **1** within two seconds.

 The ASC warning light still does not illuminate or continues to flash.

- » The ASC function is activated.

- You also have the option of switching the ignition off and then on again.

 An ASC fault has occurred if the ASC warning light shows when the motorcycle accelerates to a speed in excess of 5 km/h after the ignition was switched off and then on again. ◀

Riding mode

- with riding modes^{OE}

Riding mode

BMW Motorrad has developed five operational scenarios for your motorcycle from which you can select the scenario suitable for your situation:

- Riding on a rain-wet road surface.
- Riding on a dry road surface.
- Sporty riding on a dry road surface.
- Riding in easy off-road terrain.

– Sporty off-roading.

The interplay of engine torque, throttle response, ABS control and ASC control is optimised for each of these scenarios.

– with Dynamic ESA^{OE}

The chassis adjustment also adapts to the selected scenario.

Setting riding mode

 The off-road mode (Enduro and Enduro Pro) is not intended for normal on-road riding. Activating the off-road mode (Enduro and Enduro Pro) during on-road riding can result in unstable riding conditions when braking with ABS intervention or accelerating with ASC intervention. This could cause a fall.

Activate off-road mode (Enduro and Enduro Pro) only for off-road riding. ◀

- Switch on the ignition.



- Press button **1**.

 See the section entitled "Engineering details" for more information on the various ride modes that can be selected. ◀



The selection arrow **1** and the first selectable riding mode **2** are displayed.



- Press button **1** as often as necessary until the required riding

mode is indicated next to the selection arrow.

The following ride modes can be selected:

- RAIN: For riding on a rain-wet road surface.
- ROAD: For riding on a dry road surface.
- DYNA: For dynamic riding on a dry road surface.
- Enduro: For off-roading.
- Enduro PRO: For sporty off-road riding (with fitted coding plug only).
- When the Enduro PRO mode is selected: Note that ABS control for the rear wheel is restricted (see the section entitled "Engineering details").
 - » With the motorcycle at a standstill, the selected mode is activated after approximately two seconds.
 - » The newly selected riding mode is activated as you

ride only when the following preconditions are satisfied:

- Throttle twistgrip in idle position
- Clutch pulled
 - » Following activation of the new riding mode the clock is displayed again.
 - » The riding mode set, with the corresponding adaptations of engine characteristics, ABS, ASC and Dynamic ESA, is retained even after the ignition has been switched off.

Installing coding plug

- Switch off the ignition.
- Remove front seat (▶▶ 75).



Dirt and moisture can penetrate the open plug and lead to malfunctions. Reinstall the cap after removing the coding plug.◀

- Remove cap of plug 1.



- For this purpose press locking mechanism **1** and withdraw cap.
- Install the coding plug.
- Switch on the ignition.



The symbol **1** for the coding plug is shown in the display. The

riding mode **2** Enduro PRO is selectable.

- » The selected riding mode is retained in memory, even after the ignition is switched off.
- Installing front seat (→ 75).

Cruise-control system

– with speed control^{OE}

Switch on cruise control

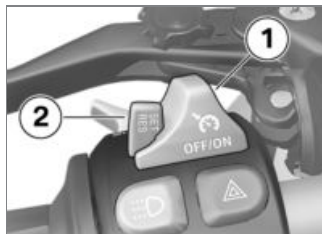

- Slide switch **1** to the right.
- » Button **2** is operational.

Saving road speed



- Briefly push button **1** forward.

 Adjustment range for speed control

– 30...210 km/h

 Telltale light for cruise control shows.

- » The motorcycle maintains your current cruising speed and the setting is saved.

Accelerate



- Briefly push button **1** forward.
 - » Speed is increased by approx. 2 km/h each time you push the button.
- Push button **1** forward and hold it in this position.
 - » The motorcycle accelerates steplessly.
 - » The current speed is maintained and saved if button **1** is not pushed again.

Decelerate



- Briefly push button **1** back.
 - » Speed is reduced by approx. 2 km/h each time you push the button.
- Push button **1** back and hold it in this position.
 - » The motorcycle decelerates steplessly.
 - » The current speed is maintained and saved if button **1** is not pushed again.

Deactivate cruise control

- Brake, pull the clutch lever or turn the throttle twistgrip (close the throttle by turning

the twistgrip back past the idle position) to deactivate the cruise-control system.

- » Telltale light for cruise-control goes out.

Resume former cruising speed

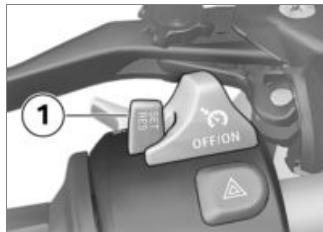

- Briefly push button **1** back to return to the speed saved beforehand.

 Opening the throttle does not deactivate the cruise-control system. If you release the twistgrip the motorcycle will decelerate only to the cruising

speed saved in memory, even though you might have intended slowing to a lower speed. ◀



Telltale light for cruise control shows.

Switching off cruise control



- Slide switch **1** to the left.
 - » The system is deactivated.
 - » Button **2** is disabled.

Clutch

Adjusting clutch lever



Attempting to adjust the clutch lever while riding the motorcycle can lead to accidents. Do not attempt to adjust the clutch lever unless the motorcycle is at a standstill. ◀

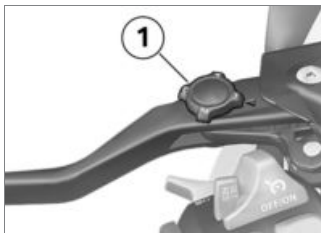

- Turn adjusting screw **1** to the desired position.



The adjusting screw is easier to turn if you push the clutch lever forward. ◀

- » Four settings are possible:

- Position 1: smallest span between handlebar grip and clutch lever
- Position 4: largest span between handlebar grip and clutch lever

Brakes

Adjust the front brake lever



Attempting to adjust the handbrake lever while riding the motorcycle can lead to accidents.

Do not attempt to adjust the handbrake lever unless the motorcycle is at a standstill. ◀

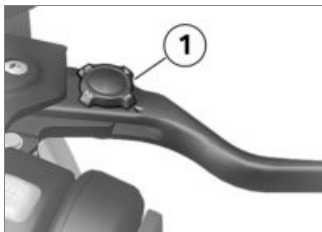

- Turn adjusting screw **1** to the desired position.

 The adjusting screw is easier to turn if you push the handbrake lever forward. ◀

- » Four settings are possible:
- Position 1: smallest span between handlebar grip and brake lever
 - Position 4: largest span between handlebar grip and brake lever

Mirrors

Adjusting mirrors



- Turn the mirror to the correct position.

Adjusting mirror arm

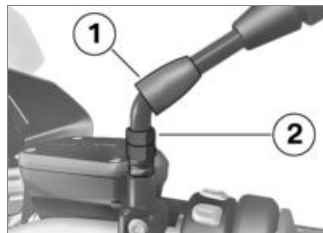

- Push protective cap **1** up over the threaded fastener on the mirror arm.
- Slacken nut **2**.
- Turn the mirror arm to the appropriate position.
- Tighten the nut to the specified tightening torque, while holding the mirror arm to ensure that it does not move out of position.



Mirror (lock nut) to adapter

– 22 Nm

- Push the protective cap over the threaded fastener.

Handlebars

Adjustable handlebars

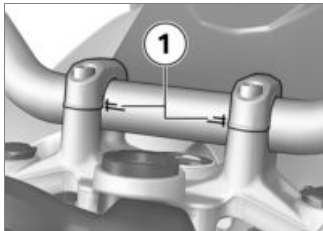

The motor cycle handlebars can be adjusted in their tilt within the ranges of marking **1**. If you want to have the handlebars adjusted consult a specialist workshop, preferably an authorised BMW Motorrad dealer.

Windscreen

Adjusting windscreen

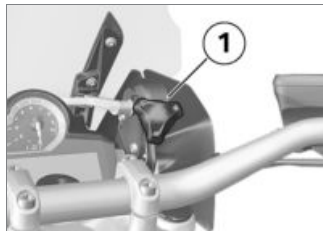

⚠ Risk of accident when adjusting the windscreen during the journey. Set windscreen only when stationary. ◀

- Turn adjustment wheel **1** clockwise to lower the windscreen.
- Turn adjustment wheel **1** counter-clockwise to raise the windscreen.

Spring preload

Setting

It is essential to set spring preload of the rear suspension to suit the load carried by the motorcycle. Increase spring preload when the vehicle is heavily loaded and reduce spring preload accordingly when the vehicle is lightly loaded.

Adjust spring preload for rear wheel

- Make sure the ground is level and firm and place the motorcycle on its stand.



! Your motorcycle's handling will suffer if you do not match the spring-preload and damping-characteristic settings. Adjust the damping characteristic to suit spring preload.◀

! Adjusting spring preload while the motorcycle is being ridden can lead to accidents. Do not attempt to adjust spring preload unless the motorcycle is at a standstill.◀

- If you want to reduce spring preload, turn knob **1** in the direction indicated by the LOW arrow.

- If you want to increase spring preload, turn knob **1** in the direction indicated by the HIGH arrow.



Basic setting of spring preload, rear

- without Dynamic ESA^{OE}
- Turn adjuster knob in direction LOW until the stop position is reached (Full load of fuel, with rider 95 kg)◀

Damping Setting

Damping must be adapted to suit the surface on which the motorcycle is ridden and to suit spring preload.

- An uneven surface requires softer damping than a smooth surface.
- An increase in spring preload requires firmer damping, a re-

duction in spring preload requires softer damping.

Adjusting the damping for rear wheel

- Make sure the ground is level and firm and place the motorcycle on its stand.
- Set the damping from the left-hand vehicle side.

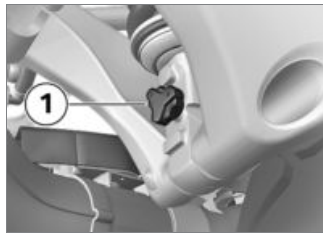

- Turn setting screw **1** in clockwise direction to increase the damping.
- Turn setting screw **1** in anti-clockwise direction to decrease damping.



Basic setting of rear-suspension damping characteristic

– without Dynamic ESA^{OE}

– Turn adjuster screw clockwise until the stop position is reached, then turn 8 clicks in a counter-clockwise direction (Full load of fuel, with rider 95 kg)<1

Dynamic ESA, electronic suspension adjustment

– with Dynamic ESA^{OE}

Settings

Using the electronic chassis adjustment Dynamic ESA you can comfortably adapt your motorcycle to the actual vehicle load. Via ride height sensors Dynamic ESA detects the movements in the chassis and suspension, and

responds to the same by adjusting the damper valves. The chassis and suspension will thus be adapted to the characteristics of the terrain.

Starting from the basic setting NORMAL the damping can be made harder (HARD) or softer (SOFT).

– with riding modes^{OE}

The setting of the chassis and suspension and the number of the selectable damping variants depend on the riding mode selected. The damping specified by the riding mode can be changed by the driver.

If the coding plug is not fitted, the basic setting specified by the riding mode will be set after each mode change. If the coding plug is fitted, the driver's adjustments are retained for all modes.

Viewing suspension settings

- Switch on the ignition.

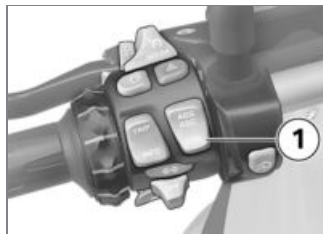

- Press button **1** briefly to view the current setting.



In the multifunction display the damping is shown in area **1**, the spring preload in area **2**.

» The setting shows briefly, then disappears automatically.

Adjusting suspension

- Switch on the ignition.

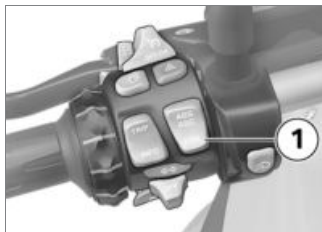

- Press button **1** briefly to view the current setting.

To adjust damping:

- Repeatedly press button **1** until the setting you want to use appears on the display.

 You can adjust the damping characteristic while the motorcycle is on the move.◀

The following settings are available:

- SOFT: Comfortable damping characteristic
- NORMAL: Normal damping characteristic

– HARD: Sporty damping characteristic

– with riding modes^{OE}

In the modes ENDURO and ENDURO PRO only two settings are possible:

- SOFT: Comfortable damping characteristic
- HARD: Sporty damping characteristic

To adjust spring preload:

- Start the engine:

 You cannot adjust spring preload while the motorcycle is on the move.◀

- Repeatedly press button **1** and hold until the setting you want to use appears on the display.

The following settings are available:

 One-up

If an alarm was triggered while the motorcycle was unattended, the rider is notified accordingly by an alarm tone sounding once when the ignition is switched on. The anti-theft alarm telltale light then signals the reason for the alarm for one minute.

The meanings of the flash codes are as follows:

- Flashes 1x: Motion sensor 1
- Flashes 2x: Motion sensor 2
- Flashes 3x: Ignition switched on with unauthorized key
- Flashes 4x: Disconnect of the anti-theft alarm from the motorcycle's battery
- Flashes 5x: Motion sensor 3

Deactivation

- Kill switch in operating position (run).
- Switch on the ignition.
 - » Turn indicators flash once.

- » Confirmation tone sounds once (if programmed).
- » Anti-theft alarm is deactivated.

Customising anti-theft alarm settings

- Switch on the ignition, or bring the motorcycle to a stop.



- Repeatedly press button **1** briefly until the top display line displays **2** SETUP ENTER.
- Press and hold button **1** to start the SETUP menu.



- Respectively press button **1** briefly to go to the next menu item DWA.
 - » In the top display line **2** DWA is indicated.
 - » The bottom display line **3** shows the preset value.
- Press button **4** briefly in order to change the set value.

The following settings are available:

- On: The alarm system has been activated or will be activated automatically when the ignition is switched.

- Off: Alarm system is deactivated.

Tyres

Checking tyre pressure



Incorrect tyre pressures impair the motorcycle's handling characteristics and increase the rate of tyre wear.

Always check that the tyre pressures are correct. ◀





At high road speeds, tyre valves installed perpendicular to the wheel rim have a tendency to open as a result of centrifugal force.

In order to avoid a sudden loss of tyre pressure, fit a valve cap with rubber sealing ring to the rear tyre and make sure that the cap is screwed on firmly. ◀

- Make sure the ground is level and firm and place the motorcycle on its stand.

- Check tyre pressures against the data below.

 Tyre pressure, front
– 2.5 bar (Tyre cold)
 Tyre pressure, rear
– 2.9 bar (Tyre cold)

If tyre pressure is too low:

- Correct tyre pressure.

Headlight

Adjusting headlight for driving on left/driving on right

This motorcycle has a symmetric-beam low-beam headlight. If the motorcycle is ridden in a country where the opposite rule of the road applies, its symmetric low-beam headlight means that

no measures are necessary to prevent the headlight beam from dazzling oncoming traffic.

Headlight beam throw and spring preload

Headlight beam throw is generally kept constant when spring preload is adjusted to suit load. Spring preload adjustment might not suffice only if the motorcycle is very heavily loaded. Under these circumstances, headlight beam throw has to be adjusted to suit the weight carried by the motorcycle.



If there are doubts about the correct headlight range, seek the advice of a specialist workshop, preferably an authorised BMW Motorrad dealer. ◀

Adjust headlight beam throw



If, for a high load, the adjustment of the spring pre-load is no longer sufficient not to dazzle oncoming traffic:

- Turn adjuster knob **1** in a counter-clockwise direction in order to lower the headlight beam again.

When the motorcycle is again ridden with a lower load:

- Have the basic settings of the headlight restored by a specialist workshop, best of all by a BMW Motorrad dealer.

– with LED headlights^{OE}



Beam throw can also be adjusted by means of a pivot lever instead of the adjuster knob.

- To shorten beam throw for riding with the motorcycle heavily loaded, set pivot lever **1** to the horizontal position.

When the motorcycle is again ridden with a lower load:

- Turn pivot lever **1** to the vertical position.<

Front and rear seats

Removing rear seat

- Make sure the ground is level and firm and place the motorcycle on its stand.



- Turn the key clockwise in seat lock **1** and hold it in this position while pressing down the rear part of rear seat **2**.
- Lift the rear seat at the front and release the key.
- Remove the rear seat and place it, upholstered side down, on a clean surface.

Installing rear seat

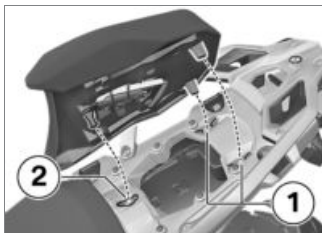

- Place the rear seat centrally into the rear mountings **1** and into the front mounting **2**.
- In order to position the rear seat closer to the rider's seat, press rear seat evenly forwards and downwards over the mountings until the locking mechanism engages.
- In order to position the rear seat further away from the rider's seat, press rear seat evenly backwards and downwards over the mountings un-

til the locking mechanism engages.

Removing front seat

- Removing rear seat (▣▣▣ 74).

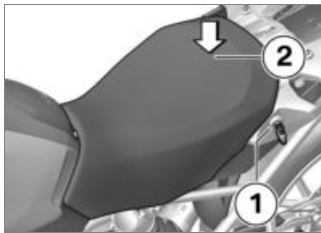

- Use vehicle key to turn seat lock **1** to the left and hold, supportingly press down the rider's seat in the rear area **2**.
- Lift the front seat at the rear and release the key.
- Remove the front seat and place it, upholstered side down, on a clean surface.

Installing front seat

- Removing rear seat (▣▣▣ 74).
- Adjusting seat height and seat tilt (▣▣▣ 75).

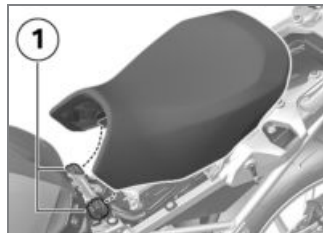

- Set rider's seat into the mountings **1** left and right, and place loosely on the motorcycle.
- Press the rider's seat slightly forward in its rear area and then firmly down until the locking mechanism engages.

Adjusting seat height and seat tilt

- Remove front seat (▣▣▣ 75).

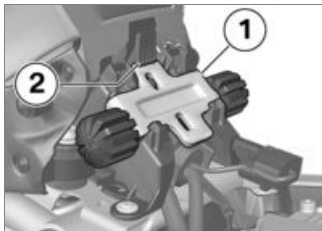

- In order to remove the front height adjustment **1**, press down locking mechanism **2** and remove height adjustment in an upward direction.

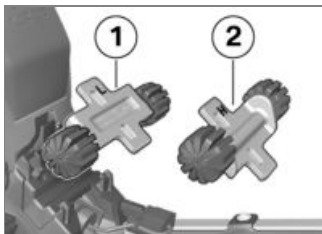

- In order to set the low seat position, install front height ad-

justment in the alignment **1** (identification L).

- In order to set the high seat position, install front height adjustment in the direction **2** (identification H).

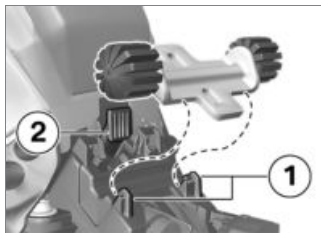

- Initially push front height adjustment under the mountings **1**, subsequently press into the locking mechanism **2** until the same engages.

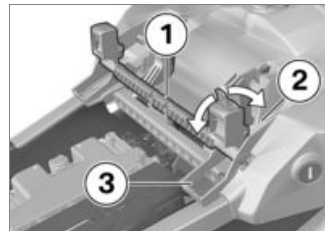

- In order to set the low seat position, swivel rear height adjustment **1** into position **3** (identification L).
- In order to set the high seat position, swivel rear height adjustment **1** into position **2** (identification H).

If the seat tilt is to be changed:

- Position front and rear height adjustment differently.

Riding

Safety instructions	78
Checklist.....	80
Starting	81
Running in	83
Off-roading	84
Brakes	85
Parking your motorcycle	86
Refuel	86
Fuel grade	88
Secure motorcycle for transportation	88

Safety instructions

Rider's equipment

Do not ride without the correct clothing. Always wear:

- Helmet
- Motorcycling jacket and trousers
- Gloves
- Boots

This applies even to short journeys, and to every season of the year. Your authorised BMW Motorrad dealer will be glad to advise you on the correct clothing for every purpose.

Restricted angle of heel

- with lowered suspension^{OE}

A motorcycle with lowered suspension has less ground clearance and cannot corner at angles of heel as extreme as those achievable by a

counterpart motorcycle with standard-height suspension.



Risk of accident by unexpectedly early contact with the ground.

Bear in mind that lowered suspension limits the motorcycle's angle of heel and ground clearance.◀

Test your motorcycle's angle of heel in situations that do not involve risk. When riding over kerbs and similar obstacles, bear in mind that your motorcycle's ground clearance is limited.

Lowering the motorcycle's suspension shortens suspension travel (see the section entitled "Technical Data"). Ride comfort might be restricted as a result. Be sure to adjust spring preload accordingly, particularly for riding two-up.

Loading



Overloading and imbalanced loads can adversely affect the motorcycle's handling. Do not exceed the permissible gross weight and be sure to comply with the instructions on loading.◀

- Adjusting spring preload setting and damping to the total weight.
- with cases^{OA}
- Ensure that the case volumes on the left and right are equal.
- Make sure that the weight is uniformly distributed between right and left.
- Pack heavy items at the bottom and toward the inboard side.
- Note the maximum permissible payload and the speed limit for riding with cases fitted, as

stated on the label inside the case.<

– with topcase^{OA}

- Note the maximum permissible payload and the speed limit for riding with topcase fitted, as stated on the label inside the topcase.<

– with tank rucksack^{OA}

- Note the maximum permissible payload of the tank rucksack and the speed limit for riding with a tank rucksack on the motorcycle.



Payload of tank bag

– max 5 kg<

Speed

If you ride at high speed, always bear in mind that various boundary conditions can adversely af-

fect the handling of your motorcycle:

- Settings of the spring-strut and shock-absorber system
- Imbalanced load
- Loose clothing
- Insufficient tyre pressure
- Poor tyre tread
- Etc.

Maximum speed with massive-bar tyres



The motorcycle's top speed might be higher than the maximum speed permitted for the tyres. Excessive speeds can damage the tyres and this could cause accidents.

Comply with the tyre-specific speed restrictions.<

Always bear the maximum permissible top speed of the tyres in mind when riding a motorcycle fitted with massive-bar tyres.

Affix a label stating the maximum permissible speed in the rider's field of vision.

Risk of poisoning

Exhaust fumes contain carbon monoxide, which is colourless and odourless but highly toxic.



Inhaling the exhaust fumes therefore represents a health hazard and can even cause loss of consciousness with fatal consequences.

Do not inhale exhaust fumes. Do not run the engine in an enclosed space.<

Risk of burn injury



Engine and exhaust system become very hot when the vehicle is in use. There is a risk of burn injuries by contact with hot surfaces.

When you park the motorcycle make sure that no-one comes

into contact with the engine and exhaust system. ◀

Catalytic converter

If misfiring causes unburned fuel to enter the catalytic converter, there is a danger of overheating and damage.

For this reason, observe the following points:

- Do not run the fuel tank dry
- Do not attempt to start or run the engine with a spark-plug cap disconnected
- Stop the engine immediately if it misfires
- Use only unleaded fuel
- Comply with all specified maintenance intervals.

 Unburned fuel will destroy the catalytic converter. Note the points listed for protection of the catalytic converter. ◀

Risk of overheating

 Cooling would be inadequate if the engine were allowed to idle for a lengthy period with the motorcycle at a standstill: overheating would result. In extreme cases, the motorcycle could catch fire. Do not allow the engine to idle unnecessarily. Ride away immediately after starting the engine. ◀

Tampering

 Tampering with motorcycle settings (e.g. electronic engine management unit, throttle valves, clutch) can cause damages to the components in question and lead to failure of safety-relevant functions. Damage caused in this way is not covered by the warranty. Do not tamper with the motorcycle in any way that could result in tuned performance. ◀

Checklist

Use the following checklist to check important functions, settings and wear limits before you ride off

- Brakes
- Brake-fluid levels, front and rear
- Cooling fluid level
- Clutch
- Damping-characteristic setting and spring preload
- Tyre-tread depth and tyre pressures
- Cases correctly installed and luggage secured

At regular intervals:

- Engine oil level (every refuelling stop)
- Brake-pad wear (every third refuelling stop)

Starting

Starting engine

- Switch on the ignition.
 - » Pre-ride check is performed. (►► 81)
 - » ABS self-diagnosis is performed. (►► 82)
 - with riding modes^{OE}
 - » ASC self-diagnosis is performed. (►► 82)◀
- Select neutral or, if a gear is engaged, pull the clutch lever.
 - ▶ You cannot start the motorcycle with the side stand extended and a gear engaged. The engine will switch itself off if you start it with the gearbox in neutral and then engage a gear before retracting the side stand.◀
- For a cold engine start and low temperatures: pull clutch.



- Press starter button **1**.

▶ The start attempt is automatically interrupted if battery voltage is too low. Recharge the battery before you start the engine, or use jump leads and a donor battery to start.◀

- » The engine starts.
- » Consult the troubleshooting chart below if the engine refuses to start. (►► 148)

Pre-ride check

When the ignition is switched on the instrument cluster carries out a test of the pointer instruments, warning lights and multifunction display, the "Pre-Ride-Check". The test is aborted if you start the engine before it completes.

- » Phase 1:
 - All warning and indicator lights are switched on.
 - The multifunction display shows all segments.
 - The "General" warning light shows red.
- » Phase 2:
 - The general warning light changes from red to yellow.
- » Phase 3:
 - The multifunction display and the warning and indicator lights change over to the regular display.

If symbols should not be shown and warning lights not displayed:



Some malfunctions cannot be indicated if one of the warning lights fails to show. Make sure that all the warning and telltale lights come on in the pre-ride check. ◀

- Have the fault rectified as quickly as possible by a specialist workshop, preferably an authorised BMW Motorrad dealer.

ABS self-diagnosis

BMW Motorrad Integral ABS performs self-diagnosis to ensure its operability. Self-diagnosis starts automatically when you switch on the ignition.

Phase 1

- » Test of the diagnosis-compatible system components with the vehicle at a standstill.



The ABS warning light flashes.

Phase 2

- » Test of the wheel sensors as the vehicle pulls away from rest. The motorcycle must reach a speed of at least 5 km/h in order for ABS self-diagnosis to complete.



The ABS warning light flashes.

ABS self-diagnosis completed

- » The ABS warning light goes out.

If an indicator showing an ABS fault appears when ABS self-diagnosis completes:

- You can continue to ride. Bear in mind that neither the ABS function nor the integral braking function is available.

- Have the fault rectified as quickly as possible by a specialist workshop, preferably an authorised BMW Motorrad dealer.

ASC self-diagnosis

– with riding modes^{OE}

BMW Motorrad ASC performs self-diagnosis to ensure its operability. Self-diagnosis starts automatically when you switch on the ignition.

Phase 1

- » Test of the diagnosis-compatible system components with the vehicle at a standstill.



The ASC warning light flashes slowly.

Phase 2

- » Test of the diagnosis-compatible system components while the motorcycle is on the move. The motorcycle must reach a

speed of at least 5 km/h with the engine running in order for ASC self-diagnosis to complete.



The ASC warning light flashes slowly.

ASC self-diagnosis completed

» The ASC symbol no longer shows.

If an indicator showing an ASC fault appears when ASC self-diagnosis completes:

- You can continue to ride. Bear in mind that the ASC function is not available.
- Have the fault rectified as quickly as possible by a specialist workshop, preferably an authorised BMW Motorrad dealer.

Running in Engine

- Until the running-in check, vary the throttle opening and engine-speed range frequently; avoid riding at constant engine rpm for prolonged periods.
- Try to do most of your riding during this initial period on twisting, fairly hilly roads.
- Comply with the rpm limits for running in.

 Running-in speeds
– <5000 min ⁻¹

- Note the mileage after which the running-in check should be carried out.

 Mileage until the running-in check
– 500...1200 km

Brake pads

New brake pads have to bed down before they can achieve their optimum friction levels. You can compensate for this initial reduction in braking efficiency by exerting greater pressure on the levers.



New brake pads can extend stopping distance by a significant margin. Apply the brakes in good time. ◀

Tyres

New tyres have a smooth surface. This must be roughened by riding in a restrained manner at various heel angles until the tyres are run in. This running in procedure is essential if the tyres are to achieve maximum grip.



New tyres do not provide full grip straight away. Wet roads and extremely sharp inclines pose a risk of accident.

Ride carefully and avoid extremely sharp inclines. ◀

Off-roading

For off-roading

Rims

 This motorcycle is a touring Enduro machine, which means it can also be used for light off-roading on unsurfaced tracks. Severe off-roading could, however, result in damage to the standard cast-aluminium wheels. Use the cross-spoked wheels available as optional extras for severe off-roading. ◀

After off-roading

BMW Motorrad recommends checking the following after riding the motorcycle off-road:

Tyre pressure

 Tyre pressures reduced for off-road riding impair the motorcycle's handling characteristics on surfaced roads and can lead to accidents. Always check that the tyre pressures are correct. ◀

Brakes

 When riding on loose surfaces or muddy roads, the brakes may fail to take effect immediately because of dirt or moisture on the discs or brake pads. Apply the brakes in good time until the brakes have been cleaned. ◀

 The brake pads will wear more rapidly if you ride frequently on unsurfaced tracks or poor roads. Check the thickness of the brake

pads more frequently and replace the brake pads in good time. ◀

Spring preload and shock-absorber settings

 The off-road settings for spring preload and shock absorber damping characteristic will impair the motorcycle's handling characteristics on surfaced roads.

If you have been off-roading, remember to correct spring preload and shock-absorber damping characteristics before you return to surfaced roads. ◀

Rims

BMW Motorrad recommends checking the rims for damage after off-roading.

Air filter element

 Engine damage due to clogged air filter element. If you ride in dusty terrain check

the air filter element for clogging at shorter intervals; clean or replace as necessary. ◀

Operation in very dusty conditions (desert, steppes, or the like) necessitates the use of air filter elements specially designed for conditions of this nature.

Brakes

How can stopping distance be minimised?

Each time the brakes are applied, a load distribution shift takes place with the load shifting forward from the rear to the front wheel. The sharper the motorcycle decelerates, the more load is shifted to the front wheel. The higher the wheel load, the more braking force can be transmitted without the wheel locking.

To optimise stopping distance, apply the front brakes rapidly and keep on increasing the force you

apply to the brake lever. This makes the best possible use of the dynamic increase in load at the front wheel. Remember to pull the clutch at the same time. In the "panic braking situations" that are trained so frequently braking force is applied as rapidly as possible and with the rider's full force applied to the brake levers; under these circumstances the dynamic shift in load distribution cannot keep pace with the increase in deceleration and the tyres cannot transmit the full braking force to the surface of the road.

BMW Motorrad Integral ABS prevents the front wheel from locking up.

Descending mountain passes



There is a danger of the brakes fading if you use only the rear brakes when descending mountain passes. Under extreme conditions, the brakes could overheat and suffer severe damage.

Use both front and rear brakes, and make use of the engine's braking effect as well. ◀

Wet and dirty brakes

Wetness and dirt on the brake discs and the brake pads diminish braking efficiency.

Delayed braking action or poor braking efficiency must be reckoned with in the following situations:

- Riding in the rain or through puddles of water.
- After the vehicle has been washed.

- Riding on salted or gritted roads.
- After work has been carried on the brakes, due to traces of oil or grease.
- Riding on dirt-covered surfaces or off-road.

 Wetness and dirt result in poor braking efficiency. Apply the brakes lightly while riding to remove wetness and dirt, or dismount and clean the brakes.

Think ahead and brake in good time until full braking efficiency is restored.◀

Parking your motorcycle

Side stand

- Switch off the engine.

 If the ground is soft or uneven, there is no guaran-

tee that the motorcycle will rest firmly on the stand.

Always check that the ground under the stand is level and firm.◀

- Extend the side stand and prop the motorcycle on the stand.

 The side stand is designed to support only the weight of the motorcycle.

Do not lean or sit on the motorcycle with the side stand extended.◀

- If the camber of the roadway permits, turn the handlebars all the way to the left.
- On a gradient, the motorcycle should always face uphill; select 1st gear.

Centre stand

- Switch off the engine.

 If the ground is soft or uneven, there is no guarantee that the motorcycle will rest firmly on the stand.

Always check that the ground under the stand is level and firm.◀

 Excessive movements could cause the centre stand to retract, and the motorcycle would topple in consequence.

Do not lean or sit on the motorcycle with the centre stand extended.◀

- Extend the centre stand and lift the motorcycle onto the stand.

Refuel

 Fuel is highly flammable. A naked flame close to the fuel tank can cause a fire or explosion.

Do not smoke. Never bring a naked flame near the fuel tank.◀

 Fuel expands when hot. Fuel escaping from an overfilled tank could make its way onto the road surface. This could cause a fall.

Do not overfill the fuel tank.◀

 Fuel attacks plastics, which become dull or unsightly. Wipe plastic parts immediately after contact with fuel.◀

- Make sure the ground is level and firm and place the motorcycle on its side stand.

 The volume of the tank can be utilised to the full only when the motorcycle is propped on its side stand.◀

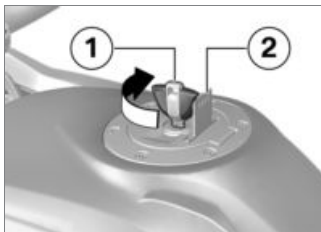



- Open the protective cap **2**.
- Use ignition key **1** to unlock fuel filler cap by turning it clockwise, and flip the cap open.



- Refuel with fuel of the grade stated below; do not fill the

tank past the bottom edge of the filler neck.

 If filling occurs after the fuel level has gone below the reserve limit, the amount filled must be greater than the reserve amount for the new fuel level to be recognised and the warning light to switch off.◀

 The "usable fuel capacity" specified in the technical data is the quantity that the fuel tank could hold if it had been run dry and the engine had cut out due to a lack of fuel.◀

 Usable fuel capacity

– approx. 20 l

 Reserve fuel

– approx. 4 l

- Press the fuel tank cap down firmly to close.
- Remove the key and close the protective cap.

Fuel grade

For optimum fuel consumption, fuel should be sulphur-free or as low-sulphur as possible.

 Leaded fuel will destroy the catalytic converter.

Do not fuel leaded fuel or fuel with metallic additives, e.g. manganese or iron. ◀

- Fuels with a maximum Ethanol content of 10 %, i.e. E10, can be fuelled.



Recommended fuel grade

- Super unleaded (max. 10 % ethanol, E10)
- 95 ROZ/RON
- 89 AKI



Alternative fuel grade

- Regular unleaded (Power- and consumption-related restrictions. If e.g. the engine is to be operated in countries with low fuel grades at 91 research octane number, then the motorcycle must first be programmed appropriately at your authorised BMW motorcycle dealer.)
- 91 ROZ/RON
- 87 AKI

Secure motorcycle for transportation

- Make sure that all components that might come into contact with straps used to secure the vehicle are adequately protected against scratching. Use adhesive tape or soft cloths, for example, for this purpose.



The motorcycle can topple and fall on its side.

Secure motorcycle against toppling; this is best done with the support of a 2nd person. ◀

- Push the motorcycle onto the transportation flat and hold it in position: do not place it on the side stand or centre stand.

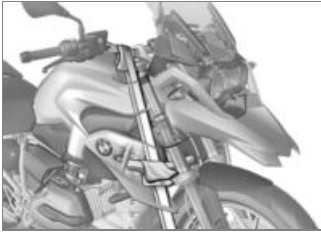

Risk of damaging components.

Take care not to trap components such as brake lines or wires. ◀

- At the front, secure the straps to the handlebars on both sides.
- Pass the straps through the leading link and tighten the straps.



- At the rear, secure the straps to the rear footrests on both sides and tighten the straps.
- Tighten all the straps uniformly; the vehicle's suspension should be compressed as tightly as possible front and rear.

Engineering details

Riding mode	92
Brake system with BMW Motorrad Integral ABS	93
Electronic engine management with BMW Motorrad ASC.....	96
Tyre pressure monitoring RDC	98

Riding mode

- with riding modes^{OE}

Selection

Five ride modes enable the motorcycle's characteristics to adapt to the prevailing weather conditions, the road and traffic, and the rider's style of riding:

- RAIN
- ROAD (Standard mode)
- DYNAMIC
- Enduro
- Enduro PRO (only if coding plug fitted)

For each of the five riding modes, there exists a matching setting for the systems ABS, ASC as well as for throttle response.

- with Dynamic ESA^{OE}

The adjustment of the Dynamic ESA also depends on the riding mode selected.

ABS and/or ASC can be switched off in each mode: the explanations below invariably apply to the behaviour of the motorcycle with these systems active.

Throttle response

- In the modes RAIN and ENDURO: Restrained.
- In the modes ROAD and ENDURO PRO: Direct.
- In the mode DYNAMIC: Dynamic.

ABS

- The rear wheel lift assistant is active in all modes.
- In the modes RAIN, ROAD and DYNAMIC the ABS is adjusted to road operation.

- In the mode ENDURO the ABS is adjusted to off-road operation using road tyres.
- In the mode ENDURO PRO there will be no ABS control at the rear wheel when the foot-brake lever is operated. The ABS has been adjusted to off-road operation using studded tyres.

ASC

- The front wheel lift assistant is active in all modes.
- In the RAIN, ROAD and DYNAMIC modes the ASC is set up for road riding.
- In the ENDURO and ENDURO PRO modes the ASC is set up for off-road riding.

- with Dynamic ESA^{OE}

Dynamic ESA

- In the modes RAIN, ROAD and DYNAMIC the damping

variants HARD, NORMAL and SOFT can be selected.

- Basic setting RAIN: SOFT.
- Basic setting ROAD: NORMAL.
- Basic setting DYNAMIC: HARD.
- In the modes ENDURO and ENDURO PRO the damping variants HARD and SOFT can be selected.
- Basic setting ENDURO: SOFT.
- Basic setting ENDURO PRO: HARD.

Mode changes

Function changeover in engine management and the ABS and ASC systems is possible only in certain operating states when the motorcycle is being ridden:

- No drive torque at the rear wheel
- No brake pressure in the brake system

In order to achieve this state:

- The motorcycle must be at a standstill with the ignition switched on,

or

- The throttle twistgrip must be in the fully closed position,
- The brake levers must be in the released positions,
- The clutch lever must be pulled and the clutch disengaged.

The desired riding mode is initially preselected. The mode change does not take place until the systems in question are all in the appropriate state.

The selection menu does not disappear from the display until the mode change has taken place.

Brake system with BMW Motorrad Integral ABS

Partially integral brakes

Your motorcycle is equipped with partially integral brakes. Both front and rear brakes are applied when you pull the handbrake lever. The footbrake lever acts only on the rear brake.

While the brakes are slowing the motorcycle with ABS actively intervening, the BMW Motorrad Integral ABS adapts braking-force distribution between front and rear brakes to suit the load on the motorcycle.



Due to the integral function a spinning of the rear wheel with operated front wheel brake (Burn Out) is not possible. Attempted burn-outs can result in damage to the rear brake and the clutch.

Do not attempt burn-outs.◀

How does ABS work?

The amount of braking force that can be transferred to the road depends on factors that include the coefficient of friction of the road surface. Loose stones, ice and snow or a wet road all have much lower coefficients of friction than a clean and dry asphalt surface. The lower the coefficient of friction, the longer the braking distance.

If the rider increases braking pressure to the extent that braking force exceeds the maximum transferable limit, the wheels start to lock and the vehicle loses its directional stability; a fall is imminent. Before this situation occurs the ABS will be activated and the brake pressure adapted to the maximally transferable braking force. The wheels continue to turn and the driving stability is retained irrespective of the road condition.

What are the effects of surface irregularities?

Humps and surface irregularities can cause the wheels to lose contact temporarily with the road surface; if this happens the braking force that can be transmitted to the road can drop to zero. If the brakes are applied under these circumstances the ABS has to reduce braking force to ensure that directional stability is maintained when the wheels regain contact with the road surface. At this instant the BMW Motorrad Integral ABS must assume an extremely low coefficient of friction, so that the wheels will continue to rotate under all imaginable circumstances, because this is the precondition for ensuring directional stability. As soon as it registers the actual circumstances, the system reacts instantly and adjusts brak-

ing force accordingly to achieve optimum braking.

What feedback does the rider receive from the BMW Motorrad Integral ABS?

If the ABS system has to reduce braking force on account of the circumstances described above, vibration is perceptible through the handbrake lever.

When the handbrake lever is pulled, brake pressure is also built up at the rear wheel by the integral function. If the brake pedal is depressed after the handbrake lever is pulled, the brake pressure built up beforehand is perceptible as counter-pressure sooner than is the case when the brake pedal is depressed either before or at the same time as the brake lever is pulled.

Rear wheel lift

Under very severe and sudden deceleration, however, under certain circumstances it is possible that the BMW Motorrad Integral ABS will be unable to prevent the rear wheel from lifting clear of the ground. If this happens the outcome can be a highsiding situation in which the motorcycle can flip over.



Severe braking can cause the rear wheel to lift off the ground.

When you brake, bear in mind that ABS control cannot always be relied on to prevent the rear wheel from lifting clear of the ground. ◀

What is the design baseline for BMW Motorrad Integral ABS?

Within the limits imposed by physics, the BMW Motorrad Integral ABS ensures directional stability on any surface. The system is not optimised for special requirements that apply under extreme competitive situations off-road or on the track. The driving behaviour should be adapted to actual driving skills and the road conditions.

Special situations

The speeds of the front and rear wheels are compared as one means of detecting a wheel's incipient tendency to lock. If the system registers implausible values for a lengthy period the ABS function is deactivated for safety reasons and an ABS fault message is issued. Self-dia-

gnosis has to complete before fault messages can be issued. In addition to problems with the BMW Motorrad Integral ABS, exceptional riding conditions can lead to a fault message being issued.

Exceptional riding conditions:

- Heating up with the motorcycle on the centre stand or an auxiliary stand, engine idling or with a gear engaged.
- Rear wheel locked by the engine brake for a lengthy period, for example while descending on a loose or slippery surface.

If a fault message is issued on account of exceptional riding conditions as outlined above, you can reactivate the ABS function by switching the ignition off and on again.

What significance devolves on regular maintenance?



Invariably, a technical system cannot perform beyond the abilities dictated by its level of maintenance.

In order to ensure that the BMW Motorrad Integral ABS is always maintained in optimum condition, it is essential for you to comply strictly with the specified inspection intervals. ◀

Reserves for safety

The potentially shorter braking distances which BMW Motorrad Integral ABS permits must not be used as an excuse for careless riding. ABS is primarily a means of ensuring a safety margin in genuine emergencies.

Take care when cornering! When you apply the brakes on a corner, the motorcycle's weight and

momentum take over and even BMW Motorrad Integral ABS is unable to counteract their effects.

Electronic engine management with BMW Motorrad ASC

– with riding modes^{OE}

How does ASC work?

BMW Motorrad ASC compares the speed of rotation of the front wheel and the rear wheel. The differential is used to compute slip as a measure of the reserves of stability available at the rear wheel. If slip exceeds a certain limit the engine control intervenes, adapting engine torque accordingly.

What is the design baseline for BMW Motorrad ASC?

BMW Motorrad ASC is designed as an assistant system for the rider and for use on public roads. The extent to which the rider affects ASC control can be considerable (weight shifts when cornering, items of luggage loose on the motorcycle), especially when style of riding takes rider and machine close to the limits imposed by physics.

For off-road driving the riding mode ENDURO should be activated: This mode delays ASC intervention slightly in order to permit controlled drifting. The system is not optimised for special requirements that apply under extreme competitive situations off-road or on the track. BMW Motorrad ASC can be deactivated in these cases.



Even ASC is constrained by the laws of physics. Invariably, the rider bears responsibility for assessing road and traffic conditions and adopting his or her style of riding accordingly. Do not take risks that would negate the additional safety offered by this system.◀

Special situations

In accordance with the laws of physics, the accelerating ability is restricted more and more as the heel angle increases. Consequently, there can be a perceptible lag in acceleration out of very tight bends.

The speeds of the front and rear wheels are compared as one means of detecting the rear wheel's incipient tendency to spin or slip sideways. If the system registers implausible values for a lengthy period the ASC

function is deactivated for safety reasons and an ASC fault message is issued. Self-diagnosis has to complete before fault messages can be issued. The BMW Motorrad ASC can shut down automatically under the exceptional riding conditions outlined below.

Exceptional riding conditions:

- Riding for a lengthy period with the rear wheel lifted off the ground (wheelie) with ASC deactivated.
- Rear wheel rotating with the vehicle held stationary by applying the front brake (burn-out).
- Heating up with the motorcycle on the centre stand or an auxiliary stand, engine idling or with a gear engaged.

Accelerating the motorcycle to a speed in excess of 10 km/h after switching the ignition off and then on again reactivates the ASC.

Slip can be increased by very-heavy-duty massive-bar tyres, with the result that ASC intervention occurs before optimum forward acceleration is achieved. Under these circumstances, BMW Motorrad ASC should be deactivated.

If the front wheel lifts clear of the ground under severe acceleration, ASC reduces engine torque until the front wheel regains contact with the ground. Under these circumstances, BMW Motorrad recommends rolling the throttle slightly closed so as to restore stability with the least possible delay.

When riding on a slippery surface, never snap the throttle twistgrip fully closed without pulling the clutch at the same time. Engine braking torque can cause the rear wheel to lock, with a corresponding loss of stability. BMW Motorrad ASC is unable to control a situation of this nature.

Tyre pressure monitoring RDC

– with tyre pressure monitoring (RDC)^{OE}

Function

A sensor integrated into each tyre measures the air temperature and the air pressure inside the tyre and transmits this information to the control unit. Each sensor has a centrifugal-force tripswitch that does not enable transmission of the measured values until the motorcycle has accelerated to above approx-

imately 30 km/h for the first time. The display shows -- for each tyre until the tyre-pressure signal is received for the first time. The sensors continue to transmit the measured-value signals for approximately 15 minutes after the vehicle comes to a stop.

The control unit can administer four sensors, so two different sets of wheels with RDC sensors can be alternated on the vehicle. An error message is issued if wheels without sensors are fitted to a vehicle equipped with an RDC control unit.

Tyre-pressure ranges

The RDC control unit differentiates between three tyre-pressure ranges, all of which are parameterised for the motorcycle:

- Tyre pressure within permitted tolerance.
- Tyre pressure close to limit of permitted tolerance.

– Tyre pressure outside permitted tolerance.

Temperature compensation

Tyre pressure is a temperature-sensitive variable: pressure increases as tyre temperature rises and decreases as tyre temperature drops. Tyre temperature depends on ambient temperature as well as on the style of riding and the duration of the ride.

The tyre-pressure readings shown by the multifunction display are temperature-compensated; the reference tyre temperature for these readings is always 20 °C. The air lines available to the public in petrol stations and motorway service areas have gauges that do not compensate for temperature; the reading shown by a gauge of this nature is the temperature-dependent tyre pressure. In

most instances, therefore, these gauge readings will not tally with the pressures shown by the multifunction display.

the tyre is inflated to the correct pressure.

Pressure adaptation

Compare the RDC readings on the multifunction display with the value in the table on the inside cover of the Rider's Manual. Then use the air line to compensate for the difference between the RDC reading and the value in the table.

Example: According to the Rider's Manual, tyre pressure should be 2.5 bar, but the reading in the multifunction display is 2.3 bar, so pressure is low by 0.2 bar. The gauge on the air line shows 2.4 bar. You must now increase tyre pressure by the 0.2 bar difference between the value in the table and the RDC reading; when the air-line gauge shows 2.6 bar,

Accessories

General instructions.....	102
Power sockets	102
Cases.....	103
Topcase	106
Navigation system	109

General instructions

BMW Motorrad recommends the use of parts and accessories for your motorcycle that are approved by BMW for this purpose. Genuine BMW parts and accessories and other products which BMW has approved can be obtained from your authorised BMW Motorrad dealer, together with expert advice on their installation and use.

These parts and products have been tested by BMW for safety, function and suitability. BMW accepts product liability for them. Conversely, BMW is unable to accept any liability whatsoever for parts and accessories which it has not approved.

Also bear in mind the information on the effect of wheel size on chassis and suspension control systems (►► 123).



BMW Motorrad cannot examine or test each product of outside origin to ensure that it can be used on or in connection with BMW motorcycles without constituting a safety hazard. Country-specific official authorisation does not suffice as assurance. Tests conducted by these instances cannot make provision for all operating conditions experienced by BMW motorcycles and, consequently, they are not sufficient in some circumstances. Use only parts and accessories approved by BMW for your motorcycle. ◀

Whenever you are planning modifications, comply with all the legal requirements. Make sure that the vehicle does not infringe the national road-vehicle construction and use regulations applicable in your country.

Power sockets

Notes on use of power sockets:

Automatic shutdown

Power sockets are shut down automatically under the following circumstances:

- If battery charge state is too low to maintain the motorcycle's start capability
- If maximum load capability as stated in the technical data is exceeded
- When the engine is being cranked on the starter

– with extra socket^{OA}

If more than one socket is used, total current must not exceed the maximum load capability.

Operating electrical accessories

You can start using electrical accessories only when the ignition is switched on. The accessory

remains operational if the ignition is subsequently switched off. The power sockets are switched off approximately 15 minutes after the ignition is switched off, in order to prevent overloading of the on-board electrics.

Cable routing

The cables from the power sockets to the auxiliary devices must be routed in such a way that they:

- Do not impede the rider
- Do not restrict the steering angle or obstruct handling
- Cannot be trapped

Cases

- with cases^{OA}

Opening cases

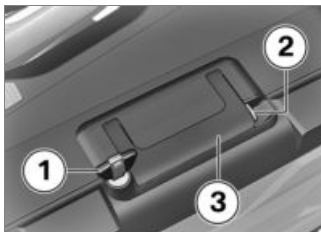

- Turn key **1** in the case lock to right angles with the forward direction of travel.
- Keep the yellow latch **2** held and fold out the carry handle **3**.



- Push yellow button **1** down and at the same time open the lid of the case.

Closing cases

- Turn the lock with the key until it is at right angles to the forward direction of travel.
- Close the case lid.
 - » The lid engages with an audible click.



! Closing the carry handle while the case lock is in line with the forward direction of travel can result in damage to the locking tongue.

Make sure that the case lock is at right angles to the forward direction of travel when you close the carry handle. ◀

- Close carry handle **1**.
- Turn the key in the case lock in line with the forward direction of travel and remove the key from the lock.

Adjusting case volume

- Open the case and remove all its contents.



- Engage pivot lever **1** at the top limit position to set the case to minimum volume.
- Engage pivot lever **1** at the bottom limit position to set the case to maximum volume.
- Close the case.

Removing cases



- Turn key **1** in the case lock to right angles with the forward direction of travel.
- Keep the yellow latch **2** held and fold out the carry handle **3**.



- Pull red release lever **1** up.
» Latching flap **2** pops up.
- Fully open the latching flap.
- Take a firm grip of the handle and lift the case out of the holder.

Installing cases



- Pull red release lever **1** up.
» Latching flap **2** pops up.
- Fully open the latching flap.

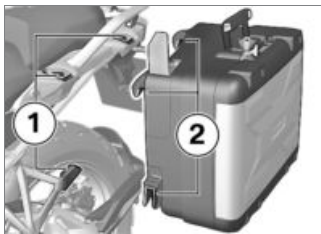

- Place box from the top into the mountings **1** and **2**.

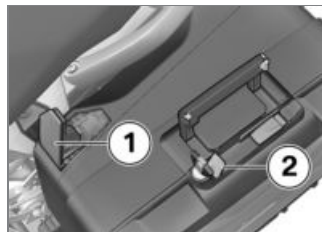

- Press latching flap **1** down until resistance is felt.
- Next simultaneously press down latching flap and red release lever **2**.
» The latching flap engages.



! Closing the carry handle while the case lock is in line with the forward direction of travel can result in damage to the locking tongue.

Make sure that the case lock is at right angles to the forward direction of travel when you close the carry handle. ◀

- Close carry handle **1**.
- Turn the key in the case lock in line with the forward direction of travel and remove the key from the lock.

Topcase

– with topcase^{OA}

Opening topcase

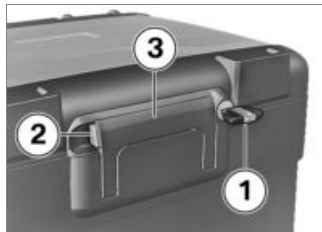

- Turn key **1** in the topcase lock to the vertical position.
- Keep the yellow latch **2** held and fold out the carry handle **3**.

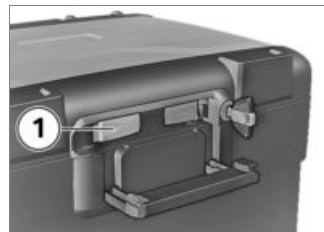

- Push yellow button **1** forward and at the same time open the lid of the topcase.

Closing topcase

- Press down firmly on the topcase lid to close.

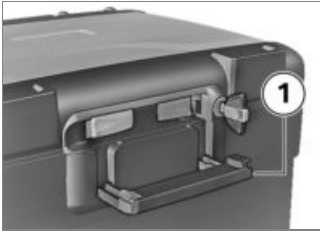

Adjusting topcase volume

- Open the topcase and remove all its contents.



- Engage pivot lever **1** at the front limit position to set the case to maximum volume.
- Engage pivot lever **1** at the rear limit position to set the case to minimum volume.
- Close the topcase.

Removing topcase

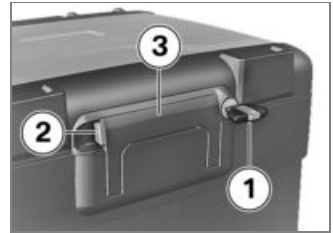

- Turn key **1** in the topcase lock to the vertical position.
- Keep the yellow latch **2** held and fold out the carry handle **3**.



Closing the carry handle while the topcase lock is horizontal can result in damage to the locking tongue.

Make sure that the topcase lock is vertical when you close the carry handle. ◀

- Close carry handle **1**.
 - » The handle engages with an audible click.
- Turn the key in the topcase lock to the horizontal position and remove the key from the lock.

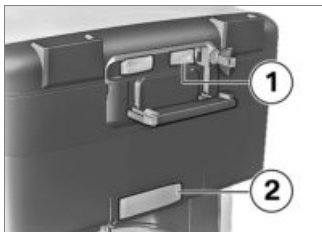

- Pull red lever **1** back as far as it will go.
- » Latching flap **2** pops up.
- Fully open the latching flap.
- Take a firm grip of the handle and lift the topcase out of the holder.

Installing topcase

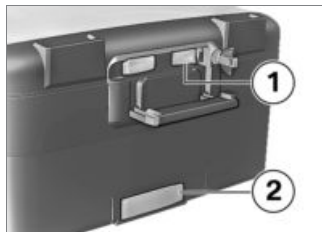

- Pull red lever **1** back as far as it will go.
- » Latching flap **2** pops up.
- Fully open the latching flap.



- Engage the topcase in front holders **1** of the topcase carrier plate.
- Press the topcase onto the topcase carrier plate at the rear.



- Press latching flap **1** forward until resistance is felt.
- Next simultaneously press down latching flap and red release lever **2**.
- » The latching flap engages.



! Closing the carry handle while the topcase lock is horizontal can result in damage to the locking tongue. Make sure that the topcase lock is vertical when you close the carry handle. ◀

- Close carry handle **1**.
- » The handle engages with an audible click.
- Turn the key in the topcase lock to the horizontal position and remove the key from the lock.

Navigation system

– with preparation for navigation system^{OE}

Operating navigation system

If the BMW Motorrad Navigator is fitted, some of its functions can be controlled directly from the handlebars using the Multi-Controller.

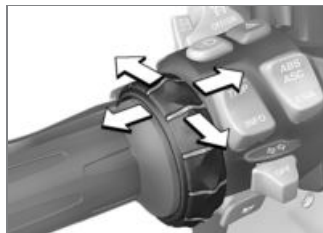

The Multi-Controller is operated by means of six movements:

- Turning upwards and downwards.
- Short operation to the left and right.
- Extended operation to the left and right.

Turning the Multi-Controller increases or decreases the volume of a BMW Motorrad communication system connected via Bluetooth. Whilst the volume is set a bar display appears in the display of the Navigator. In the BMW special menu, the menu items are selected by turning the Multi-Controller.

Short operation of the Multi-Controller to the left or right changes between the main pages of the Navigator:

- Start page
- Mediaplayer
- BMW Special Menu
- Navigation

- Trip computer

The long operation of the Multi-Controller corresponds to the activation of certain functions on the Navigator display. These functions are marked by small arrows above the corresponding contact field or by a plus or minus sign.



The function is triggered by a long operation to the right.



The function is triggered by a long operation to the left.



The function is triggered by a long operation to the right.



The function is triggered by a long operation to the left.

In detail the following functions can be controlled:

Start page

- Operation to the left: start diversion (with active navigation).
- Operation to the right: telephone functions (with a telephone connected).

Mediaplayer

- Operation to the left: Play previous title.
- Operation to the right: Play next title.

BMW Special Menu

- Repeat most recent navigation announcement.
- Save current waypoint as a favourite.
- Navigate home.
- Switch navigation announcements off or on (off: the display shows a loudspeaker symbol that is crossed out).

- Switch navigation display off or on.

Navigation

- Operation to the left: increase map section (Zoom in).
- Operation to the right: reduce map section (Zoom out).

Trip computer

- Operation to the left: scrolling upwards.
- Operation to the right: scrolling down.

Special functions

Integration of the BMW Motorrad Navigator has produced a number of deviations from the descriptions in the user guide for the Navigator.

Reserve fuel level warning

The settings for the fuel gauge enable you to define a distance that is covered per tankful of fuel. The motorcycle sends the fig-

ure for residual range possible with the fuel remaining in the fuel tank to the Navigator, so it is no longer necessary to enter this value.

Time and date

The Navigator sends time and date to the motorcycle. The transfer of these data into the instrument cluster must be activated in the **SETUP** menu of the instrument cluster.

Security settings

The BMW Motorrad Navigator IV can be secured against unauthorised use with a four-digit PIN (Garmin Lock). If this function is activated, while the Navigator is cradled on the motorcycle and the ignition is switched on you are prompted to add the motorcycle to the list of secured vehicles. If you answer "Yes" at this prompt the Navigator saves

the VIN of this vehicle in its internal memory.

A maximum of five VINs can be saved in this way.

Subsequently, the PIN does not have to be entered when the Navigator is switched on by ignition ON while cradled in any of these vehicles.

If the Navigator is removed from the vehicle while switched on, a security prompt asking for the PIN to be entered is issued.

Screen brightness

Screen brightness is adjusted by the motorcycle while the unit is cradled. There is no provision for manual input.

Maintenance

General instructions.....	114
Toolkit	114
Engine oil	115
Brake system	116
Coolant	120
Clutch	122
Rims and tyres.....	122
Wheels	123
Front-wheel stand	129
Bulbs	130
Air filter	135
Jump-start.....	136
Battery.....	137
Fuses	141

General instructions

The "Maintenance" chapter describes straightforward procedures for checking and replacing certain wear parts.

Special tightening torques are listed as applicable. The tightening torques for the threaded fasteners on your vehicle are listed in the section entitled "Technical data".

You will find information on more extensive maintenance and repair work in the Repair Manual on DVD for your vehicle, which is available from your authorised BMW Motorrad dealer.

Some of the work calls for special tools and a thorough knowledge of the technology involved. If you are in doubt consult a specialist workshop, preferably your authorised BMW Motorrad dealer.

Toolkit

Standard tool kit

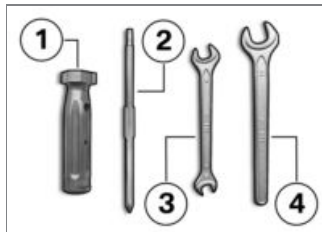

- 1** Screwdriver handle
- Use with screwdriver insert.
 - Top up the engine oil (➡ 116).

- 2** Reversible screwdriver blade
- With cross recess and Torx T25
- Remove turn indicator bulbs, front and rear (➡ 133).
 - Remove battery cover (➡ 139).
- 3** Open-ended spanner
- Width across flats 8/10
- Removing battery (➡ 140).
- 4** Open-ended spanner
- Width across flats 14
- Adjust mirror arm (➡ 66).

Tools service set

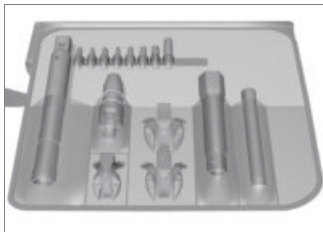

BMW Motorrad has assembled a tools service set that is ideal for carrying out extended service work (e.g. removing and installing wheels) on this motorcycle. You can obtain the tools set from your authorised BMW Motorrad dealer.

Engine oil

Check engine oil level

 The oil level varies with the temperature of the oil. The higher the temperature, the higher the level of oil in the

sump. Checking the oil level with the engine cold or after no more than a short ride will lead to misinterpretation of oil level.

In order to ensure that the engine oil level is read correctly, check the oil level only after at engine operating temperature. ◀

- Switch off the engine when it is at operating temperature.
- Make sure the ground is level and firm and place the motorcycle on its centre stand.
- Wait five minutes for the oil to drain into the oil pan.

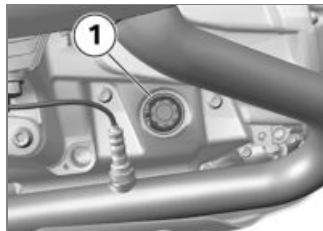

- Check the oil level in oil-level indicator **1**.

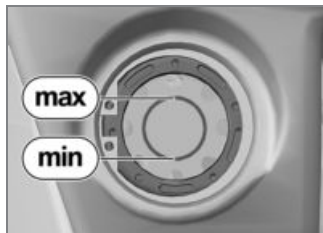

 Engine oil, specified level

– Between MIN and MAX marks

If the oil level is below the MIN mark:

- Top up the engine oil (➡ 116).

If the oil level is above the MAX mark:

- Have the oil level corrected by a specialist workshop, preferably an authorised BMW Motorrad dealer.

Top up the engine oil

- Make sure the ground is level and firm and place the motorcycle on its stand.

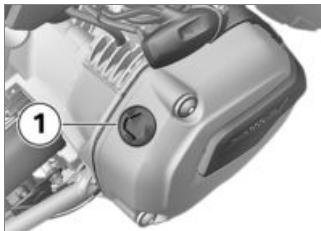

- Wipe the area around the filler neck clean.
- Use the screwdriver handle from the toolkit to remove cap **1** from the engine-oil filler neck.
- Check engine oil level (➡ 115).

! Damage to the engine can result if it is operated without enough oil, but the same also applies if the oil level is too high.

Always make sure that the oil level is correct.◀

- Top up the engine oil to the specified level.



Engine oil, quantity for topping up

– max 0.95 l (Difference between MIN and MAX)

- Check engine oil level (➡ 115).
- Install the cap of the oil filler neck.

Brake system

Check operation of brakes

- Pull the front brake lever.
 - » The pressure point must be clearly perceptible.
- Press the footbrake lever.
 - » The pressure point must be clearly perceptible.

If pressure points are not clearly perceptible:



Incorrect working practices endanger the reliability of the brakes.

Have all work on the brake sys-

tem undertaken by trained and qualified specialists.◀

- Have the brakes checked by a specialist workshop, preferably an authorised BMW Motorrad dealer.

Check front brake pad thickness

- Make sure the ground is level and firm and place the motorcycle on its stand.

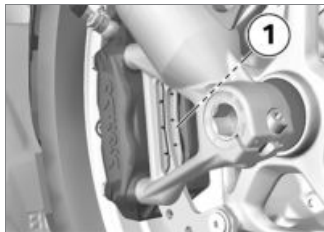

- Visually inspect the left and right brake pads to ascertain their thickness. Viewing direction: between wheel and

front suspension toward brake pads 1.



 Brake-pad wear limit, front

- 1.0 mm (Friction pad only, without backing plate. The wear indicators (grooves) must be clearly visible.)

If the wear indicating marks are no longer clearly visible:



Brake pads worn past the minimum permissible thickness can cause a reduction in braking efficiency and under

certain circumstances they can cause damage to the brake system.

In order to ensure the dependability of the brake system, do not permit the brake pads to wear past the minimum permissible thickness.◀

- Have the brake pads replaced by a specialist workshop, preferably an authorised BMW Motorrad dealer.

Check rear brake pad thickness

- Make sure the ground is level and firm and place the motorcycle on its stand.



- Visually inspect the brake pads to ascertain their thickness. Viewing direction: between spray guard and rear wheel toward brake pads **1**.

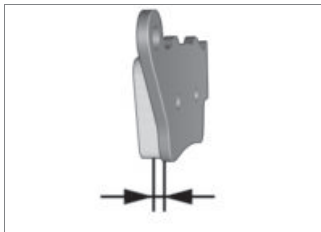

Brake-pad wear limit,
rear

– 1.0 mm (Friction pad only,
without backing plate.)

If the wear limit has been reached:



Brake pads worn past the minimum permissible thickness can cause a reduction in braking efficiency and under certain circumstances they can cause damage to the brake system.

In order to ensure the dependability of the brake system, do not

permit the brake pads to wear past the minimum permissible thickness. ◀

- Have the brake pads replaced by a specialist workshop, preferably an authorised BMW Motorrad dealer.

Check brake-fluid level, front brakes



A low fluid level in the brake reservoir can allow air to penetrate the brake system. This significantly reduces braking efficiency.

Check the brake-fluid level at regular intervals. ◀

- Make sure the ground is level and firm and place the motorcycle on its centre stand.
- Move the handlebars to the straight-ahead position.



- Check the brake fluid level in front reservoir **1**.

▶ Wear of the brake pads causes the brake fluid level in the reservoir to sink.◀



 Brake fluid level, front
– Brake fluid, DOT4
– It is impermissible for the brake fluid level to drop below the MIN mark. (Brake-fluid reservoir horizontal, motorcycle upright)

If the brake fluid level drops below the permitted level:

- Have the defect rectified as quickly as possible by a specialist workshop, preferably an authorised BMW Motorrad dealer.

Check the brake-fluid level, rear brakes

 A low fluid level in the brake reservoir can allow air to penetrate the brake system. This significantly reduces braking efficiency.

Check the brake-fluid level at regular intervals.◀

- Make sure the ground is level and firm and place the motorcycle on its centre stand.



- Check the brake fluid level in rear reservoir **1**.

▶ Wear of the brake pads causes the brake fluid level in the reservoir to sink.◀



Brake fluid level, rear

– Brake fluid, DOT4

– It is impermissible for the brake fluid level to drop below the MIN mark. (Brake-fluid reservoir horizontal, motorcycle upright)

If the brake fluid level drops below the permitted level:

- Have the defect rectified as quickly as possible by a specialist workshop, preferably an authorised BMW Motorrad dealer.

Coolant

Checking coolant level

- Make sure the ground is level and firm and place the motorcycle on its stand.

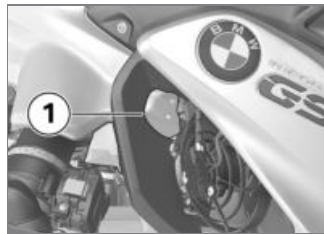

⚠ Risk of burn injuries due to contact with hot engine components.

Keep clear of all hot engine components.

Do not touch hot engine components.◀

- Check the coolant level in expansion tank **1**.

If the coolant drops below the permitted level:

- Top up the coolant.

Topping up coolant

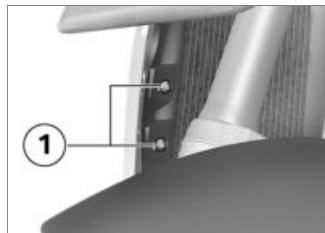

- Remove screws **1**.



- Remove screws **1**.
- Remove side panel in positions **2**, **3** and **4** from the mountings.



- Open cap **1** of the coolant expansion tank and top up the coolant to the specified level.

- Checking coolant level (→ 120).
- Close the cap of the coolant expansion tank.

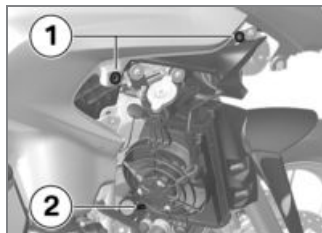

- Place side panel into the mountings **1** and **2**.



- Install screws **1**.

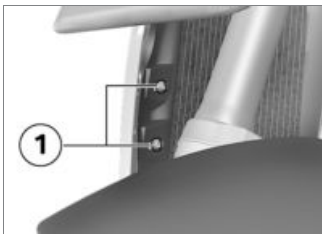

- Install screws **1**.

Clutch

Checking clutch function

- Pull the clutch lever.
 - » The pressure point must be clearly perceptible.
- If the pressure point is not clearly perceptible:
- Have the clutch checked by a specialist workshop, preferably an authorised BMW Motorrad dealer.

Rims and tyres

Checking rims

- Make sure the ground is level and firm and place the motorcycle on its stand.
- Visually inspect the rims for defects.
- Have any damaged rims inspected by a specialist workshop and replaced if necessary, preferably by an authorised BMW Motorrad dealer.

Checking tyre tread depth



Your motorcycle's handling and grip can be impaired even before the tyres wear to the minimum tyre tread depth permitted by law.

Have the tyres changed in good time before they wear to the minimum permissible tread depth. ◀

- Make sure the ground is level and firm and place the motorcycle on its stand.
- Measure the tyre tread depth in the main tread grooves with wear marks.



Wear indicators are built into the main profile grooves on each tyre. The tyre is worn out when the tyre tread has worn down to the level of the marks. The locations of the marks are indicated on the edge of the tyre, e.g. by the letters TI, TWI or by an arrow. ◀

If the tyre tread is worn to minimum:

- Replace tyre or tyres, as applicable.

Check spokes

– with cross-spoked wheels^{OE}

- Make sure the ground is level and firm and place the motorcycle on its stand.
- Draw the handle of a screwdriver or a similar instrument across the spokes and listen to the notes of the individual spokes.

If the notes vary:

- Have the spokes checked by a specialist workshop, preferably an authorised BMW Motorrad dealer.

Wheels

Tyre recommendation

For each size of tyre BMW Motorrad tests and classifies as roadworthy certain makes. BMW Motorrad cannot assess the suitability or provide any guarantee of road safety for other tyres.

BMW Motorrad recommends using only tyres tested by BMW Motorrad.

You can obtain detailed information from your authorised BMW Motorrad dealer or on the Internet at www.bmw-motorrad.com.

Effect of wheel size on chassis and suspension control systems

Wheel size is very important as a parameter for the Chassis and suspension control systems ABS and ASC. In particu-

lar, the diameter and the width of a vehicle's wheels are programmed into the control unit and are fundamental to all calculations. Any change in these influencing variables, caused for example by a switch to wheels other than those installed ex-works, can have serious effects on the performance of the control systems.

The sensor rings are essential for correct road-speed calculation, and they too must match the motorcycle's control systems and consequently cannot be changed.

If you decide that you would like to fit non-standard wheels to your motorcycle, it is very important to consult a specialist workshop beforehand, preferably an authorised BMW Motorrad dealer. In some cases, the data programmed into the control

units can be changed to suit the new wheel sizes.

RDC label

- with tyre pressure monitoring (RDC)^{OE}

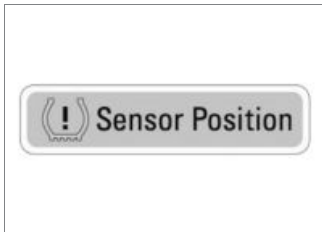

 Incorrect tyre fitting can damage the RDC sensors. Be sure to explain to the authorised BMW Motorrad dealer or the specialist workshop that the wheel is fitted with an RDC sensor.◀

If the motorcycle is equipped with RDC, each wheel rim bears an adhesive label indicating the

position of the RDC sensor. When changing the tyre, take care not to damage the RDC sensor. Be sure to draw the attention of the authorised BMW Motorrad dealer or specialist workshop to the fact that the wheel is fitted with an RDC sensor.

Removing front wheel

- Make sure the ground is level and firm and place the motorcycle on its centre stand.

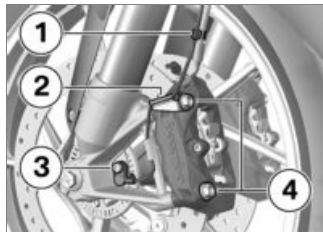

- Remove ABS sensor line from the retaining clips **1** and **2**.

- Remove screw **3** and remove the ABS sensor from its bore.
- Mask off the parts of the wheel rim that could be scratched in the process of removing the brake calipers.

 Once the calipers have been removed, there is a risk of the brake pads being pressed together to the extent that they cannot be slipped back over the brake disc on reassembly.

Do not operate the handbrake lever when the brake calipers have been removed.◀

- Remove securing screws **4** of the left and right brake calipers.

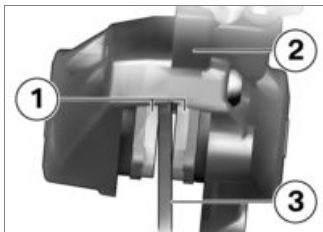

- Force the brake pads **1** slightly apart by rotational movement of the brake caliper **2** against brake disc **3**.
- Carefully pull the brake calipers back and out until clear of the brake discs.
- Raise front of motorcycle until the front wheel can turn freely. BMW Motorrad recommends the BMW Motorrad front-wheel stand for lifting the motorcycle.
- Install the front-wheel stand (▣▣▣ 129).



- Remove right-hand axle clamping screw **1**.

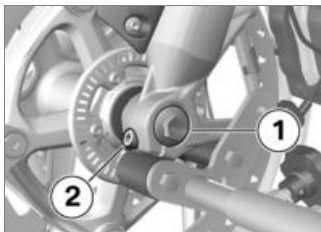

- Remove screw **1**.
- Remove left-hand axle clamping screw **2**.
- Press quick-release axle slightly toward the inside, so as to be

better able to grip it on the right-hand side.



- Withdraw quick-release axle **1**, support the front wheel when doing this.
- Set down front wheel and roll forwards out of the front suspension.



- Remove spacer bush **1** from the wheel hub.

Installing front wheel

! Possible malfunctions when ABS and ASC intervene, if any other wheel but the series standard wheel is installed.

See the information on the effect of wheel size on chassis and suspension control units ABS and ASC at the start of this chapter.◀

! Threaded fasteners not tightened to the specified torque can work loose or their threads can suffer damage.

Always have the security of the fasteners checked by a specialist workshop, preferably an authorised BMW Motorrad dealer.◀

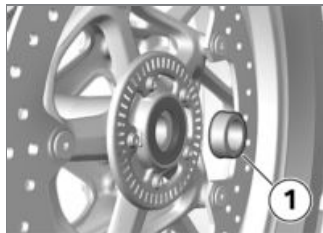

- Slip spacing bushing **1** into the wheel hub on the left-hand side.

! The front wheel must be installed right way round to rotate in the correct direction. Note the direction-of-rotation arrows on the tyre or the wheel rim.◀

- Roll the front wheel into position between the front forks.

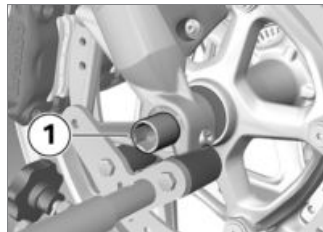

- Lift front wheel and fit quick-release axle **1**.
- Remove front-wheel stand and firmly compress front forks several times. Do not operate front break lever.
- Install the front-wheel stand (➡ 129).

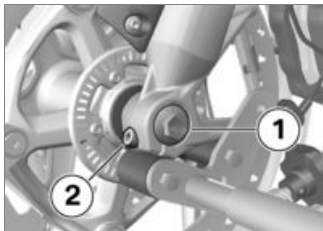

- Install screw **1** and tighten to specified torque. Counter-hold quick-release axle on the right-hand side.

 Quick-release axle in telescopic forks

– 30 Nm

- Tighten left-hand axle clamping screw **2** to the specified torque.

 Clamping screw for quick-release axle in telescopic fork

– 19 Nm



- Tighten right axle clamping screw **1** to the specified torque.

 Clamping screw for quick-release axle in telescopic fork

– 19 Nm

- Remove the front-wheel stand.
- Place brake calipers left and right onto the brake discs.

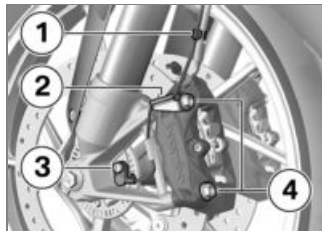

- Install securing screws **4** on left and right and tighten to specified tightening torque.

 Brake caliper on telescopic fork

– 38 Nm

- Remove the adhesive tape from the wheel rim.

 Braking efficiency is impaired if the brake pads are not correctly bedded against the discs.

Before riding off, always check that the brakes bite as soon as

the brake lever is pulled or the brake pedal depressed. ◀

- Operate the brake several times until the brake pads are bedded.
- Fit ABS sensor line into the mounting clips **1** and **2**.
- Insert the ABS sensor into its bore and install screw **3**.

Removing rear wheel

- Make sure the ground is level and firm and place the motorcycle on its centre stand.
- Engage first gear.



Risk of burning due to hot exhaust system.

Do not touch any hot parts of the exhaust system. ◀

- Allow rear silencer to cool down.



- Remove studs **1** from the rear wheel, while supporting the wheel.
- Roll the rear wheel out toward the rear.

Install the rear wheel



Possible malfunctions when ABS and ASC intervene, if any other wheel but the series standard wheel is installed.

See the information on the effect of wheel size on chassis and suspension control units ABS and ASC at the start of this chapter. ◀



Threaded fasteners not tightened to the specified torque can work loose or their threads can suffer damage. Always have the security of the fasteners checked by a specialist workshop, preferably an authorised BMW Motorrad dealer. ◀

- Seat the rear wheel on the rear-wheel adapter.



The wheel studs for the spoked wheel and the cast wheel are of different lengths. If wheel studs from the two sets are combined or the wrong wheel studs are used the

rear wheel will not be correctly secured and could present a risk of accident.

Use only the correct wheel studs and only wheel studs bearing the same approved length identifiers. Do not lubricate the wheel studs. ◀

- Install wheel studs **1** and tighten to specified torque.



Rear wheel to wheel flange

– Tightening sequence:
tighten in diagonally
opposite sequence

– 60 Nm

Front-wheel stand

Install the front-wheel stand

 The BMW Motorrad front wheel stand is not designed to support motorcycles not fitted

with a centre stand or without other auxiliary stands. A motorcycle resting only on the front wheel stand and the rear wheel can topple.

Place the motorcycle on its centre stand or another auxiliary stand before lifting the front wheel with the BMW Motorrad front-wheel stand. ◀

- Make sure the ground is level and firm and place the motorcycle on its centre stand.
- Use basic stand with front-wheel adapter. The basic stand and its accessory parts are available from your BMW Motorrad dealer.

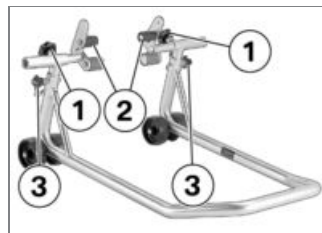

- Slacken adjusting screws **1**.
- Push the two adapters **2** apart until the front forks fit between them.
- Use locating pins **3** to set the front-wheel stand to the desired height.
- Centre the front-wheel stand relative to the front wheel and push it against the front axle.

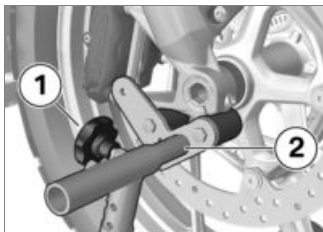

- Align the two adapters **2** so that the front forks are securely seated.
- Tighten adjusting screws **1**.

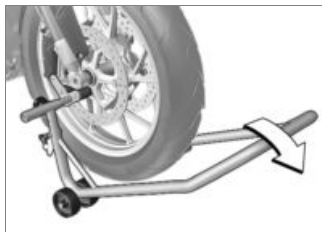

- !** If the motorcycle is on the centre stand and is raised too far, the centre stand will lift clear of the ground and the motorcycle could topple to one side. When raising the motorcycle, make sure that the centre stand remains on the ground.◀
- Apply uniform pressure to push the front-wheel stand down and raise the motorcycle.

Bulbs

Replacing low-beam and high-beam headlight bulb

 The positions of the plug, the spring wire retainer and the bulb might not be as illustrated below.◀

- Make sure the ground is level and firm and place the motorcycle on its stand.
- Switch off the ignition.



- Remove cover **1** by turning it counter-clockwise so as to replace the low beam lamp.



- Remove cover **1** by turning it counter-clockwise so as to replace the high beam lamp.



- Disconnect plug **1**.



- Disengage spring clip **1** and swing it aside.
- Remove bulb **2**.
- Replace the defective bulb.

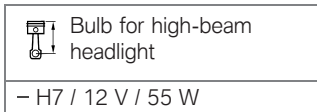
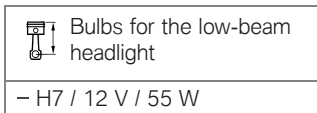

- Hold the new bulb by the base only, in order to keep the glass free of foreign matter.



- Install bulb **2**, making sure that tab **3** is correctly positioned.

The bulb might face in a direction other than that shown here. ◀

- Engage spring clip **1** in the catch.

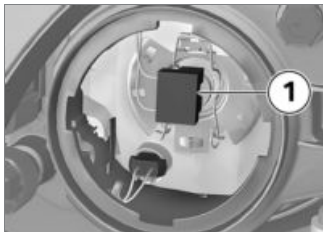

- Install plug **1**.
- Place cover in position and fit by turning in a clockwise direction.

Replacing LED headlight

– with LED headlights^{OE}

- LED headlights can be replaced only as a complete unit. Consult a specialist workshop, preferably an authorised BMW Motorrad dealer.<

Replacing parking-light bulb

- Make sure the ground is level and firm and place the motorcycle on its stand.
- Switch off the ignition.



- Remove cover **1** by turning it counter-clockwise.



- Pull bulb carrier **1** out of the headlight housing.



- Remove bulb **1** from the socket.

- Replace the defective bulb.

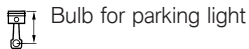

– W5W / 12 V / 5 W

- Use a clean, dry cloth to hold the new bulb in order to keep the glass free of foreign matter.



- Insert bulb **1** into the bulb socket.



- Install bulb carrier **1** in the headlight housing.
- Place cover in position and fit by turning in a clockwise direction.

Replacing LED for brake light and tail light

The LED rear light can be replaced only as a complete unit.

- Consult a specialist workshop, preferably an authorised BMW Motorrad dealer.

Replace LED flashing turn indicators

- with LED turn indicators^{OE}
- The LED flashing turn indicators can be replaced only as a complete unit. Consult a specialist workshop, preferably an authorised BMW Motorrad dealer.<

Remove turn indicator bulbs, front and rear

- Make sure the ground is level and firm and place the motorcycle on its stand.
- Switch off the ignition.



- Remove screw **1**.



- Pull the glass out of the reflector housing at the threaded-fastener side.

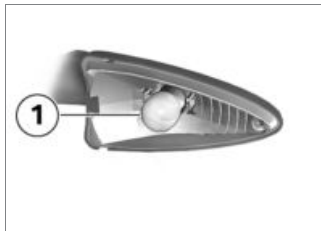

- Turn bulb **1** counter-clockwise and remove it from the bulb housing.

Installing turn-indicator bulbs, front and rear

- Replace the defective bulb.



Bulbs for flashing turn indicators, front

– RY10W / 12 V / 10 W



Bulbs for flashing turn indicators, rear

– RY10W / 12 V / 10 W

- Use a clean, dry cloth to hold the new bulb in order to keep the glass free of foreign matter.

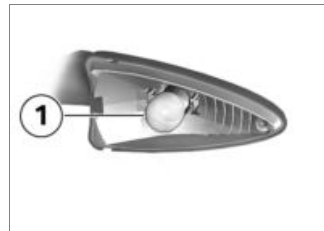

- Turn bulb **1** clockwise to install it in the bulb housing.



- Working from the inboard side, insert the glass into the bulb housing and close the housing.

Replace auxiliary headlights

– with LED auxiliary headlight^{OA}

The LED auxiliary headlights can only be replaced as a unit; it is not possible to replace individual LEDs.

Consult a specialist workshop, preferably an authorised BMW Motorrad dealer.

Air filter

Replacing air-filter element



- Remove front seat (→ 75).

- Remove screws **1** and screws **2**.
- Remove the centre trim panel.

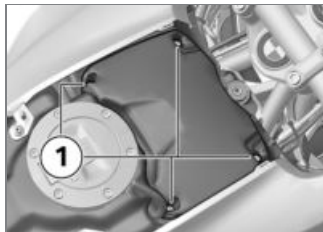

- Remove screws **1**.
- Remove air filter housing cover.

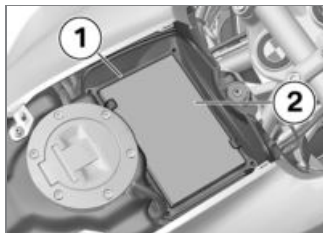

- Remove frame **1**.

- Remove air filter element **2**.

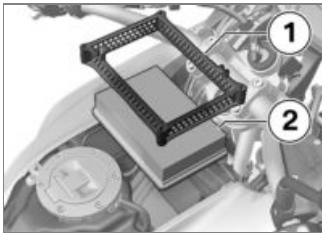

- Fit new or cleaned air filter insert **2**.
- Fit frame **1**.

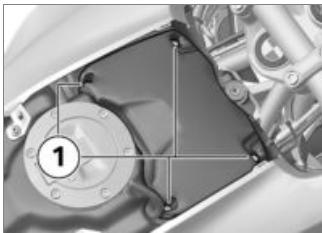

- Place air filter housing cover in position.

- Install screws **1**.

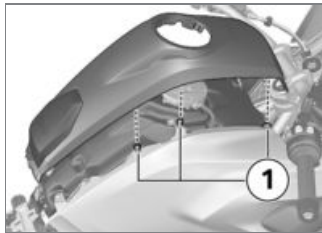

- Place centre trim panel in position, paying attention to the connections **1** to the side panels.



- Fit screws **1** and screws **2**.

- Installing front seat (☞ 75).

Jump-start

⚠ The wires leading to the power socket do not have a load-capacity rating adequate for jump-starting the engine. Excessively high current can lead to a cable fire or damage to the vehicle electronics.

Do not use the on-board socket to jump-start the engine of the motorcycle. ◀

⚠ A short-circuit can result if the crocodile clips of the jump leads are accidentally brought into contact with the motorcycle.

Use only jump leads fitted with fully insulated crocodile clips at both ends. ◀

⚠ Jump-starting with a donor-battery voltage higher than 12 V can damage the vehicle electronics.

Make sure that the battery of the donor vehicle has a voltage rating of 12 V.◀

- Make sure the ground is level and firm and place the motorcycle on its stand.
- Remove battery cover (▶▶▶ 139).
- When jump-starting the engine, do not disconnect the battery from the on-board electrical system.

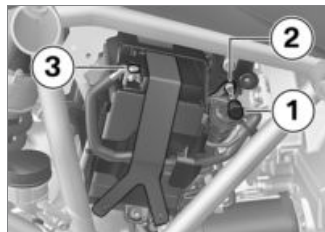

- Remove protective cap of the positive terminal **1**.
- Use the red jumper cable to connect the positive terminal **2** of the discharged battery to the

positive terminal of the donor battery.

- Then connect one end of the black jump lead to the negative terminal of the donor battery and the other end to negative terminal **3** of the discharged battery.
- Run the engine of the donor vehicle during jump-starting.
- Start the engine of the vehicle with the discharged battery in the usual way; if the engine does not start, wait a few minutes before repeating the attempt in order to protect the starter motor and the donor battery.
- Allow both engines to idle for a few minutes before disconnecting the jump leads.
- Disconnect the jump lead from the negative terminals first, then disconnect the second lead from the positive terminals.

 Do not use proprietary start-assist sprays or other products to start the engine.◀

- Installing front seat (▶▶▶ 75).

Battery

Maintenance instructions

Correct upkeep, recharging and storage will prolong the life of the battery and are essential if warranty claims are to be considered.

Compliance with the points below is important in order to maximise battery life:

- Keep the surface of the battery clean and dry
- Do not open the battery
- Do not top up with water
- Be sure to read and comply with the instructions for charging the battery on the following pages
- Do not turn the battery upside down

 If the battery is not disconnected, the on-board electronics (e.g. clock, etc.) gradually drain the battery. This can cause the battery to run flat. If this happens, warranty claims will not be accepted.

Connect a float charger to the battery if the motorcycle is to remain out of use for more than four weeks. ◀

 BMW Motorrad has developed a float charger specially designed for compatibility with the electronics of your motorcycle. Using this charger, you can keep the battery charged during long periods of disuse, without having to disconnect the battery from the motorcycle's on-board systems. You can obtain additional information from your authorised BMW Motorrad dealer. ◀

Charging battery when connected

 Charging the connected battery directly at the battery terminals can damage the vehicle electronics.

Always disconnect the battery from the on-board circuits before recharging it with a charger connected directly to the battery posts. ◀

 If you switch on the ignition and the multifunction display and indicator lights fail to light up, the battery is completely flat (battery voltage is less than 9 V). Attempting to charge a completely flat battery via the extra socket can cause damage to the motorcycle's electronics. If a battery has discharged to the extent that it is completely flat, it has to be disconnected from the on-board circuits and charged

with the charger connected directly to the battery posts. ◀

 Only chargers suitable for this mode of charging can be used to recharge the battery via the on-board socket. Unsuitable chargers could cause damage to the motorcycle's on-board electrics.

Use BMW suitable chargers. A suitable charger is available from BMW Motorrad your authorised dealer. ◀

- Charge via the power socket, with the battery connected to the motorcycle's on-board electrical system.

 The motorcycle's on-board electronics know when the battery is fully charged. The on-board socket is switched off when this happens. ◀

- Comply with the operating instructions of the charger.

▶ If you are unable to charge the battery through the on-board socket, you may be using a charger that is not compatible with your motorcycle's electronics. If this happens, disconnect the battery from the on-board systems and connect the charger directly to the battery.◀

Charging battery when disconnected

- Charge the battery using a suitable charger.
- Comply with the operating instructions of the charger.
- Once the battery is fully charged, disconnect the charger's terminal clips from the battery terminals.

▶ The battery has to be recharged at regular intervals in the course of a lengthy period of disuse. See the instructions for caring for your battery. Al-

ways fully recharge the battery before restoring it to use◀

Remove battery cover

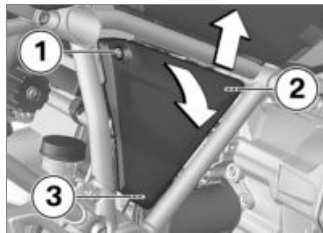

- Remove screw **1**.
- Slightly pull forward battery cover at the top in positions **1** and **2**, in so doing pay attention to the mounting **3**.
- Withdraw battery cover in an upward direction from the mounting **3**.

Fitting battery cover

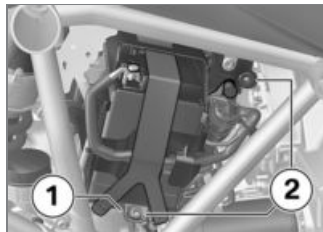

- Place battery cover into the mounting **1** and press into the mountings **2**.

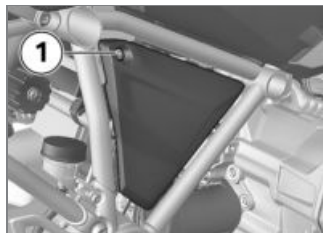

- Install screw **1**.

Removing battery

- with anti-theft alarm^{OE}
- If applicable, switch off the anti-theft alarm.<
- Switch off the ignition.
- Remove battery cover (➔ 139).

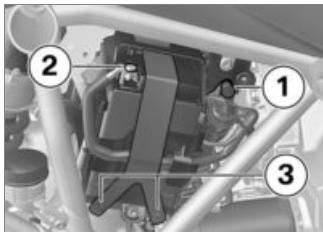

- Remove protective cap **1** of the positive terminal.
- Remove battery negative lead **2**.
- Undo rubber cord **3**.



- Pull retaining plate in position **1** outwards and remove in an upward direction.
- Slightly lift battery and remove from the mounting to such an extent that the battery positive terminal becomes accessible.



- Disconnect positive lead **1**.

Installing battery



- Connect positive lead **1** to the battery's positive terminal.
- Push battery into the mounting.

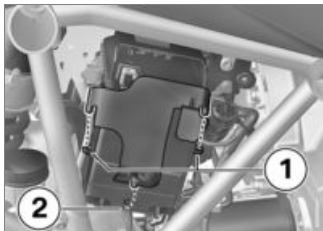

- First insert retaining plate into the mountings **1** and then push under the battery in position **2**.

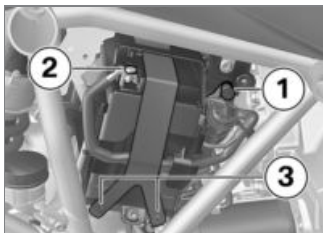

- Fit rubber cord **3**.
- Connect battery negative lead **2**.

- Fit protective cap **1** of the battery positive terminal.
- Fit battery cover (➡ 139).
- Setting clock (➡ 49).
- Set date (➡ 50).

Fuses

Replacing fuses

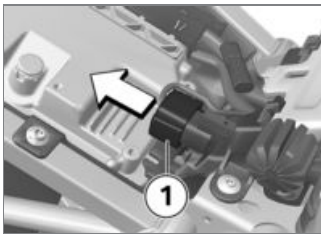

- Switch off the ignition.
- Remove front seat (➡ 75).
- Disconnect plug **1**.

⚠ Any attempt to jumper a defective fuse gives rise to the risk of a short-circuit and fire. Always replace a defective fuse

with a new fuse of the same amperage.◀

- Replace faulty fuse in accordance with the fuse allocation diagram.

▶ If fuse defects recur frequently have the electric circuits checked by a specialist workshop, preferably an authorised BMW Motorrad dealer.◀

- Install plug **1**.
- Installing front seat (➡ 75).

Fuse assignment

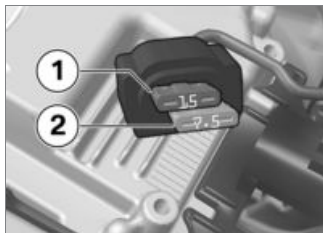

- 1** 15 A
Instrument cluster, alarm system (DWA), ignition lock, diagnostic socket
- 2** 7.5 A
Multifunction switch left, tyre pressure control (RDC)

Care

Care products	144
Washing motorcycle	144
Cleaning easily damaged components.....	144
Paint care	145
Protective wax coating	146
Lay up motorcycle	146
Restoring motorcycle to use	146

Care products

BMW Motorrad recommends that you use the cleaning and care products you can obtain from your authorised BMW Motorrad dealer.

The substances in BMW CareProducts have been tested in laboratories and in practice; they provide optimised care and protection for the materials used in your vehicle.

 The use of unsuitable cleaning and care products can damage vehicle components. Do not use solvents such as cellulose thinners, cold cleaners, fuel or the like, and do not use cleaning products that contain alcohol.◀

Washing motorcycle

BMW Motorrad recommends that you use BMW insect remover to soften and wash off insects and stubborn dirt on painted parts prior to washing the motorcycle.

To prevent stains, do not wash the motorcycle immediately after it has been exposed to strong sunlight and do not wash it in the sun.

Make sure that the vehicle is washed frequently, especially during the winter months.

To remove road salt, clean the motorcycle with cold water immediately after every trip.

 After the motorcycle has been washed, ridden through water or ridden in the rain, the brake discs and pads might be wet and the brakes might not take effect immediately.

Apply the brakes in good time until the brake discs and brake pads have dried out.◀

 Warm water intensifies the effect of salt.

Use only cold water to wash off road salt.◀

 The high pressure of high-pressure cleaners (steam cleaners) can damage seals, the hydraulic brake system, the electrical system, and the seat. Do not use a steam jet or high-pressure cleaning equipment.◀

Cleaning easily damaged components

Plastics

 If plastic parts are cleaned using unsuitable cleaning agents, the surfaces can be damaged.

Do not use cleaning agents that

contain alcohol, solvents or abrasives to clean plastic parts. Even insect-remover pads or cleaning pads with hard surfaces can produce scratches.◀

Body panels

Clean the trim panels with water and BMW plastic care emulsion.

Windscreens and headlight lenses made of plastic

Clean off dirt and insects with a soft sponge and plenty of water.



Soften stubborn dirt and insects by covering the affected areas with a wet cloth.◀



Clean with water and sponge only.



Do not use any chemical cleaning agents.

Chrome

Use plenty of water and BMW shampoo to clean chrome, particularly if it has been exposed to road salt. Use chrome polish for additional treatment.

Radiator

Clean the radiator regularly to prevent overheating of the engine due to inadequate cooling. For example, use a garden hose with low water pressure.



Cooling fins can be bent easily.

Take care not to bend the fins when cleaning the radiator.◀

Rubber

Treat rubber components with water or BMW rubber-care products.



Using silicone sprays for the care of rubber seals can cause damage.

Do not use silicone sprays or care products that contain silicon.◀

Paint care

Washing the vehicle regularly will help counteract the long-term effects of substances that damage the paint, especially if your vehicle is ridden in areas with high air pollution or natural sources of dirt, for example tree resin or pollen.

Remove particularly aggressive substances immediately, however, as otherwise the paint can be affected or become discoloured. Substances of this nature include spilt fuel, oil, grease, brake fluid and bird droppings. We recommend BMW vehicle polish or BMW paint cleaner for this purpose.

Marks on the paintwork are particularly easy to see after the motorcycle has been washed.

Technical data

Troubleshooting chart	148
Threaded fasteners	149
Engine	151
Fuel.....	152
Engine oil	153
Clutch	153
Transmission	154
Rear-wheel drive.....	154
Running gear	155
Brakes	157
Wheels and tyres	157
Electrics	158
Anti-theft alarm	160
Frame	160
Dimensions	161

Weights.....	162
Riding specifications	162

Troubleshooting chart

Engine does not start or is difficult to start.

Possible cause	Rectification
Kill switch activated	Set emergency-off switch (kill switch) to operating position.
Side stand extended and gear engaged	Retract the side stand.
Gear engaged and clutch not disengaged	Select neutral or pull the clutch lever.
No fuel in tank	Refuel (▮▮▮ 86).
Battery flat	Charging battery when connected (▮▮▮ 138).

Threaded fasteners

Front wheel	Value	Valid
Brake caliper on telescopic fork		
M10 x 65	38 Nm	
Clamping screw for quick-release axle in telescopic fork		
M8 x 35	19 Nm	
Rear wheel	Value	Valid
Rear wheel to wheel flange		
M10 x 1.25 x 40	tighten in diagonally opposite sequence	
	60 Nm	
Mirror arm	Value	Valid
Mirror (lock nut) to adapter		
Left-hand thread, M10 x 1.25	22 Nm	
Adapter to clamping block		
M10 x 14 - 4.8	25 Nm	

Handlebars	Value	Valid
Clamping block (handlebar clamp) on fork bridge		
M8 x 35	tighten in riding direction at the front of the block	
	19 Nm	

Engine

Engine design	Air- / fluid-cooled two-cylinder four-stroke opposed-twin engine with two upper spur-gear-driven camshafts and a counterbalance shaft.
Displacement	1170 cm ³
Cylinder bore	101 mm
Piston stroke	73 mm
Compression ratio	12.5:1
Nominal output	92 kW, at engine speed: 7750 min ⁻¹
Torque	125 Nm, at engine speed: 6500 min ⁻¹
Maximum engine speed	max 9000 min ⁻¹
Idle speed	1150 min ⁻¹ , Engine at regular operating temperature

Fuel

Recommended fuel grade	Super unleaded (max. 10 % ethanol, E10) 95 ROZ/RON 89 AKI
Alternative fuel grade	Regular unleaded (Power- and consumption-related restrictions. If e.g. the engine is to be operated in countries with low fuel grades at 91 research octane number, then the motorcycle must first be programmed appropriately at your authorised BMW motorcycle dealer.) 91 ROZ/RON 87 AKI
Usable fuel capacity	approx. 20 l
Reserve fuel	approx. 4 l

BMW recommends BP fuels



Engine oil

Engine oil, capacity	approx. 4.2 l, with filter change
Products recommended by BMW Motorrad	
Castrol Power 1 Racing	SAE 5W-40, API SL / JASO MA2
Engine oil, quantity for topping up	max 0.95 l, Difference between MIN and MAX

BMW recommends 

Clutch

Clutch type	Multiplate clutch running in oil bath
-------------	---------------------------------------

Transmission

Gearbox type	Helical 6-speed transmission, integrated in the engine housing
Gearbox transmission ratios	1,650, Primary transmission ratio 2.438 (39:16 teeth), 1st gear 1.714 (36:21 teeth), 2nd gear 1.296 (35:27 teeth), 3rd gear 1.059 (36:34 teeth), 4th gear 0.943 (33:35 teeth), 5th gear 0.848 (28:33 teeth), 6th gear 1.061 (35:33 teeth), Transmission output ratio

Rear-wheel drive

Type of final drive	Shaft drive with bevel gears
Type of rear suspension	Cast-aluminium single swinging arm with BMW Motorrad Paralever
Gear ratio of final drive	2.910 (32:11 teeth)

Running gear

Front wheel

Type of front suspension	BMW Telelever, with anti-dive top fork bridge, trailing arm mounted on engine and telescopic forks, central spring strut supported by trailing arm and frame
Design of front wheel suspension	Central shock absorber with helical spring
– with Dynamic ESA ^{OE}	Central shock absorber complete with torsion spring and header tank, electrically adjustable de-compression and compression-stage damping
Spring travel, front	190 mm, At wheel
– with lowered suspension ^{OE}	160 mm, At wheel

Rear wheel

Type of rear suspension	Cast-aluminium single swinging arm with BMW Motorrad Paralever
Type of rear suspension	Central shock absorber complete with torsion spring, adjustable rebound-stage damping and spring preload
– with Dynamic ESA ^{OE}	Central shock absorber complete with torsion spring and header tank, electrically adjustable decompression and compression-stage damping, electrically adjustable spring preload
Spring travel at rear wheel	200 mm
– with lowered suspension ^{OE}	170 mm

Brakes

Type of front brake	Hydraulically operated twin disc brake with 4-piston radial monobloc calipers and floating brake discs
Brake-pad material, front	Sintered metal
Type of rear brake	Hydraulically operated disc brake with 2-piston floating caliper and fixed disc
Brake-pad material, rear	Organic material

Wheels and tyres

Recommended tyre sets	You can obtain an up-to-date list of approved tyres from your authorised BMW Motorrad dealer or on the Internet at " www.bmw-motorrad.com "
-----------------------	---

Front wheel

Front wheel type	Aluminium cast wheel
– with cross-spoked wheels ^{OE}	Cross-spoked wheel
Front wheel rim size	3.0"x19"
Tyre designation, front	120/70 - 19

Rear wheel

Rear wheel type	Aluminium cast wheel
– with cross-spoked wheels ^{OE}	Cross-spoked wheel
Rear wheel rim size	4.50"x17"
Tyre designation, rear	170/60 - 17

Tyre pressures

Tyre pressure, front	2.5 bar, Tyre cold
Tyre pressure, rear	2.9 bar, Tyre cold

Electrics

Electrical rating of on-board sockets	max 5 A, Total for all sockets
Fuse box	15 A, Slot 1: instrument cluster, alarm system (DWA), ignition lock, diagnostic socket 7.5 A, Slot 2: multifunction switch left, tyre pressure control (RDC)

Battery

Battery type	AGM (Absorbent Glass Mat) battery
Battery rated voltage	12 V
Battery rated capacity	12 Ah

Spark plugs

Spark plugs, manufacturer and designation	NGK LMAR8D-J
---	--------------

Electrode gap of spark plug	0.8 \pm 0.1 mm
-----------------------------	------------------

Lighting

Bulb for high-beam headlight	H7 / 12 V / 55 W
------------------------------	------------------

Bulbs for the low-beam headlight	H7 / 12 V / 55 W
----------------------------------	------------------

Bulb for parking light	W5W / 12 V / 5 W
------------------------	------------------

Bulb for tail light/brake light	LED / 12 V
---------------------------------	------------

Bulbs for flashing turn indicators, front	RY10W / 12 V / 10 W
---	---------------------

Bulbs for flashing turn indicators, rear	RY10W / 12 V / 10 W
--	---------------------

Anti-theft alarm

Time to active after activation	approx. 30 s
Alarm duration	approx. 26 s
Battery type	CR 123 A

Frame

Frame type	Tubular steel frame with supporting drive unit, steel pipe rear frames
Type plate location	Frame, front, right (supporting pipe)
Location of the vehicle identification number	Front frame (steering head)

Dimensions

Length of motorcycle	2190 mm, about spray guard
Height of motorcycle	1440 mm, To top of windscreen when lowered, at DIN unladen weight
– with lowered suspension ^{OE}	1415 mm, To top of windscreen when lowered, at DIN unladen weight
Width of motorcycle	955 mm, Across mirrors
– with hand protectors ^{OE}	980 mm, about hand guards
Front-seat height	850...870 mm, Without rider at unladen weight
– with front seat, low ^{OE}	820...840 mm, Without rider at unladen weight
– with lowered suspension ^{OE}	790...810 mm, Without rider at unladen weight
Rider's inside-leg arc, heel to heel	1870...1910 mm, Without rider at unladen weight
– with front seat, low ^{OE}	1820...1860 mm, Without rider at unladen weight
– with lowered suspension ^{OE}	1770...1810 mm, Without rider at unladen weight

Weights

Unladen weight	238 kg, DIN unladen weight, ready for road 90 % load of fuel, without OE
Permissible gross weight	450 kg
Maximum payload	212 kg

Riding specifications

Top speed	>200 km/h
-----------	-----------

Service

BMW Motorrad Service	164
BMW Motorrad Mobility services	164
Maintenance work	164
Confirmation of maintenance work	166
Confirmation of service	171

BMW Motorrad Service

BMW Motorrad has an extensive after-sales service network in place to look after you and your motorcycle in more than 100 countries. Authorised BMW Motorrad dealerships have the technical information and the technical know-how to reliably carry out all maintenance and repair work on your BMW. Visit our website www.bmw-motorrad.com to find out where the nearest authorised BMW Motorrad dealership is located.



If maintenance and repair work is performed in- expertly, it could result in con- sequential damage and thus con- stitute a safety risk.

BMW Motorrad recommends you to have all the associated work on your motorcycle carried out by a specialist workshop, prefer-

ably an authorised BMW Motor- rad dealer. ◀

In order to help ensure that your BMW is always in optimum condition, BMW Motorrad recommends compliance with the maintenance intervals specified for your motorcycle. Have all maintenance and repair work carried out confirmed in the "Service" chapter in this manual. For generous treatment of claims submitted after the warranty period has expired, evidence of regular maintenance is essential.

Your authorised BMW Motorrad dealer can provide information on BMW services and the work un- dertaken as part of each service.

BMW Motorrad Mobility services

As owner of a new BMW motorcycle, in circumstances in which assistance is required you can benefit from the protection afforded by the various BMW Motorrad mobility services (e.g. Mobile Service, breakdown service, vehicle recovery service). Your authorised BMW Motorrad dealer will be happy provide in- formation about the mobility ser- vices available to you.

Maintenance work

BMW Pre-delivery Check

Your authorised BMW Motorrad dealer conducts the BMW pre- delivery check before handing over the vehicle to you.

BMW Running-in Check

The BMW running-in check has to be performed when the vehicle has covered between 500 km and 1200 km.

BMW Service

The BMW Service is carried out once a year; the extent of servicing can vary, depending on the age of the vehicle and the distance it has covered. Your authorised BMW Motorrad dealer confirms that the service work has been carried out and enters the date when the next service will be due.

Riders who cover long distances in a year might have to bring in their vehicles for service before the next scheduled date. It is to allow for these cases that a maximum odometer reading is entered as well in the confirmation of service. Servicing has to be brought forward if this odo-

meter reading is reached before the next scheduled date for the service.

The service-due indicator in the multifunction display reminds you about one month or 1000 km in advance when the time for a service is approaching, on the basis of the programmed values.

Confirmation of maintenance work

BMW Pre-delivery Check

Completed

on _____

Stamp, signature

BMW Running-in Check

Completed

on _____

Odometer reading _____

Next service
at the latest

on _____

or, if logged beforehand,

Odometer reading _____

Stamp, signature

BMW Service

Completed

on _____

Odometer reading _____

Next service
at the latest

on _____

or, if logged beforehand,

Odometer reading _____

Stamp, signature**BMW Service**

Completed

on _____

Odometer reading _____

Next service
at the latest

on _____

or, if logged beforehand,

Odometer reading _____

Stamp, signature**BMW Service**

Completed

on _____

Odometer reading _____

Next service
at the latest

on _____

or, if logged beforehand,

Odometer reading _____

Stamp, signature

BMW Service

Completed

on _____

Odometer reading _____

Next service
at the latest

on _____

or, if logged beforehand,

Odometer reading _____

Stamp, signature**BMW Service**

Completed

on _____

Odometer reading _____

Next service
at the latest

on _____

or, if logged beforehand,

Odometer reading _____

Stamp, signature**BMW Service**

Completed

on _____

Odometer reading _____

Next service
at the latest

on _____

or, if logged beforehand,

Odometer reading _____

Stamp, signature

BMW Service

Completed

on _____

Odometer reading _____

Next service
at the latest

on _____

or, if logged beforehand,

Odometer reading _____

Stamp, signature**BMW Service**

Completed

on _____

Odometer reading _____

Next service
at the latest

on _____

or, if logged beforehand,

Odometer reading _____

Stamp, signature**BMW Service**

Completed

on _____

Odometer reading _____

Next service
at the latest

on _____

or, if logged beforehand,

Odometer reading _____

Stamp, signature

BMW Service

Completed

on _____

Odometer reading _____

Next service
at the latest

on _____

or, if logged beforehand,

Odometer reading _____

Stamp, signature**BMW Service**

Completed

on _____

Odometer reading _____

Next service
at the latest

on _____

or, if logged beforehand,

Odometer reading _____

Stamp, signature**BMW Service**

Completed

on _____

Odometer reading _____

Next service
at the latest

on _____

or, if logged beforehand,

Odometer reading _____

Stamp, signature

Confirmation of service

The table is intended as a record of maintenance and repair work, the installation of optional accessories and, if appropriate, special campaign (recall) work.

Item	Odometer reading	Date

Appendix

Certificate..... 174

Certification Tire Pressure Control (TPC)

FCC ID: MRXBC54MA4
IC: 2546A-BC54MA4

FCC ID: MRXBC5A4
IC: 2546A-BC5A4

This device complies with Part 15 of the FCC Rules and with Industry Canada license-exempt RSS standard(s).

Operation is subject to the following two conditions:

- (1) This device may not cause harmful interference, and
- (2) This device must accept any interference received, including interference that may cause undesired operation.

Le présent appareil est conforme aux CNR d'Industrie Canada applicables aux appareils radio exempts de licence. L'exploitation est autorisée aux deux conditions suivantes:

- (1) l'appareil ne doit pas produire de brouillage, et
- (2) l'utilisateur de l'appareil doit accepter tout brouillage radioélectrique subi, même si le brouillage est susceptible d'en compromettre le fonctionnement.

WARNING: Changes or modifications not expressly approved by the party responsible for compliance could void the user's authority to operate the equipment. The term "IC:" before the radio certification number only signifies that Industry Canada technical specifications were met.

- A**
- Abbreviations and symbols, 6
- ABS
 - Control, 14
 - Engineering details, 93
 - Operation, 58
 - Self-diagnosis, 82
 - Warnings, 36
- Accessories
 - General instructions, 102
- Air filter
 - Position on the motorcycle, 13
 - Replace insert, 135
- Ambient temperature
 - Outside temperature warning, 36
 - Reading, 22
- Anti-theft alarm
 - Operation, 71
 - Technical data, 160
 - Telltale light, 18
 - Warning, 40
- ASC
 - Control, 14
 - Engineering details, 96
 - Operation, 59
 - Self-diagnosis, 82
- Average values
 - Resetting, 48
- B**
- Battery
 - Charging battery when connected, 138
 - Charging battery when disconnected, 139
 - Indicator light for battery charge voltage, 35
 - Installation, 140
 - Maintenance instructions, 137
 - Removal, 140
 - Technical data, 158
- Brake fluid
 - Checking fluid level, front, 118
 - Checking fluid level, rear, 119
 - Reservoir, front, 13
 - Reservoir, rear, 13

- Brake pads
 - Checking front, 117
 - Checking rear, 117
 - Running in, 83
- Brakes
 - Adjusting handlebar lever, 65
 - Checking operation, 116
 - Safety instructions, 85
 - Technical data, 157
- Bulbs
 - LED headlight, replacing, 132
 - Replace auxiliary headlights, 135
 - Replacing high-beam headlight bulb, 130
 - Replacing low-beam headlight bulb, 130
 - Replacing parking-light bulb, 132
 - Replacing rear light, 133
 - Technical data, 159
 - Warning, bulb failure, 35

C

- Case
 - Operation, 103
- Checklist, 80
- Clock
 - Adjusting, 49
- Clutch
 - Adjusting handlebar lever, 65
 - Checking operation, 122
 - Technical data, 153
- Confirmation of maintenance work, 166
- Coolant
 - Checking fill level, 120
 - Topping up, 121
 - Warning for overtemperature, 34
- Cruise-control system
 - Operation, 63
- Currency, 7

D

- Damping
 - Adjuster, rear, 11
 - Adjusting, 68

- Daytime riding lights
 - automatic daytime riding light, 55
 - manual daytime riding light, 54
 - Position on the vehicle, 11
- Dimensions
 - Technical data, 161

E

- Electrics
 - Technical data, 158
- Emergency off switch (kill switch), 16
 - Operation, 57
- Engine
 - Indicator light for engine control unit, 34
 - Starting, 81
 - Technical data, 151
 - Warning for engine electronics, 33
- Engine oil
 - Checking fill level, 115
 - Filler neck, 13
 - Fill-level indicator, 13
 - Oil level, 23

- Technical data, 153
 - Topping up, 116
 - Warning for engine oil level, 34
- Equipment, 7
 - ESA
 - Control, 14
 - Operation, 69

F

- Frame
 - Technical data, 160
- Front-wheel stand
 - Installing, 129
- Fuel
 - Filler neck, 11
 - Refuelling, 86
 - Reserve volume, 21
 - Technical data, 152
- Fuel reserve
 - Warning, 33
- Fuses
 - Replacing, 141
 - Technical data, 158

G

- General views
 - Instrument panel, 18
 - Left multifunction switch, 14
 - Left side of vehicle, 11
 - Multifunction display, 20
 - Right multifunction switch, 16
 - Right side of vehicle, 13
 - Underneath the seat, 17
 - Warning and telltale lights, 25
 - Warning symbols, 27

H

- Handlebars
 - Adjusting, 67
- Hazard warning flashers
 - Control, 14, 16
 - Operation, 56
- Headlight
 - Adjustment for driving on left/
driving on right, 73
 - Beam throw, 73
 - Headlight beam-throw
adjustment, 11
- Headlight courtesy delay
feature, 45

Heated handlebar grips

- Control, 16
 - Operation, 57
- ## Horn, 14

I

- ## Ignition
- Switching off, 45
 - Switching on, 45

- ## Immobiliser
- Reserve key, 46
 - Warning, 33

- ## Instrument panel
- Ambient-light brightness
sensor, 18
 - Overview, 18

J

- ## Jump-start, 136

K

- ## Keys, 44

L

- ## Lights
- automatic daytime riding
light, 55
 - Control, 14
 - Headlight flasher, operating, 53
 - High-beam headlight,
operating, 53
 - Low-beam headlight, 53
 - manual daytime riding light, 54
 - Operating auxiliary
headlights, 54
 - Parking light, 53
 - Side light, 53
- ## Lowered suspension
- Restrictions, 78
- ## Luggage
- Instructions for loading, 78

M

- ## Maintenance
- General instructions, 114
- ## Maintenance intervals, 164
- ## Mirrors
- Adjusting, 66
- ## Mobility services, 164

M Motorcycle

- Care, 143
- Cleaning, 143
- Lashing, 88
- Laying up, 146
- Parking, 86
- Multifunction display, 18
 - Control, 14
 - Operation, 46
 - Overview, 20
 - Select display, 46
- Multifunction switch
 - General view, left side , 14
 - General view, right side, 16

O

- Odometer and tripmeters
 - Resetting, 47
- Off-roading, 84

P

- Parking, 86
- Parking light, 53

- Power socket
 - Notes on use, 102
 - Position on the vehicle, 13
- Pre-ride check, 81

R

- Rear-wheel drive
 - Technical data, 154
- Refuelling, 86
- Rev. counter, 18
- Ride mode
 - Adjusting, 60
 - Control, 16
 - Engineering details, 92
- Rider's Manual
 - Position on the vehicle, 17
- Running gear
 - Technical data, 155
- Running in, 83

S

- Safety instructions
 - for brakes, 85
 - For riding, 78

S Seat

- Position of the height adjustment, 17
 - Seats
 - Adjusting seat height, 75
 - Lock, 11
 - Removing and installing, 74
 - Service, 164
 - Service-due indicator, 21
 - Shifting gear
 - Recommendation to upshift, 23
 - Spark plugs
 - Technical data, 159
 - Speedometer, 18
 - Spring preload
 - Adjuster, rear, 13
 - Adjusting, 67
 - Starting, 81
 - Control, 16
 - Steering lock
 - Locking, 44
-
- T** Technical data
 - Anti-theft alarm, 160
 - Battery, 158

- Brakes, 157
- Bulbs, 159
- Clutch, 153
- Dimensions, 161
- Electrics, 158
- Engine, 151
- Engine oil, 153
- Frame, 160
- Fuel, 152
- Rear-wheel drive, 154
- Running gear, 155
- Spark plugs, 159
- Standards, 7
- Transmission, 154
 - Transmission
 - Technical data, 154
 - Troubleshooting chart, 148
 - Turn indicators
 - Control, 14
 - Control, right, 16
 - Operation, 56
 - Type plate
 - Position on the vehicle, 13
 - Tyre pressure monitoring RDC
 - Adhesive label for rim, 124
 - Engineering details, 98
 - Reading, 22
 - Warnings, 38
 - Tyres
 - Checking inflation pressure, 73
 - Checking tread depth, 122
 - Pressures, 158
 - Recommendation, 123
 - Running in, 83
 - Table of tyre pressures, 17
 - Technical data, 157
 - Top speed, 79
- Telltale lights, 18
 - Overview, 25
- Toolkit
 - Contents, 114
 - Position on the vehicle, 17
- topcase
 - Operation, 106
- Torques, 149

V

- Vehicle
 - Restoring to use, 146
- Vehicle Identification Number
 - Position on the vehicle, 13

W

- Warning lights, 18
 - Overview, 25
- Warnings
 - ABS, 36
 - Anti-theft alarm, 40
 - Battery charge voltage, 35
 - Bulb defect, 35
 - Coolant temperature, 34
 - Engine control unit, 34
 - Engine electronics, 33
 - Engine oil level, 34
 - Fuel reserve, 33
 - Immobiliser, 33
 - Mode of presentation, 28
 - Outside temperature warning, 36
 - Overview, 27
 - RDC, 38
- Warnings, overview, 29

Weights

Payload table, 17

Technical data, 162

Wheels

Change of size, 123

Check spokes, 123

Checking rims, 122

Install the rear wheel, 128

Installing front wheel, 126

Removing front wheel, 124

Technical data, 157

Windscreen

Adjuster, 13

Adjusting, 67

Details described or illustrated in this booklet may differ from the vehicle's actual specification as purchased, the accessories fitted or the national-market specification. No claims will be entertained as a result of such discrepancies.

Dimensions, weights, fuel consumption and performance data are quoted to the customary tolerances.

The right to modify designs, equipment and accessories is reserved.

Errors and omissions excepted.

©2013 Bayerische Motoren
Werke Aktiengesellschaft
80788 Munich, Germany

Reprinting, even only in extracts,
is only permitted with written au-
thorization by BMW Motorrad,
Aftersales.

Printed in Germany.

The most important data for a filling-station stop can be found in the following chart:

Fuel	
Recommended fuel grade	Super unleaded (max. 10 % ethanol, E10) 95 ROZ/RON 89 AKI
Alternative fuel grade	Regular unleaded (Power- and consumption-related restrictions. If e.g. the engine is to be operated in countries with low fuel grades at 91 research octane number, then the motorcycle must first be programmed appropriately at your authorised BMW motorcycle dealer.) 91 ROZ/RON 87 AKI
Usable fuel capacity	approx. 20 l
Reserve fuel	approx. 4 l
Tyre pressures	
Tyre pressure, front	2.5 bar, Tyre cold
Tyre pressure, rear	2.9 bar, Tyre cold

BMW recommends 

Order No.: 01 41 8 548 431
02.2013, 3rd edition

