



BMW Motorrad



The Ultimate
Riding Machine

Rider's Manual (US Model)

K 1600 GTL

Motorcycle/Retailer Data

Motorcycle Data

Model

Vehicle identification number

Color number

Initial registration

License plate

Retailer Data

Contact in Service

Ms./Mr.

Phone number

Retailer's address/phone number (company stamp)

Welcome to BMW

Congratulations on choosing a motorcycle from BMW Motorrad and welcome to the community of BMW motorcycle owners and riders. Familiarize yourself with your new motorcycle so that you can ride it safely and confidently in all highway traffic situations.

About this Rider's Manual

Please read this Rider's Manual carefully before starting to use your new BMW. It contains important information on how to operate the controls and how to get the most benefit from your BMW's advanced technical features.

In addition, it contains information on maintenance and care to help you maintain your vehicle's reliability and safety, as well as its value.

Suggestions and complaints

If you have any questions concerning your motorcycle, your authorized BMW Motorrad retailer is always happy to provide advice and assistance.

We wish you many miles of safe and enjoyable riding on your BMW

BMW Motorrad.

01 41 8 522 707



Table of Contents

1 General instructions 5	Oil level indicator 23	Seat 66
Overview 6	Service display 24	Windshield 67
Abbreviations and symbols 6	Warning and indicator lights 26	Wind deflection wing 67
Equipment 7	Warning lights 27	Cruise control 68
Technical data 7	4 Operation..... 43	Hill Start Control 70
Notice concerning current status 7	Steering and ignition lock 45	Storage compartments 71
2 Overviews 9	Ignition 45	Clutch 71
General view, left side 11	Ignition with Keyless Ride 46	Brakes 72
General view, right side 13	Multifunction display 51	Shifting 72
Multifunction switch, left 14	Onboard computer 55	Mirrors 73
Multifunction switch, right 16	Tripmeter 57	Spring preload 73
Underneath seat 17	Lights 57	Damping 74
Instrument cluster 18	Turn indicators 60	ESA Electronic Suspension Adjustment 75
3 Displays 19	Hazard warning flashers 60	Central locking system 76
Multifunction display 20	Emergency ON/OFF switch 61	Alarm system(DWA)..... 80
Meaning of symbols..... 21	Heated handlebar grips 61	Tires 84
Range 22	Seat heating 62	5 Riding..... 87
Ambient temperature..... 22	Dynamic Traction Control (DTC) 64	Safety instructions 88
Tire inflation pressures 23	Riding mode 64	Starting..... 90
		Breaking in 92
		Brakes 93
		Parking your motorcycle 95
		Refueling 96

Securing motorcycle for transport	99				
6 Technology in detail.....	101				
Riding mode	102				
Hill Start Control	103				
Brake system with BMW Motorrad Integral ABS	103				
Engine management with BMW Motorrad DTC	107				
Tire Pressure Control TPC/RDC	108				
ESA II Electronic Suspension Adjustment ...	109				
7 Accessories	111				
General instructions	112				
Onboard power sockets	112				
Navigation device	113				
Case	116				
Topcase	119				
8 Maintenance	123				
General instructions	124				
Onboard tool kit	124				
Engine oil	124				
Brake system	126				
Coolant	130				
Clutch	131				
Wheel rims and tires	132				
Wheels	132				
Front wheel stand	139				
Jump-starting	140				
Light sources	141				
Battery	145				
Fuses	148				
9 Care	151				
Care products	152				
Washing your motorcycle	152				
Cleaning sensitive motorcycle parts	153				
Paint care	153				
Store motorcycle	154				
Protective wax coating	154				
Returning motorcycle to use	154				
10 Technical Data	155				
Troubleshooting chart	156				
Threaded fasteners	157				
Engine	158				
Fuel	159				
Engine oil	159				
Clutch	160				
Transmission	160				
Rear-wheel drive	161				
Suspension	161				
Brakes	162				
Wheels and tires	162				
Electrical system	164				
Anti-Theft Alarm System	166				
Frame	167				
Dimensions	167				
Weights	168				
Performance data	168				
11 Service	169				
Reporting safety defects	170				
BMW Motorrad Service ...	171				
BMW Motorrad Mobility Services	171				

Maintenance procedures	171
Maintenance schedule	175
Standard BMW Service ...	176
Confirmation of maintenance work.....	177
Confirmation of service....	182
12 Appendix.....	185
Certificate for Electronic Immobilizer	186
Certificate for Remote Key.....	188
Certificate for Keyless Ride	192
Certificate for Tire Pressure Control	194
13 Index	195

General instructions

Overview	6
Abbreviations and symbols	6
Equipment	7
Technical data	7
Notice concerning current status	7

Overview

Chapter 2 of this Rider's Manual will provide you with an initial overview of your motorcycle. All maintenance and repair work carried out on your motorcycle will be documented in Chapter 11. Proof of the maintenance work performed is a prerequisite for generous treatment of claims. When the time comes to sell your BMW, please remember to hand over this Rider's Manual; it is an important part of the motorcycle.

Abbreviations and symbols

 **CAUTION** Hazard with low risk. Failure to avoid this hazard can result in minor or moderate injury.



 **WARNING** Hazard with moderate risk. Failure to avoid this hazard can result in death or serious injury.

 **DANGER** Hazard with high risk. Failure to avoid this hazard results in death or serious injury.

 **ATTENTION** Special instructions and precautionary measures. Non-compliance can cause damage to the vehicle or accessories and warranty claims may be denied as a result.

 **NOTICE** Special information on operating and inspecting your motorcycle as well as maintenance and adjustment procedures.

- ◀ Indicates the end of an item of information.
- Instruction.

- » Result of an activity.
- ➔ Reference to a page with more detailed information.
- ◁ Indicates the end of accessory or equipment-dependent information.
-  Tightening torque.
-  Technical data.
- OE Optional extra. BMW Motorrad optional extras are already completely installed during motorcycle production.

OA	Optional accessory. BMW Motorrad optional accessories can be purchased and installed at your authorized BMW Motorrad retailer.
EWS	Electronic immobilizer.
DWA	Anti-theft alarm.
ABS	Anti-Lock Brake System.
DTC	Dynamic Traction Control.
ESA	Electronic Suspension Adjustment.
TPC	Tire Pressure Control (TPC).

Equipment

When you ordered your BMW motorcycle, you chose various items of custom equipment. This Rider's Manual describes optional equipment (OE) offered by BMW and selected optional accessories (OA). This explains why the manual may also contain descriptions of equipment which you have not ordered. Please note, too, that your motorcycle might not be exactly as illustrated in this manual on account of country-specific differences.

If your BMW is equipped with options or accessories not described in this Rider's Manual, then this equipment is described in separate operating instructions.

Technical data

All dimensions, weights and outputs in the Rider's Manual relate to the German DIN standards and comply with their tolerance specifications. Versions for individual countries may differ.

Notice concerning current status







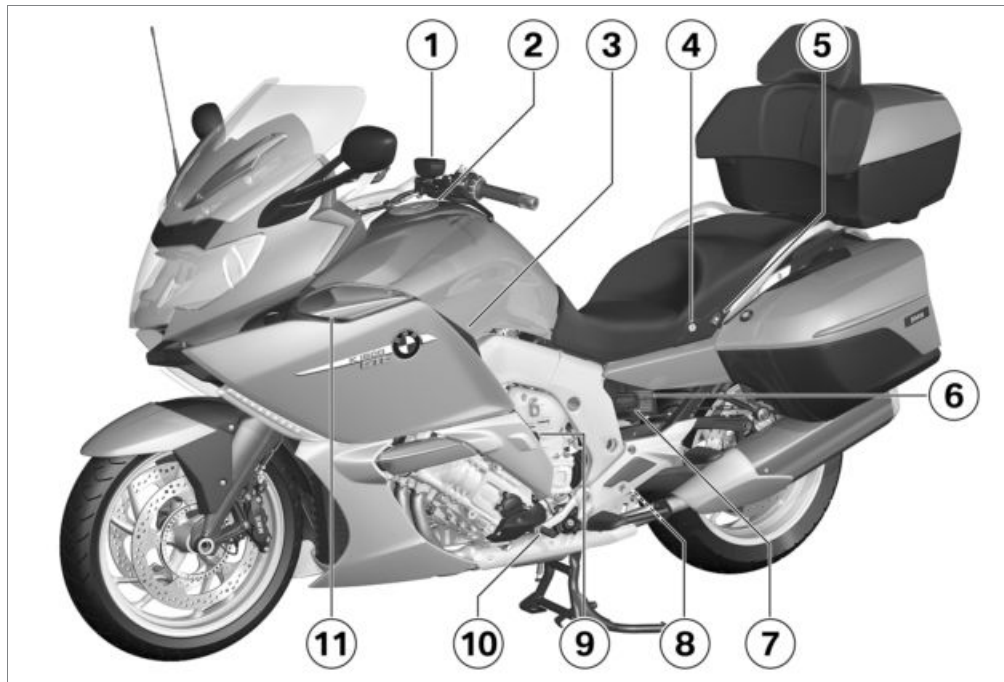

The high safety and quality standards of BMW motorcycles are maintained by consistent, ongoing development efforts embracing their design, equipment and accessories. For this reason, aspects of your motorcycle may vary from the descriptions in this Rider's Manual. In addition, BMW Motorrad cannot guarantee the total absence of errors. We hope you will appreciate that no claims can be recognized based on the data, illustrations or descriptions in this manual.

Overviews

General view, left side.....	11
General view, right side	13
Multifunction switch, left	14
Multifunction switch, right.....	16
Underneath seat	17
Instrument cluster	18



General view, left side

- 1 Clutch fluid reservoir
( 131)
- 2 Fuel filler opening ( 96)
- 3 Operating panel for the audio system (see separate user guide)
- 4 Seat lock ( 66)
- 5 Control for rear-seat heating (on the seat) ( 63)
- 6 Payload table
Tire inflation pressure table
- 7 Adjusting spring preload
( 73)
- 8 Damping adjustment
( 74)
- 9 Storage compartment
( 71)
- 10 Adjustable shift lever
( 72)
- 11 Wind deflection wing
( 67)

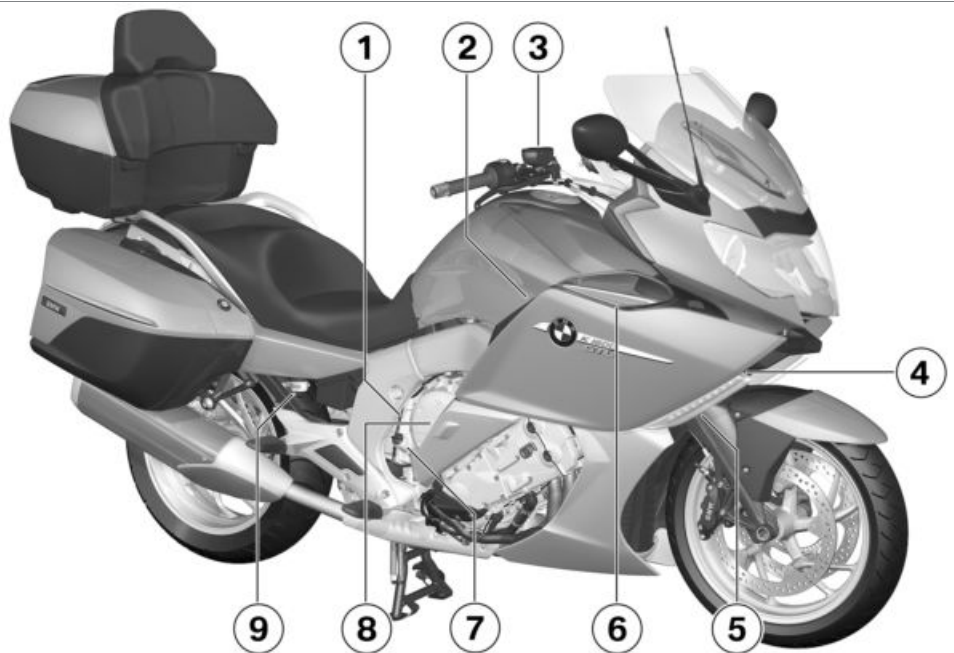

General view, right side

- 1** Vehicle Identification Number (above engine oil filler neck)
- 2** Onboard power socket (▣▶ 112)
- 3** Brake-fluid reservoir, front (▣▶ 128)
- 4** Coolant level indicator (behind side panel) (▣▶ 130)
- 5** Type plate (on front suspension)
- 6** Wind deflection wing (▣▶ 67)
- 7** Engine oil fill location and oil dipstick (▣▶ 124)
- 8** Stowage compartment of the audio system (▣▶ 71)
- 9** Brake-fluid reservoir, rear (▣▶ 129)

Multifunction switch, left

- 1 High-beam headlight and headlight flasher (➔ 57)
- 2 Cruise control (➔ 68)
- 3 Hazard warning flashers (➔ 60)
- 4 – with additional LED headlight^{OE}
or
– with additional LED headlight^{OA}
Operating auxiliary headlights (➔ 59)
- 5 Windshield (➔ 67)
- 6 Turn indicators (➔ 60)
- 7 Horn

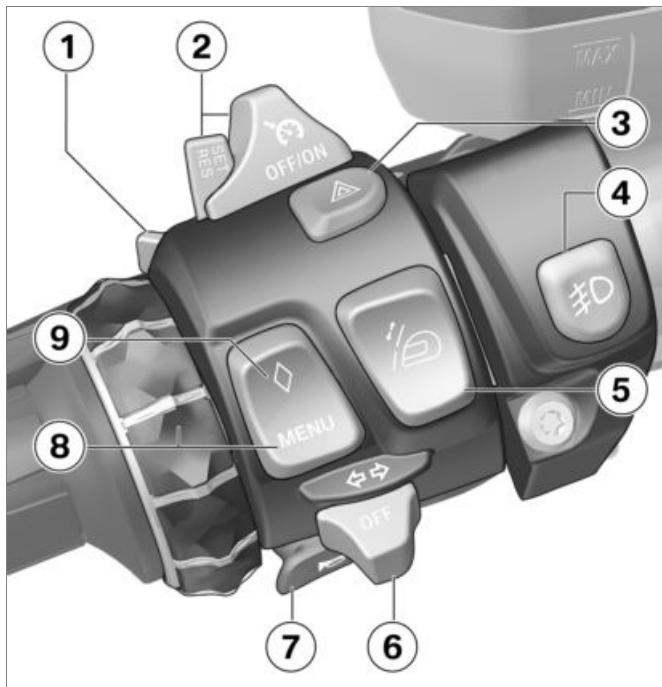

- 8** Multi-controller and MENU button
 - Multifunction display operation (▶▶▶▶ 51)
 - Operation of the audio system (see the appropriate operating instructions)
 - Using DTC (▶▶▶▶ 64)
 - with Electronic Suspension Adjustment (ESA)^{OE}
 - ESA control (▶▶▶▶ 75)
- 9** Selecting favorite menu (▶▶▶▶ 54).

Multifunction switch, right

- 1 – with central locking system^{OE}
Operation of the central locking system (►► 76)
- 2 Selection of the ride mode (►► 64)
- 3 Emergency ON/OFF switch (►► 61)
- 4 Starting the engine (►► 90)



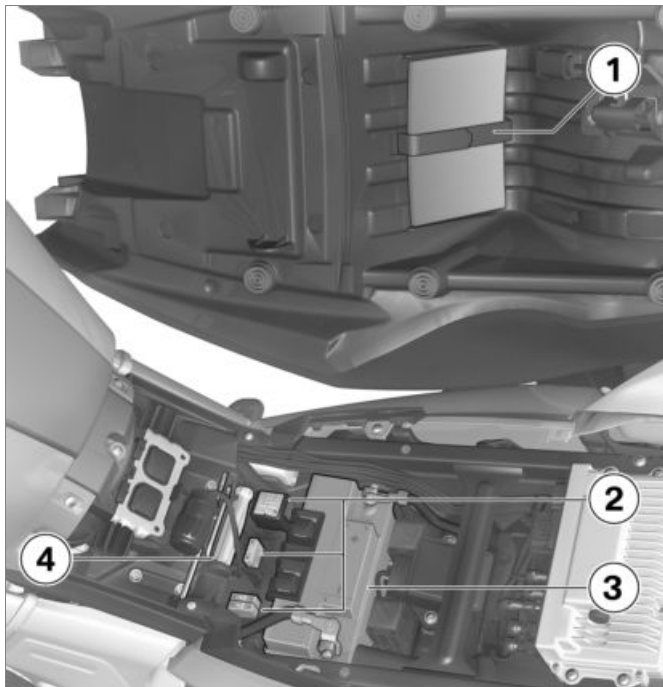

Underneath seat

- 1 Rider's Manual (US Model)
- 2 Fuses (➡ 148)
- 3 Battery (➡ 145)
- 4 Standard tool kit (➡ 124)

Instrument cluster

- 1 Speedometer
- 2 - with preparation for navigation device (OE)
Release for navigation slot
- 3 Warning and indicator lights (☰▶ 26)
- 4 – with navigation system^{OA}
Navigation device (☰▶ 113)
- 5 Photocell (for brightness adjustment of instrument lighting)
- 6 Tachometer
- 7 Multifunction display (☰▶ 20)



NOTICE

The brightness of the warning lights and telltale lights, the display and the instrument needle and gauge lighting is adapted automatically to suit ambient brightness. ◀

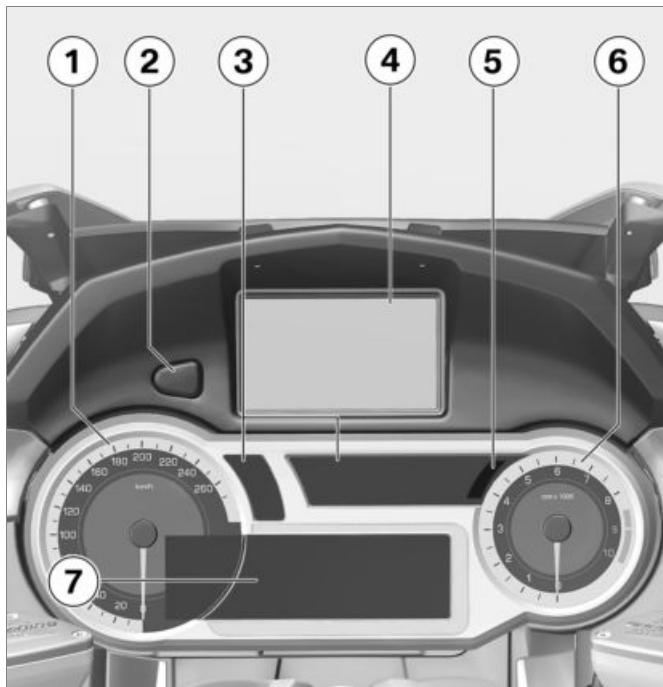

Displays

Multifunction display	20
Meaning of symbols	21
Range	22
Ambient temperature	22
Tire inflation pressures.....	23
Oil level indicator.....	23
Service display.....	24
Warning and indicator lights.....	26
Warning lights	27

Multifunction display

- 1 Riding mode (►►► 64)
- 2 – with Hill Start Control^{OE}
Hill Start Control Operating (►►► 70).
- 3 Coolant temperature
- 4 Warning lights (►►► 27)
- 5 Menu panel (►►► 51)
Area for messages relating to the audio system
- 6 Onboard computer (►►► 55)
– with Tire Pressure Control (TPC/RDC)^{OE}
RDC readings
- 7 Seat heating (►►► 62)
Heated handlebar grips (►►► 61)
– with Electronic Suspension Adjustment (ESA)^{OE}
ESA settings (►►► 75)
- 8 Trip distance (►►► 57)
- 9 Total distance covered
- 10 Clock (►►► 54)
- 11 Fuel level

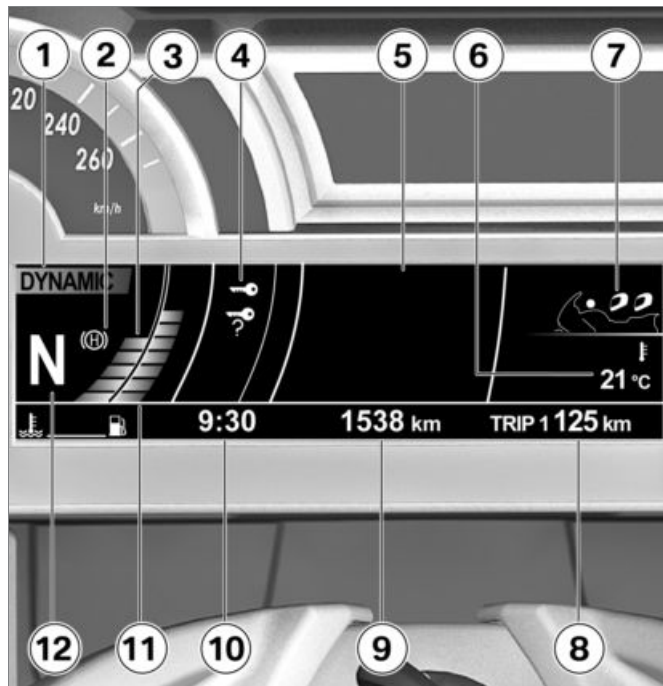

Meaning of symbols



Meanings of the symbols at position **1**:



Average fuel consumption since last reset (→ 56)



Current fuel consumption



Range with fuel now on board (→ 22)



Average speed since last reset (→ 56)



Ambient temperature (→ 22)



Tire inflation pressures (→ 23)



Stopwatch (→ 56)



Travel times (→ 56)



Date (display mode depends on the time format selected) (→ 54)



Electrical system voltage

 Oil level (→ 23)



- 2 Rear-seat heating ON
- 3 Heated handlebar grips switched on
- 4 Front-seat heating ON

– with Electronic Suspension Adjustment (ESA)^{OE}

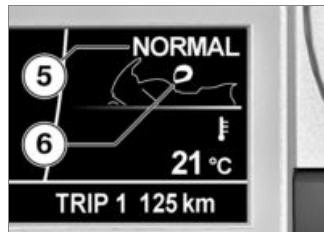

- 5 Damping
- 6 Vehicle load

Range

 The range indicates the travel distance available with the remaining fuel. The average consumption employed to calculate the remaining travel range does not appear in the display and may vary from the indicated average consumption. You must put at least five liters of fuel into the fuel tank for the new

level to be registered correctly. If the sensor cannot register the new level the range display cannot be updated.

If the motorcycle is standing on its side stand, the motorcycle's inclined position will prevent the fuel level from being registered accurately. For this reason travel range is only calculated with the side stand retracted.



NOTICE

The determined range is an approximate reading. BMW Motorrad therefore recommends that you do not try to use the full range before refueling. ◀

Ambient temperature



Engine heat can lead to spurious readings of ambient temperature when the motorcycle is stationary. When the

effects of engine heat on the monitored temperature become excessive the display responds by temporarily reverting to -- as the display reading.

 If the ambient temperature drops below 37 °F (3 °C), this warning of possible icing-up appears. The display automatically switches from any other mode to the temperature reading when the temperature drops below this threshold for the first time.

Tire inflation pressures

– with Tire Pressure Control (TPC/RDC)^{OE}

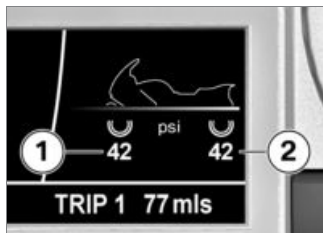

The displayed tire inflation pressures refer to a tire temperature of 68 °F (20 °C). The figure on the left side **1** indicates the front tire's inflation pressure, while the figure on the right **2** shows the inflation pressure in the rear tire. Immediately after switching on the ignition, "-- --" is displayed, as the transfer of the inflation pressure values does not begin until a speed of 19 mph (30 km/h) is exceeded for the first time.

If the pressure in a tire drops to a critical level, the corresponding display shows red.

 The tire warning symbol also appears on the display.

 The general warning light flashes red.

Additional information on the BMW Motorrad TPC/RDC is provided starting on page (➔ 108).

Oil level indicator

 The oil-level indicator gives you an indication of the engine oil level.

The conditions for the oil level indicator are as follows:

– Engine at operating temperature.

- Engine idling for at least ten seconds.
- Side stand retracted.
- Motorcycle is vertical.

The readings mean:

OK: Oil level correct.

CHECK !: Check oil level during next refueling stop.

- - -: No measurement possible (above-mentioned conditions not met).

Service display



If a service is due, for a brief period after the pre-ride check the service symbol appears on the display and the service-due date shows instead of the odometer reading.



If the service is overdue the General warning light briefly

shows yellow and the service symbol lights up continuously.



If the countdown to the next service is less than one month, service-due date **1** appears on the display.



If the vehicle covers high annual mileages then shorter service intervals may be required. If the countdown distance to the early service is less than 621 mls (1000 km), countdown distance **2** appears on the display.



NOTICE

If the service display appears more than a month before the service date, the current day's date must be reset in the instrument cluster. This situa-

tion can occur if the battery was disconnected.◀

Warning and indicator lights

- 1 ABS (►► 38)
- 2 DTC (►► 38)
- 3 Turn indicator, left
- 4 Fuel reserve (►► 34)
- 5 High-beam headlight
- 6 Turn indicator, right
- 7 Electronic engine management
- 8 – with anti-theft alarm system (DWA)^{OE}
DWA (►► 81)
- 9 – with additional LED headlight^{OE}
or
– with additional LED headlight^{OA}
Auxiliary headlight (►► 59)
- 10 Cruise control (►► 68)
- 11 Universal warning light, appears together with warning symbols in display panel (►► 27)

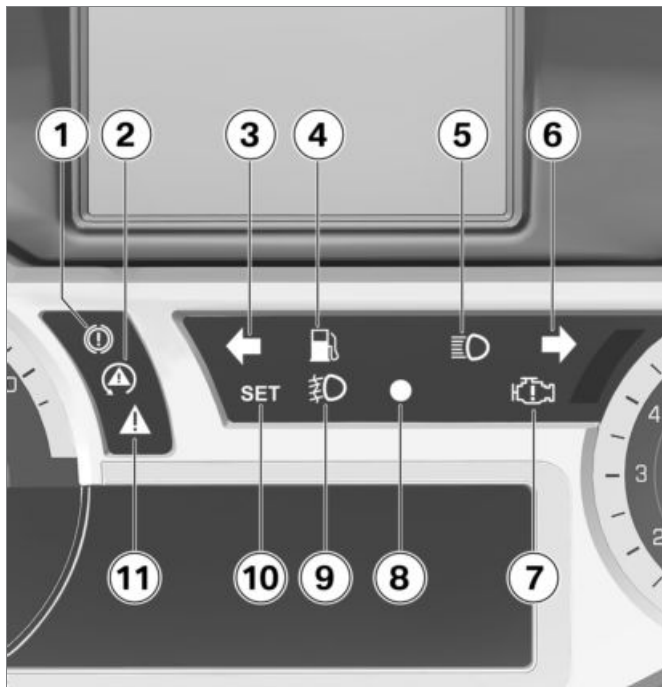

Warning lights

Display



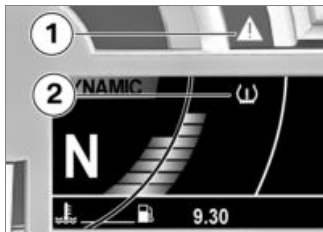





Warnings are displayed with the corresponding warning lamps.



Warnings for which there is no dedicated warning light are indicated by 'General' warning light **1** showing in combination with a warning symbol such as, for example, **2** appearing in the multifunction display. The universal warning lamp shows red or yellow, depending on the urgency of the warning.

Up to four warning symbols can be displayed at any given time. The universal warning lamp lights up for the most urgent warning. The possible warnings are listed on the following pages.













Overview of warning indicators

Warning and indicator lamps	Warning symbols in the display panel	Meaning
 Lights up yellow	 appears on the display	Electronic immobilizer is active (►►► 33)
 lights up yellow	ESA! is indicated	ESA error (►►► 33)
		Radio-operated key outside reception range (►►► 33)
		Replace battery of radio-operated key (►►► 33)
 Lights up	Fuel-level reading turns yellow	Fuel down to reserve (►►► 34)
 Lights up red	Temperature reading turns red	Coolant temperature too high (►►► 34)
 Lights up		Engine fault (►►► 34)
 Flashes		Severe engine fault (►►► 35)

Warning and indicator lamps

Warning symbols in the display panel









Meaning













	 appears on the display	Engine-oil level too low (►►► 35)
 Lights up red	 appears on the display	Battery charge current insufficient (►►► 35)
	 appears on the display	Onboard system voltage low (►►► 36)
 Lights up yellow	 appears on the display	Onboard system voltage critical (►►► 36)
 Lights up yellow	 appears on the display	Rear light failure (►►► 37)
 Lights up yellow	 appears on the display	Front light failure (►►► 37)
 Lights up yellow	 appears on the display	Light failure (►►► 37)
	 appears on the display	Outside temperature warning (►►► 37)

Warning and indicator lamps

Warning symbols in the display panel

Meaning

	Flashes		ABS self-diagnosis not completed (→ 38)
	Lights up		ABS error (→ 38)
	Flashes rapidly		DTC intervention (→ 38)
	Flashes slowly		DTC self-diagnosis not completed (→ 38)
	Lights up		DTC deactivated (→ 38)
	Lights up		DTC error (→ 39)
	Flashes red	 + tire pressure in red	Tire inflation pressure is outside approved range (→ 39)
		 + "--" or "-- --" is indicated	Transmission error (→ 39)

Warning and indicator lamps	Warning symbols in the display panel	Meaning
 Lights up yellow	 + "--" or "-- --" is indicated	Sensor defective or system fault (→ 40)
 Lights up yellow	 appears on the display	Battery of tire-inflation pressure sensor weak (→ 40)
 Lights up red	 appears on the display	Light direction of the low-beam headlight not known (→ 41)
 Flashes yellow	 appears on the display	Beam-throw adjustment of the low-beam headlight restricted (→ 41)
	 appears on the display	Headlight aiming changed (→ 41)
	 appears on the display	Anti-theft alarm battery low charge (→ 41)
 Lights up yellow	 appears on the display	Anti-theft alarm battery drained (→ 42)
	 appears on the display	Central locking locked (→ 42)

Electronic immobilizer is active



General warning light shows yellow.



Key appears on the display.

Possible cause:

The key being used is not authorized for starting, or communication between the key and engine electronics is disrupted.

- Remove other motorcycle keys from the ignition key ring.
- Use the reserve key.
- Have the defective key replaced, preferably by an authorized BMW Motorrad retailer.

ESA error



The general warning light lights up yellow.

ESA! is indicated.

Possible cause:

The ESA control unit has detected an error. Motorcycle damping is in this condition very firm and riding is rather uncomfortable - in particular on rough roads.

- Have the malfunction corrected as soon as possible at an authorized service facility, preferably an authorized BMW Motorrad retailer.

Radio-operated key outside reception range

– with Keyless Ride^{OE}



Indicator light "radio-operated key not within reception range" lights up.

Possible cause:

Communication between the radio-operated key and the engine electronics is disrupted.

- Check battery in radio-operated key.
- Use emergency key for further driving.
 - with Keyless Ride^{OE}
- Battery of radio-operated key is completely drained or radio-operated key has been lost (→ 49).
- Should the warning symbol appear while driving, keep calm. Driving can be continued; the engine will not switch off.
- Have the defective radio-operated key replaced by an authorized BMW Motorrad retailer.

Replace battery of radio-operated key

– with Keyless Ride^{OE}



The battery symbol is displayed.

WARNING

Unusual handling when engine is no emergency operating mode.

Accident hazard

- Adapt your style of riding accordingly.
- Avoid rapid acceleration and passing maneuvers.◀
- If you continue to drive, be prepared for unusual engine behavior (low power, poor response characteristics, abrupt stalling, etc.).
- Have the malfunction corrected as soon as possible at an authorized service facility, preferably an authorized BMW Motorrad Retailer.

Severe engine fault



The engine symbol flashes.

Possible cause:

The engine control unit has diagnosed a severe fault.

WARNING

Damage to the engine when it is in the emergency operating mode.

Accident hazard

- Adapt riding style: Ride slowly, avoid rapid acceleration and passing maneuvers.
- If possible, have the motorcycle picked up and the malfunction source eliminated by a specialized service facility, preferably an authorized BMW Motorrad Retailer.◀
- If you continue to ride be prepared for unusual engine behavior (low power, poor response, abrupt stalling, etc.).
- Have the malfunction corrected as soon as possible at an authorized service facility,

preferably an authorized BMW Motorrad retailer.

Engine-oil level too low



The oil can symbol is displayed.

Possible cause:

The electronic oil level sensor has detected a low engine oil level. Check the engine-oil level with the dipstick the next time you stop to refuel:

- Check engine oil level (▣▶ 124).
If oil level is too low:
- Topping up engine oil (▣▶ 126).

Battery charge current insufficient



General warning light shows red.



The battery symbol is displayed.

**WARNING****Failure of various motorcycle systems, such as lighting, engine or ABS, due to a discharged battery.**

Accident hazard

- Do not continue riding. ◀

The battery is not being charged. If you continue driving, the vehicle electronics will discharge the battery.

Possible cause:

Alternator or alternator drive defective.

- Have the malfunction corrected as soon as possible at an authorized workshop, preferably an authorized BMW Motorrad retailer.

Onboard system voltage low

The split battery symbol appears on the display.

Generator power is only just sufficient to supply all consumers and charge the battery.

Possible cause:

Too many consumers switched on. On-board system voltage tends to drop particularly at low engine rpm and when the engine is idling.

- When riding at low engine rpm switch off consumers that are not necessary for road safety (e.g. heated body warmer or auxiliary headlights).

Onboard system voltage critical

General warning light shows yellow.



The split battery symbol appears on the display.

Generator power is no longer sufficient to supply all consumers and charge the battery. In order to ensure that the engine can be started and the motorcycle ridden, the onboard electronics switch off the electricity supply to the onboard sockets and the auxiliary headlights. In extreme cases the seat heating and the grip heating might also be shut down.

Possible cause:

Too many consumers switched on. On-board system voltage tends to drop particularly at low engine rpm and when the engine is idling.

- When riding at low engine rpm switch off consumers that are not necessary for road safety (e.g. heated body warmer or auxiliary headlights).

Rear light failure



General warning light shows yellow.



Bulb symbol with arrow pointing to the rear appears on the display.

Possible cause:

Rear light, brake light or rear flashing turn indicator defective. The LED tail light must be replaced.

- Please contact a specialized workshop, preferably an authorized BMW Motorrad retailer.

Front light failure



General warning light shows yellow.



Bulb symbol with arrow pointing to the front appears on the display.

Possible cause:

Low-beam headlight, high-beam headlight, parking light or front flashing turn indicator defective. The low-beam headlight for one of the LED turn indicators must be replaced.

- Please contact a specialized workshop, preferably an authorized BMW Motorrad retailer.
- Replace bulb for high-beam headlight (➡ 141).

Light failure



General warning light shows yellow.



Bulb symbol with two arrows appears on the display.

Possible cause:

A combination of light failures has occurred.

- Please contact a specialized workshop, preferably an authorized BMW Motorrad retailer.

Outside temperature warning



The ice crystal symbol is displayed.

Possible cause:

The outside temperature measured at the vehicle is lower than 37 °F (3 °C).



WARNING

Danger of black ice even above 37 °F (3 °C), despite the lack of ice warning.

Risk of accident due to black ice.

- At a low outside temperature, icy conditions must be expected on bridges and in shady road areas. ◀
- Think well ahead when driving.

ABS self-diagnosis not completed



ABS warning light flashes.

Possible cause:

The self-diagnosis routine was not completed; the ABS function is not available. The motorcycle must reach a speed of at least 3.1 mph (5 km/h) before the ABS self-diagnosis routine can be completed.

- Ride off slowly. It must be noted that the ABS function is not available until the self-diagnosis has been completed.

ABS error



ABS warning light lights up.

Possible cause:

The ABS control unit has detected an error. The ABS function is not available.

- Continued driving is possible while taking the failed ABS function into account. Observe additional information on situations which can lead to an ABS error (→ 105).
- Have the malfunction corrected as soon as possible at an authorized workshop, preferably an authorized BMW Motorrad retailer.

DTC intervention



DTC warning light flashes rapidly.

The DTC has detected instability at the rear wheel and has reduced the torque. The warning light flashes longer than the DTC intervention lasts. This feature continues to furnish the rider with visual feedback confirming that the system has initiated active closed-loop intervention even after the critical situation has passed.

DTC self-diagnosis not completed



DTC warning light flashes slowly.

Possible cause:

The self-diagnosis was not completed; the DTC function is not available. The engine must be running and the motorcycle must be moved at a speed of at least 3.1 mph (5 km/h) in order for DTC self-diagnosis to complete.

- Ride off slowly. It must be noted that the DTC function is not available until the self-diagnosis has been completed.

DTC deactivated



DTC warning light lights up.

Possible cause:

The DTC system has been deactivated by the driver.

- Switch on DTC.

DTC error



DTC warning light lights up.

Possible cause:

The DTC control unit has detected an error. The DTC function is not available.

- It remains possible to continue riding. It must be noted that the DTC function is not available. Observe additional information on situations which can lead to a DTC error (→ 107).
- Have the malfunction corrected as soon as possible at an authorized workshop, preferably an authorized BMW Motorrad retailer.

Tire inflation pressure is outside approved range

– with Tire Pressure Control (TPC/RDC)^{OE}



General warning light flashes red.



+ the critical tire pressure shows red.

Possible cause:

The measured tire inflation pressure is outside the approved tolerance range.

- Check tire for damage and suitability for continued use. If it is still possible to drive with tire:



WARNING

Tire inflation pressure is outside approved range.

Poorer handling characteristic of the motorcycle.

- Adapt your style of riding accordingly.◀
- Correct tire inflation pressure at the next opportunity.



NOTICE

Before adjusting the tire inflation pressure, observe the information on temperature compensation and on inflation pressure adjustment in the chapter "Technology in detail".◀

- Have the tire checked for damage at an authorized service facility, preferably an authorized BMW Motorrad retailer.

If you are unsure about the tire's suitability for continued riding:

- Do not continue riding.
- Contact roadside service.

Transmission error

– with Tire Pressure Control (TPC/RDC)^{OE}



+ "---" or "-- ---" is indicated.

Possible cause:

There is a fault in the radio connection to the TPC/RDC sensors. Possible causes are radio systems in the surrounding area, which interfere with the connection between the TPC/RDC control unit and the sensors.

- Watch the TPC/RDC display in another environment. A continuous error is only present if the general warning lamp also lights up. In this case:
- Have fault eliminated at a specialist service facility, preferably an authorized BMW Motorrad retailer.

Sensor defective or system fault

– with Tire Pressure Control (TPC/RDC)^{OE}



General warning light shows yellow.



+ "---" or "--- ---" is indicated.

Possible cause:

Wheels without installed RDC sensors are mounted.

- Retrofit wheel set with RDC sensors.

Possible cause:

One or two TPC/RDC sensors have failed.

- Have fault eliminated at a specialist service facility, preferably an authorized BMW Motorrad retailer.

Possible cause:

A system fault has occurred.

- Have fault eliminated at a specialist service facility, preferably an authorized BMW Motorrad retailer.

Battery of tire-inflation pressure sensor weak

– with Tire Pressure Control (TPC/RDC)^{OE}



General warning light shows yellow.



The RDC battery symbol appears on the display.



NOTICE

This fault message is only shown for a short time immediately following the Pre-Ride-Check. ◀

Possible cause:

The battery for the tire inflation pressure sensor is no longer charged to full capacity. Operation of the tire inflation pressure control is only ensured for a limited time.

- Contact an authorized service facility, preferably an authorized BMW Motorrad retailer.

Light direction of the low-beam headlight not known



General warning light shows red.



Headlight with question mark appears on the display.

Illumination of the road ahead is no longer optimum; there is a possibility of dazzling oncoming traffic.

Possible cause:

Light direction and range of the low-beam headlight are unknown, adjustment is no longer possible.

- If it is dark leave the motorcycle where it is or have it picked up, if possible.
- Have the defect corrected as soon as possible by an authorized workshop, preferably an authorized BMW Motorrad retailer.

Beam-throw adjustment of the low-beam headlight restricted



General warning light flashes yellow.



Headlight with zero appears on the display.

Illumination of the road ahead is no longer optimum.

Possible cause:

Only restricted adjustment of light direction and range of the low-beam headlight possible.

- Have the defect rectified by a specialist workshop, preferably an authorized BMW Motorrad retailer.

Headlight aiming changed

– with adaptive headlight^{OE}



appears on the display. Cornering light control for the low-beam headlight is switched off.

Possible cause:

Headlight alignment has been changed from the as-delivered condition.

- Adjusting for traffic driving on right or driving on left (➡ 58).

Anti-theft alarm battery low charge

– with anti-theft alarm system (DWA)^{OE}



The anti-theft alarm battery symbol appears on the display.



NOTICE

This fault message is only shown for a short time immediately following the Pre-Ride-Check. ◀

Possible cause:

The anti-theft alarm battery no longer has its full capacity. The operation of the anti-theft alarm system is only ensured for a lim-

ited time with the vehicle battery disconnected.

- Contact an authorized service facility, preferably an authorized BMW Motorrad retailer.

Anti-theft alarm battery drained

– with anti-theft alarm system (DWA)^{OE}



General warning light shows yellow.



The anti-theft alarm battery symbol appears on the display.



NOTICE

This fault message is only shown for a short time immediately following the Pre-Ride-Check. ◀

Possible cause:

The anti-theft alarm system battery is completely discharged. Operation of the anti-theft alarm system is no longer ensured when the vehicle's battery is disconnected.

- Contact an authorized service facility, preferably an authorized BMW Motorrad dealer.

Central locking locked

– with central locking system^{OE}



The locked symbol appears on the display.

All locks in the central locking system are locked.

Service overdue



appears on the display.



General warning light briefly shows yellow after the pre-ride check.

Possible cause:

A necessary service has not been carried out.

- Have servicing carried out as quickly as possible by a specialist workshop, preferably an authorized BMW Motorrad retailer.

Operation

Steering and ignition lock	45	Windshield	67
Ignition	45	Wind deflection wing	67
Ignition with Keyless Ride	46	Cruise control	68
Multifunction display	51	Hill Start Control	70
Onboard computer	55	Storage compartments	71
Tripmeter	57	Clutch	71
Lights	57	Brakes	72
Turn indicators	60	Shifting	72
Hazard warning flashers	60	Mirrors	73
Emergency ON/OFF switch	61	Spring preload	73
Heated handlebar grips	61	Damping	74
Seat heating	62	ESA Electronic Suspension Adjust- ment	75
Dynamic Traction Control (DTC)	64	Central locking system	76
Riding mode	64	Alarm system(DWA)	80
Seat	66		

Tires 84

Steering and ignition lock

Keys

You are provided with 2 ignition keys. Should you lose your keys, refer to the information regarding the electronic immobilizer (EWS) (► 46).

Steering and ignition lock, tank filler cap lock, stowage compartment, seat lock, cases and top-case are all operated with the same vehicle key.

Lock handlebars



ATTENTION

Incorrect steering angle when the motorcycle is parked on the side stands.

Component damage cause by tipping over.

- On level ground, always turn the handlebars to the left to set the steering lock.

- Otherwise the angle of the ground determines whether the handlebars are set to the left or right. ◀
- Turn handlebars to full left or right lock position.



- Turn key to position **1** while moving handlebars slightly.
 - » Ignition, lights and all electrical circuits switched off.
 - » Handlebars locked.
 - » Key can now be removed.

Ignition

Switching on ignition



- Turn key to position **1**.
 - » Parking lamps and all function circuits switched on.
 - » Engine can be started.
 - » Pre-Ride Check in progress. (► 91)
 - » ABS self-diagnosis in progress. (► 91)
 - » DTC self-diagnosis is performed. (► 92)

Switching off ignition



- Turn key to position **1**.
- » Light switched off.
- » Handlebars not locked.
- » Key can now be removed.
- » The windscreen automatically moves to the bottom limit position.

EWS Electronic immobilizer

The motorcycle's electronic circuitry monitors the data stored in the ignition key through a ring antenna incorporated in the ignition lock. The engine manage-

ment system does not enable engine starting until the vehicle key has been recognized as "authorized" for your motorcycle.

NOTICE

A further key attached to the same ring as the ignition key used to start the engine could "irritate" the electronics, in which case the enabling signal for starting is not issued. The EWS warning is shown in the multifunction display. Always store further vehicle keys separately from the ignition key. ◀

If you lose an ignition key, you can have it disabled by your BMW Motorrad partner. When having a key disabled you should also bring all of the motorcycle's remaining keys with you. The engine can no longer be started using a disabled vehicle

key; however, a disabled vehicle key can be enabled again. Emergency and spare keys are only available through an authorized BMW Motorrad retailer. The keys are part of an integrated security system, so the retailer is under an obligation to check the legitimacy of all applications for replacement/extra vehicle keys.

Ignition with Keyless Ride

– with Keyless Ride^{OE}

Vehicle keys

You are provided with one radio-operated key and one emergency key. Should you lose your keys, refer to the information regarding the electronic immobilizer (EWS) (▶▶ 46).

The ignition, tank filler cap, central locking and anti-theft alarm system are controlled with the

radio-operated key. The seat lock, storage compartments, Topcase and case can be operated manually.

NOTICE

When the range of the radio-operated key is exceeded (e.g. in case or Topcase), the motorcycle cannot be started and the central locking system cannot be locked/unlocked.

If the range is exceeded, the ignition is switched off after approx. 1.5 minutes and the central locking system is **not** locked.

It is advisable to carry the radio-operated key directly on your person (e.g. in a jacket pocket) and to also carry the emergency key as an alternative.◀



Range of Keyless Ride radio-operated key

Approx. 3.3 ft (Approx. 1 m)

Locking handlebars

Turn handlebars to left or right. Radio-operated key is within reception range.

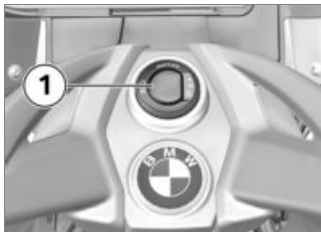

ATTENTION

Incorrect steering angle when the motorcycle is parked on the side stands.

Component damage cause by tipping over.

- On level ground, always turn the handlebars to the left to set the steering lock.

- Otherwise the angle of the ground determines whether the handlebars are set to the left or right.◀

- Press and hold button **1**.
 - » Steering lock audibly locks.
 - » Ignition, lights and all electrical circuits switched off.
- To unlock the steering lock, briefly press the button **1**.

Switch on ignition

Radio-operated key is within reception range.

- The ignition can be activated in two ways:



• **Version 1**

- Briefly press button **1**.
- » Parking lamps and all function circuits switched on.
- » Engine can be started.
- » Pre-Ride Check in progress. (▶▶▶ 91)
- » ABS self-diagnosis in progress. (▶▶▶ 91)
- » DTC self-diagnosis is performed. (▶▶▶ 92)

• **Version 2**

- Steering lock is locked, press and hold button **1**.
- » Steering lock is unlocked.

- » Parking lamps and all function circuits switched on.
- » Engine can be started.
- » Pre-Ride Check in progress. (▶▶▶ 91)
- » ABS self-diagnosis in progress. (▶▶▶ 91)
- » DTC self-diagnosis is performed. (▶▶▶ 92)

Switch off ignition

Radio-operated key is within reception range.

- The ignition can be deactivated in two ways:

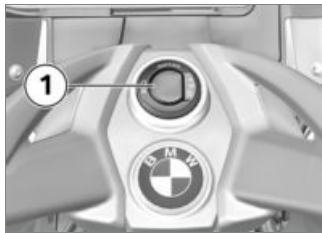

• **Version 1**

- Briefly press button **1**.
- » Light is switched off.
- » Handlebars are not locked.
- » The windshield automatically moves to the bottom limit position.

• **Version 2**

- Turn handlebars to full left or right lock position.
- Press and hold button **1**.
- » Light is switched off.
- » Steering lock is locked.
- » The windshield automatically moves to the bottom limit position.

EWS Electronic immobilizer

The motorcycle's electronic circuitry monitors the data stored in the radio-operated key through a ring antenna incorporated in the radio lock. The engine management system does not enable engine starting until the radio-operated key has been recognized

as "authorized" for your motorcycle.

NOTICE

A further key attached to the same ring as the ignition key used to start the engine could "irritate" the electronics, in which case the enabling signal for starting is not issued. The EWS warning is shown in the multifunction display.

Always store further vehicle keys separately from the ignition key. ◀

If you lose a radio-operated key, you can have it disabled by your authorized BMW Motorrad retailer. When having a key disabled you should also bring all of the motorcycle's remaining keys with you.

The engine can no longer be started using a disabled radio-operated key; however, a dis-

abled radio-operated key can be enabled again.

Emergency and spare keys are only available through an authorized BMW Motorrad retailer. As the radio-operated keys are part of an integrated security system, the retailer is under an obligation to check your legitimacy.

Battery of radio-operated key is completely drained or radio-operated key has been lost

NOTICE

The antenna is located in front of the tank filler cap or under the tank cover. ◀

- Should you lose your keys, refer to the information regarding the electronic immobilizer (EWS).
- Should you lose the radio-operated key while driving, the

vehicle can be started using the emergency key.

- If the battery of the radio-operated key is completely drained, the motorcycle can be started by touching the tank cover with the radio-operated key.



- Hold emergency key **1** or completely drained radio-operated key **2** on tank cover over antenna **3**.



Period in which the engine must be started. Then unlocking must be repeated.

30 s

- » Pre-Ride Check in progress.
- Key has been detected.
- Engine can be started.
- Starting the engine (▶▶▶ 90).

Replace battery of radio-operated key

If the radio-operated key fails to react when the button is pressed briefly or is pressed and held:

- The battery of the radio-operated key no longer has its full charging capacity.
- » Replace battery.



The battery symbol is displayed.

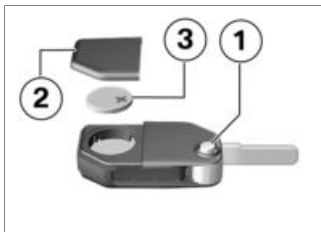

- Press button **1**.
- » Key bit folds open.
- Press battery cover **2** upward.
- Remove battery **3**.
- Dispose of the old battery in accordance with legal regulations. Do not dispose of the battery in the household waste.



ATTENTION

Unsuitable of improperly inserted batteries.

Component damage

- Use a battery compliant with the manufacturer's specifications.

- When inserting the battery, make sure that the polarity is correct. ◀
- Insert the new battery with the positive side up.



Battery type

for Keyless Ride radio-operated key

CR 2032

- Install seal **1** and battery cover **2**.
- » Red LED in instrument cluster flashes.
- » The remote-control is again ready to be used.

Multifunction display

Selecting menu



Press button **2** to step through the sequence of menus, starting with the **Info** menu. Each time you press button **2** you call up the next menu in the sequence; the number of menus depends on the options fitted to the motorcycle.

You also have the option of pressing button **3** for direct access to a favorite menu of your choice.

With the exception of the **Au-**
dio area, the **Settings**
menu can only be called with the
motorcycle at a standstill.

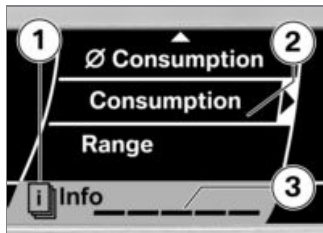

The type of menu shows at position **1**; cursor **2** indicates the current selection. Each line **3** indicates a menu that can be selected. The line representing the menu you are currently viewing is grayed to show where you are in the sequence of menus.



NOTICE

A list of all the menus can be found in the separate Quick Reference Guide. ◀

Selecting menu item



Move the cursor within the menu using the Multi-Controller **1**.

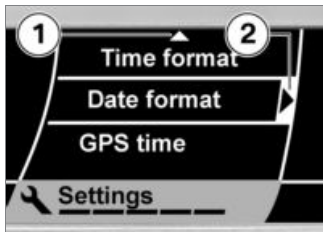

An arrow **1** on the upper or lower edge of the display indicates that by turning the Multi-Controller in the corresponding direction, you can access additional menu items. If the arrow **2** is displayed on the cursor, then you can call up a submenu by pressing the Multi-Controller to the right. See (▶▶ 52) for the different meanings of average values and the list selection.

Setting parameters



Direct selection:

If you move the cursor to a menu item that requires no other settings, your selection goes active right away.

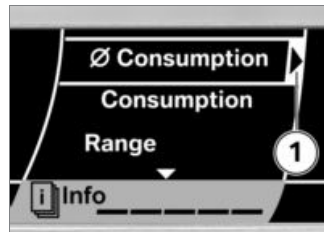

Resetting values:

You can reset average values marked with an arrow **1** by long-pressing the Multi-Controller to the right.

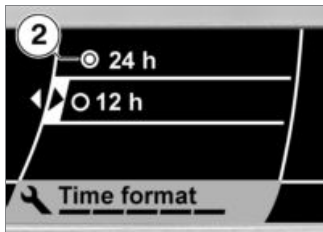

Selecting from a list:

A circle **2** beside each selectable item means that the items are part of a selection list. A circle with a dot indicates the item that is currently selected.

If you want to change the selection, move the cursor to another item in the list and press the Multi-Controller to the right to either activate or deactivate the parameter you selected.



Setting numerical values:

If there are one or more numerical values between the arrows **3**, you can increase the values by turning the Multi-Controller up or reduce the values by turning it down. By pressing the Multi-Controller to the right or left, you can change between the values.



Setting relative values:

A bar indicator enables you to set a value in a range between two limits. Turning the Multi-Controller up increases or turning it down decreases the value to be set.

Exiting menu

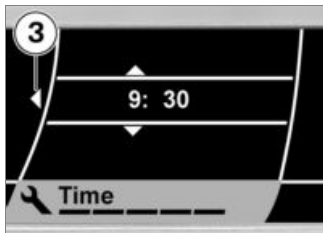

Arrow **3** appears when you are in a submenu.



By pressing the Multi-Controller **1** to the left, you jump back to the next-higher menu; by pressing the MENU button **2**, you jump back to the main menu.

To hide the menus, press the Multi-Controller **1** to the left in a main menu.

Selecting favorite menu

- Select the main menu of your choice.



- Hold down button **3**.
- ◊ The diamond appears to the right of the menu designation.

» The menu you have selected will subsequently be called up whenever you press button **3**.

Adapting mode of presentation

- Switch on ignition.
- Call up the Settings menu and select User.

The settings you can choose are as follows:

- Language: Display language (German, English, Spanish, Italian, French, Dutch, Portuguese)
- Time format - 12 h / 24 h: Clock in 12-hour format (12 h) or in 24-hour format (24 h)
- Time format - Date format: Date in day . month . year format (dd . mm . yy) or in month / day / year format (mm / dd / yy)
- Time format - GPS time: Accept GPS time and GPS date from the built-in navigation system (On), (Off)
- Brightness: Brightness of the display and the instruments
- Start logo: Show start logo after the ignition is switched on (On), (Off)
- Background: Indicator on the display when the radio is

switched off: Empty: no indicator, Logo: 6 cylinder logo, Speedo: digital speed indicator

- Fact. settings: Restore factory defaults (when Reset! appears on the display, press the Multi-Controller to the right and hold it in this position)
- Using the Multi-Controller, make the desired adjustments.

Onboard computer

Selecting display readings

- Call up the Info menu and select the item of information of your choice.

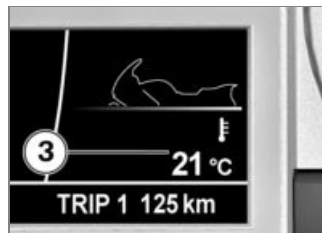

The following items of information can be displayed in panel 3:

- ØConsump.: average fuel consumption
- Consump.: current fuel consumption
- Range: Range with fuel remaining in fuel tank
- ØSpeed: Average speed
- Temperature: Ambient temperature
- Tire pressure: Tire pressures
- Stopwatch: Stopwatch
- Travel times: Travel times

- Date: Current date
- Oil level: Engine-oil level
- Off: No reading

Resetting average data

- Call up the Info menu and select the average value you want to reset.
- Push the Multi-Controller to the right and hold it in this position until the average value is reset.

Operating stopwatch

- Call up the Info menu and select Stopwatch.





- With the stopwatch stopped, push the Multi-Controller **1** to the right to start the stopwatch.
 - » The stopwatch continues timing even if you select some other reading or switch off the ignition.
- With the stopwatch running, push Multi-Controller **1** to the right to stop the stopwatch.
- Push Multi-Controller **1** to the right and hold it in this position to reset the stopwatch.

Measuring travel times

- Call up the Info menu and select Travel times.



- Push the Multi-Controller **1** to the right and hold it in this position to reset the travel time.
 - » Timing continues even if you select some other reading or switch off the ignition.
-  Total driving time since the vehicle was last reset.
-  Immobilization period since the vehicle was last reset.

Tripmeter

Selecting tripmeter

- Switch on ignition.



- Open Trip menu by pressing button **1** and then select the desired tripmeter **2**.

The following counters can be displayed:

- Tripmeter 1 (Trip 1)
- Tripmeter 2 (Trip 2)
- Automatic tripmeter (Trip Auto) resets automatically eight hours after the ignition is switched off.

Reset tripmeter

- Switch on ignition.
- Select desired tripmeter.



- Press Multi-Controller **1** to right and hold until tripmeter **2** has been reset.

Lights

Parking lights

The parking lights come on automatically when the ignition is switched on.



NOTICE

The parking lights are a strain on the battery. Do not leave the ignition switched on longer than absolutely necessary. ◀

Headlight low beam

The headlights automatically come on in their low-beam mode as soon as you start the engine.

Headlight high beam and flasher



- Press switch **1** toward front to switch on high beams.

- Pull switch **1** rearward to operate headlight flasher.

NOTICE

The high-beam headlight can also be switched on when the engine is not running. ◀

Parking light

- Switch off ignition.

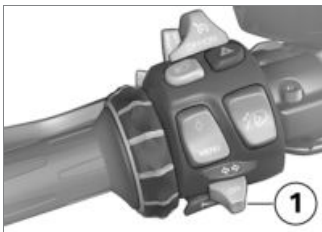

- Immediately after switching off the ignition push the button **1** to the left and maintain pressure until the parking lights come on.

- Switch ignition on and then off again to switch off parking lights.

Adjusting for traffic driving on right or driving on left

– with adaptive headlight^{OE}

- Switch on ignition.
- Call up the Settings menu and select Vehicle - Headlight.



- R-hand traffic: for countries in which the traffic

drives on the right-hand side of the road.

- L-hand traffic: for countries in which the traffic drives on the left-hand side of the road.

- Select the appropriate setting.



appears on the display.

- » The cornering light function is not active for as long as the setting is changed.

Headlight range

The xenon headlight has continuous beam throw control that keeps beam throw constant regardless of how the motorcycle is ridden and the load it carries.

Operating auxiliary headlight

- with additional LED headlight^{OE}
- or
- with additional LED headlight^{OA}



NOTICE

The auxiliary headlights are approved for use as fog lights and may only be used in poor weather conditions. Comply with the country-specific road traffic regulations. ◀



- Press button **1** to switch on the auxiliary headlights.



The telltale light shows.



If this warning symbol appears it tells you that the onboard system voltage is low. If applicable, the auxiliary headlights might have been temporarily switched off.

- Press button **1** again to switch off the auxiliary headlights.

Operating ground lighting

– with ground lighting^{OA}

- Switch on ignition.
- Call up the Settings menu and select Vehicle - Ground light.

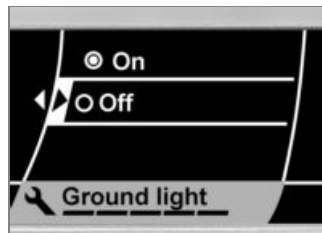

- On: Ground lighting comes on for a brief period after the ignition is switched off.
- Off: Ground lighting does not come on after the ignition is switched off.

- with central locking system^{OE}
- » If the function is switched off as described above, the ground lighting switches on nonetheless when you unlock the central locking system.<

Turn indicators

Operating turn indicators

- Switch on the ignition.

NOTICE

The turn indicators automatically switch off when the defined driving time and distance have been reached. The defined riding time and distance can be set by an authorized BMW Motorrad retailer.<

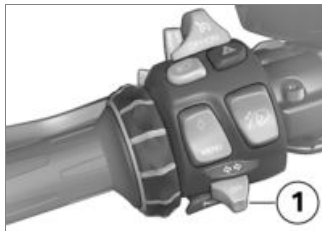

- Press button **1** to left to switch on left-side turn indicators.
- Press button **1** to right to switch on right-side turn indicators.
- Press button **1** into center position to switch off turn indicators.

Hazard warning flashers

Operating hazard warning flashers

- Switch on ignition.

NOTICE

The hazard warning flashers place a strain on the battery. Do not use the hazard warning flashers for longer than absolutely necessary.<

NOTICE

If a turn indicator button is pressed with the emergency flashing function switched on, the flashing function replaces the emergency flashing function as long as the button is pressed. If the turn indicator button is released, the emergency flasher function becomes active again.<



- Press button **1** to switch on hazard warning flashers.
» Ignition can be switched off.
To switch off the hazard warning flashers:
 - Switch on the ignition and press button **1**.

Emergency ON/OFF switch



- 1** Emergency ON/OFF switch



WARNING

Operation of the emergency ON/OFF switch when riding.

Danger of falling due to blocking of rear wheel.

- Do not operate the emergency ON/OFF switch when riding.◀

The engine can be switched off easily and quickly using the emergency ON/OFF switch.



- a** Engine switched off
b Operating position

Heated handlebar grips

Operate the heated handlebar grips

- Start engine.

NOTICE

The heated grips option can only be activated when the engine is running. ◀

- Call up the **Handle heat.** menu.



The grips have five-stage heating. Stage five is for heating the grips quickly: it is advisable to switch back to a lower stage as soon as the grips are warm.

- Select the desired heating level.



Symbol **1** appears on the display, indicating that the handlebar grip heating is ON.



If this warning symbol appears it tells you that the onboard system voltage is low. If applicable, the handlebar grip heating might have been temporarily switched off.

Seat heating

Rider's seat heater

- Start engine.

NOTICE

Seat heating can be activated only when the engine is running. ◀

- Call up the **Seat heating** menu.

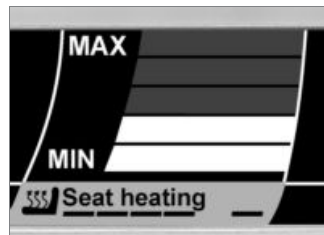

The rider's seat has five-stage heating. Stage five is for heating the seat quickly: it is advisable to switch back to a lower stage as soon as the seat is warm.

- Select the desired heating level.



Symbol **1** appears on the display, indicating that the seat heating is ON.

 If this warning symbol appears it tells you that the onboard system voltage is low. If applicable, the seat heating might have been temporarily switched off.

Passenger seat heater

- Start engine.

NOTICE

Seat heating can be activated only when the engine is running. ◀

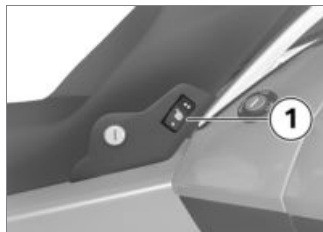

- Select desired heating level with switch **1**.



The passenger seat can be heated at two levels. The second level is used for fast heat-up of the seat; then the switch should be switched back to the first level.

- **2** Switch in middle position: Heating off.
- **3** Switch in one-dot position: 50 % heating output.
- **4** Switch in two-dot position: 100 % heating output.



Symbol **1** appears on the display, indicating that the rear seat heating is ON.



If this warning symbol appears it tells you that the onboard system voltage is low. If applicable, the seat heating might have been temporarily switched off.

Dynamic Traction Control (DTC)

Switching DTC off and on

- Switch on ignition.
- Call up the Settings menu and select DTC.



NOTICE

This menu cannot be called up while the motorcycle is on the move. ◀



- Select *Off (once)* to switch DTC off once, in other

words until the ignition is next switched on.



The DTC warning light shows to indicate that DTC has been switched off.

- Select *On* to switch on DTC. Alternate method: Switch the ignition off and then on.



DTC warning light goes out; if self-diagnosis has not completed the DTC warning light starts flashing.

Riding mode

Setting driving mode

- Switch on ignition.



- Press button **1**.

NOTICE

Details on the selectable driving modes are provided in the chapter "Technology in Detail". ◀



The current setting is shown at position **2**; each time the button is pressed one of the possible riding modes is shown at position **3**.

- Repeatedly press the button until the reading shows the riding mode you want.
 - » With the motorcycle at a standstill, the mode you select is activated after a brief delay.
 - » The new driving mode is activated while driving under the following conditions:
 - Brake not actuated

- Throttle turned all the way back
- Clutch actuated
 - » Once the new riding mode has been activated, the selection display disappears.
 - » The mode selected in this way is retained with the engine-characteristic and DTC adaptation settings even after the ignition has been switched off.

Seat

Remove the seat



- Use the ignition key to unlock seat lock **1** and lift the rear of the seat.

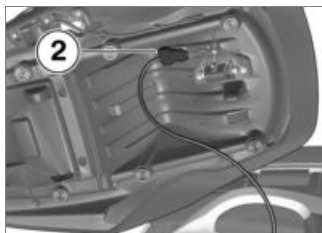

- Disconnect plug **2** of the seat heating and remove the seat.
- Place the seat, upholstered side down, on a clean surface.

Installing seat

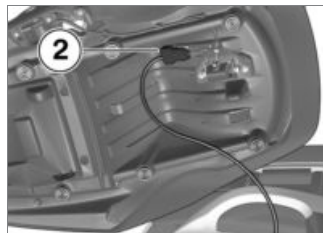

- Connect plug **2** of the seat heating.

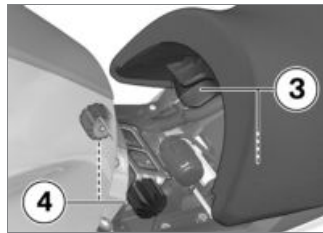

- Position the seat with mounts **3** in rubber buffers **4** on left and right.

- Lower the rear of the seat and engage the seat in the latching mechanism.

Windshield

Adjusting windshield

- Switch on the ignition.
- » When you pull away the windshield automatically returns to the position it was in before the ignition was switched off.



- Press button **1** at top to raise windshield.
- Press button **1** at bottom to lower windshield.

- Switch off ignition.
- » The windshield automatically moves to the bottom limit position.
- » If the windscreen encounters resistance before it reaches its limit position the pressure-sensitive finger guard system goes active. The windscreen is stopped and raised slightly. After a delay of a few seconds the windscreen again attempts to move to the bottom limit position.

There is no guarantee that the pressure-sensitive finger guard system will function correctly if a windscreen that does not have BMW approval is installed.

- Under these circumstances: Before switching off the ignition, check that there is nothing obstructing the windshield.

Wind deflection wing

Adjusting slipstream deflectors



WARNING

Adjusting the slipstream deflectors while driving.

Accident hazard

- Do not attempt to adjust the slipstream deflectors unless the motorcycle is at a standstill. ◀
- Turn slipstream deflector **1** in or out to adjust the airflow for the rider. In this process, note the outer limit stop.

Cruise control

Switching on cruise control



- Push switch **1** to right.
- » Button **2** is operational.

Setting road speed



- Briefly press button **2** forward.

NOTICE

The cruise control can be set within a speed range from 19 mph (30 km/h) to 136 mph (220 km/h).◀

SET Indicator light for cruise-control system lights up.

- » The motorcycle maintains your current cruising speed and the setting is saved.

Acceleration



- Briefly press button **2** forward.
- » Speed is increased by 0.6 mph (1 km/h) each time button is pressed.
- Press button **2** forward and hold.
- » The motorcycle accelerates steplessly.
- » If the button **2** is no longer pressed, the speed achieved is maintained and saved.

Decreasing speed



- Briefly press button **2** backward.
 - » Speed is decreased by 0.6 mph (1 km/h) each time button is pressed.
- Press button **2** back and hold.
 - » The motorcycle decelerates steplessly.
 - » If the button **2** is no longer pressed, the speed achieved is maintained and saved.

Deactivate cruise control

- Actuate brakes, clutch or throttle grip (take back throttle be-

yond back position) to deactivate cruise-control system.

- » Cruise control indicator lamp goes out.

Resuming former cruising speed



- Briefly push button **2** back to return to the speed saved beforehand.

NOTICE

Opening the throttle does not deactivate the cruise-control system. If you release the throttle grip, the motorcycle will decel-

erate only to the cruising speed saved in memory, even though you might have intended slowing to a lower speed.◀

SET Indicator light for cruise-control system lights up.

Switching off cruise control



- Push switch **1** to left.
 - » The system is deactivated.
 - » Button **2** is locked.

Hill Start Control

– with Hill Start Control^{OE}

Hill Start Control Operating

ATTENTION

Switching off the engine or ignition, folding out the side stands, timeout (approx. 20 minutes) or in the event of a fault.

Drive-off assistant brake failure.

- It is imperative to secure the motorcycle by manual braking.◀

NOTICE

Hill Start Control is only a convenience system for easier hill-starting and should, therefore, not be confused with a parking brake.◀

NOTICE

You can find more detailed information regarding Hill Start Control in the "Technology in detail" chapter.◀

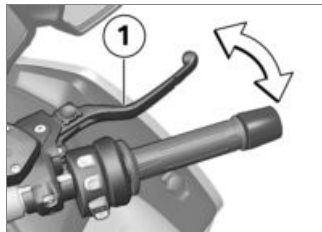

- Apply brake lever **1** firmly and then release.

 The indicator lamp for Hill Start Control appears on the display.

- » Hill Start Control has been activated.
- To switch off Hill Start Control, pull brake lever **1** again.

NOTICE

Hill Start Control is automatically deactivated after pulling away.◀

- The general warning light and the indicator lamp on the display light up briefly and then the two Hill Start Control indicator lamps go out when the brake is fully released.
- » Hill Start Control is now switched off.

Storage compartments

Use the storage compartments



- Use the ignition key to open or close lock **1** of the left storage compartment or lock **2** of the right storage compartment.
- To open the lid, push the unlocked lock barrel down.



ATTENTION

High temperatures in the storage compartments, particularly in summer.

Damage to objects housed here, particularly electronic devices such as cell phones and MP3 players.

- Refer to the operating instructions of the electronic device for possible usage restrictions.◀
- In summer, do not place heat-sensitive objects in the storage compartments.

Clutch

Adjusting clutch lever



WARNING

Modified position of the clutch-fluid reservoir.

Air in the clutch system.

- Do not turn the handlebar fitting on the handlebar.◀



WARNING

Adjusting the clutch lever while driving.

Accident hazard

- Only adjust the clutch lever when the motorcycle is stationary.◀



- Turn adjusting screw **1** clockwise to increase distance between clutch lever and handlebar grip.
- Turn adjusting screw **1** counterclockwise to decrease distance between clutch lever and handlebar grip.

NOTICE

The adjusting screw can be turned more easily if you press the clutch lever forward when doing so. ◀

Brakes

Adjusting handbrake lever

WARNING

Modified position of the brake-fluid reservoir.

Air in the brake system.

- Do not turn the handlebar fitting on the handlebar. ◀

WARNING

Adjusting the brake lever while driving.

Accident hazard

- Only adjust the brake lever when the motorcycle is stationary. ◀



- Turn adjusting screw **1** clockwise to increase distance between brake lever and handlebar grip.
- Turn adjusting screw **1** counterclockwise to decrease distance between brake lever and handlebar grip.

NOTICE

The adjusting screw can be turned more easily if you push the brake lever forward when doing so. ◀

Shifting

Adjusting shift lever



- Slacken screw **1**.
- Turn foot piece **2** into desired position.

NOTICE

A foot piece adjusted too high or too low can cause problems when shifting. In case of shifting problems, check the adjustment of the foot piece. ◀

- Tighten screw **1** to appropriate torque.

 Eccentric, peg to shift lever

6 lb/ft (8 Nm)

Mirrors

Adjusting mirrors



- Move mirror into desired position by applying light pressure at edge.

Spring preload Setting

It is essential to set the spring preload to suit the load carried by the motorcycle. Increase spring preload when the vehicle is heavily loaded and reduce spring preload accordingly when the vehicle is lightly loaded.

Adjusting spring preload at rear wheel

- Make sure ground is level and firm and park motorcycle.



WARNING

Adjusting the spring preload while riding.

Accident hazard

- Adjust the spring preload only when the motorcycle is stationary. ◀
- Pull out adjustment wheel **1** for better accessibility.

WARNING

Uncoordinated settings of spring preload and spring strut damping.

Poorer handling.

- Adjust damping characteristic to changed spring preload. ◀
- To increase spring preload, turn adjustment wheel in direction of HIGH arrow.
- To decrease spring preload, turn adjustment wheel in direction of LOW arrow.



Basic setting of spring preload, rear

– without Electronic Suspension Adjustment (ESA)^{OE}

Knob turned as far as it will go in the direction indicated by the LOW arrow (Full tank of gas, with rider 187 lbs (85 kg)) ◀

- Push the adjustment wheel back in to its original position.

Damping Setting

The damping must be adjusted to the road conditions and the spring preload.

- A rough road surface requires softer damping than a smooth road surface.
- An increase in spring preload requires firmer damping, a reduction in spring preload requires softer damping.

Adjust damping on rear wheel

- Make sure ground is level and firm and park motorcycle.



- If you want a harder damping characteristic, use the tool from the onboard toolkit to turn adjusting screw **1** in the direction indicated by the H arrow.
- If you want a softer damping characteristic, use the tool from the onboard toolkit to turn adjusting screw **1** in the direction indicated by the S arrow.



Basic setting of rear wheel rear-wheel damping

– without Electronic Suspension Adjustment (ESA)^{OE}

Turn the adjusting screw as far as it will go in the direction indicated by the H arrow and then turn it back one and a half turns in the direction indicated by the S arrow (Full tank of gas, with rider 187 lbs (85 kg))◀

ESA Electronic Suspension Adjustment

– with Electronic Suspension Adjustment (ESA)^{OE}

Settings

You can use the ESA Electronic Suspension Adjustment feature to adapt your motorcycle to its current load as well as the road surface. This entails selecting the load variant and the required damping action.

You have a choice of three load variants with any of three damping characteristics selectable for each one.

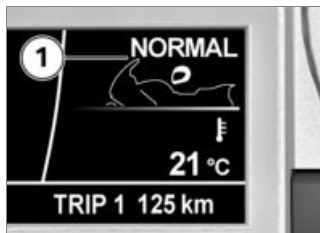

The current setting appears in display field **1**.

Additional information on the ESA II Electronic Suspension Adjustment is provided on page (▶▶▶ 109).

Adjusting the suspension

- Start engine.



NOTICE

The damping cannot be adjusted while the motorcycle is being ridden.◀

- Call up the ESA menu.

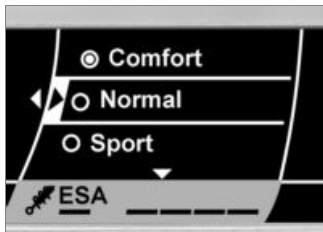

The possible settings for the damping characteristic appear on the display.

- Comfort: comfort mode
- Normal: normal mode
- Sport: sport mode
- Select the damping characteristic you want or move the cursor down to set the vehicle load.



NOTICE

The load setting cannot be adjusted while the motorcycle is underway. ◀



The possible settings for vehicle load appear on the display.



One-up



One-up with luggage



Two-up (with luggage)

- Select the vehicle load variant you want.
- » The suspension adjusts to suit the new setting and the ESA reading changes accordingly. The symbols for vehicle load and damping characteristic are

grayed while adjustment is in progress.

Central locking system

Locking

- with central locking system^{OE}



- Switch on ignition and press button **1**.



NOTICE

Only motorcycles without Keyless Ride have a separate remote key for the central locking system and alarm system. ◀

- Alternatively: Press button **2** on remote control or radio-operated key.
- » The two stowage compartments in the side panels, the cases and the topcase are locked.
- » These locks cannot subsequently be unlocked manually.

 The locked symbol appears on the display.

- with anti-theft alarm system (DWA)^{OE}
- » The functionality and operation of the remote control of the alarm system are described in the corresponding section.<

Unlocking

- with central locking system^{OE}



- Switch on the ignition and press button **1**.
- Alternatively: Press button **2** on remote control or radio-operated key.
- » The two stowage compartments in the side panels, the cases and the topcase are unlocked.
- » Once a lock has been locked manually it subsequently has to be unlocked manually as well.
- with anti-theft alarm system (DWA)^{OE}
- » The functionality and operation of the remote control of the

- alarm system are described in the corresponding section.<
- with ground lighting^{OA}
- » The ground lighting is switched on for a brief period.<

Emergency unlocking

- with central locking system^{OE}

If the central locking system refuses to unlock, you can open the cases, topcase and stowage compartments manually. The procedure is as follows:

- Removing case (➡ 117).
- Opening case (➡ 116).



- First turn the key in the top-case lock 45° past the LOCK position, then turn it to the dot position and press in the lock barrel.
- » The release lever pops open.



- Turn the key in the storage-compartment lock 45° out past the vertical position and press in the lock barrel.
- » The storage-compartment lid pops open.

Logon of remote controls

- with central locking system^{OE}
- with anti-theft alarm system (DWA)^{OE}
- without Keyless Ride^{OE}

If a remote control has been mislaid and a replacement acquired or if you are going to use an additional remote control, you must

invariably log on all the remote controls in the set.

- Enable logon of the remote controls as follows:
- Switch on the ignition.

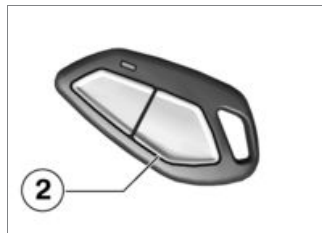

- Press button **2** on the remote control three times.
- » One acoustic signal sounds.
- Within ten seconds, switch off the ignition.
- Press button **2** on the remote control three times.
- » One acoustic signal sounds.
- Within ten seconds, switch on the ignition.

You can now proceed to log on all the remote controls.

- Step through the following procedure with each remote control in turn:

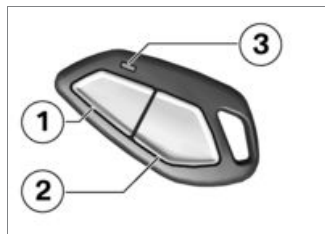

- Press and hold down buttons **1** and **2** until LED **3** stops flashing.
 - » LED **3** flashes for about ten seconds.
- Release buttons **1** and **2**.
 - » LED **3** is illuminated.
- Press button **1** or button **2**.
 - » One acoustic signal sounds, LED **3** goes out.

To complete logon:

- Switch off ignition.
 - » Three acoustic signals sound.
 - » Logon is also ended when
 - four remote controls have been logged on.
 - if you have logged on the first remote control and then do not press a button within approximately 30 seconds.

Synchronizing the remote-control units

- with central locking system^{OE}
- with anti-theft alarm system (DWA)^{OE}
- without Keyless Ride^{OE}

If the central locking system stops responding to the signals from a remote control unit then the unit will need to be resynchronized. This scenario can arise (for example) after the remote-control unit's buttons have been pressed frequently

while the unit was beyond the range of the alarm system.

- The procedure for synchronizing the remote controls is as follows:
 - Switch on the ignition.

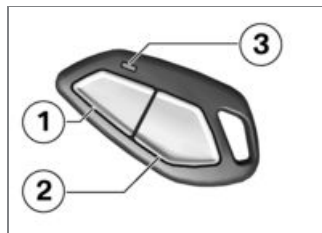

- Press and hold down buttons **1** and **2** until LED **3** stops flashing.
 - » LED **3** flashes for about ten seconds.
- Release buttons **1** and **2**.
 - » LED **3** is illuminated.
- Press button **1** or button **2**.
 - » LED **3** goes out.

Replacing battery in the remote-control unit

- with central locking system^{OE}
- with anti-theft alarm system (DWA)^{OE}
- without Keyless Ride^{OE}

If the LED lamp on the remote-control unit fails to light up when a button is pressed, or only lights up briefly:

- Replace the battery in the remote-control unit.

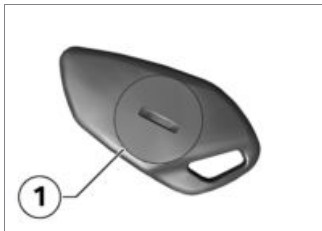

- Open lid of battery compartment **1**.

- Dispose of the old battery in accordance with legal regulations. Do not dispose of the battery in the household waste.



ATTENTION

Unsuitable of improperly inserted batteries.

Component damage

- Use a battery compliant with the manufacturer's specifications.
- When inserting the battery, make sure that the polarity is correct. ◀
- Insert the new battery with the positive side up.



Battery design and nominal battery voltage

for remote control

CR 1632 lithium
3 V

- » The LED on the remote control lights up; the remote control has to be synchronized.

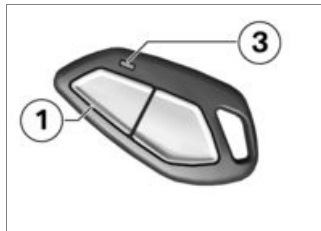

- Press button **1** twice.
- » LED **3** flashes for a few seconds.
- » The remote-control is again ready to be used.

Alarm system(DWA)

- with anti-theft alarm system (DWA)^{OE}

Activate without remote key or radio-operated key

- If applicable, switch on automatic activation of the anti-theft alarm after ignition OFF.
- Customize anti-theft alarm system settings (►► 84).
- Switch off ignition.
 - » Activation takes 30 seconds to complete.
 - » Turn indicators are illuminated twice.
 - » Confirmation tone sounds twice (if programmed).
 - » Alarm system is activated.
- To deactivate the motion sensor (for example if you are about to transport the motorcycle on a train and the swaying movement of the moving train could trip the alarm), call up the **Settings** menu before switching off the ignition.

- Select **Vehicle - Alarm syst. - Sensor**.

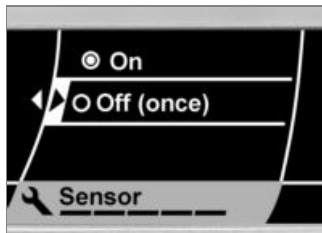

- Select **Off (once)** to switch off the motion sensor this once.
- Switch off ignition.
 - » Activation takes 30 seconds to complete.
 - » Turn indicators are illuminated three times.
 - » Confirmation tone sounds three times (if programmed).
 - » The anti-theft alarm is active, the motion sensor is deactivated.

Activate with remote key or radio-operated key



NOTICE

Only motorcycles without Keyless Ride have a separate remote key for the central locking system and alarm system.◀

- Switch off ignition.

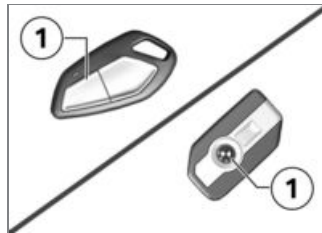

- Press button **1** on the remote key or radio-operated key twice.



NOTICE

See also the other functions of the remote control for the central locking system. ◀

- » Activation takes 30 seconds to complete.
- » Turn indicators are illuminated twice.
- » Confirmation tone sounds twice (if programmed).
- » Alarm system is activated.

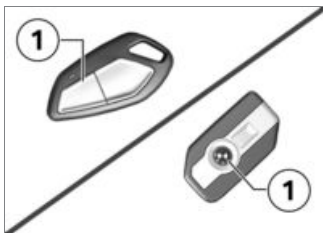

- To deactivate the motion sensor (for example if you are about to transport the motor-

cycle on a train and the swaying movement of the moving train could trip the alarm), press button **1** on the remote key or radio-operated key again during the activation phase.

- » Turn indicators are illuminated three times.
- » Confirmation tone sounds three times (if programmed).
- » Motion sensor is deactivated.

Alarm

The alarm can be triggered by

- the motion sensor
- an attempt to use an unauthorized key to switch on the ignition
- disconnecting the alarm system from the motorcycle battery (alarm system battery takes over the power supply - alarm tone only, no illumination of the turn indicators).

If the battery is discharged all functions remain operational; the only difference is that the alarm cannot be set off if the system is disconnected from the motorcycle battery.

An alarm lasts for approximately 26 seconds. During the alarm, an alarm tone sounds and the turn indicators flash. The type of alarm sound can be programmed in the multifunction display.

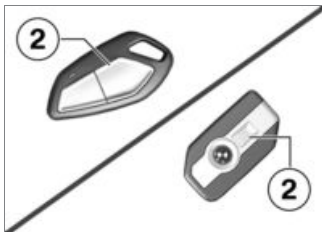

- 1 flash: Motion sensor 1
- 2 flashes: Motion sensor 2
- 3 flashes: ignition switched on with unauthorized key
- 4 flashes: alarm system is disconnected from the motorcycle battery
- 5 flashes: Motion sensor 3

Deactivate without remote key or radio-operated key

- Emergency on/off switch (kill switch) in normal operating position.
- Switch on the ignition.
 - » Turn indicators light up once.
 - » Confirmation tone sounds once (if programmed).
 - » Alarm system is deactivated.

You can cancel an alarm at any time without deactivating the alarm system by pressing button **2** on the remote key or radio-operated key.

If an alarm was triggered while the motorcycle was unattended, the rider is notified accordingly by an alarm tone sounding once when the ignition is switched on. The alarm system indicator lamp then signals the reason for the alarm for one minute. The meanings of the flash codes are as follows:

Deactivate with remote key or radio-operated key

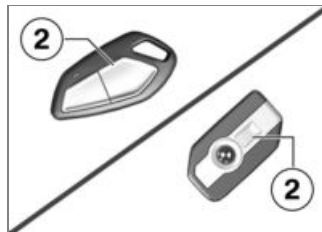

- Press button **2** on the remote key or radio-operated key once.



NOTICE

See also the other functions of the remote control for the central locking system. ◀



NOTICE

If the alarm function is deactivated by means of the remote control and the ignition then not switched on, the

alarm function is automatically reactivated after 30 seconds if "Activation after ignition off" has been programmed.◀

- » Turn indicators light up once.
- » Confirmation tone sounds once (if programmed).
- » Alarm system is deactivated.

Customize anti-theft alarm system settings

- Call up the Settings menu and select **Vehicle - Alarm syst..**

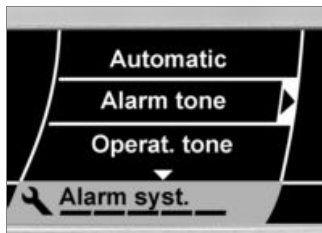

The following settings are available:

- **Automatic - On:** Anti-theft alarm system is activated automatically when the ignition is switched off.
- **Automatic - Off:** Anti-theft alarm system has to be activated with the remote control when the ignition is switched off.
- **Alarm tone:** Type of alarm tone.
- **Operat. tone - On:** Turn indicators flash and one tone sounds as confirmation

when the alarm is switched on or off.

- **Operat. tone - Off:** Turn indicators flash as only confirmation when anti-theft alarm is switched on or off.
- Make the desired adjustment using the Multi-Controller.

Tires

Checking tire pressure



WARNING

Incorrect tire inflation pressure.

Poorer handling characteristic of the motorcycle. Reduced life of tires.

- Ensure proper tire inflation pressure.◀
- Make sure ground is level and firm and park motorcycle.

- Check tire pressures against data below.



Tire pressure, front

42.1 psi (2.9 bar) (With tire cold)



Tire pressure, rear

42.1 psi (2.9 bar) (With tire cold)

If tire pressure is too low:

- Correct tire pressure.

Riding

Safety instructions	88
Starting	90
Breaking in.....	92
Brakes	93
Parking your motorcycle	95
Refueling	96
Securing motorcycle for transport	99

Safety instructions

Rider's Equipment

Do not ride without the correct clothing. Always wear:

- Helmet
- Rider's suit
- Gloves
- Boots

This applies even to short journeys, and to every season of the year. Your authorized BMW Motorrad Dealer will be happy to advise you and has the correct clothing for every purpose.

Correct loading



WARNING

Reduced riding stability caused by overloading and uneven loading.

Accident hazard

- Do not exceed the gross weight limit and observe the loading information.◀
- Adjust spring preload, suspension damping rate settings and tire inflation pressures for the current gross vehicle weight.
- Make sure that weight is uniformly distributed between right and left.
- Pack heavy pieces of luggage and cargo as low and as close to the center of the motorcycle as possible.
- Observe the maximum payload and maximum speed as indicated on the label in the case (see also the chapter "Accessories").
- Observe the maximum payload and maximum speed as indicated on the label in the topcase (see also the chapter "Accessories").

Speed

If you ride at high speed, always bear in mind that various boundary conditions can adversely affect the handling of your motorcycle:

- Settings of spring-strut and shock absorber system
- Imbalanced load
- Loose clothing
- Insufficient tire inflation pressure
- Poor tire tread
- Etc.

Risk of poisoning

Exhaust fumes contain carbon monoxide, which is colorless and odorless but highly toxic.



WARNING

Harmful exhaust gas.

Danger of suffocation

- Do not inhale exhaust fumes.

- Do not run the engine in closed rooms.◀

Burn hazard



CAUTION

Engine and exhaust system become very hot when the motorcycle is in use.

Burn hazard

- After parking the vehicle, make sure that no persons or objects come into contact with the engine and exhaust system.◀

Catalytic converter

If misfiring causes unburned fuel to enter the catalytic converter, there is a danger of overheating and damage.

For this reason, observe the following points:

- Do not run the fuel tank dry.
- Do not run the engine with the spark-plug cap removed.
- Stop the engine immediately if it misfires.
- Use unleaded fuel only.
- Comply with all specified maintenance intervals.



ATTENTION

Unburned fuel in the catalytic converter.

Damage to the catalytic converter.

- Note the points listed for protection of the catalytic converter.◀

Danger of overheating



ATTENTION

Engine idling for a lengthy period while at a standstill.

Overheating caused by insufficient cooling. In extreme cases, the motorcycle could catch fire.

- Do not allow the engine to idle unnecessarily.
- After starting, ride off immediately.◀

Manipulation



ATTENTION

Modifications to the motorcycle (e.g. engine control unit, throttle valves, clutch).

Damage to the affected parts, failure of safety-relevant functions. Damage caused by modifications invalidates the warranty.

- Do not make any modifications.◀

Observe checklist

- Use the following checklist to check your motorcycle at regular intervals.

Before every journey:

- Function of the brake system
- Function of the lighting and signal system
- Check clutch function (▮▮▮ 131).
- Checking tire tread depth (▮▮▮ 132).
- Firm seating of cases and luggage

At every third refuelling stop:

- without Electronic Suspension Adjustment (ESA)^{OE}
- Adjusting spring preload at rear wheel (▮▮▮ 73).◀
- without Electronic Suspension Adjustment (ESA)^{OE}
- Adjust damping on rear wheel (▮▮▮ 74).◀
- with Electronic Suspension Adjustment (ESA)^{OE}
- Adjusting the suspension (▮▮▮ 75).◀

- Check engine oil level (▮▮▮ 124).
- Check front brake pad thickness (▮▮▮ 126).
- Check rear brake pad thickness (▮▮▮ 127).
- Checking front brake fluid level (▮▮▮ 128).
- Checking rear brake fluid level (▮▮▮ 129).
- Check coolant level (▮▮▮ 130).

Starting**Starting the engine**

- Switch on ignition.
- Pre-Ride Check in progress. (▮▮▮ 91)
- ABS self-diagnosis in progress. (▮▮▮ 91)
- DTC self-diagnosis is performed. (▮▮▮ 92)
- Engage neutral, or pull back clutch lever if a gear is engaged.

**NOTICE**

You cannot start the motorcycle with the side stand extended and a gear engaged. The engine will switch itself off if it is started with the transmission in neutral and then a gear is engaged before retracting the side stand.◀

- For cold starts and at low ambient temperatures: pull the lever to disengage the clutch and twist the throttle grip slightly.



- Press starter button **1**.

NOTICE

The starting attempt is automatically interrupted if battery voltage is too low. Recharge the battery before you attempt to start the engine again, or use jumper cables and a donor battery to start. More detailed information can be found in the "Maintenance" chapter under "Jump-starting". ◀

- » Engine starts.
- » Consult the troubleshooting chart if the engine refuses to start. (▶▶▶ 156)

Pre-Ride Check

The instrument cluster runs a test of the indicator lights of the ABS, the ASC, the general warning light and the pointer when the ignition is switched on. During this the logo is shown in the display.

Phase 1



General warning light shows yellow.

Phase 2



General warning light shows red.



The SET light comes on.

If the universal warning light fails to appear in the display:



WARNING

Faulty general warning light.

Lack of display of malfunctions.

- Check that the 'General' warning light comes on, and that it shows red and yellow. ◀
- Have the malfunction corrected as soon as possible at an authorized service facility, preferably an authorized BMW Motorrad retailer.

ABS self-diagnosis

The self-diagnosis routine is determining whether the BMW Motorrad Integral ABS is ready for operation. The self-diagnosis routine launches automatically when you switch on the ignition.

Phase 1

- » Check on system components monitored by diagnostic system while vehicle is parked.



ABS warning light flashes.

Phase 2

- » Checking wheel sensors while starting off. The motorcycle must reach a speed of at least 3.1 mph (5 km/h) before the ABS self-diagnosis routine can be completed.



ABS warning light flashes.

ABS self-diagnosis completed

- » The ABS warning lamp goes out.

If an ABS error is indicated following completion of the ABS self-diagnosis routine:

- It remains possible to continue riding. It should be noted that neither the ABS function nor the integral function is available.
- Have the malfunction corrected as soon as possible at an authorized workshop, preferably an authorized BMW Motorrad retailer.

DTC self-diagnosis

The readiness for operation of the BMW Motorrad DTC is checked by the self-diagnosis. The self-diagnosis routine runs automatically when you switch on the ignition.

Phase 1

- » Check on system components monitored by diagnostic system while motorcycle is parked.



DTC warning light flashes slowly.

Phase 2

- » Checking the diagnosable system components while driving. The engine must be running and the motorcycle must reach a speed of at least 3 mph (5 km/h) in order for DTC self-diagnosis to complete.



DTC warning light flashes slowly.

DTC self-diagnosis completed

- » The DTC symbol is no longer displayed.

If a DTC error is indicated after the DTC self-diagnosis is completed:

- It remains possible to continue riding. It must be noted that the DTC function is not available.
- Have the malfunction corrected as soon as possible at an authorized service facility, preferably an authorized BMW Motorrad retailer.

Breaking in Engine

- While running in the motorcycle, vary the throttle opening and engine-speed range frequently; avoid driving for long periods at a constant speed.
- Try to do most of your riding during this initial period on twisting, fairly hilly roads, avoiding highways if possible.

- Observe the engine run-in speeds.

 Engine run-in speed
<5000 min ⁻¹ (Odometer reading 0...186 miles (0...300 km))
<6000 min ⁻¹ (Odometer reading 186...621 miles (300...1000 km))
no full throttle (Odometer reading 0...621 miles (0...1000 km))

- Have first run-in check conducted after 300 - 750 mls (500 - 1,200 km).

Brake pads

New brake pads must be run in before they achieve their optimum friction force. This initial reduction in braking efficiency can be compensated for by exerting greater pressure on the brake levers.

WARNING

New brake pads.

Extension of the braking distance. Accident hazard.

- Brake early.◀

Tires

New tires have a smooth surface. This must be roughened by riding in a restrained manner at various heel angles until the tires are run in. This running in procedure is essential if the tires are to achieve maximum grip.

WARNING

Loss of adhesion of new tires on wet roads and at extreme angles.

Accident hazard

- Always think well ahead and avoid extreme angles.◀

Brakes

How do you achieve the shortest stopping distances?

The dynamic load distribution between the front and rear wheel changes during braking. The heavier you brake, the greater the weight transfer to the front wheel. Increases in the load at an individual wheel are accompanied by a rise in the effective braking force that the wheel can provide.

To achieve the shortest possible braking distance, the front brake must be applied quickly and with increasing force. This procedure provides ideal exploitation of the extra weight transfer to the front wheel. The clutch should also be disengaged at the same time. With the "forced braking" often practiced in which the brake pressure is generated as quickly

as possible and with great force, the dynamic load distribution cannot follow the increased deceleration and the braking force cannot be completely transferred to the road surface.

BMW Motorrad Integral ABS prevents the front wheel from locking.

Descending mountain passes

WARNING

Braking only with the rear-wheel brake when descending mountain passes.

Loss of braking action. Destruction of the brakes caused by overheating.

- Apply the front wheel brake and use the engine brake.◀

Wet, soiled brakes

Moisture and dirt on the brake disks and the brake pads result in a decrease in the braking action. Delayed or poorer braking action must be expected in the following situations:

- When driving in the rain and through puddles.
- After washing the motorcycle.
- When driving on roads spread with salt.
- After working on the brakes due to oil or grease residues.
- When driving on soiled roads or offroad.

WARNING

Moisture and dirt.

Poorer braking action.

- Brake until brakes are dry or clean; clean if necessary.
- Brake early until the full braking action is available again.◀

ABS Pro

Physical riding limits

WARNING

Braking in curves.

Danger of falling despite ABS Pro

- The rider is always responsible for adapting his/her driving style.
- Do not reduce the system's extra safety margin with careless riding or unnecessary risks.◀

ABS Pro is available in all riding modes.

Falling cannot be excluded

Although ABS Pro represents valuable support and an enormous safety advantage for the rider when braking in the inclined position, it by no means redefines the physical riding limits. It is still possible to exceed those limits through misjudgments or

riding errors. In extreme cases this may result in a fall.

Use on public roads

ABS Pro helps make riding your motorcycle on public roads even safer. When braking due to unexpected hazards in curves, locking-up and slipping of the wheels is prevented within the scope of the physical riding limits.

NOTICE

ABS Pro was not developed to increase the individual braking performance in the inclined position in the limit range.◀

Parking your motorcycle

Side stand

- Switch off engine.

ATTENTION

Poor ground conditions in area of stand.

Component damage caused by tipping over.

- Always check that the ground under the stand is level and firm.◀
- Fold out side stand and park motorcycle.

ATTENTION

Loading of the side stand with additional weight.

Component damage caused by tipping over.

- Do not sit on the motorcycle when it is parked on the side stands.◀
- If the slope of the road permits, turn the handlebars to the left.

- On a grade, the motorcycle should always face uphill; select 1st gear.

Center stand

- Switch off engine.

ATTENTION

Poor ground conditions in area of stand.

Component damage caused by tipping over.

- Always check that the ground under the stand is level and firm.◀

ATTENTION

Folding in of the main stand during strong movements.

Component damage caused by tipping over.

- Do not sit on the motorcycle while it is resting on the center stand.◀

- Fold out center stand and jack up motorcycle.

Refueling

Fuel specifications

For optimal fuel economy, the gasoline should be sulfur-free or very low in sulfur content.



ATTENTION

Leaded fuel.

Damage to the catalytic converter.

- Do not refuel with leaded gasoline or gasoline with metallic additives, e.g. manganese or iron. ◀



ATTENTION

Use of Ethanol E85 as fuel.

Damage to the engine and fuel supply.

- Do not refuel with E85, i.e. fuel with an ethanol content of 85 %, or with Flex Fuel. ◀
- Fuels with a maximum ethanol content of 10 %, i.e. E10, may be used for refueling.



Recommended fuel quality

Super unleaded (max. 10 % ethanol, E10)
89 AKI (95 ROZ/RON)
89 AKI

Refueling procedure



WARNING

Fuel is highly flammable.

Fire and explosion hazard.

- Do not smoke. Never bring a naked flame near the fuel tank. ◀



ATTENTION

Fuel attacks plastic surfaces.

Surfaces become unattractive or cloudy.

- Immediately clean plastic parts after contact with fuel. ◀
- Make sure ground is level and firm and park motorcycle.
- Open protective cap.

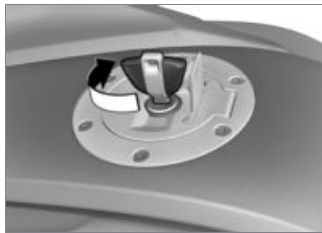

- Unlock cap of fuel tank with ignition key and fold up.



WARNING

Escaping of fuel due to expansion under exposure to heat with overfilled fuel tank.

Accident hazard

- Do not overfill the fuel tank.◀
- Refuel with a fuel meeting the specifications below, continuing until fuel is no higher than lower edge of filler neck.

NOTICE

When refueling after running on fuel reserve, the resulting total fuel quantity must be greater

than the fuel reserve, so that the new filling level is detected and the fuel warning light is switched off.◀

 Usable fuel quantity

Approx. 7 gal (Approx. 26.5 l)

 Reserve fuel quantity

Approx. 1.1 gal (Approx. 4 l)

- Press fuel tank cap down firmly to close.
- Remove vehicle key and close protective cap.

Refueling procedure

– with Keyless Ride^{OE}

Steering lock is unlocked.

WARNING

Fuel is highly flammable.

Fire and explosion hazard.

- Do not smoke. Never bring a naked flame near the fuel tank.◀

WARNING

Escaping of fuel due to expansion under exposure to heat with overfilled fuel tank.

Accident hazard

- Do not overfill the fuel tank.◀

ATTENTION

Fuel attacks plastic surfaces.

Surfaces become unattractive or cloudy.

- Immediately clean plastic parts after contact with fuel.◀
- Make sure ground is level and firm and place motorcycle on side stand.

NOTICE

The available fuel tank volume can only be optimally used with

the vehicle standing on the side stand.◀

- with Keyless Ride^{OE}
- Switch off ignition (▶▶ 48).

NOTICE

After the ignition is switched off, the fuel filler cap can be opened within the specified run-on time even without the radio-operated key being within the reception area.◀



After-running period for opening the fuel filler cap

2 min

- » There are **2 ways** to open the fuel filler cap:
 - Within the run-on time
 - After run-on time expires

Version 1

- with Keyless Ride^{OE}

Within the run-on time

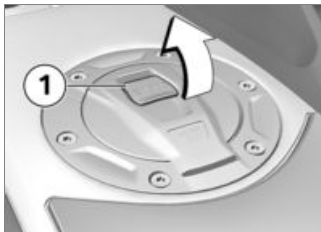

- Slowly pull lug **1** of fuel filler cap upward.
- » Fuel filler cap unlocked.
- Open fuel filler cap completely.

Version 2

- with Keyless Ride^{OE}

After run-on time expires

- Bring radio-operated key into reception range.
- Slowly pull up lug **1**.

- » The indicator light for the radio-operated key flashes as long as the radio-operated key is being searched for.
- Slowly pull lug **1** of fuel filler cap upward again.
- » Fuel filler cap unlocked.
- Open fuel filler cap completely.



- Refuel with a fuel meeting the specifications above, continuing until fuel is no higher than lower edge of filler neck.

NOTICE

When refueling after running on fuel reserve, the resulting total

fuel quantity must be greater than the fuel reserve, so that the new filling level is detected and the fuel warning light is switched off. ◀

NOTICE

The "usable fuel quantity" specified in the technical data is the fuel quantity, which can be refueled if the fuel tank was completely emptied, i.e., if the engine dies off due to lack of fuel. ◀



Usable fuel quantity

Approx. 7 gal (Approx. 26.5 l)



Reserve fuel quantity

Approx. 1.1 gal (Approx. 4 l)

- Press fuel filler cap of fuel tank down firmly.
- » Fuel filler cap audibly engages.

- » Fuel filler cap automatically locks after run-on time expires.
- » The engaged fuel filler cap locks immediately when the steering lock is locked or during starting.

Securing motorcycle for transport

- Protect all components along which straps are routed against scratching. For example, use adhesive tape or soft cloths.



ATTENTION

Motorcycle tips to the side when raising.

Component damage cause by tipping over.

- Secure the motorcycle against tipping to the side, preferably with the assistance of a second person. ◀
- Push motorcycle onto transport surface, and do not place on side stand or center stand.

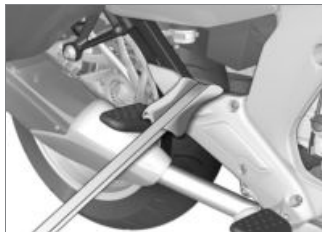
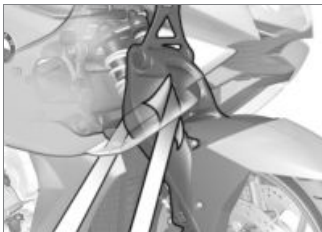
**ATTENTION****Incorrect routing of tensioning straps.**

Damage to brake lines, cables, storage and fairing.

- Route tensioning straps carefully.
- Protect painted components from scratching with a cloth.◀
- Pass the straps on left and right through the suspension and strap the motorcycle down.

- Fasten straps at rear on both sides on rear frame and tension.
- Do not pull the straps over the footpegs.
- Uniformly tighten all the straps.

Technology in detail

Riding mode	102
Hill Start Control	103
Brake system with BMW Motorrad Integral ABS	103
Engine management with BMW Motorrad DTC	107
Tire Pressure Control TPC/ RDC	108
ESA II Electronic Suspension Ad- justment	109

Riding mode

Selection

Three riding modes allow the motorcycle's characteristics to adapt to the prevailing weather conditions, the road and traffic, and the rider's style of riding:

- RAIN
- ROAD
- DYNAMIC

Each riding mode affects the behavior of the motorcycle in a different way. DTC can be switched off in each mode; the explanations below invariably refer to conditions with the system switched ON. The last selected riding mode is reactivated automatically after the ignition is switched off and on again.

The following always applies: The sportier the selected mode, the more directly the engine output can be utilized. At the same time, the level of rider assistance

that the DTC system offers decreases accordingly.

Therefore, consider the following when selecting the riding mode: The sportier the setting, the more demanding the requirements for the driving skill of the rider are!

RAIN

The engine output is only partially available. Power increase when you open the throttle is reserved, engine response is correspondingly soft.

The DTC system intervenes early enough to prevent the rear wheel from spinning. On road surfaces with high to medium grip (dry and wet asphalt to dry cobblestones) the motorcycle remains very stable; movements of the tail are clearly perceptible only on slippery road surfaces (wet bitumen or wet cobblestones).

ROAD

In this mode the full engine output is available. Power increase when you open the throttle is more direct than in RAIN mode, the engine responds more rapidly.

DTC system intervention is later than in RAIN mode. The vehicle remains stable on road surfaces with high to moderate coefficients of friction (traction) (dry and wet asphalt as well as dry cobblestones). Slight rear-wheel drift is perceptible. Movements of the tail are clearly perceptible on slippery road surfaces (wet bitumen or wet cobblestones).

DYNAMIC

The DYNAMIC mode is the sportiest mode. Power increase and engine response are the same as in ROAD mode. However, the driver's

request is implemented much more directly.

DTC system intervention is even later, which means that even on dry asphalt drifting is possible under sharp acceleration when cornering.

Switchover

A mode change involving functions in the engine management system and the DTC system is possible only when drive torque is not applied to the rear wheel.

To obtain this state,

- the motorcycle must be stopped with the ignition switched on,

or

- the throttle must be turned back,
- the clutch must be actuated.

First the desired driving mode is preselected. The switchover does not take place until the affected systems are in the required state.

The selection menu does not disappear in the display until the driving mode has been switched over.

Hill Start Control

Hill Start Control

– with Hill Start Control^{OE}

Hill Start Control relies on partial integration of the ABS system to prevent the motorcycle from rolling back on hills, making it unnecessary for the rider to maintain constant pressure on the brake lever when starting on a slope. When Hill Start Control is activated, pressure is generated in the rear brake circuit to ensure that the motorcycle remains stationary on a sloping surface. The

brake system's actual holding pressure varies according to the inclination angle of the slope.

Brake system with BMW Motorrad Integral ABS

Partially integral brake

Your motorcycle is equipped with a partially integral brake configuration. Both front and rear brakes are applied simultaneously when you pull the handbrake lever.

The footbrake lever acts only on the rear brake.

The BMW Motorrad Integral ABS adapts the braking force distribution between the front and rear wheel brake to the loading of the motorcycle during braking.



ATTENTION

Spinning of the rear wheel with the front brake applied

(Burn Out) is prevented by the integral function.

Damage to rear-wheel brake and clutch.

- Do not attempt Burn Outs.◀

How does ABS work?

The maximum braking force that can be transferred to the road surface is partially dependent on the friction coefficient of the road surface. Gravel, ice, snow and wet roads offer a considerably poorer friction coefficient than a dry, clean asphalt surface. The poorer the friction coefficient of the road surface is, the longer the braking distance will be.

If the maximum transferrable braking force is exceeded when the driver increases the brake pressure, the wheels begin to lock and driving stability is lost, and a fall can result. Before this situation occurs, ABS intervenes and adjusts the brake pressure

to the maximum transferrable braking force. This enables the wheels to continue to turn and maintains driving stability regardless of the road surface condition.

What happens when rough roads are encountered?

Bumpy or rough roads can briefly lead to a loss of contact between the tires and the road surface, until the transferrable braking force is reduced to zero. If braking is carried out in this situation, ABS must reduce the brake pressure to ensure driving stability when restoring contact to the road. At this point in time, the BMW Motorrad Integral ABS must assume extremely low friction coefficients (gravel, ice, snow) so that the running wheels turn in every imaginable case and the driving stability is ensured.

After detecting the actual conditions, the system adjusts the optimum brake pressure.

How is the BMW Motorrad Integral ABS noticeable to the rider?

If the ABS system must reduce the braking forces due to the conditions described above, then vibrations can be felt at the handbrake lever.

If the handbrake lever is pulled, then braking pressure is built up at the rear wheel with the integral function. If the footbrake lever is first actuated after this, the brake pressure already built up can be felt earlier than the counter-pressure, than when the footbrake lever is actuated before or together with the handbrake lever.

Lifting off rear wheel

Even during severe braking, a high level of tire grip can mean that the front wheel does not lock up until very late, if at all. Consequently, ABS does not intervene until very late, if at all. Under these circumstances the rear wheel can lift off the ground, and the outcome can be a high-siding situation in which the motorcycle can flip over.

WARNING

Lifting off of the rear wheel due to heavy braking.

Accident hazard

- When braking heavily, bear in mind that the ABS control cannot always be relied on to prevent the rear wheel from lifting off the ground. ◀

What are the design characteristics of the BMW Motorrad Integral ABS?

The BMW Motorrad Integral ABS ensures driving stability on any surface within the limits of driving physics. The system is not optimized for special requirements resulting under extreme weather conditions offroad or on the race-track.

Special situations

To detect the tendency of the wheels to lock up, the speeds of the front and rear wheel are compared. If implausible values are detected over a longer period of time, the ABS function is deactivated for safety reasons and an ABS fault is indicated. The condition for a fault code is the completed self-diagnosis. In addition to problems on the BMW Motorrad Integral ABS,

unusual driving conditions can also lead to a fault code.

Unusual driving conditions:

- Heating up on the main or auxiliary stand at idle or with gear engaged.
- Rear wheel locked by the engine brake for a lengthy period, for example while descending on a loose surface.

Should a fault code result due to one of the driving conditions described above, the ABS function can be reactivated by switching the ignition off and then on again.

How important is regular maintenance?

WARNING

Failure to have maintenance performed on the brake system regularly.

Accident hazard

- To ensure that the ABS is in a properly maintained condition, it is vital that the specified service intervals be observed. ◀

Reserves for safety

But remember: the potentially shorter braking distances which BMW Motorrad Integral ABS permits must not be used as an excuse for careless riding. ABS is primarily a means of ensuring a safety margin in genuine emergencies.

Be careful in curves! When you apply the brakes on a corner, the motorcycle's weight and momentum take over and even BMW Motorrad Integral ABS is unable to counteract their effects.

Further development of ABS to ABS Pro

In the past, the BMW Motorrad ABS system provided for a very high level of safety while braking during straight-ahead riding. Now ABS Pro also offers increased safety even when braking in curves. ABS Pro prevents locking-up of the wheels even in case of rapid brake actuation. ABS Pro reduces abrupt changes in steering forces, especially during panic braking, and therefore decreases the risk of unwanted wheelies occurring.

ABS control

From a technical standpoint, ABS Pro adjusts the ABS control to the angle of inclination of the motorcycle in dependence on the respective riding situation. Signals for the roll and yaw rate and the lateral acceleration are used to determine the incli-

nation of the motorcycle. The signals come from the yaw rate sensor, which is already used for Dynamic Traction Control DTC and for Dynamic ESA.

With an increasing inclination, the braking pressure gradient is increasingly limited at the start of braking. This results in a slower pressure buildup. In addition, the pressure modulation in the range of the ABS control is more uniform.

Advantages for the driver

The advantages of ABS Pro for the rider are sensitive response and high braking and riding stability with the best possible deceleration, even in curves.

Engine management with BMW Motorrad DTC

How does DTC work?

The BMW Motorrad DTC compares the wheel speeds of the front and rear wheel. Differences in the relative rotation speeds allow the system to determine the slip rate, and thus the stability reserves at the rear wheel. The engine-management system adapts the engine torque when the slip limit is exceeded.

WARNING

Risky riding style.

Accident hazard despite DTC.

- The rider is always responsible for adapting his/her driving style.
- Do not reduce the system's extra safety margin with careless riding or unnecessary risks. ◀

What is the design baseline for BMW Motorrad DTC?

BMW Motorrad DTC is designed as an assistant system for the rider and for use on public roads. The extent to which the rider affects DTC control can be considerable (weight shifts when cornering, items of luggage loose on the motorcycle), especially when style of riding takes rider and machine close to the limits imposed by physics.

The system is not optimized for the special conditions encountered under extreme weather during off-road and race-track use. You have the option of deactivating the BMW Motorrad DTC system for these circumstances.

WARNING

Risky riding style.

Accident hazard despite DTC.

- The rider is always responsible for adapting his/her driving style.
- Do not reduce the system's extra safety margin with careless riding or unnecessary risks. ◀

Special situations

As lean angles increase, acceleration potential is also progressively restricted by the laws of physics. This can result in reduced acceleration when coming out of very tight curves.

To detect spinning or slipping away of the rear wheel, the speeds of the front and rear wheel are compared and the angle is considered, for example. If these values are detected to be implausible for a long period, a replacement value is used for the angle and the DTC function is deactivated. In these cases,

a DTC error is displayed. A self-diagnosis routine must be completed before the error will be displayed.

The BMW Motorrad DTC can issue an error message under the exceptional riding conditions outlined below.

Unusual riding conditions:

- Driving on the rear wheel (wheelie) for a longer period with DTC deactivated.
- Rear wheel spinning in place with front brake engaged (burn out).
- Heating up on an auxiliary stand at idle speed or with gear engaged.

If the front wheel loses contact to the ground during extreme acceleration, the DTC reduces the engine torque until the front wheel touches the ground again. BMW Motorrad recommends that you respond to this condi-

tion by twisting back the throttle grip somewhat to return to stable dynamic operating conditions as quickly as possible.

On a slippery surface, the throttle grip should never be suddenly twisted back completely unless the clutch is disengaged at the same time. The engine braking torque can cause the rear wheel to slip, resulting in an unstable driving state. This case cannot be controlled by the BMW Motorrad DTC.

Tire Pressure Control TPC/RDC

- with Tire Pressure Control (TPC/RDC)^{OE}

Function

A sensor is located in each tire, which measures the air temperature and the inflation pressure

inside the tire and sends these values to the control unit.

The sensors are equipped with a switch, which does not enable the transmission of the measured values until a speed of approx. 19 mph (30 km/h) is reached. The display shows "--" for each tire until the tire-pressure signal is received for the first time. The sensors continue to transmit the measured values for approx. 15 minutes after the motorcycle comes to a stop.

If a TPC/RDC control unit is installed, however the wheels have no sensors, then an error message is output.

Temperature compensation

The tire inflation pressure is temperature dependent, i.e., it increases or decreases together with the tire temperature. The tire temperature is dependent on

the ambient temperature and on the driving style and duration. The tire inflation pressures are shown temperature-compensated in the multifunction display; they refer to a tire temperature of 20 °C. No temperature compensation takes place in the inflation pressure testers at filling stations, meaning that the measured tire inflation pressure varies according to tire temperature. As a result, the pressure figures indicated by the gauges at filling stations will usually vary from those appearing in the multifunction display. The warmer the tire, the higher the gauge reading by comparison with the reading shown on the display.

Adjusting inflation pressure

Compare the TPC/RDC value in the multifunction display with the value on the back cover of the Rider's Manual. The difference between the two values must be compensated with the air pressure tester at the filling station.

Example: According to the Rider's Manual, the tire inflation pressure is to be 42 psi (2.9 bar), however 39 psi (2.7 bar) is shown in the multifunction display. The tester at the filling station indicates 36 psi (2.5 bar). This value must be increased by 3 psi (0.2 bar) to 39 psi (2.7 bar) in order to produce the correct tire inflation pressure.

ESA II Electronic Suspension Adjustment

– with Electronic Suspension Adjustment (ESA)^{OE}

Chassis adjustments

The proper loading state must first be selected when the motorcycle is stationary according to the motorcycle's load. Depending on the riding mode selected, the damping levels are set on both spring struts and the spring base and spring rate are set on the rear spring strut. If the selected riding mode is changed, the spring rate on the rear spring strut is also adjusted in addition to the damping of both spring struts. This enables very precise adjustment of the chassis to all riding conditions, including while riding.

- The combination of spring base, damping and spring rate ensures the chassis geometry is always appropriate.
- The static normal position is virtually maintained while riding.
- The different driving and loading statuses are offset so that the drivability of the motorcycle remains constant.

It is possible to electrically change the spring rate through the combination of a conventional coil spring with a plastic element (Elastogran), the lateral expansion of which can be electrohydraulically limited using a displaceable sleeve. The more the sleeve surrounds the plastic element, the more its expansion is limited and the spring rate increases. The highest spring rate is achieved when the sleeve completely encloses the plastic element and sits on the steel

spring. Accordingly, the spring rate is lower, the less the sleeve limits the expansion of the plastic element.

Accessories

General instructions.....	112
Onboard power sockets	112
Navigation device	113
Case	116
Topcase	119

General instructions

CAUTION

Use of products from other manufacturers.

Safety risk

- BMW Motorrad cannot examine or test each product of outside origin to ensure that it can be used on or in connection with BMW motorcycles without constituting a safety hazard. Nor is this guarantee provided when the official approval of a specific country has been granted. Tests conducted by these instances cannot make provision for all operating conditions experienced by BMW motorcycles and, consequently, they are not sufficient in some circumstances.
- Use only parts and accessories approved by BMW for your motorcycle. ◀

The safety, operation and suitability of the parts and accessory products have been checked extensively by BMW. Therefore, BMW assumes responsibility for these products. BMW shall not be liable for unapproved parts and accessory products of any kind.

Whenever you are planning modifications, comply with all the legal requirements. The vehicle must not violate the regulations governing vehicle approval for highway use applicable in your own country.

Observe the information on the importance of tire sizes for chassis control systems (► 133). Your authorized BMW Motorrad retailer offers you qualified advice in choosing genuine BMW parts, accessories and other products. You will find all BMW Motorrad optional accessories on

our website: "www.bmw-motorrad.com".

Onboard power sockets

Information on using onboard power sockets:

Automatic deactivation



If this warning symbol appears it tells you that the onboard system voltage is low. The onboard sockets might be temporarily switched off.

The onboard sockets are also switched off when the engine is being cranked by the starter and if maximum load capability as stated in the technical data is exceeded.

If several onboard sockets are being operated, the total current may not exceed the maximum loadability.

Operating electrical accessories

You can start using electrical accessories connected to an on-board socket only when the ignition is switched on. If you subsequently switch off the ignition the sockets are also switched off if the power drain caused by their electrical consumers is high. If the power drain is low the sockets remain operational for a certain period of time before being switched off.

Cable routing

The cords from the power sockets to the devices must be routed in such a way that they:

- do not interfere with the rider's freedom of movement
- do not limit steering angles and handling characteristics
- cannot be caught or trapped.

Navigation device

– with navigation system^{OA}

Installing navigation device

- Switch on ignition.



- Press button **1** to open the slot for the navigation device.
 - » Slot cover pops open, wind-screen moves to top limit position.
- Pull slot cover up as far as it will go.
- From behind, push out cap **2**.



- Operate latch **3** and remove cover **4**.

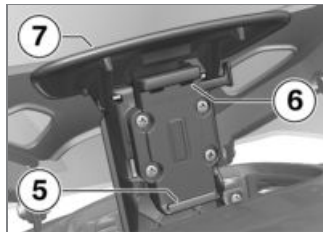

- Initially insert the navigation device into mount **5**, then press it into latching mechanism **6**.

- Check that the navigation device is secure in the cradle.
- Press cover **7** to push cradle with navigation device into the slot until it snaps into position.

Removing navigation device

- Switch on ignition.



- Press button **1** to open the slot for the navigation device.
- » Slot cover pops open, windshield moves to top limit position.

- Pull slot cover up as far as it will go.



- Operate latch **3**, pull the navigation device forward out of holder **6** and lift it up and out.



- Install cover **4**.
- Press cover **7** to push the cradle into the slot until it snaps into position.



- Insert cap **2**.

Operating navigation device

- If applicable, switch on the navigation device.
- Call up the **Navigation** menu.

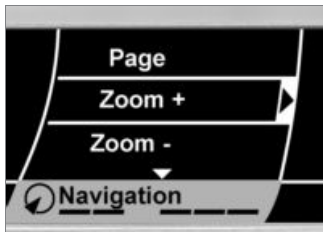

The options for using the navigation device appear on the display.

- **Page**: You can page from view to view; the choices are main menu, map and onboard computer.
- **Zoom +**: Performs functions marked with a plus sign + in the navigation system. In the map view, for instance, the

view zooms in on the map detail.

- **Zoom -**: Performs functions marked with a minus sign - in the navigation system. In the map view, for instance, the view zooms out from the map detail.
- **Speak**: The last navigation announcement is spoken again. The announcement is spoken again even if automatic spoken announcements have been switched off in the settings of the navigation system.
- **Mute**: Automatic spoken announcements are toggled off and on.
- **Display Off**: The display of the navigation device is toggled off and on.
- Select the function you want and implement the function by pushing the Multi-Controller to the right.

Special functions

Integration of the BMW Motorrad Navigator IV into the K 1600 GTL series has produced a number of deviations from the descriptions in the operating instructions for the Navigator.

Traffic channel (TMC)

If the motorcycle is fitted with an audio system, the audio system sends the traffic announcements to the Navigator. The symbol described in the operating instructions for the Navigator appears on the display.

It is not possible to receive traffic announcements from subscription services via the BMW Motorrad audio system.

Reserve fuel level warning

The settings for the fuel gauge allow you to define a distance that is covered per tankful of fuel. The motorcycle transmits the

figure for residual travel range on the fuel remaining in the tank to the Navigator GPS receiver, rendering manual entry of this information redundant.

Time and date

The Navigator GPS receiver transmits the time and date to the motorcycle. Acceptance of these data for the readings on the instrument panel has to be activated in the user settings for the motorcycle.

Security settings

The BMW Motorrad Navigator IV can be secured against unauthorized use with a four-digit PIN (Garmin Lock). When this function is activated, once the Navigator GPS receiver is cradled on the motorcycle and the ignition is switched on you will receive a prompt asking whether the motorcycle should be added to the list of secure vehicles. If you an-

swer "Yes" at this prompt the Navigator saves the VIN of this vehicle in its internal memory. A maximum of five VINs can be saved in this way.

Subsequently, the PIN does not have to be entered when the Navigator is switched on by ignition ON while cradled in any of these vehicles.

If the Navigator is removed from the vehicle while switched on, a security prompt asking for the PIN to be entered is issued.

Screen brightness

Screen brightness is adjusted by the motorcycle while the unit is cradled. There is no provision for manual input.

Case

Opening case

- with central locking system^{OE}
- If applicable, open the central locking. ◀



- Turn the key to the in the case lock to the position indicated by the dot.

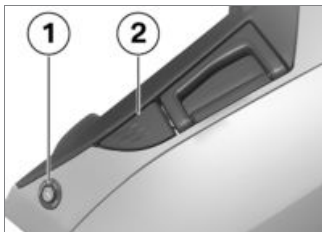

- Press lock barrel **1** downward.
» Release lever **2** pops up.
- Pull the release lever all the way up and open the lid of the case.

Closing case



- Pull release lever **2** all the way up.
- Close case lid and press down. Ensure that no luggage is trapped between lid and case.

NOTICE

The case can also be locked if the lock is in the LOCK position. Under such circumstances, ensure that the ignition key is not in the case.◀

- Push release lever **2** down, continuing until it engages.

- Turn key in case lock into LOCK position and remove.

Removing case



- Turn key in case lock to RE-LEASE position.
» Handle pops out.



- Pull carry handle **3** up as far as it will go.
» Case is released and can be removed.

Mounting case

- Fold up handle as far as possible.



- Insert case in brackets **4**.



- Press handle **3** down until it engages.
- Turn key in case lock into LOCK position and remove.

Maximum payload and maximum speed

Observe maximum payload and maximum speed as indicated on label in case.

If you cannot find your combination of vehicle and case on the label, contact your BMW Motorrad Retailer.

The following values apply to the combination described here:



Maximum speed for riding with case

max 112 mph (max 180 km/h)



Payload per case

max 22 lbs (max 10 kg)

Topcase

Open Topcase

- with central locking system^{OE}
- If applicable, open the central locking.◁



- Turn the key in the topcase lock to the position indicated by the dot.

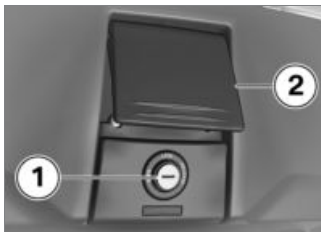

- Press lock barrel **1** forward.
 - » Release lever **2** pops up.
- Pull the release lever all the way up and open the lid of the topcase.

Closing the Topcase



- Pull release lever **2** all the way up.
- Close Topcase lid and hold it down. Ensure that no luggage is trapped between lid and case.
- Push release lever **2** down, continuing until it engages.
- Turn key in Topcase lock into LOCK position then extract it.

Removing Topcase



- Use the ignition key to unlock seat lock **1** and lift the rear of the seat.

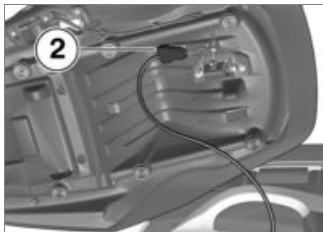

- Disconnect plug **2** of the seat heating and remove the seat.

- Place the seat, upholstered side down, on a clean surface.
- Switch off ignition.



- Disconnect plug connection **1**.
- Work the topcase end-plug through to the rear.
- Open Topcase (▣▣▣▣ 119).
- If applicable, empty the topcase and lift out the bottom mat.



- Push slide latch **2** toward the outside and hold it in this position.
- Turn rotary latch **3** clockwise as far as it will go.
» Release warning **4** is visible.
- Closing the Topcase (▣▣▣▣ 119).



- Raise the rear of the topcase and pull it off luggage rack.

Mounting Topcase

- If applicable, empty the topcase and lift out the bottom mat.



- Set the topcase on the luggage carrier.
- Open Topcase (▶▶▶ 119).



- Turn rotary latch **3** counter-clockwise as far as it will go,

while pressing down on the back edge of the topcase.
» Release warning **4** is no longer visible.

If the release warning is still visible the topcase is not correctly secured.

- Do not attempt to set the motorcycle in motion. Make sure that the topcase is correctly seated on the luggage carrier.

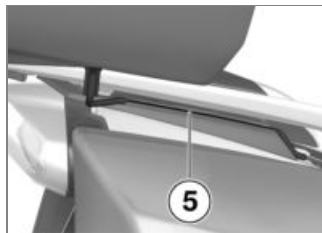

- Route the connecting cable forward in cable guide **5**.

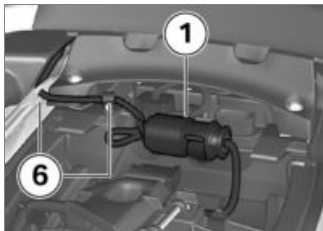

- Work the cable into position at positions **6**.
- Close plug connection **1**.

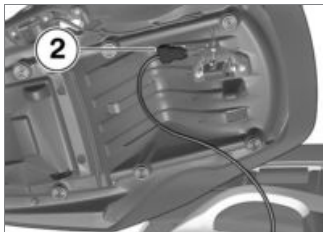

- Connect plug **2** of the seat heating.

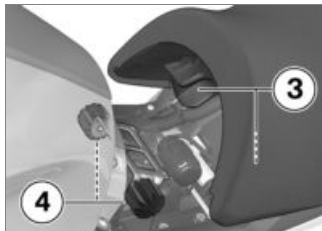



- Position the seat with mounts **3** in rubber buffers **4** on left and right.
- Lower the rear of the seat and engage the seat in the latching mechanism.

Maximum payload and maximum speed

Observe maximum payload and maximum speed as indicated on label in the topcase.

If you cannot find your combination of vehicle and topcase on the label, contact your BMW Motorrad Retailer.

The following values apply to the combination described here:

	Maximum speed limit for driving with a Topcase
	max 112 mph (max 180 km/h)
	Payload of Topcase
	max 22 lbs (max 10 kg)

Maintenance

General instructions.....	124
Onboard tool kit	124
Engine oil	124
Brake system	126
Coolant	130
Clutch	131
Wheel rims and tires	132
Wheels	132
Front wheel stand	139
Jump-starting.....	140
Light sources	141
Battery.....	145
Fuses	148

General instructions

The 'Maintenance' chapter describes work involving the checking and replacement of wear parts that can be performed with a minimum of effort.

If special tightening torques are to be taken into account for assembly, these are listed. An overview of all required tightening torques is contained in the chapter "Technical Data".

Information on additional maintenance and repair work is provided in the Repair Manual for your vehicle on DVD, which you can obtain from your authorized BMW Motorrad retailer.

Special tools and thorough specialized knowledge are required to carry out some of the work described here. If you are in doubt, consult an authorized workshop, preferably your authorized BMW Motorrad retailer.

Onboard tool kit Standard tool kit

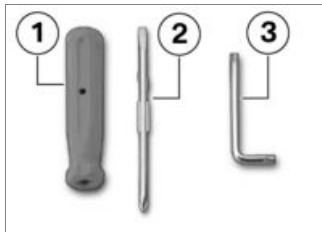

- 1 Screwdriver handle
- 2 Reversible screwdriver insert
Phillips PH1 and Torx T25
– Adjust damping on rear wheel (▶▶▶ 74).
- 3 Torx wrench, T25/T30
T25 on short end, T30 on long end
– Replace bulb for high-beam headlight (▶▶▶ 141).

- 3 – Adjusting shift lever (▶▶▶ 72).
– Remove license-plate carrier.

Engine oil

Check engine oil level



WARNING

Engine oil level too low.

Risk of an accident caused by the engine blocking.

- Always make sure that the oil level is correct. ◀



ATTENTION

The oil level varies with the temperature of the oil. The higher the temperature, the higher the level of oil in the sump.

Misinterpretation of the oil capacity

- Only check the oil level after a longer journey or when the engine is warm. ◀
- Make sure the surface is level and firm and place the motorcycle on its main stand at operating temperature.
- Allow engine to idle until fan starts, then let it continue running for an additional minute.
- Switch off the engine and wait for about one minute to allow the oil to drain into the sump.
- Wipe area around oil fill location to clean it.

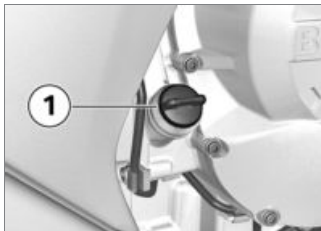

- Remove oil dipstick **1** and wipe it with a clean, dry cloth.
- Position oil dipstick on oil filler opening, but do not screw in.
- Remove oil dipstick and read fluid level.

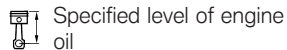
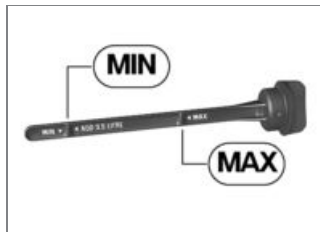

Specified level of engine oil
between MIN and MAX marking (Engine at operating temperature)

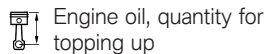

Engine oil, quantity for topping up
max 0.5 quarts (max 0.5 l) (Difference between MIN and MAX)

If oil level is below MIN mark:

- Topping up engine oil (➡ 126).

If oil level is above MAX mark:

- Have oil level corrected at an authorized service facility, preferably an authorized BMW Motorrad retailer.
- Install oil dipstick.

Topping up engine oil

- Make sure ground is level and firm and park motorcycle.
- Wipe area around fill location clean.



- Remove oil dipstick **1**.



ATTENTION

Too little or too much engine oil.

Engine damage

- Always make sure that the oil level is correct.◀
- Add engine oil up to specified level.
- Check engine oil level (➡ 124).
- Install oil dipstick.

Brake system

Checking brake operation

- Make sure ground is level and firm and park motorcycle.
- Actuate the handbrake lever.
 - » Pressure point must be clearly perceptible.
- Actuate the footbrake lever.
 - » Pressure point must be clearly perceptible.

If no clear pressure points are perceptible:



ATTENTION

Improper working on the brake system.

Endangering of the operating safety of the brake system.

- Have all work on the brake system carried out by experts.◀
- Have the brakes checked at an authorized workshop, preferably an authorized BMW Motorrad retailer.

Check front brake pad thickness

- Make sure ground is level and firm and park motorcycle.



- Visually inspect left and right brake pads to determine their thickness. Viewing direction: between wheel and front suspension toward brake pads **1**.

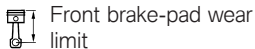

min 0.04 in (min 1.0 mm)
(Only friction material without carrier plate. Wear markings (grooves) must be clearly visible.)

If the wear indicators are no longer clearly visible:



Dropping below the minimum pad thickness.

Reduced braking action. Damage to the brake.

- In order to ensure the operating reliability of the brake system, make sure that the brake pads are not worn beyond their minimum thickness. ◀
- Have the brake pads replaced at an authorized service facility, preferably an authorized BMW Motorrad retailer.

Check rear brake pad thickness

- Make sure ground is level and firm and park motorcycle.

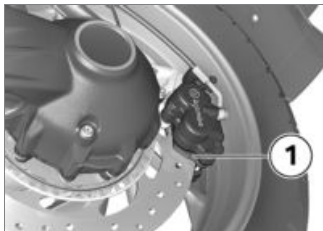

- Conduct a visual inspection of the brake pad thickness. Viewing direction: from below toward brake pads **1**.

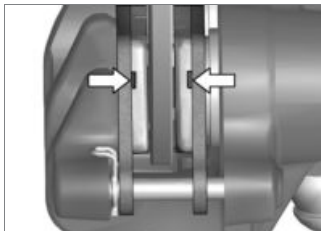

Rear brake-pad wear limit

min 0.04 in (min 1.0 mm)
(Only friction material without carrier plate. Do not permit wear to progress to the point at which the wear indicators (grooves) are reached.)

If the wear indicating mark is no longer visible:



WARNING

Dropping below the minimum pad thickness.

Reduced braking action. Damage to the brake.

- In order to ensure the operating reliability of the brake system, make sure that the brake pads are not worn beyond their minimum thickness. ◀
- Have the brake pads replaced at an authorized service facility, preferably an authorized BMW Motorrad dealer.

Checking front brake fluid level



WARNING

Insufficient brake fluid in the brake-fluid reservoir.

Considerably reduced braking performance caused by air in the brake system.

- Check brake fluid level regularly. ◀

- Make sure ground is level and firm and place motorcycle on its center stand.



- Check brake fluid level in front brake-fluid reservoir **1**.

NOTICE

The brake fluid level in the brake-fluid reservoir drops due to brake pad wear. The decreasing fluid level is compensated with an easy-to-see black rubber bellows.◀

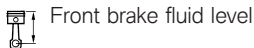

Front brake fluid level

Brake fluid, DOT4

The brake fluid level must not fall below the MIN mark. (Brake fluid reservoir horizontal, motorcycle standing upright and handlebars straight ahead.)

If brake fluid level falls below the approved level:

- Have the defect corrected as soon as possible by an authorized workshop, preferably an

authorized BMW Motorrad retailer.

If the lower edge of the black bellows in the brake-fluid reservoir is below the MAX graduation:

- Check front brake pad thickness (➔ 126).

Checking rear brake fluid level

WARNING

Insufficient brake fluid in the brake-fluid reservoir.

Considerably reduced braking performance caused by air in the brake system.

- Check brake fluid level regularly.◀
- Make sure ground is level and firm and place motorcycle on its center stand.



- Check level of brake fluid in rear brake-fluid reservoir **1**.

NOTICE

The brake fluid level in the brake-fluid reservoir drops due to brake pad wear. ◀



Rear brake fluid level

Brake fluid, DOT4

The brake fluid level must not fall below the MIN mark. (Brake-fluid reservoir horizontal, motorcycle standing upright.)

If brake fluid level falls below the approved level:

- Have the defect corrected as soon as possible by an authorized workshop, preferably an

authorized BMW Motorrad retailer.

Coolant

Check coolant level

- Make sure ground is level and firm and park motorcycle.
- Allow the engine to cool down.

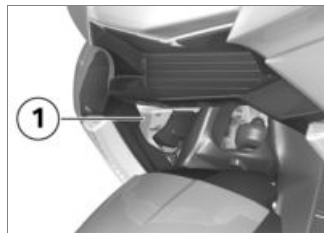

- Read off coolant level on expansion tank **1**.

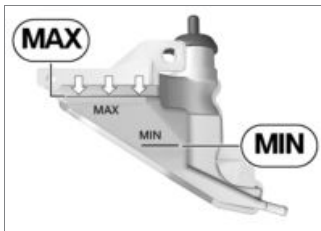

Coolant, specified level

between MIN and MAX marks on the expansion tank (with cold engine)

If coolant level drops below approved level:

- Have the defect corrected as soon as possible by an authorized workshop, preferably an authorized BMW Motorrad retailer.

Clutch

Check clutch function

- Pull back the clutch lever.
 - » Pressure point must be clearly perceptible.

If no clear pressure point can be felt:

- Have the clutch checked by an authorized workshop, preferably an authorized BMW Motorrad retailer.

Checking clutch fluid level

- Make sure ground is level and firm and place motorcycle on its center stand.
- Move handlebars into straight-ahead position.



- Read off clutch fluid level at reservoir **1**.



NOTICE

The fluid level in the clutch fluid reservoir rises due to clutch wear. ◀



Clutch fluid level (visual check)

Clutch fluid level must not drop.

If clutch fluid level drops:



ATTENTION

Use of unsuitable fluids.

Damage to the clutch system.

- No fluids may be poured in. ◀
- Have the defect corrected as soon as possible by an authorized workshop, preferably an authorized BMW Motorrad retailer.

Wheel rims and tires

Check wheel rims

- Make sure ground is level and firm and park motorcycle.
- Subject wheel rims to visual inspection for defects.
- Have damaged rims checked and, if necessary, replaced by a specialist service facility, preferably an authorized BMW Motorrad retailer.

Checking tire tread depth



WARNING

Riding with heavily worn tyres

Risk of accident due to poorer rideability

- If necessary, replace the tyres before the legally specified minimum tread depth is reached. ◀
- Make sure ground is level and firm and park motorcycle.
- Measure tire tread depth in main tread grooves with wear indicating marks.



NOTICE

Tread wear marks are integrated into the main grooves on every tire. If the tire tread has worn down to the level of the marks, the tire is completely worn. The locations of the marks are indicated on the edge of the tire, e.g.

by the letters TI, TWI or by an arrow. ◀

When the minimum tread depth is reached:

- Replace tires concerned.

Wheels

Tire recommendation

For every size of tire, BMW Motorrad has tested and approved certain makes as roadworthy. BMW Motorrad cannot evaluate the suitability of other tires, and can therefore take no responsibility for their driving safety.

BMW Motorrad recommends only using the tires tested and approved by BMW Motorrad. Extensive information is available at your authorized BMW Motorrad retailer or on the Internet at "www.bmw-motorrad.com".

Affect of wheel sizes on suspension control systems

The wheel sizes play a major role in the chassis control systems ABS and DTC. The diameter and width of the wheels stored in the control unit have particular significance as the basis for all necessary calculations. A change in these sizes resulting from conversion to wheels not installed as standard equipment can seriously affect the control efficiency of these systems.

The sensor rings required for wheel speed detection must also match the installed control systems and may not be replaced. If you want to equip your motorcycle with different wheels, please contact a specialist service facility, preferably a BMW Motorrad retailer. In some cases the data stored in the

control units can be adapted for the new wheel sizes.

TPC/RDC sticker

- with Tire Pressure Control (TPC/RDC)^{OE}

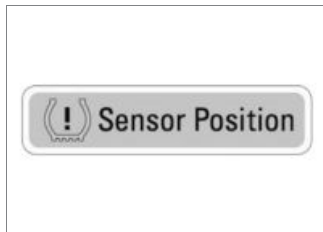

ATTENTION

Improper tire removal.

Damage to the TPC/RDC sensors.

- Inform a specialist service facility or an authorized BMW Motorrad retailer on the fact that the wheel is equipped with a TPC/RDC sensor. ◀

On motorcycles equipped with TPC/RDC, a corresponding sticker is located on the wheel rim at the position of the TPC/RDC sensor. During a tire change it must be ensured that the TPC/RDC sensor is not damaged. Inform the BMW Motorrad retailer or the authorized workshop of the TPC/RDC sensor.

Removing front wheel

- Make sure ground is level and firm and place motorcycle on its center stand.



- Remove screws **1** on left and right.
- Pull out front wheel cover toward front.



- Unclip retaining clip **1** holding the sensor cable to the brake line.

- Remove cable tie **2**.
- Mask off area of wheel rim that could be scratched in process of removing brake calipers.



ATTENTION

Pressing together the brake pads with the brake caliper removed.

The brake caliper cannot be mounted over the brake disc.

- Do not operate the brake lever with the brake caliper removed. ◀

- Remove screws **3** of brake calipers on left and right.

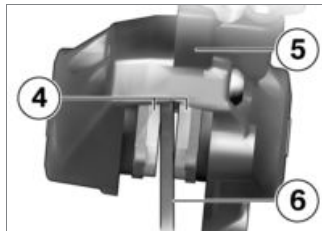

- Push brake pads **4** apart slightly by rocking brake caliper **5** back and forth against brake disk **6**.
- Carefully pull brake calipers back and out until clear of brake disks.

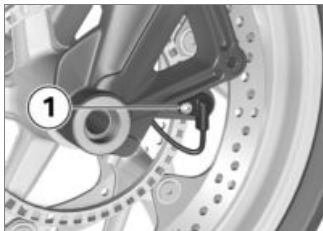

- Remove screw **1** and take wheel speed sensor out of bore.
- Raise front of motorcycle, preferably using a BMW Motorrad front wheel stand, continuing until the wheel rotates freely.
- Mounting front wheel stand (►► 139).

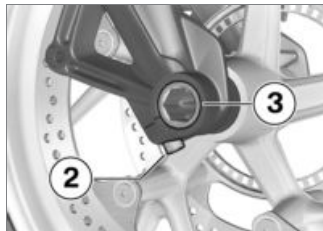

ATTENTION

Incorrect spacing between the sensor ring and wheel speed sensor caused by poorly aligned threaded bushing in the front suspension.

Damage to the wheel speed sensor. ABS malfunction.

- The left clamp fixes the threaded bushing in position and must not be loosened or removed.◀
- Remove right-hand axle clamping screw **2**.

- Remove quick-release axle **3** while supporting wheel.
- Roll front wheel forward to remove it.

Installing front wheel

WARNING

Use of a wheel which does not comply with series specifications.

Malfunctions during control interventions by ABS and DTC.

- Please see the information on the effect of wheel sizes on the ABS and DTC chassis control systems at the beginning of this chapter.◀

ATTENTION

Tightening of screwed connections with incorrect tightening torque.

Damage or loosening of screwed connections.

- Always have the tightening torques checked by a specialized workshop, preferably an authorized BMW Motorrad retailer. ◀



ATTENTION

Front wheel installation opposite the running direction.

Accident hazard

- Observe running direction arrows on tire or rim. ◀
- Roll front wheel into front wheel guide.

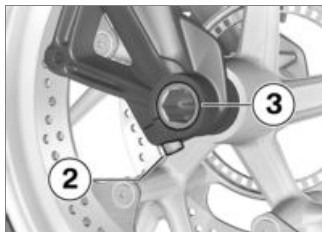

- Lift front wheel and install quick-release axle **3** with torque.



Quick-release axle in threaded bush (wheel carrier)

37 lb/ft (50 Nm)

- Tighten the right-hand axle clamping screw **2** with the specified torque.



Clamping screw for quick-release axle to wheel carrier

14 lb/ft (19 Nm)

- Remove front wheel stand.

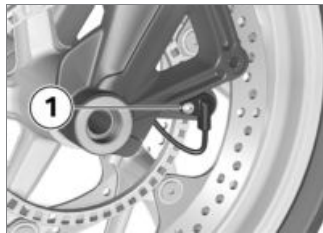

- Insert ABS sensor into hole and install screw **1**.
- Slide the brake calipers onto the brake rotors.



- Install securing screws **3** on left and right with specified torque.



Front brake caliper on wheel carrier

22 lb/ft (30 Nm)



- Clip on retaining clip **1** holding the sensor cable to the brake line.
- Secure new cable tie **2**.
- Remove adhesive tape from wheel rim.
- Press handbrake lever firmly a number of times until resistance point is noticeable.

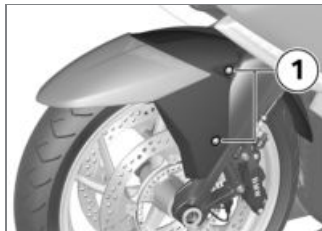

- Install front wheel cover and fit screws **1** on right and left.

Removing rear wheel

- Make sure ground is level and firm and place motorcycle on center stand.
- Remove case if necessary.

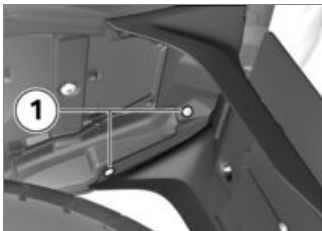

- Remove screws **1** on left and right.
- Remove the license-plate carrier.
- Shift into first gear.



CAUTION

Hot exhaust system.

Burn hazard

- Do not touch hot exhaust system. ◀
- Remove five screws **1** on rear wheel, holding wheel as you do so.
- Lower rear wheel to the ground and roll out toward rear.

Installing rear wheel

WARNING

Use of a wheel which does not comply with series specifications.

Malfunctions during control interventions by ABS and DTC.

- Please see the information on the effect of wheel sizes on the ABS and DTC chassis control systems at the beginning of this chapter. ◀

ATTENTION

Tightening of screwed connections with incorrect tightening torque.

Damage or loosening of screwed connections.

- Always have the tightening torques checked by a specialized workshop, preferably an authorized BMW Motorrad retailer. ◀

- Roll and mount rear wheel onto rear wheel support.



- Fit five screws **1** and tighten diagonally with specified torque.

 Tighten rear wheel on wheel flange

Tightening sequence: diagonally

44 lb/ft (60 Nm)

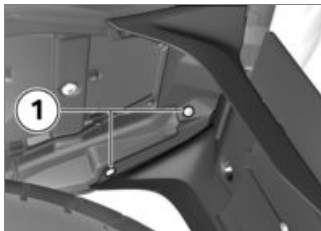

- Hold the license-plate carrier in position.
- Install screws **1** on left and right.

Front wheel stand Mounting front wheel stand



Use of the BMW Motorrad front wheel stand without an additional center or auxiliary stand.

Component damage caused by tipping over.

- Place the motorcycle on the center stand or an auxiliary stand before lifting it with the BMW Motorrad front wheel stand. ◀
- Use basic stand with part number (83 30 0 402 241) in combination with front-wheel adapter (83 30 0 402 243).
- Make sure ground is level and firm and place motorcycle on its center stand.



- Loosen locating screws **1**.

- Push two mounting pins **2** far enough apart that front suspension fits between them.
- Use locating pins **3** to set front wheel stand to desired height.
- Center front wheel stand relative to front wheel and push it against front axle.

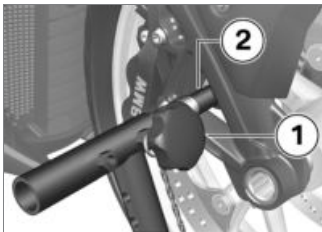

ATTENTION

The left mounting pin moves too much.

Damage to the sensor ring of the ABS integrated in the BMW Motorrad.

- Only push the left mounting pin so far inward that it does not touch the sensor ring.◀
- Push two mounting pins **2** through triangles of brake caliper support toward inside so that front wheel can still be rolled through.
- Tighten locating screws **1**.



ATTENTION

Lifting off of the main stand if the motorcycle is raised too high.

Component damage caused by tipping over.

- When raising the motorcycle, make sure that the center stand remains on the ground.◀
- Apply uniform pressure to push front wheel stand down and raise motorcycle.

Jump-starting



CAUTION

Touching live parts of the ignition system when the engine is running.

Electrocution

- Do not touch parts of the ignition system when the engine is running.◀



ATTENTION

Current too high when jump-starting the motorcycle

Cable fire or damage to the vehicle electronics

- Do not jump-start the motorcycle using the power socket, only via the battery terminal. ◀



ATTENTION

Contact between crocodile clips of jump leads and motorcycle.

Danger of short circuit

- Use jump leads fitted with fully insulated crocodile clips at both ends. ◀



ATTENTION

Jump-starting with a voltage higher than 12 V.

Damage to the motorcycle's electronics.

- The battery of the donor vehicle must have a voltage of 12 V. ◀

- Do not disconnect the battery from the onboard electrical system when jump-starting the engine.
- Remove the seat (▶▶▶ 120).
- Allow engine on support motorcycle to run while jump-starting.
- Begin by clamping one end of the red jumper cable to the positive terminal of the discharged battery and clamping the other end to the positive terminal of the donor battery.
- Then clamp one end of the black jumper cable to the donor battery's negative terminal while connecting the other end to discharged battery's negative terminal.
- Start engine of vehicle with discharged battery in usual way; if engine does not start, wait a few minutes before repeating attempt in order to protect

starter motor and donor battery.

- Allow both engines to idle for a few minutes before disconnecting jumper cables.
- Disconnect jumper lead from negative terminal first, then from positive terminal.
- Installing seat (▶▶▶ 122).

Light sources

Replace bulb for high-beam headlight



NOTICE

The description below steps you through the procedure for replacing the left bulb. Replacement is carried out in the same way on the right side. ◀

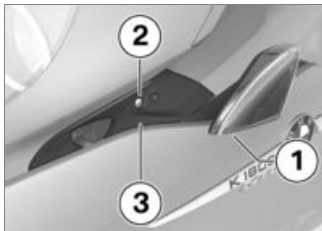

- Turn slipstream deflector **1** out.
- Remove screw **2** and work side cover **3** to the rear and remove.

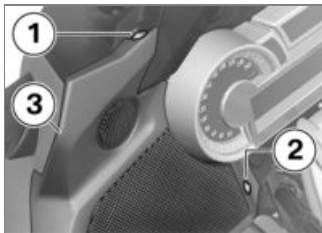

- Remove screw **1**.

- Switch on the ignition and raise the windscreen to its highest position.
- Remove screw **2** and work hand protector **3** to the side to remove.
- Switch off the ignition and wait until the windscreen has moved to its lowest position.

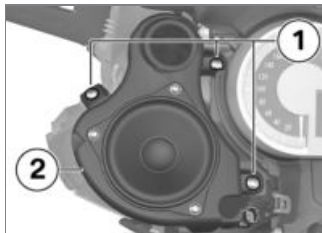

- Remove screws **1**.
- Work speaker unit **2** to the rear to remove.

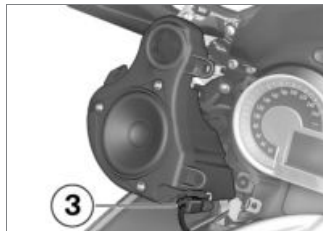

- Disconnect connector **3**.

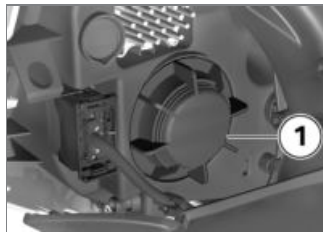

- Turn covers **1** counterclockwise to remove.



- Disconnect plug **2**.



- Release spring clip **3** at left and right and swing it up.
- Remove bulb **4**.

- Replace defective light source.

	Bulb for high-beam headlight
---	------------------------------

H7 / 12 V / 55 W

- To protect the glass against soiling, only grasp the light source by the base.



- Install bulb **4** while ensuring correct position of lug **5**.
- Insert spring clip **3**.



- Connect plug **2**.

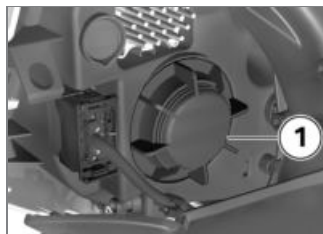

- Turn covers **1** clockwise to install.

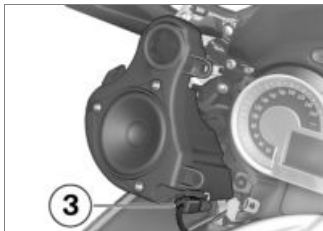

- Close plug connection **3**.

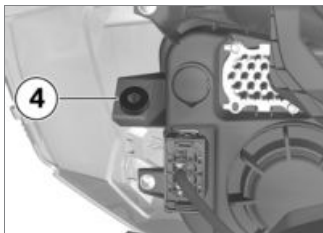

- Seat the speaker unit in mount **4**.



- Install screws **1**.
- Switch on the ignition and raise the windscreen to its highest position.

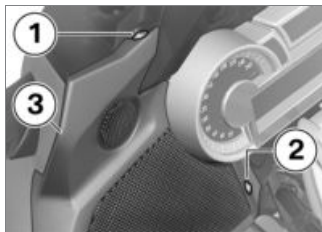

- Hold hand protector **3** in position and install screw **2**.

- Switch off the ignition and wait until the windscreen has moved to its lowest position.
- Install screw **1**.

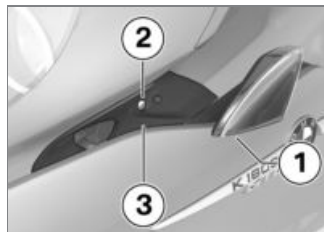

- Hold side cover **3** in position and install screw **2**.
- Align slipstream deflector **1**.

Replacing additional LED headlight

- with additional LED headlight^{OE}
- with additional LED headlight^{OA}

The additional LED headlights can only be completely replaced.

- Please contact a specialist service facility for this purpose, preferably an authorized BMW Motorrad retailer.

Replacing the LED turn indicator

LED turn indicators can be completely replaced only.

- Please contact a specialist service facility for this purpose, preferably an authorized BMW Motorrad retailer.

Replace LED tail light

The LED tail light can only be completely replaced.

- Please contact a specialist service facility for this purpose, preferably an authorized BMW Motorrad retailer.

Battery

Maintenance instructions

Correct battery maintenance combined with proper charging and storage procedures extends the battery's service life, and is also required for warranty claims. Compliance with the points below is important in order to maximize battery life:

- Keep the surface of the battery clean and dry.
- Do not open the battery.
- Do not top up with water.
- Be sure to read and comply with the instructions for charging the battery on the following pages.
- Do not turn the battery upside down.



ATTENTION

Discharging of the connected battery by the vehicle electronics (e.g. clock).

Total discharge of battery leading to a rejection of warranty claims.

- During riding breaks of more than 4 weeks, connect a trickle-charger to the battery. ◀



NOTICE

BMW Motorrad has developed a trickle-charger specially designed for compatibility with the electronics of your motorcycle. Using this charger, you can keep the battery charged during long periods when the motorcycle is not being used without having to disconnect the battery from the motorcycle's onboard systems. Additional information is available at your authorized BMW Motorrad retailer. ◀

Charge connected battery



ATTENTION

Charging of the connected battery on the battery terminals.

Damage to the motorcycle's electronics.

- Disconnect the battery before charging on the battery terminals.◀



ATTENTION

Charge a fully discharged battery via the power socket or additional socket.

Damage to the motorcycle's electronics.

- Always charge a fully discharged battery (battery voltage below 9 V; with the ignition switched on, the indicator lights and the multifunction display remain

off) directly at the poles of the **disconnected** battery.◀



ATTENTION

Unsuitable chargers connected to the power socket.

Damage to charger and chassis electronics.

- Use suitable BMW chargers. The correct charger is available through your authorized BMW Motorrad retailer.◀
- Charge disconnected battery via onboard socket.



NOTICE

The motorcycle's onboard electronics know when the battery is fully charged. The onboard socket is switched off when this happens.◀

- Comply with operating instructions of charger.



NOTICE

If you are unable to charge the battery via the onboard socket, you may be using a charger that is not compatible with your motorcycle's electronics. In this case, charge the battery directly at the terminals of the disconnected battery.◀

Charge disconnected battery

- Charge battery using a suitable charger.
- Comply with operating instructions of charger.
- Once the battery charging procedure is complete, disconnect the charger's terminal clips from the battery terminals.



NOTICE

In the case of longer periods when the motorcycle is not be-

ing used, the battery must be recharged regularly. See the instructions for caring for your battery. Always fully recharge the battery before returning it to use.◀

Remove battery

- Remove the seat (▶ 120).
– with anti-theft alarm system (DWA)^{OE}
- Switch off anti-theft alarm system if necessary.◀
- Switch off ignition.

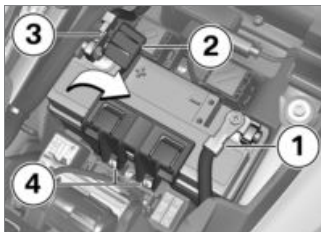

ATTENTION

Incorrect battery disconnection.

Danger of short circuit

- Follow the disconnection sequence.◀
- Remove negative battery cable **1**.
- Open cover **2** and remove positive battery cable **3**.
- Remove screws **4** and remove the retainer.
- Lift battery upwards; if it is difficult to move, moving it back and forth will help.

Installing battery

- Place battery in battery compartment, positive terminal on right in direction of travel.

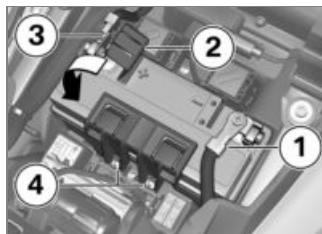

ATTENTION

Incorrect battery connection.

Danger of short circuit

- Follow the installation sequence.◀
- First connect battery positive lead **3** and close cover **2**.

- Then install negative battery cable **1**.
- Installing seat (▶▶▶ 122).
- Switch on ignition.
- Set the time in **Settings - Time** and set the date in **Settings - Date**.

Fuses

Replacing fuses

- Switch off ignition.
- Remove the seat (▶▶▶ 120).



ATTENTION

Bypassing defective fuses.

Risk of short circuit and fire.

- Replace defective fuses with new fuses.◀
- Consult the fuse assignment diagram and replace the defective fuse.



NOTICE

If the fuses blow frequently, have the electrical system checked by an authorized specialized workshop, preferably an authorized BMW Motorrad retailer.◀

- Installing seat (▶▶▶ 122).

Fuse assignments



- 1** 40 A
Motorcycle electronics

- 2** 40 A
Motorcycle electronics
– with Electronic Suspension Adjustment (ESA)^{OE}
ESA
- 3** 30 A
Electronic engine management
- 4** Fuse box
Numbering of the fuses as per label on lid of fuse box:
- 1** not in use
- 2** not in use
- 3** not in use
- 4** 4 A
Left handlebar fitting, top-case lighting
– with Tire Pressure Control (TPC/RDC)^{OE}
TPC/RDC
- 5** 7.5 A
Audio system

- 6** 4 A
Beam throw adjustment
 - with adaptive headlight^{OE}Adaptive cornering lights
- 7** 4 A
Main relay, instrument panel, ignition switch
- 8** not in use
 - with anti-theft alarm system (DWA)^{OE}7.5 A
Alarm system

Care

Care products	152
Washing your motorcycle	152
Cleaning sensitive motorcycle parts	153
Paint care	153
Store motorcycle	154
Protective wax coating	154
Returning motorcycle to use	154

Care products

BMW Motorrad recommends that you use cleaning and care products available at your authorized BMW Motorrad retailer. BMW CareProducts have been materials tested, laboratory tested, and field tested and provide optimum care and protection for the materials used in your vehicle.



ATTENTION

Use of unsuitable cleaning and care agents.

Damage to motorcycle parts.

- Do not use any solvents such as nitro thinners, cold cleaners, fuel or similar, and do not use cleaning agents that contain alcohol. ◀

Washing your motorcycle

BMW Motorrad recommends that you use BMW Insect Remover to soften and wash off insects and stubborn dirt from painted parts before washing the motorcycle.

To prevent stains, do not wash the motorcycle immediately after it has been exposed to bright sunlight and do not wash it in the sun.

Make sure that the motorcycle is washed frequently, especially during the winter months.

To remove road salt, clean the motorcycle with cold water immediately after completion of every trip.



WARNING

Damp brake disks and brake pads after washing the mo-

torcycle, after riding through water or in the rain.

Poorer braking action.

- Brake early until the brake rotors and brake pads are dry. ◀



ATTENTION

Increased effect of salt caused by warm water.

Corrosion

- Only use cold water to remove road salt. ◀



ATTENTION

Damage caused by high water pressure from high-pressure cleaners or steam-jet devices.

Corrosion or short-circuit, damage to seals, to hydraulic brake system, to the electrical system and the seat.

- Exercise caution when using high-pressure or steam-jet devices. ◀

Cleaning sensitive motorcycle parts

Plastics

ATTENTION

Use of unsuitable cleaning agents.

Damage to plastic surfaces.

- Do not use abrasive cleaners or cleaners containing alcohol or solvents.
- Do not use insect sponges or sponges with a hard surface. ◀

Fairings and Panels

Clean body panels with water and BMW plastic cleaner.

Windshields and lenses are manufactured of plastic

Clean off dirt and insects with a soft sponge and plenty of water.

NOTICE

Soften stubborn dirt and dead insects by covering the affected areas with a wet cloth. ◀

Chrome

Especially in the case of road salt, carefully clean chrome parts with plenty of water and BMW auto shampoo. Use chrome polish for additional treatment.

Radiator

Clean the radiator regularly to prevent overheating of the engine due to inadequate cooling. For example, use a garden hose with low water pressure.

ATTENTION

Radiator fins bend easily.

Damage to radiator fins.

- When cleaning, ensure that the cooler fins are not bent. ◀

Rubber

Treat rubber components with water or BMW rubber protection coating agent.

ATTENTION

Use of silicone sprays for care of rubber seals.

Damage to rubber seals.

- Do not use silicone sprays or care products that contain silicone. ◀

Paint care

Washing the vehicle regularly will help counteract the long-term effects of substances that damage the paint, especially if your ve-

hicle is ridden in areas with high air pollution or natural sources of dirt, e.g. tree resin or pollen.

At the same time, you should remove particularly aggressive materials immediately; otherwise changes in the paint and discoloration can occur. These include spilled fuel, oil, grease and brake fluid as well as bird droppings. BMW Car Polish and BMW Paint Cleaner are recommended for this procedure.

Contamination on the paint finish is particularly easy to see after the vehicle has been washed. Remove this type of soiling with cleaning naphtha or spirit on a clean cloth or cotton ball. BMW Motorrad recommends removing tar spots with BMW Tar Remover. Then add a protective wax coating to the paint at these locations.

Store motorcycle

- Clean the motorcycle.
- Completely fill the motorcycle's fuel tank.
- Remove battery (➡ 147).
- Spray the brake and clutch lever, and the center and side stand pivots with a suitable lubricant.
- Protect metal and chrome-plated parts with an acid-free grease (Vaseline).
- Store the motorcycle in a dry room, raising it to remove the weight from both front wheels (preferably using the front and rear-wheel stands offered by BMW Motorrad).

Protective wax coating

BMW Motorrad recommends that you apply BMW Car Wax or another wax containing carnauba or synthetic wax additives to protect the paintwork.

When water fails to form beads on the paint surface this indicates it is time to apply wax.

Returning motorcycle to use

- Remove the protective wax coating.
- Clean the motorcycle.
- Installing battery (➡ 147).
- Observe checklist (➡ 89).

Technical Data

Troubleshooting chart	156	Weights.....	168
Threaded fasteners	157	Performance data	168
Engine	158		
Fuel.....	159		
Engine oil	159		
Clutch	160		
Transmission	160		
Rear-wheel drive	161		
Suspension	161		
Brakes	162		
Wheels and tires	162		
Electrical system.....	164		
Anti-Theft Alarm System	166		
Frame	167		
Dimensions	167		

Troubleshooting chart

Engine does not start at all or is very difficult to start.

Possible cause	Remedy
Side stand is extended	Retract side stand.
Gear engaged and clutch not disengaged	Place transmission in neutral or disengage clutch.
No fuel in tank	Refueling procedure ( 96).
Battery drained	Charge battery.

Threaded fasteners

Front wheel	Value	Valid
Front brake caliper on wheel carrier		
M8 x 30 - 10.9	22 lb/ft (30 Nm)	
Clamping screw for quick-release axle to wheel carrier		
M8 x 30	14 lb/ft (19 Nm)	
Quick-release axle in threaded bush (wheel carrier)		
M24 x 1.5	37 lb/ft (50 Nm)	
Rear wheel	Value	Valid
Tighten rear wheel on wheel flange		
M10 x 1.25 x 40	diagonally	
	44 lb/ft (60 Nm)	
Shifting	Value	Valid
Eccentric, peg to shift lever		
M6 x 20	6 lb/ft (8 Nm)	

Engine

Engine number location	Crankcase, on right-hand side over engine oil filler neck
Engine design	Transverse straight-six four-stroke engine with four valves per cylinder and two overhead camshafts; liquid cooling, electronic fuel injection, integral six-speed cassette gearbox, dry-sump lubrication.
Displacement	1649 cc (1649 cm ³)
Cylinder bore	2.8 in (72 mm)
Piston stroke	2.7 in (67.5 mm)
Compression ratio	12.2:1
Rated output	160 hp (118 kW), at engine speed: 7750 min ⁻¹
– with power reduction ^{OE}	107 hp (79 kW), at engine speed: 7750 min ⁻¹
Torque	129 lb/ft (175 Nm), at engine speed: 5250 min ⁻¹
– with power reduction ^{OE}	111 lb/ft (150 Nm), at engine speed: 4750 min ⁻¹
Maximum engine speed	max 8500 min ⁻¹
Idle speed	900 ^{±50} min ⁻¹ , Engine at operating temperature

Fuel

Recommended fuel quality	Super unleaded (max. 10 % ethanol, E10) 89 AKI (95 ROZ/RON) 89 AKI
Usable fuel quantity	Approx. 7 gal (Approx. 26.5 l)
Reserve fuel quantity	Approx. 1.1 gal (Approx. 4 l)
Emission standard	EU 3

Engine oil

Engine oil, capacity	Approx. 1.2 gal (Approx. 4.5 l), with filter replacement
Specification	SAE 5W-40, API SL/JASO MA2, Additives (for instance, molybdenum-based substances) are prohibited, because they would attack the coatings on engine components, BMW Motorrad recommends BMW Motorrad ADVANTEC Ultimate Oil

BMW recommends **ADVANTEC**
ORIGINAL BMW ENGINE OIL

Clutch

Clutch design	Multi-disk oil-bath clutch
---------------	----------------------------

Transmission

Transmission design	Claw-shifted 6-speed transmission integrated in engine housing
Transmission gear ratios	1.617, Primary gear ratio 1.941 (33:17 teeth), 1st gear 1.428 (30:21 teeth), 2nd gear 1.148 (31:27 teeth), 3rd gear 0.958 (23:24 teeth), 4th gear 0.806 (25:31 teeth), 5th gear 0.686 (24:35 teeth), 6th gear 0.913 (21:23 teeth), Angle drive 1.258 (39:31 teeth), Countershaft

Rear-wheel drive

Type of final drive	Shaft drive with bevel gears
Type of rear suspension	Cast-aluminum single swing arm with BMW Motorrad paralever
Number of teeth in bevel gears (gear ratio)	2.75 (33:12)

Suspension

Front wheel

Type of front suspension	BMW Motorrad Duolever
Design of the front-wheel suspension	Central suspension strut
– with Electronic Suspension Adjustment (ESA) ^{OE}	Central suspension strut with electrically adjustable damping.
Spring travel, front	4.9 in (125 mm), on wheel

Rear wheel

Type of rear suspension	Central suspension strut pivoted to lever system. Spring preload and rebound-stage damping steplessly adjustable.
– with Electronic Suspension Adjustment (ESA) ^{OE}	Central suspension strut pivoted to lever system. Electrically adjustable damping and spring preload/spring rate.
Spring travel, rear	5.3 in (135 mm), on wheel

Brakes

Type of front brake	Hydraulically operated twin disk brake with 4-piston fixed calipers and floating brake disks
Brake-pad material, front	Sintered metal
Front brake-disk thickness	min 0.18 in (min 4.5 mm), Wear limit
Type of rear brake	Hydraulic disk brake with 2-piston floating caliper and fixed brake disk
Brake-pad material, rear	Organic
Rear brake-disk thickness	min 0.19 in (min 4.9 mm), Wear limit

Wheels and tires

Recommended tire combinations	An overview of the current tire approvals is available from your authorized BMW Motorrad retailer or on the Internet at bmw-motorrad.com .
Speed category of front/rear tires	W, minimum requirement: 168 mph (270 km/h)

Front wheel

Front wheel design	Cast aluminum, MT H2
Front-wheel rim size	3.50" x 17"
Front tire designation	120 / 70 ZR 17
Load index for front tire	At least 58
Permissible front-wheel imbalance	max 0.2 oz (max 5 g)

Rear wheel

Rear wheel design	Cast aluminum, MT H2
Rear-wheel rim size	6.00" x 17"
Rear tire designation	190 / 55 ZR 17
Load index for rear tire	At least 75
Permissible rear-wheel imbalance	max 1.6 oz (max 45 g)

Tire inflation pressure

Tire pressure, front	42.1 psi (2.9 bar), with tire cold
Tire pressure, rear	42.1 psi (2.9 bar), with tire cold

Electrical system

Electrical rating of onboard sockets	max 10 A, all onboard sockets together
Battery	
Battery design	Gel battery
Battery voltage	12 V
Battery capacity	19 Ah
Spark plugs	
Spark plugs, manufacturer and designation	NGK LMAR8AI-8
Electrode gap of spark plug	0.03 in (0.8 mm), New 0.04 in (1.0 mm), Wear limit
Bulbs	
Bulb for high-beam headlight	H7 / 12 V / 55 W
Bulbs for low-beam headlight	D1S / 35 W
Bulb for parking light	Lighting rings, integrated into headlight
Bulb for taillight/brake light	LED
Bulbs for flashing turn indicators, front	LED
Bulbs for flashing turn indicators, rear	LED

Fuses	
Fuse carrier 1	30 A, Engine electronics
Fuse carrier 2	40 A, Slot left: Vehicle electronics 40 A, Slot right: Vehicle electronics, ESA
Fuse box	not in use, Slot 1 not in use, Slot 2 not in use, Slot 3 4 A, Slot 4: Left handlebar fitting, tire pressure monitoring (RDC), topcase interior light 7.5 A, Slot 5: Audio system 4 A, Slot 6: Beam throw control, Adaptive Headlight 4 A, Slot 7: Main relay, instrument cluster, ignition switch 7.5 A, Slot 8: Anti-theft alarm (DWA), central locking

Anti-Theft Alarm System

– with anti-theft alarm system (DWA)^{OE}

Anti-theft alarm

Activation time	30 s
Alarm duration	26 s
Activation time between two alarms	10 s
Battery type	CR 123 A

Remote control

Range of remote control	32.8 ft (10 m)
Signal frequency	25 kHz, Broadband
Transmission frequency	433.92 MHz
Battery design and nominal battery voltage (for remote control)	CR 1632 lithium 3 V

Frame

Frame design	Cast light alloy - welded design with screwed-on light alloy rear frame
Location of type plate	Wheel carrier, front right
Location of the vehicle identification number	Frame side section, front right (beside engine-oil filler neck)

Dimensions

Motorcycle length	98 in (2490 mm), over topcase
Motorcycle height	57.7 in (1465 mm), across windshield at DIN unladen weight
Motorcycle width	39.4 in (1000 mm), across mirrors 38.6 in (980 mm), without mirrors
Rider's seat height	29.5 in (750 mm), without driver
– with high seat ^{OE}	30.7 in (780 mm), without driver
Rider's inside-leg arc, heel to heel	67.7 in (1720 mm), without driver
– with high seat ^{OE}	69.7 in (1770 mm), without driver

Weights

Unladen weight	767 lbs (348 kg), DIN unladen weight, with cases and topcase, ready for road, 90 % load of fuel, without optional extras
Permissible gross weight	1235 lbs (560 kg)
Maximum payload	467 lbs (212 kg)

Performance data

Start-off capacity on uphill grades (with permissible total weight)	20 %
Top speed	>124 mph (>200 km/h)

Service

Reporting safety defects	170
BMW Motorrad Service	171
BMW Motorrad Mobility Services	171
Maintenance procedures	171
Maintenance schedule	175
Standard BMW Service	176
Confirmation of maintenance work	177
Confirmation of service	182

Reporting safety defects

If you believe that your vehicle has a defect which could cause a crash or could cause injury or death, you should immediately inform the National Highway Traffic Safety Administration (NHTSA) in addition to notifying BMW of North America, LLC.

If NHTSA receives similar complaints, it may open an investigation, and if it finds that a safety defect exists in a group of vehicles, it may order a recall and remedy campaign. However, NHTSA cannot become involved in individual problems between you, your retailer, or BMW of North America, LLC.

To contact NHTSA, you may call the Vehicle Safety Hotline toll-free at 1-888-327-4236 (teletypewriter TTY for the deaf: 1-800-424-9153); go to the website <http://www.safercar.gov>; or write to: Administrator, NHTSA, 400 Seventh Street, SW., Washington, DC 20590. You can also obtain other information about motor vehicle safety from <http://www.safercar.gov>.

BMW Motorrad Service

With its worldwide service network, BMW Motorrad can attend to you and your motorcycle in over 100 countries around the globe. BMW Motorrad retailers have the technical information and expertise needed to conduct reliable service and repairs covering every aspect of your BMW. You can find the nearest authorized BMW Motorrad retailer by visiting our Internet site at "www.bmw-motorrad.com".

WARNING

Improperly performed maintenance and repair work.

Accident hazard due to subsequent damage.

- BMW Motorrad recommends having corresponding work on your motorcycle carried out by a specialized workshop,

preferably by an authorized BMW Motorrad retailer. ◀

To ensure that your BMW consistently remains in optimal condition BMW Motorrad urges you to observe the recommended service intervals.

Have all maintenance and repair work confirmed in the "Service" chapter in this manual. For generous treatment of claims submitted after the warranty period has expired (goodwill), evidence of regular maintenance is essential.

You can obtain information on the contents of the BMW Services from your BMW Motorrad retailer.

BMW Motorrad Mobility Services

The BMW Motorrad Mobility Services furnish you and your new BMW motorcycle with extra security by offering a wide array of assistance services in the event of a breakdown (BMW Roadside Assistance, breakdown assistance, vehicle recovery and retrieval, etc.).

Contact your authorized BMW Motorrad retailer for additional information on available mobility-maintenance services.

Maintenance procedures

BMW Pre-Delivery Check

The BMW pre-delivery check is carried out by your authorized BMW Motorrad retailer before it turns over the vehicle to you.

BMW Running-in Check

The BMW running-in check must be carried out between 300 mls (500 km) and 750 mls (1200 km).

BMW Service

BMW Service is carried out once a year. The scope of the services performed may be dependent on the motorcycle owner and the mileage driven. Your BMW Motorrad retailer confirms that the service has been performed and enters the date for the next service.

For riders who drive long distances annually, it may be necessary to come in for service before the entered date. In this case a corresponding maximum odometer reading will also be entered in the confirmation of service. If this odometer reading is reached before the next service date, service must be performed sooner.

The service display in the multi-function display reminds you of the next service date approx. one month or 621 miles (1000 km) before the entered values.

More information on the topic of service is available at:

bmw-motorrad.com/service

The required scope of maintenance work for your motorcycle can be found in the following maintenance plan:

Maintenance schedule

- 1** BMW running-in check
- 2** Standard BMW Service
( 176)
- 3** Engine oil change with filter
- 4** Replacing air cleaner insert
- 5** Check valve clearance
- 6** Replace all spark plugs
- 7** Oil change in rear bevel gear
- 8** Change the brake fluid in the entire system
 - a** annually or every 6000 miles (whichever comes first)
 - b** annually or every 12000 miles (whichever comes first)
 - c** for the first time after one year, then every two years

Standard BMW Service

The standard BMW Service includes the following maintenance work:

- Performing the brief test using the BMW Motorrad diagnosis system.
- Drain the oil condensate hose.
- Visual inspection of brake lines, brake hoses and connections.
- Checking the front/rear brake fluid level.
- Checking the front/rear brake pads and brake discs for wear.
- Check the clutch system.
- Checking the coolant level.
- Checking the tyre pressure and tread depth.
- Checking the side stands for ease of movement.
- Checking the center stand for ease of movement.
- Checking the lighting and signal system.
- Checking that the engine starting suppression works.
- Final inspection and checking for road safety.
- Setting the service date and remaining distance to service.
- Checking the battery state of charge.
- Recording the BMW Service in the on-board literature.

Confirmation of maintenance work

BMW Pre-Delivery Check

Conducted

on _____

Stamp, Signature

BMW Running-in Check

Conducted

on _____

Odometer reading _____

Next service
at the latest

on _____

or, if reached sooner,

Odometer reading _____

Stamp, Signature

BMW Service

Conducted

on _____

Odometer reading _____

Next service
at the latest

on _____

or, if reached sooner,

Odometer reading _____

Stamp, Signature**BMW Service**

Conducted

on _____

Odometer reading _____

Next service
at the latest

on _____

or, if reached sooner,

Odometer reading _____

Stamp, Signature**BMW Service**

Conducted

on _____

Odometer reading _____

Next service
at the latest

on _____

or, if reached sooner,

Odometer reading _____

Stamp, Signature

BMW Service

Conducted

on _____

Odometer reading _____

Next service
at the latest

on _____

or, if reached sooner,

Odometer reading _____

Stamp, Signature**BMW Service**

Conducted

on _____

Odometer reading _____

Next service
at the latest

on _____

or, if reached sooner,

Odometer reading _____

Stamp, Signature**BMW Service**

Conducted

on _____

Odometer reading _____

Next service
at the latest

on _____

or, if reached sooner,

Odometer reading _____

Stamp, Signature

BMW Service

Conducted

on _____

Odometer reading _____

Next service
at the latest

on _____

or, if reached sooner,

Odometer reading _____

Stamp, Signature**BMW Service**

Conducted

on _____

Odometer reading _____

Next service
at the latest

on _____

or, if reached sooner,

Odometer reading _____

Stamp, Signature**BMW Service**

Conducted

on _____

Odometer reading _____

Next service
at the latest

on _____

or, if reached sooner,

Odometer reading _____

Stamp, Signature

BMW Service

Conducted

on _____

Odometer reading _____

Next service
at the latest

on _____

or, if reached sooner,

Odometer reading _____

Stamp, Signature**BMW Service**

Conducted

on _____

Odometer reading _____

Next service
at the latest

on _____

or, if reached sooner,

Odometer reading _____

Stamp, Signature**BMW Service**

Conducted

on _____

Odometer reading _____

Next service
at the latest

on _____

or, if reached sooner,

Odometer reading _____

Stamp, Signature

Confirmation of service

The table is intended as proof of maintenance and repair work, the installed optional accessories and any special campaign (recall) work carried out.

Work carried out	Odometer reading	Date

Work carried out	Odometer reading	Date

Appendix

Certificate for Electronic Immobilizer	186
Certificate for Remote Key.....	188
Certificate for Keyless Ride	192
Certificate for Tire Pressure Control	194

FCC Approval

Ring aerial in the ignition switch



To verify the authorization of the ignition key, the electronic immobilizer exchanges information with the ignition key via the ring aerial.

This device complies with Part 15 of the FCC rules. Operation is subject to the following two conditions:

- (1) This device may not cause harmful interference, and
- (2) this device must accept any interference received, including interference that may cause undesired operation.



Any changes or modifications not expressly approved by the party responsible for compliance could void the user's authority to operate the equipment. ◀

Approbation de la FCC

Antenne annulaire présente dans le commutateur d'allumage



Pour vérifier l'autorisation de la clé de contact, le système d'immobilisation électronique échange des

informations avec la clé de contact via l'antenne annulaire.

Le présent dispositif est conforme à la partie 15 des règles de la FCC. Son utilisation est soumise aux deux conditions suivantes :

- (1) Le dispositif ne doit pas produire d'interférences nuisibles, et
- (2) le dispositif doit pouvoir accepter toutes les interférences extérieures, y compris celles qui pourraient provoquer une activation inopportune.



Toute modification qui n'aurait pas été approuvée expressément par l'organisme responsable de l'homologation peut annuler l'autorisation accordée à l'utilisateur pour utiliser le dispositif. ◀

Certifications

Remote Control for central locking system



Česky

Meta System S.p.A. tímto prohlašuje, že tento PF240009 je ve shodě se základními požadavky a dalšími příslušnými ustanoveními směrnice 1999/5/ES.

Dansk

Undertegnede Meta System S.p.A. erklærer herved, at følgende udstyr PF240009 overholder de væsentlige krav og øvrige relevante krav i direktiv 1999/5/EF.

Deutsch

Hiermit erklärt Meta System S.p.A., dass sich das Gerät PF240009 in Übereinstimmung mit den grundlegenden Anforderungen und den übrigen einschlägigen Bestimmungen der Richtlinie 1999/5/EG befindet.

Eesti

Käesolevaga kinnitab Meta System S.p.A. seadme PF240009 vastavust direktiivi 1999/5/EÜ põhinõuetele ja nimetatud direktiivist tulenevatele teistele asjakohastele sätetele.

English

Hereby, Meta System S.p.A., declares that this PF240009 is in compliance with the essential requirements and other relevant provisions of Directive 1999/5/EC.

Español

Por medio de la presente Meta System S.p.A. declara que el PF240009 cumple con los requisitos esenciales y cualesquiera otras disposiciones aplicables o exigibles de la Directiva 1999/5/CE.

Certifications

Ελληνική

ΜΕ ΤΗΝ ΠΑΡΟΥΣΑ Meta System S.p.A. ΔΗΛΩΝΕΙ ΟΤΙ PF240009 ΣΥΜΜΟΡΦΩΝΕΤΑΙ ΠΡΟΣ ΤΙΣ ΟΥΣΙΩΔΕΙΣ ΑΠΑΙΤΗΣΕΙΣ ΚΑΙ ΤΙΣ ΛΟΙΠΕΣ ΣΧΕΤΙΚΕΣ ΔΙΑΤΑΞΕΙΣ ΤΗΣ ΟΔΗΓΙΑΣ 1999/5/ΕΚ.

Français

Par la présente Meta System S.p.A. déclare que l'appareil PF240009 est conforme aux exigences essentielles et aux autres dispositions pertinentes de la directive 1999/5/CE.

Italiano

Con la presente Meta System S.p.A. dichiara che questo PF240009 è conforme ai requisiti essenziali ed alle altre disposizioni pertinenti stabilite dalla direttiva 1999/5/CE.

Latviski

Ar šo Meta System S.p.A. deklarē, ka PF240009 atbilst Direktīvas 1999/5/ΕΚ būtiskajām prasībām un citiem ar to saistītajiem noteikumiem.

Lietuvių

Šiuo Meta System S.p.A. deklaruoja, kad šis PF240009 atitinka esminius reikalavimus ir kitas 1999/5/EB Direktyvos nuostatas.

Nederlands

Hierbij verklaart Meta System S.p.A. dat het toestel PF240009 in overeenstemming is met de essentiële eisen en de andere relevante bepalingen van richtlijn 1999/5/EG.

Malti

Hawnhekk, Meta System S.p.A., jiddikjara li dan PF240009 jikkonforma mal-ħtiġijiet essenzjali u ma provvedimenti oħrajn relevanti li hemm fid-Dirrettiva 1999/5/EC.

Magyar

Alulírott, Meta System S.p.A. nyilatkozom, hogy a PF240009 megfelel a vonatkozó alapvető követelményeknek és az 1999/5/EC irányelv egyéb előírásainak.

Polski

Niniejszym Meta System S.p.A. oświadcza, że PF240009 jest zgodny z zasadniczymi wymogami oraz pozostałymi stosownymi postanowieniami Dyrektywy 1999/5/EC.

Português

Meta System S.p.A. declara que este PF240009 está conforme com os requisitos essenciais e outras disposições da Directiva 1999/5/CE.

Certifications

Slovensko

Meta System S.p.A. izjavlja, da je ta PF240009 v skladu z bistvenimi zahtevami in ostalimi relevantnimi določili direktive 1999/5/ES.

Slovensky

Meta System S.p.A. týmto vyhlasuje, že PF240009 spĺňa základné požiadavky a všetky príslušné ustanovenia Smernice 1999/5/ES.

Suomi

Meta System S.p.A. vakuuttaa täten että PF240009 tyyppinen laite on direktiivin 1999/5/EY oleellisten vaatimusten ja sitä koskevien direktiivin muiden ehtojen mukainen.

Svenska

Härmed intygar Meta System S.p.A. att denna PF240009 står i överensstämmelse med de väsentliga egenskapskrav och övriga relevanta bestämmelser som framgår av direktiv 1999/5/EG.

Íslenska

Hér með lýsir Meta System S.p.A. yfir því að PF240009 er í samræmi við grunnkröfur og aðrar kröfur, sem gerðar eru í tilskipun 1999/5/EC.

Norsk

Meta System S.p.A. erklærer herved at utstyret PF240009 er i samsvar med de grunnleggende krav og øvrige relevante krav i direktiv 1999/5/EF.

USA, Canada

Product name: TX BMW MR FCC ID: P3O98400 IC:4429A - TXBMWMR

This device complies with Part 15 of the FCC rules. Operation is subject to the following two conditions:

- (1) This device may not cause harmful interference, and
- (2) this device must accept any interference received, including interference that may cause undesired operation.



Any changes or modifications not expressly approved by the party responsible for compliance could void the user's authority to operate the equipment.

Declaration Of Conformity

R&TTE Declaration Of Conformity (DoC)

CE0470

We:

Meta System S.p.A.

with the address:

Via Majakovskij 10 b/c/d/e
42124 Reggio Emilia -Italy

Declare

Under own responsibility that the product:

TX BMW MR

To which this declaration relates is in conformity with the essential requirements and other relevant requirements of the R&TTE Directive (1999/5/EC).

This product is in conformity with the following standards:

Health & Safety (art.3.1)

EN 60950-1

EMC (art.3.2)

ETSI EN 301 489-1/-3

Spectrum

ETSI EN 300 220 - 2

Human exposure

EN 62311

According to Directive 1999/5/CE

Reggio Emilia , 14/07/2010

Technical Director
Lasagni Cesare



Certifications

BMW Keyless Ride ID Device



USA, Canada

Product name: BMW Keyless Ride ID Device
FCC ID: YGOHUF5750
IC: 4008C-HUF5750

Canada:

Operation is subject to the following two conditions:

- (1) This device may not cause harmful interference, and
- (2) this device must accept any interference received, including interference that may cause undesired operation.

USA:

This device complies with Part 15 of the FCC rules. Operation is subject to the following two conditions:

- (1) This device may not cause harmful interference, and
- (2) this device must accept any interference received, including interference that may cause undesired operation.



Any changes or modifications not expressly approved by the party responsible for compliance could void the user's authority to operate the equipment.

Declaration Of Conformity

We declare under our responsibility that the product

BMW Keyless Ride ID Device (Model: HUF5750)

complies with the appropriate essential requirements of the article 3 of the R&TIE and the other relevant provisions, when used for its intended purpose. Applied Standards:

1. Health and safety requirements contained in article 3 (1) a)
 - EN 60950-1:2006+A11:2009+A1:2010+A12:2011; Information technology equipment- Safety
2. Protection requirements with respect to electromagnetic compatibility article 3 (1) b)
 - EN 301 489-1 (V1 .9.2, 09/2011), Electromagnetic compatibility and radio spectrum matters (ERM); Electromagnetic compatibility (EMC) standard for radio equipment and services; Part 1: Common technical requirements
 - EN 301 489-3 (V1.4.1, 08/2002) Electromagnetic compatibility and radio spectrum matters (ERM); Electromagnetic compatibility (EMC) standard for radio equipment and services; Part 3: Specific conditions for short range devices (SRD) operating on frequencies between 9 kHz and 40 GHz
3. Means of the efficient use of the radio frequency spectrum article 3 (2)
 - EN 300 220-1 & -2 (V2.4.1, 05/2012), electromagnetic compatibility and radio spectrum matters (ERM); Short range devices (SRD); Radio equipment to be used in the 25 MHz to 1000 MHz frequency range with power levels ranging up to 500 mW;
Part 1: Technical characteristics and test methods.
Part 2: Harmonized EN covering essential requirements under article 3.2 of the R&TIE directive

The product is labeled with the CE marking: **CE**

Velbert, October 15th, 2013

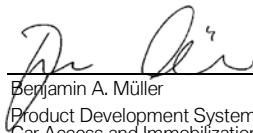

Benjamin A. Müller
Product Development Systems
Car Access and Immobilization – Electronics
Huf Hüsbeck & Fürst GmbH & Co. KG
Steeger Straße 17, D-42551 Velbert

Certification Tire Pressure Control (TPC)

FCC ID: MRXBC54MA4
IC: 2546A-BC54MA4

FCC ID: MRXBC5A4
IC: 2546A-BC5A4

This device complies with Part 15 of the FCC Rules and with Industry Canada license-exempt RSS standard(s).

Operation is subject to the following two conditions:

- (1) This device may not cause harmful interference, and
- (2) This device must accept any interference received, including interference that may cause undesired operation.

Le présent appareil est conforme aux CNR d'Industrie Canada applicables aux appareils radio exempts de licence. L'exploitation est autorisée aux deux conditions suivantes:

- (1) l'appareil ne doit pas produire de brouillage, et
- (2) l'utilisateur de l'appareil doit accepter tout brouillage radioélectrique subi, même si le brouillage est susceptible d'en compromettre le fonctionnement.

WARNING: Changes or modifications not expressly approved by the party responsible for compliance could void the user's authority to operate the equipment. The term "IC:" before the radio certification number only signifies that Industry Canada technical specifications were met.

A

Abbreviations and symbols, 6

ABS

- Self-diagnosis, 91
- Technology in detail, 103
- Warning indicators, 38

Accessories

- General instructions, 112

Ambient temperature

- Display, 22
- Outside temperature warning, 37

Anti-theft alarm system

- Operating, 80
- Warning indicator, 41

Auxiliary headlight

- Operating, 59

Average values

- Resetting, 56

B

Battery

- Charge connected battery, 146
- Charging disconnected battery, 146
- Installing, 147

Maintenance instructions, 145

Position on motorcycle, 17

Removing, 147

Technical data, 164

Warning for battery charge current, 35

Warning for battery voltage low, 36

Brake fluid

Checking fluid level at rear, 129

Checking front fluid level, 128

Front reservoir, 13

Rear reservoir, 13

Brake pads

Checking front, 126

Checking rear, 127

Running in, 93

Brakes

ABS Pro in detail, 106

ABS Pro, 94

Adjusting handlebar lever, 72

Checking operation, 126

Safety instructions, 93

Technical Data, 162

Breaking in, 92

Bulbs

Replace bulb for high-beam headlight, 141

Replace LED tail light, 145

Replacing additional LED headlight, 144

Replacing the LED turn indicator, 145

Technical data, 164

Warning for bulb failure, 37

C

Case

- Operating, 116

Central locking

- Operating, 76
- Warning indicator for central locking, 42

Checklist, 89

Clock

- Adjusting, 54

Clutch

- Adjusting handlebar lever, 71
- Checking fluid level, 131
- Checking operation, 131
- Fluid reservoir, 11

Technical Data, 160
Confirmation of maintenance work, 177
Coolant
 Checking level, 130
 Fluid level indicator, 13
 Overtemperature warning indicator, 34
Cruise-control system
 Control, 14
 Operating, 68

D
Damping
 Adjusting, 74
 Rear adjuster, 11
Date
 Adjusting, 54
Dimensions
 Technical Data, 167
DTC
 Control, 14
 Operating, 64
 Self-diagnosis, 92
 Technology in detail, 107
 Warning indicator, 38

DWA
 Indicator light, 18

E
Electrical system
 Technical Data, 164
Emergency on/off switch (kill switch), 16
 Operating, 61
Engine
 Starting, 90
 Technical Data, 158
 Warning for engine electronics, 34
Engine oil
 Check fill level, 124
 Fill location, 13
 Oil dipstick, 13
 Oil level indicator, 23
 Technical Data, 159
 Topping up, 126
 Warning for engine oil level, 35
Equipment, 7

ESA
 Control, 14
 Operating, 75
 Technology in detail, 109

F
Frame
 Technical Data, 167
Front wheel stand
 Mounting, 139
Fuel
 Fill location, 11
 Refueling, 96
 refueling with Keyless Ride, 97, 98
 Technical Data, 159
Fuel reserve
 Range, 22
 Warning indicator, 34
Fuses
 Position on motorcycle, 17
 Replacing, 148
 Technical Data, 164

G

- Ground lighting
- Operating, 59

H

- Hazard warning flashers
 - Control, 14
 - Operating, 60
- Headlight
 - Adjusting for traffic driving on right/driving on left, 58
 - Headlamp range adjustment, 11
 - Warning indicator for LHD/RHD traffic, 41
 - Warning indicator for unknown position, 41
- Heated handlebar grips
 - Operating, 61
- Hill Start Control
 - Operating, 70
 - Technology in detail, 103
- Horn, 14

I

- Ignition
 - Switching off, 46
 - Switching on, 45
- Immobilizer
 - Emergency key, 46, 48
 - Warning indicator, 33
- Indicator lights, 18
 - Overview, 26
- Instrument cluster
 - Ambient light photosensor, 18
 - Overview, 18

J

- Jump-starting, 140

K

- Keyless Ride
 - Battery of radio-operated key is completely drained or radio-operated key has been lost, 49
 - EWS Electronic immobilizer, 48
 - Locking handlebars, 47
 - Switch off ignition, 48
 - Switch on ignition, 47
 - Unlocking fuel filler cap, 97, 98

- Warning indicator, 33
- Keys, 45, 46

L

- Lights
 - Control, 14
 - Headlight low beam, 57
 - Operating headlight flasher, 57
 - Operating headlight high beams, 57
 - Operating parking light, 58
 - Parking lights, 57
- Luggage
 - Loading information, 88

M

- Maintenance
 - General instructions, 124
 - Maintenance schedule, 175
- Maintenance intervals, 171
- Mirrors
 - Adjusting, 73
- Mobility Services, 171
- Motorcycle
 - Care, 151
 - Cleaning, 151

- Parking, 95
- Returning to use, 154
- Storage, 154
- Tying down, 99
- Multifunction display, 18
 - Control, 14
 - Meaning of symbols, 21
 - Operating, 51
 - Overview, 20
 - Settings, 54
- Multifunction switch
 - General view, left, 14
 - General view, right, 16

N

- Navigation devices
 - Installing, 113
 - Operating, 115
 - Removing, 114
- Notice concerning current status, 7

O

- Onboard computer
 - Operating, 55

- Onboard power socket
 - Information on use, 112
 - Position on vehicle, 13
- Onboard tool kit
 - Contents, 124
 - Position on motorcycle, 17
- Overview of warning indicators, 28
- Overviews
 - Instrument cluster, 18
 - Left side of vehicle, 11
 - Left-side multifunction switch, 14
 - Multifunction display, 20
 - Right side of vehicle, 13
 - Right-hand multifunction switch, 16
 - Underneath seat, 17
 - Warning and indicator lights, 26

P

- Pre-Ride-Check, 91

R

- RDC
 - Display, 23
 - Rim sticker, 133
 - Technology in detail, 108
 - Warning indicators, 39
- Rear-wheel drive
 - Technical Data, 161
- Refueling, 96
 - with Keyless Ride, 97, 98
- Remote control
 - logging on, 78
 - Replacing battery, 50, 80
 - synchronize, 79
- Rider's Manual (US Model)
 - Position on motorcycle, 17
- Riding mode
 - Adjusting, 64
 - Technology in detail, 102

S

- Safety instructions
 - On braking, 93
 - On riding, 88

- Seat
 - Installing, 66
 - Locking mechanism, 11
 - Removing, 66
- Seat heating
 - Control, 11
 - Operating, 62
- Service, 171
 - Reporting safety defects, 170
 - Warning indicator, 42
- Service display, 24
- Shift lever
 - Adjusting, 72
- Spark plugs
 - Technical data, 164
- Speedometer, 18
- Spring preload
 - Adjusting, 73
 - Rear adjuster, 11
- Starting, 90
 - Control, 16
- Steering lock
 - Locking, 45

- Storage compartment
 - Operating, 71
 - Position on vehicle, 11, 13
- Suspension
 - Technical Data, 161
- Switching off, 95
- Symbols
 - Meaning, 21

T

- Tachometer, 18
- Technical data
 - Battery, 164
 - Brakes, 162
 - Bulbs, 164
 - Clutch, 160
 - Dimensions, 167
 - Electrical system, 164
 - Engine, 158
 - Engine oil, 159
 - Frame, 167
 - Fuel, 159
 - Rear-wheel drive, 161
 - Spark plugs, 164
 - Standards, 7

- Suspension, 161
- Transmission, 160
- Weights, 168
- Wheels and tires, 162
- Tires
 - Checking tire inflation pressures, 84
 - Checking tread depth, 132
 - Inflation pressure table, 17
 - Inflation pressures, 163
 - Recommendation, 132
 - Running in, 93
 - Technical Data, 162
- Topcase
 - Operating, 119
- Torques, 157
- Transmission
 - Technical Data, 160
- Trip distance recorder
 - Operating, 57
- Troubleshooting chart, 156
- Turn indicators
 - Control, 14
 - Operating, 60

Type plate
Position on vehicle, 13

V

Vehicle identification number
Position on vehicle, 13

W

Warning lamps, 18
ABS, 38
Anti-theft alarm, 41
Battery charge current, 35
Bulb defective, 37
Central locking, 42
Coolant temperature, 34
Display, 27
DTC, 38
Electronic immobilizer, 33
Engine electronics, 34
Engine oil level, 35
Fuel reserve, 34
Headlight for LHD/RHD
traffic, 41
Headlight in unknown
position, 41

Outside temperature
warning, 37
Overview, 26
Service, 42
Tire Pressure Monitor, 39
Undervoltage, 36

Weights

Payload table, 17
Technical Data, 168

Wheels

Check wheel rims, 132
Installing front wheel, 135
Installing rear wheel, 138
Removing front wheel, 133
Removing rear wheel, 137
Size change, 133
Technical Data, 162

Wind deflection wing, 67

Windshield

Adjusting, 67
Control, 14

The descriptions and illustrations in this manual may vary from your own motorcycle's actual equipment, depending upon its equipment level and accessories as well as your specific national version. No claims stemming from these differences can be recognized.

Dimensions, weights, fuel consumption and performance data are quoted to the customary tolerances.

The right to modify designs, equipment and accessories is reserved.

Errors and omissions excepted.

© 2015 Bayerische Motoren Werke Aktiengesellschaft
80788 Munich, Germany
Reprints and duplication of this work, in whole or part, are prohibited without the express written approval of BMW Motorrad, Aftersales.

Original Rider's Manual, printed in Germany.

Important data for refueling:

Fuel	
Recommended fuel quality	Super unleaded (max. 10 % ethanol, E10) 89 AKI (95 ROZ/RON) 89 AKI
Usable fuel quantity	Approx. 7 gal (Approx. 26.5 l)
Reserve fuel quantity	Approx. 1.1 gal (Approx. 4 l)
Tire inflation pressure	
Tire pressure, front	42.1 psi (2.9 bar), with tire cold
Tire pressure, rear	42.1 psi (2.9 bar), With tire cold

You'll find additional information on all aspects of your motorcycle at:
bmw-motorrad.com

BMW recommends **ADVANTEC**
ORIGINAL BMW ENGINE OIL

Order No.: 01 41 8 522 707
08.2015, 7th edition, 07

