

Rider's Manual

K 1200 S



BMW Motorrad



Welcome to BMW

We congratulate you on choosing a BMW motorcycle and welcome you to the community of BMW riders.

Familiarise yourself with your new motorcycle so that you can ride it safely and confidently in all traffic situations. Please read this Rider's Manual carefully before starting to use your new BMW motorcycle. It contains important information on how to operate the controls and how to make the best possible use of all your BMW's technical features. In addition, it contains information on maintenance and care to help you maintain your motorcycle's reliability and safety, as well as its value.

If you have any questions concerning your motorcycle, your authorised BMW motorcycle dealer will gladly provide advice and assistance.

We hope you enjoy reading this Rider's Manual and wish you many a pleasant, safe journey on your BMW motorcycle.

Best wishes,

BMW Motorrad

Table of contents

Use the index (▶▶ 149) to find a certain topic quickly.

Welcome to BMW	1
General information	4
Overview	7
General view, left side	9
General view, right side	11
Left handlebar controls	12
Right handlebar controls	13
Instrument cluster	14
Headlights	15
Status indicators	17
Multifunction display	18
Warning and telltale lights	18
Warning indicators	19
ABS warning indicators	25

Operation	29
Ignition switch and steering lock	30
Electronic immobiliser ...	31
Hazard warning flashers	32
Tripmaster	33
Kill switch	34
Grip heating ^{OE}	35
Clock	35
Handlebar levers	36
Lights	37
Turn indicators	39
Seat	40
Helmet holder	41
Luggage loops	42
Mirrors	43
Spring preload	43
Shock absorbers	44
ESA ^{OE}	45
Wheels	47
Riding	49
Safety instructions	50
Safety check	52

Making your first trip	52
Before you start	53
Starting	56
Riding	58
Running in	58
Shifting gear	59
Placing the motorcycle on its side stand	61
Taking the motorcycle off the side stand	63
Placing the motorcycle on the centre stand ^{OA}	65
Pushing the motorcycle off the centre stand ^{OA}	67
Fuel	67
Brake system	68
Accessories	73
General instructions	74
Power socket	74
Luggage system	77
Breakdown assistance kit for tubeless tyres	82

Maintenance 83

Toolkit	85
Engine oil	86
Coolant	88
Brakes.....	89
Clutch	93
Wheels	94
Front-wheel stand	103
Rear wheel stand	104
Bulbs.....	105
Jump starting	111
Battery	112
Splash guard.....	116

Care 117

Cleaning and care	118
Laying up	120
Restoring to use.....	121

Technical data 123

Bolt connections	124
Tyre pressures	126
Engine.....	127
Power transmission.....	128
Frame and suspension.....	129

Wheels and tyres	131
Fuel and lubricants	132
Electrical system.....	135
Dimensions and weights	137
Riding specifications ...	138

Service 139

BMW Motorrad service	140
Confirmation of maintenance work	143
Confirmation of service	147

Index 149

General information

About this Rider's Manual

We have tried to make all the information in this Rider's Manual easy to find. The quickest access to a particular topic or item is by consulting the detailed index (» 149). The first chapter of this Rider's Manual will provide you with an initial overview of your motorcycle. When the time comes to sell your BMW, please remember to hand over this Rider's Manual; it is an important part of your motorcycle.

Symbols and abbreviations



Indicates warnings that you must comply with for reasons of safety, the safety of others and to protect your motorcycle against damage.



Special information on operating and inspecting your motorcycle as well as maintenance and adjustment procedures.

- ◀ Indicates the end of an item of information.
- Instruction.
- » Result of an activity.

(» 4) Reference to a page with more detailed information.

OE Optional extras you have chosen are taken into account during production of your motorcycle.

OA Optional accessories can be purchased and retrofitted at your authorised BMW motorcycle dealer.

EWS Electronic immobiliser.

ESA Electronic Suspension Adjustment.

DWA Anti-theft alarm system.

ABS Anti-lock braking system.

Custom equipment

When you ordered your BMW motorcycle, you chose various items of custom equipment. This Rider's Manual describes optional extras (OE) offered by BMW and selected optional accessories (OA). This explains why the manual may also contain descriptions of equipment which you have not ordered. Country-specific deviations from the motorcycle illustrated are also possible.

If your BMW contains equipment which is not described in this Rider's Manual, this will be described in separate operating instructions.

Technical data

All dimensions, weights and power ratings stated in the Rider's Manual are quoted to the standards and comply with the tolerance requirements of the Deutsche Institut für Normung e. V. (DIN). Versions for individual countries may differ.

Currency

The high safety and quality standards of BMW motorcycles are maintained by constant development work on designs, equipment and accessories. Because of this, your motorcycle may differ from the information supplied in the Rider's Manual. Nor can errors and omissions be entirely ruled out. We hope you will appreciate that no claims can be entertained on the basis of the data, illustrations or descriptions in this manual.

BMW Service

Advanced technology requires specially adapted methods of maintenance and repair.

 Incorrectly executed maintenance and repair work could result in subsequent damage and the safety risks associated with this.

BMW recommends that all appropriate work on your motorcycle be carried out by an authorised BMW motorcycle dealer or by a workshop which operates with appropriately trained personnel in accordance with BMW specifications. ◀

Your authorised BMW motorcycle dealer can provide information on the Service, Inspection and Annual Inspection needed, or you can obtain

the information from the Internet by visiting "www.bmw-motorrad.com/maintenance".

Have all maintenance and repair work carried out confirmed in the chapter "Service" (▶▶ 140) in this manual.

Your authorised BMW motorcycle dealer is supplied with all the latest technical information and therefore possesses the necessary technical know-how.

We therefore recommend that you consult your authorised BMW motorcycle dealer for all questions concerning the motorcycle.

Rider's equipment

Do not ride without the correct clothing. Always wear:







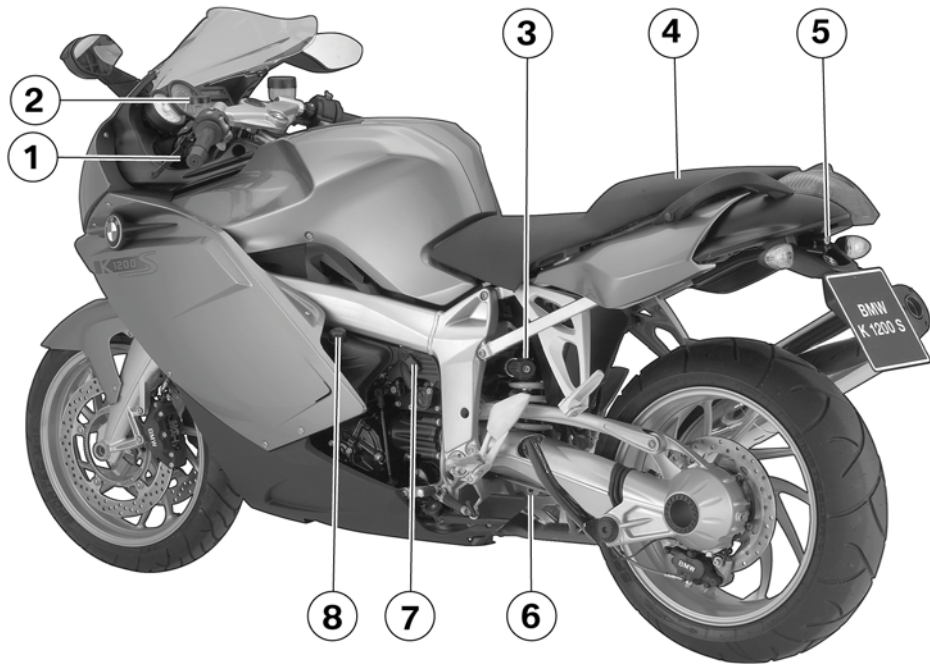

- a helmet
- a rider's suit
- gloves
- boots

This also applies to short journeys and throughout the year. Your authorised BMW motorcycle dealer will be glad to advise you on the correct clothing for every purpose.

General view, left side	9
General view, right side.....	11
Left handlebar controls	12
Right handlebar controls	13
Instrument cluster.....	14
Headlights.....	15



General view, left side

- 1** Vertical aim adjustment
( 38) beneath instrument cluster
- 2** Clutch fluid reservoir
( 93)
- 3** Adjusting the rear spring preload ( 43)
- 4** Helmet holder ( 41) under seat
- 5** Seat lock ( 40) beneath rear light
- 6** Rear shock absorber adjustment ( 44)
- 7** Power socket ( 74)
- 8** Coolant filler aperture
( 88)

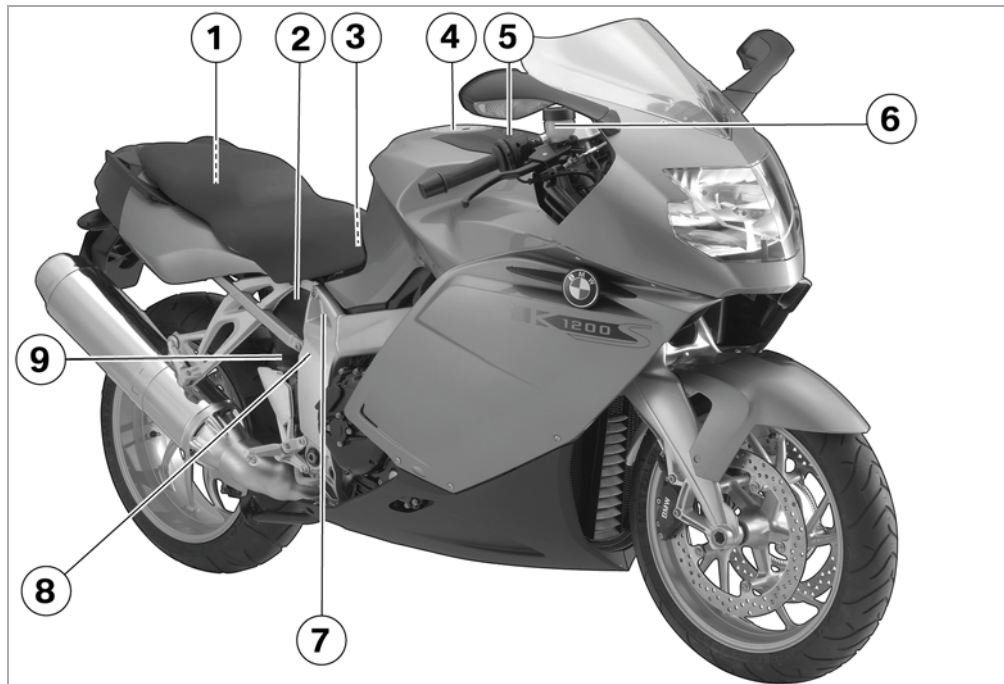

General view, right side

- 1 Toolkit (➡ 85) under the seat
- 2 Display for engine oil level (➡ 86)
- 3 Filler aperture
Engine oil (➡ 87), under seat
- 4 Filler aperture, fuel tank (➡ 67)
- 5 Battery compartment (➡ 115)
- 6 Front brake-fluid reservoir (➡ 91)
- 7 Type plate on rear cross pipe
- 8 Vehicle identification number on front right side panel
- 9 Rear brake-fluid reservoir (➡ 92)

Left handlebar controls

- 1 Button for Tripmaster (➡ 33)
- 2 Button for hazard warning flashers (➡ 32)
- 3 Button for ESA^{OA} (➡ 45)
- 4 Button for horn
- 5 Button for left turn indicator (➡ 39)
- 6 Switch for high-beam headlight and headlight flasher (➡ 37)

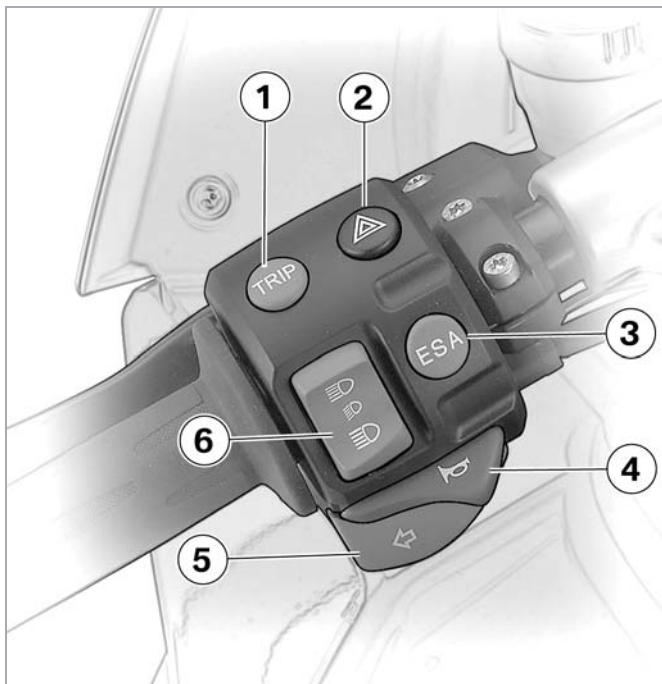

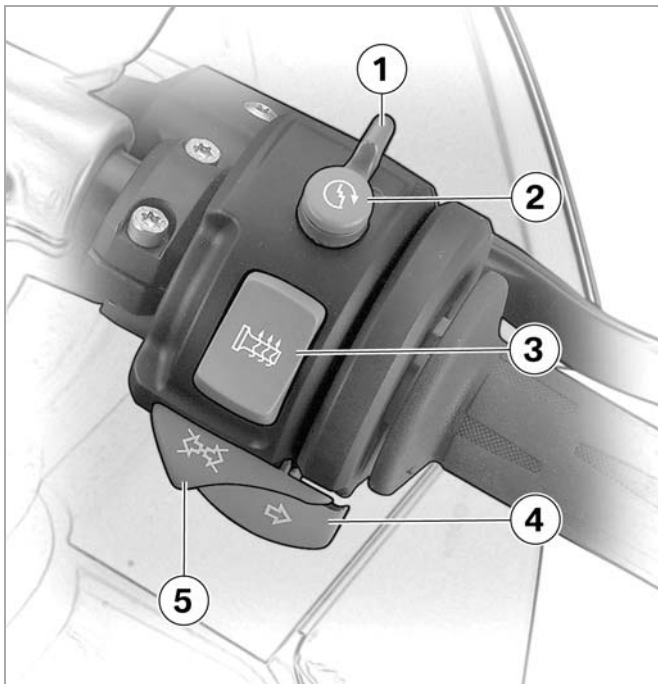

Right handlebar controls

- 1 Kill switch (➡ 34)
- 2 Starter button
- 3 Switch for grip heating^{OE} (➡ 35)
- 4 Button for right turn indicator (➡ 39)
- 5 Button to switch turn indicator off (➡ 40)

Instrument cluster

- 1 Rev. counter
- 2 Speedometer
- 3 Warning and telltale lights (➡ 18)
- 4 Multifunction display (➡ 18)
- 5 Telltale light DWA^{OE} and sensor for instrument cluster lighting
- 6 Clock adjustment (➡ 35)

 The instrument cluster lighting is equipped with an automatic day and night switchover. ◀

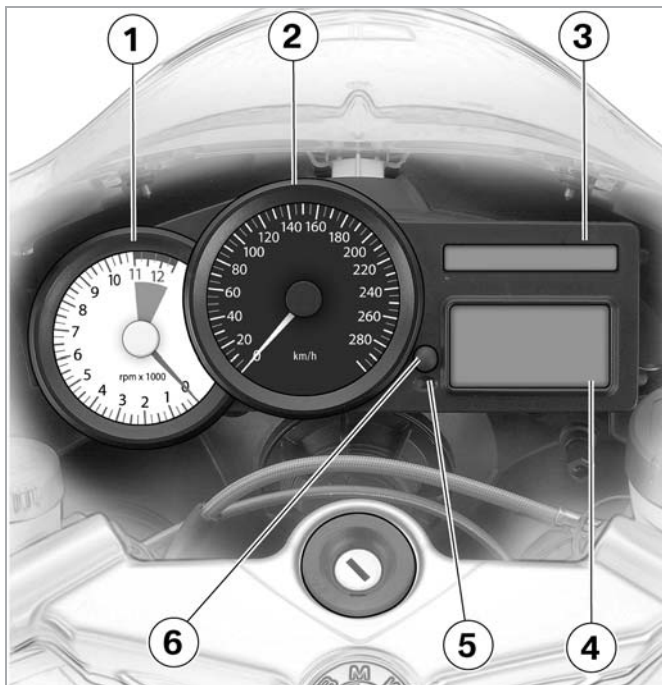

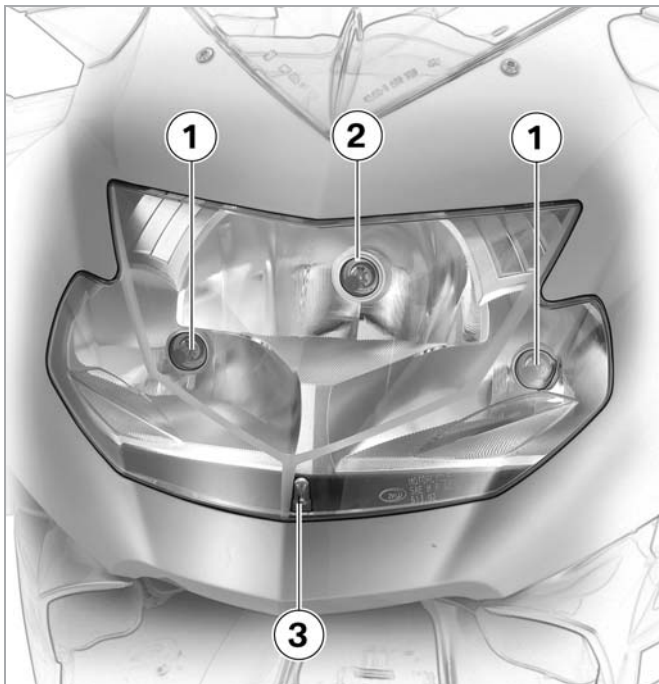

Headlights

- 1 High-beam headlight
- 2 Low-beam headlight
- 3 Parking light

Multifunction display.....	18
Warning and telltale lights.....	18
Warning indicators	19
ABS warning indicators	25

Multifunction display

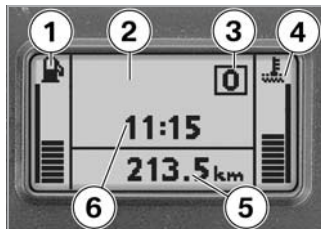

- 1 Fuel gauge
- 2 Display area for warning symbols
- 3 Gear indicator
- 4 Coolant temperature display
- 5 Tripmaster display (➡ 33)
- 6 Clock

Fuel capacity



The horizontal bars indicate the level in the fuel tank. If only four bars are displayed, the reserve fuel has been reached.

Gear indicator



The gear indicator displays the engaged gear. If no gear is engaged, the gear indicator displays 0; the 'neutral' telltale light also lights up.

Coolant temperature



The horizontal bars indicate the level of the coolant temperature.

Warning and telltale lights

The warning and telltale lights are shown in one of the following three variants depending on the country:



-  Telltale light, left turn indicator
-  Telltale light, high-beam headlight
-  Warning light, general
-  Telltale light, neutral



ABS warning light,
national-market
specification 1



ABS warning light,
national-market
specification 2



ABS warning light,
national-market
specification 3















Telltale light, right turn
indicator

























Warning indicators

Warnings are displayed by means of symbols in the multi-function display. In some cases, an additional general warning light lights up red or yellow. A number of warnings may be issued simultaneously.

Overview

The following table lists the possible warnings and pages with additional information.

Light	Symbol	Meaning	Explanations
		Ignition key not authorised.	(→ 22)
		Low-beam headlight, high-beam headlight, parking light or turn signal lamp defective.	(→ 24)
		Defective lamp.	(→ 24)
 yellow		Fuel reserve reached.	(→ 22)
 yellow		Fault in engine electronics.	(→ 23)
 yellow		Rear light or brake light lamp defective.	(→ 24)
 red		Coolant temperature too high.	(→ 22)
 red		Engine oil pressure too low.	(→ 23)

Light	Symbol	Meaning	Explanations
 red		Battery is no longer being charged.	( 24)
 red		Brake switch defective.	( 25)
	 1 flash per second	ABS starting-off test not completed.	( 25)
	 4 flashes per second	ABS self-diagnosis not completed.	( 26)
 red		Relay for ABS warning light defective.	( 26)
 red	 1 flash per second	ABS function not available.	( 26)
 red	 4 flashes per second	ABS in residual braking function.	( 27)
 1 red flash per second	 1 flash per second	Insufficient brake fluid.	( 27)
 4 red flashes per second	 4 flashes per second	A number of ABS faults.	( 28)

Electronic immobiliser (EWS)

 EWS symbol is displayed.

The key being used is not authorised for starting, or communication between the key and engine electronics is disrupted.

- Remove any other vehicle keys located near the ignition key (➡ 30).
- Use the replacement key.
- It is best to have the defective key replaced by an authorised BMW motorcycle dealer (➡ 32).

Fuel reserve

 General warning light lights up yellow.

 Fuel reserve symbol is displayed and flashes 10 times.

The fuel tank contains a fuel reserve of a maximum of 4 litres. The Tripmaster indicates the estimated residual operating range (➡ 34).

 Lack of fuel could result in the engine cutting out unexpectedly and this could therefore cause a dangerous road situation.

Do not run the fuel tank dry. ◀

 A lack of fuel could result in misfiring and this in turn could damage the catalytic converter.

Do not run the fuel tank dry. ◀

- Refuel.

Coolant temperature

 General warning light lights up red.

 Coolant temperature indicator flashes 10 times.

Coolant temperature too high.

 Continuing to ride when the engine is overheated could result in engine damage. It is essential that the measures given below are observed. ◀

- Check coolant level, top up if necessary.
- If possible, ride in the part-load range to cool down the engine.
- In traffic jams, switch off the engine, but keep the ignition on so that the radiator fan continues to operate.

Engine electronics



General warning light lights up yellow.



Engine electronics symbol is displayed.

Fault in the engine electronics. In exceptional cases, the engine stops and can no longer be started. Otherwise, the engine runs in emergency operating mode.

You can continue to ride, but bear in mind that the usual engine output is not available.

- Have the fault remedied as soon as possible by a specialist workshop, preferably an authorised BMW motorcycle dealer.

Engine oil pressure



General warning light lights up red.



Engine oil pressure symbol is displayed.

Insufficient engine oil pressure. The "engine oil pressure" warning indicates that there is no oil pressure or that the oil pressure in the lubricating oil circuit is too low; under no circumstances is it to be regarded as fulfilling the function of an oil gauge. Once the oil pressure has built up 1 – 2 seconds after the engine start, the warning indicator must go out.

If the "engine oil pressure" warning is displayed while the motorcycle is being ridden, take account of the traffic situation and:

- Disengage the gear.
- Press the kill switch.
- Bring the motorcycle safely to a halt.
- Check the engine oil level.





Alongside an insufficient engine oil level, other problems in the engine can lead to the "engine oil pressure" warning. Continuing to ride in these cases can cause engine damage.

If the "engine oil pressure" warning is issued, do not continue to ride, even though the engine oil level might be correct. ◀

- Have the fault remedied by a specialist workshop, preferably an authorised BMW motorcycle dealer.

Battery charge current

 General warning light lights up red.

 Battery charge current symbol is displayed.

The battery is no longer being charged. You can only continue to ride until the battery is discharged.

 A discharged battery could result in the engine cutting out unexpectedly and this could therefore cause a dangerous road situation. If possible, do not continue to ride. ◀

- Have the fault remedied as soon as possible by a specialist workshop, preferably an authorised BMW motorcycle dealer.

Defective lamp

 In the event of a lamp failure, there can be problems seeing and being seen. Defective lamps should be replaced as soon as possible. ◀

 General warning light lights up yellow.

 Defective lamp symbol with arrow pointing to the rear is displayed.

Rear light or brake light lamp defective.

- Replace bulbs (➡ 108).

 Defective lamp symbol with arrow pointing to the front is displayed.

Low-beam headlight, high-beam headlight, parking light or turn indicator defective.

- Replace bulbs (➡ 106-110).

 Defective lamp symbol with two arrows is displayed.

A combination of the lamp defects described previously has occurred.

- Replace bulbs (➡ 106-110).

ABS warning indicators

The ABS warning light is shown in one of the following three variants depending on the country:

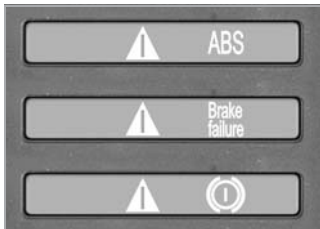

ABS warnings are indicated by a combination of the general warning light and the ABS warning light. Both warning lights can light up continuously or flash once or 4 times per second.

General warning light

 General warning light lights up red.

Brake switch defective or incorrectly adjusted. BMW Integral ABS detects the driver's request for braking by the pressure build-up from the brake lever. There may be an unusual response from the brake. You can continue to ride. However, bear in mind that the brake may respond in a manner to which you are not accustomed.

 There is a defect in the brake system that can lead to abnormal braking efficiency. Brake carefully and safely. Avoid braking sharply. ◀

- Have the fault remedied as soon as possible by a specialist workshop, preferably an authorised BMW motorcycle dealer.

ABS warning light

 ABS warning light flashes once per second.

ABS function not available as starting-off test (➔ 58) is not complete.

You can continue to ride. To prevent the wheels from locking:

- Do not use emergency braking until the starting-off test has been completed.
-  Without the ABS function, the wheels could lock under braking. Brake carefully and safely. Avoid braking sharply. ◀

 ABS warning light flashes 4 times per second.

Only residual braking function available in both brake circuits, as self-diagnosis (➡ 54) not complete.

You can continue to ride. However, bear in mind that neither the ABS function nor the braking power assistance is available before the self-diagnosis has been completed.

 Without the ABS function, wheels could lock under braking; without braking power assistance, considerably greater force is required to brake.

Brake carefully and safely. Avoid braking sharply. ◀

- When circumstances permit, avoid pressing the brake lever until the self-diagnosis has been completed.

General warning light and ABS warning light

 General warning light lights up red.

 ABS warning light lights up.

The relay for control of the ABS warning indicators is defective. No ABS faults can be displayed.

You can continue to ride, but bear in mind that any ABS faults that might occur can no longer be displayed.

 ABS warning display does not function. Brake carefully and safely. Avoid braking sharply. ◀

- Have the fault remedied as soon as possible by a specialist workshop, preferably an authorised BMW motorcycle dealer.

 General warning light lights up red.

 ABS warning light flashes once per second.

ABS function (➡ 71) unavailable in at least one brake circuit.

You can continue to ride. However, bear in mind that the ABS function is not available.

 Without the ABS function, the wheels could lock under braking. Brake carefully and safely. Avoid braking sharply. ◀

- Have the fault remedied as soon as possible by a specialist workshop, preferably an authorised BMW motorcycle dealer.

 General warning light lights up red.

 ABS warning light flashes 4 times per second.

Only residual braking function (➡ 71) still available in at least one brake circuit.

You can continue to ride.

However, bear in mind that neither the ABS function nor the braking power assistance is available.

 Without the ABS function, the wheels could lock under braking; without braking power assistance, considerably greater force is required to brake. Brake carefully and safely. Avoid braking sharply. ◀

- Have the fault remedied as soon as possible by a specialist workshop, preferably an authorised BMW motorcycle dealer.

 General warning light flashes red once per second.

 ABS warning light flashes once per second.

Fluid level in BMW Integral ABS too low.

 This means the fluid level for a wheel brake circuit cannot be read from the brake-fluid reservoirs. ◀

Among other things, the trigger for this warning indicator can be extremely worn brake pads.

 Worn brake pads can considerably lengthen the braking distance. Brake carefully and safely. Avoid braking sharply. ◀

 Worn brake pads can damage the brake discs. Brake carefully and safely. Avoid braking sharply. ◀

- Stop and check the thickness of the brake pads (► 90- 91).
- Have worn brake pads replaced as soon as possible by a specialist workshop, preferably an authorised BMW motorcycle dealer.

If the brake pad thickness is sufficient:

- Check the following functions:
 - Ignition off, brake pressure present at the brake levers.
 - Brakes acting on both wheels.
 - Brake system leaktight, no signs of brake fluid escaping.

If the functions are not shown:



There is a defect in the brake system.

Do not continue to ride. ◀

If these functions are in order, you can continue riding. However, bear in mind that a loss of brake fluid that cannot be detected might be the cause of the warning.



There is a fault in the brake system that can lead to decreased braking efficiency.

Brake carefully and safely. Avoid braking sharply. ◀

- Have the fault remedied as soon as possible by a specialist workshop, preferably an authorised BMW motorcycle dealer.



General warning light flashes red 4 times per second.



ABS warning light flashes 4 times per second.

There are two faults:

- Only residual braking function (► 71) available in at least one brake circuit, indicated by the general warning light lighting up and the ABS warning light flashing 4 times per second.
- Fluid level in the BMW Integral ABS is too low, indicated by the general and ABS warning lights flashing once per second.

Please read the fault descriptions listed later in this manual.

Ignition switch and steering lock	30
Electronic immobiliser.....	31
Hazard warning flashers.....	32
Tripmaster.....	33
Kill switch.....	34
Grip heating ^{OE}	35
Clock	35
Handlebar levers	36
Lights.....	37
Turn indicators	39
Seat	40
Helmet holder	41
Luggage loops.....	42
Mirrors.....	43
Spring preload	43

Shock absorbers	44
ESA ^{OE}	45
Wheels.....	47

Ignition switch and steering lock

Keys

You will receive one master key and one spare key. If a key is lost, please note the information on the EWS electronic immobiliser (► 22).

 Ignition switch and steering lock, tank filler cap lock and seat lock are all operated with the same key. System cases^{OA} can also be operated on request using the same key. ◀

Switching on the ignition



- Turn the key to position ○.
 - » Parking light and all function circuits switched on.
 - » Pre-ride check is carried out (► 53).
 - » ABS self-diagnosis is performed (► 54).
 - » Engine can be started.

Switching off the ignition





- Turn the key to position ⊗.
 - » Light switched off.
 - » Steering lock unsecured.
 - » In this position, you can remove the key.

Securing the steering lock



- Turn the handlebars to the full left or right lock position.
- Turn the key to position  OFF, while moving the handlebars slightly.
 - » Ignition, light and all function circuits switched off.
 - » Steering lock secured.
 - » In this position, you can remove the key.

 If the motorcycle is on the side stand, the surface of the ground will determine whether it is better to turn the handlebars to the left or right. On level ground, a secure stance is only ensured with the handlebars turned to the left. On level ground, always turn the handlebars to the left to set the steering lock. ◀

 With the ignition switched off, the braking power assistance is unavailable. While the motorcycle is being ridden, do not switch off the ignition. ◀

Electronic immobiliser

The electronic immobiliser helps protect your BMW motorcycle from theft, and this enhanced security is at your disposal without any need for you to set parameters or activate additional systems. The engine of a motorcycle fitted with this electronic immobiliser can only be started with the keys that belong to the vehicle. You can also have your authorised BMW motorcycle dealer bar individual keys, for example if a particular key goes missing. The engine cannot be started with a key that has been barred.

In-key security

An electronic component is integrated into each of your keys. The motorcycle's electronics exchange certain continuously changing signals with the electronics in the key; these signals are specific to your motorcycle and they are transmitted via the ring antenna in the ignition lock. The ignition is not enabled for starting until the key has been recognised as authorised for your motorcycle.

 A spare key attached to the same ring as the ignition key used to start the engine could "upset" the electronics, in which case the enabling signal for starting is not issued. The "EWS" warning is displayed in the multifunction display.

Always store the spare key separately from the ignition key. ◀

Replacement and extra keys

You can only obtain replacement/extra keys through an authorised BMW motorcycle dealer. The keys are part of an integrated security system, so the dealer is under an obligation to check the legitimacy of all applications for replacement/extra keys.

If you want to have a lost key barred, you have to bring with you all the keys that belong to the motorcycle. A key that has been barred can subsequently be cleared and reactivated for use.

Hazard warning flashers

Switching on the hazard warning flashers



- Switch on the ignition.
- Press the hazard warning flashers button **1**.
 - » Hazard warning flashers in operation.
 - » Left/right turn indicator tell-tale lights flash.
- Switch off the ignition.
 - » The hazard warning flashers continues to operate.

- » Left/right turn indicator tell-tale lights off.

 The hazard warning flashers can also be switched on by simultaneously pressing the buttons for the left and right turn indicators. ◀

 The hazard warning flashers places a load on the battery. Do not use the hazard warning flashers for longer than absolutely necessary. ◀

Switching off the hazard warning flashers

- Press the hazard warning flashers button **1** or switch on ignition.
- » Hazard warning flashers ceases to operate.

Tripmaster

Selecting the display



 When you switch on the ignition, the information shown by the Tripmaster when the ignition was switched off always reappears on the multi-function display. ◀

- Switch on the ignition.
- Press the Tripmaster button **1** once briefly.



- » The following appear in the display field **2** in this order:
 - Total distance covered
 - Trip odometer 1 (Trip I)
 - Trip odometer 2 (Trip II)
 - Residual range

Residual range

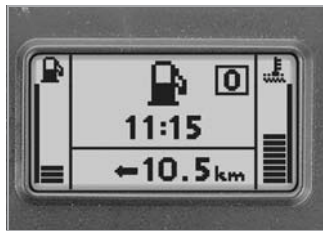

The residual operating range is only displayed when the reserve level is reached. It is determined on the basis of the previous riding style and the available fuel.

If the motorcycle is resting on its side-stand, the level in the tank cannot be measured correctly, so this estimate of residual operating range will be inaccurate.

The Tripmaster registers that you have refuelled when approximately 3 litres have been added.

Resetting the trip meter

- Switch on the ignition.
 - Select the desired trip odometer.
 - Press the Tripmaster button **1** for longer than 2 seconds.
- » The trip meter is set to zero.

Kill switch

The kill switch can be used to switch off the engine easily, either during or after a fall.

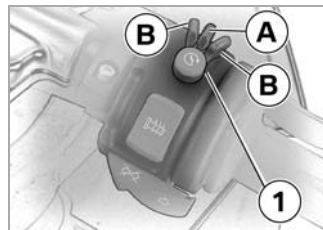

 Operating the kill switch when riding can cause the rear wheel to lock and thus cause a fall.

Do not operate the kill switch when riding. ◀

- Turn kill switch **1** to the left or right to position **B**.
- » The engine electronics control unit switches the engine off.

» The engine cannot be started in this position.

 If the kill switch is moved to position **B** when the ignition is on, the BMW Integral ABS is still functioning (► 50, 69). ◀

Grip heating^{OE}

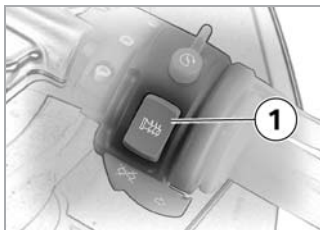

1 Grip heating switch

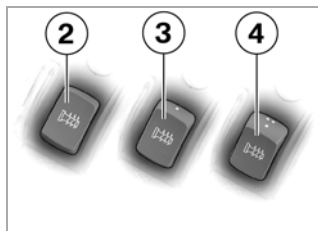

2 Heating function off

3 50% heat output
(one dot visible)

4 100% heat output
(three dots visible)

Grip heating can only be activated when the engine is running.

 The increased power consumption caused by the grip heating can lead to the battery discharging on journeys in the lower engine speed range. If the battery is inade-

quately charged, the grip heating is switched off to ensure starting capability. ◀

Clock

 Adjusting the clock while the motorcycle is being ridden can lead to accidents. Adjust the clock only when the motorcycle is stationary. ◀

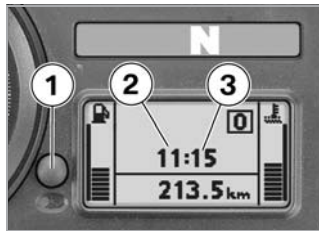

- Switch on the ignition.
- Press button **1** for longer than 2 seconds.

- » Hour display **2** starts to flash.
- Press button **1** briefly.
- » The hours are incremented upwards with every touch.
- Press button **1** for longer than 2 seconds.
- » Minute display **3** starts to flash.
- Press button **1** briefly.
- » The minutes are incremented upwards with every touch.
- Press button **1** for longer than 2 seconds.
- » Adjustment completed.

Handlebar levers

Adjusting the clutch lever

 Adjusting the clutch lever while the motorcycle is being ridden can lead to accidents. Adjust the clutch lever only when the motorcycle is stationary. ◀



- Use adjusting screw **1** to set the gap between the handlebar grip and the clutch lever.
- » Turn clockwise: increased gap.

- » Turn anticlockwise: reduced gap.

 The adjusting screw has a limit position and can be turned more easily if you press the clutch lever forwards. ◀

Adjusting the handbrake lever

 Adjusting the brake lever while the motorcycle is being ridden can lead to accidents. Adjust the brake lever only when the motorcycle is stationary. ◀

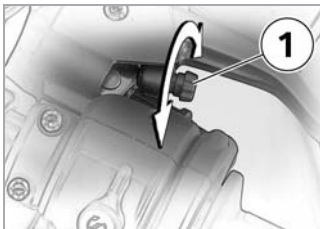

- Use the adjusting screw **1** to set the gap between the handlebar grip and the brake lever.
 - » Turn clockwise: increased gap.
 - » Turn anticlockwise: reduced gap.

 The adjusting screw has a limit position and can be turned more easily if you press the clutch lever forwards. ◀

Lights

Parking light

The parking light switches on automatically when the ignition is switched on.

 The parking light places a load on the battery. Do not switch the ignition on for longer than absolutely necessary. ◀

Low-beam headlight

The low-beam headlight switches on automatically when you start the engine.

 With the engine switched off, you can briefly switch on the light by switching on the high-beam headlight with the ignition switched on or by operating the headlight flasher. ◀

High-beam headlight/ headlight flasher



- Press the high-beam headlight **1** switch at the top.
 - » High-beam headlight switched on.
- Move high-beam headlight **1** switch into the centre position.
 - » High-beam headlight switched off.
- Press high-beam headlight **1** switch at the bottom.
 - » Headlight flasher.

Parking light

You can only switch on the parking light immediately after switching off the ignition.



- Switch off the ignition.
- Press left-hand turn indicator switch **1**.
- » Parking light switched on.
- Switch the ignition on and off again.
- » Parking light switched off.

Headlight setting RHD/LHD vehicles

When riding in countries where traffic drives on the opposite side of the road to that in which the vehicle was registered, the asymmetric low headlight beam will dazzle oncoming traffic.

 Adhesive films with unsuitable adhesives can damage the plastic surface of the headlight.

Only use suitable adhesive films. ◀

- Have the headlight adjusted to the relevant conditions by a specialist workshop, preferably an authorised BMW motorcycle dealer.

Adjusting the vertical aim

The vertical aim is kept constant when the spring preload is adjusted to suit the load.

- Adapting the spring preload and shock absorbers to the load (▶▶ 47).
- Consult a specialist workshop, preferably an authorised BMW motorcycle dealer, if you are unsure whether the headlight basic setting is correct.



In the case of very high payloads, adaptation of the spring preload might not be adequate. To avoid dazzling oncoming traffic:

- Correct the headlight adjustment by adjusting swivelling lever **1**.

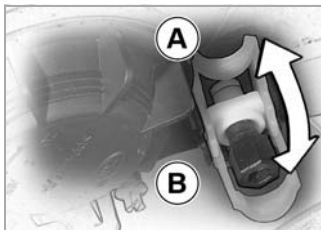

- A** Neutral position
- B** High load

Turn indicators

Switching on the turn indicators



- Press left-hand turn indicator button **1**.
 - » Left-hand turn indicator switched on.
 - » Telltale light for left-hand turn indicator flashes.



- Press right-hand turn indicator button **2**.
 - » Right-hand turn indicator switched on.
 - » Telltale light for right-hand turn indicator flashes.

Switching off the turn indicators



- Press indicator button **3**.
- » Turn indicator off.
- » Turn indicator telltale light is off.

Seat

Removing the seat

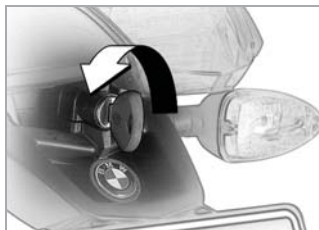

- Turn the key anticlockwise in the seat lock.

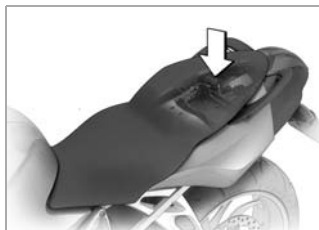

- When doing so, press the seat downwards for support.



- Raise the seat at the rear.
- Let go of the key and pull the seat from the retaining brackets towards the rear.

Setting down the seat

- Place the seat with the covered side downwards on a smooth and clean surface.

 For example, place the seat with the covered side downwards on the fuel tank and the handlebars. ◀

Installing the seat

 If too much pressure is applied in a forward direction, there is a danger that the motorcycle will be pushed off its stand. Make sure that the motorcycle is parked securely. ◀

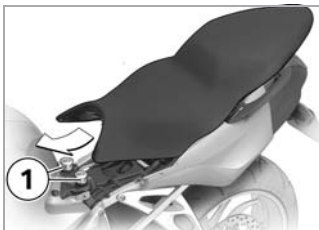

- Push the seat forwards into retaining brackets **1**.

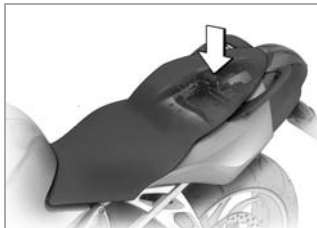

- Press the seat firmly downwards over the detent.
- » The seat can be heard to lock into place.

Helmet holder

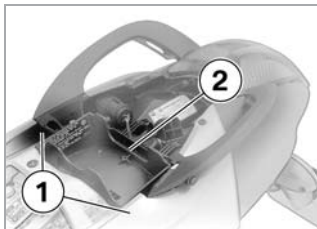

Helmet holders **1** and **2** are located under the seat.

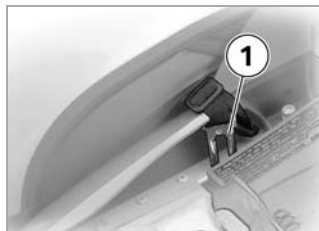

A motorcycle helmet with chin strap can be attached to helmet holders **1**.

- Remove the seat (➔ 40).
- Hook the chin strap into the holder.
- Refit the seat.

 The helmet catch can scratch the panelling. When hooking up the helmet, pay attention to the position of the helmet catch. ◀



If cases are fitted or if the chin strap is too short, a steel cable can be used to secure the motorcycle helmet to helmet holder **2**.

 On the right-hand side of the motorcycle, the helmet could be damaged by heat from the end silencer.

Only attach the helmet to the left-hand side of the motorcycle. ◀

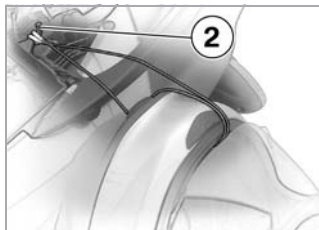

- Remove the seat.
- Pull the steel cable through the helmet and hook it into bracket **2**.
- Refit the seat.

 You can obtain a suitable steel cable from your authorised BMW motorcycle dealer. ◀

Luggage loops



Loops **1** for attaching luggage straps are located on the underside of the seat. In conjunction with eyelets **2** on the grab handles, luggage can be strapped onto the pillion seat.

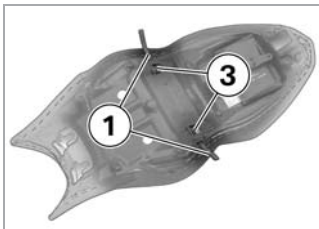

To make the loops accessible:

- Remove the seat and turn it around.
- Pull loops **1** out of retaining brackets **3**.
- Turn the seat around and refit.

Mirrors

Adjusting mirrors

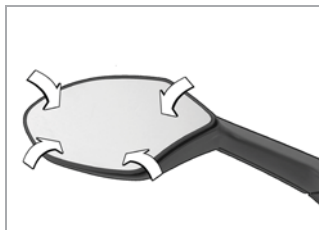

- Move the mirrors into the desired position by pressing lightly on one of the corners.

Spring preload

Adjusting spring preload on the rear wheel



Adjusting the spring preload while the motorcycle is being ridden can lead to accidents.

Adjust the spring preload only when the motorcycle is stationary. ◀

The spring preload must be adapted to the load of the motorcycle. An increase in the load requires an increase in the spring preload; less weight requires a correspondingly lower spring preload.

- Place the motorcycle on the centre stand^{OA} or side stand, ensuring that the ground is firm and level.

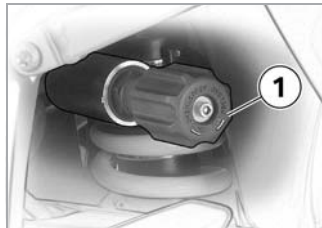

To increase the spring preload:

- Turn handwheel **1** in the direction of arrow HIGH.

To decrease the spring preload:

- Turn handwheel **1** in the direction of arrow LOW.

Basic setting for solo operation:

- Turn handwheel **1** in the arrow direction LOW up to the limit position.
- Turn 15 clicks in the arrow direction HIGH.



One click corresponds to a half turn of the handwheel. The range of adjustment comprises 15 turns. The basic setting is based on a motorcycle with a full fuel tank and one person weighing 85 kg. ◀



Adjustments to the spring preload and shock absorbers that are not co-ordinated lead to a deterioration in the handling characteristics of your motorcycle.

Adapt the damping action of the spring preload. ◀

Shock absorbers

Adjusting the shock absorber on the rear wheel

The damping must be adapted to the spring preload. An increase in the spring preload requires stronger damping, a reduction in the spring preload requires softer damping.

- Place the motorcycle on the centre stand^{OA} or side stand, ensuring that the ground is firm and level.

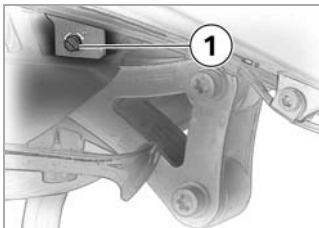

- Adjust the rear wheel shock absorber using a screwdriver to turn adjusting screw **1**.

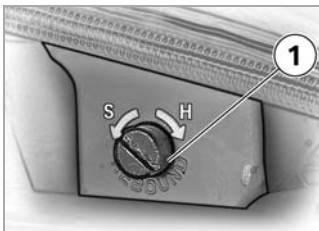

To increase the damping:

- Turn adjusting screw **1** in the direction of arrow **H**.

To decrease the damping:

- Turn adjusting screw **1** in the direction of arrow **S**.

Basic setting for solo operation:

- Turn adjusting screw **1** in the direction of the arrow **H** up to the limit position.
- Turn adjusting screw **1** one and a half turns in the direction of the arrow **S**.



The range of adjustment comprises three and a half turns of adjusting screw. The basic setting is based on a motorcycle with a full fuel tank and one person weighing 85 kg. ◀



Adjustments to the spring preload and shock absorbers that are not co-ordinated lead to a deterioration in the handling characteristics of your motorcycle.

Adapt the damping action of the spring preload. ◀

ESA^{OE}

You can use the Electronic Suspension Adjustment, ESA, to make the following adjustments:

On the front wheel:

– Rebound-stage damping

On the rear wheel:

– Rebound and compression damping

– Spring preload

Calling up settings

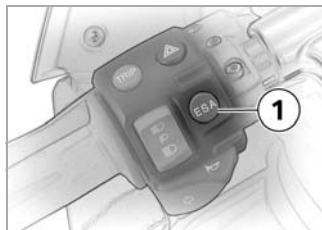

- Switch on the ignition.
- Press button **1** briefly.
- » The current setting is displayed.

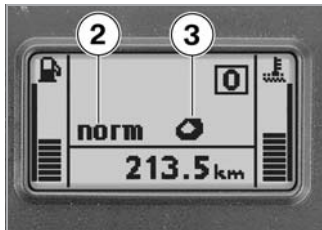

2 Damping set

3 Spring preload set

If button **1** is not pressed for longer than two seconds, the display goes out.

Adjusting the shock absorbers

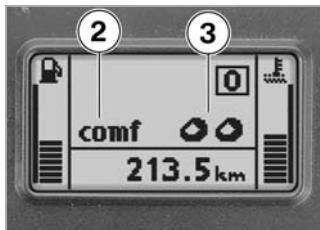

Three adjustments are possible; these are shown in the field **2** as follows:

- comf** Comfort, soft damping
- norm** Normal, medium damping

sport Sport, hard damping

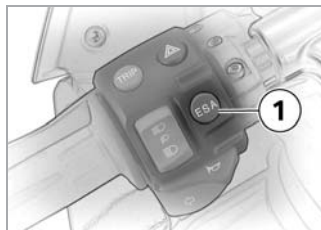

- Switch on the ignition.
- Press button **1** briefly.
- » The current setting is displayed.
- Press button **1** once briefly.
- » Starting from the current status, the display is in the following order:
 - Comfort
 - Normal
 - Sport

If button **1** is not pressed for longer than one second, the shock absorbers are set as displayed.

During the setting procedure, the display flashes.

Adjusting the spring preload

The spring preload cannot be adjusted while the motorcycle is being ridden.

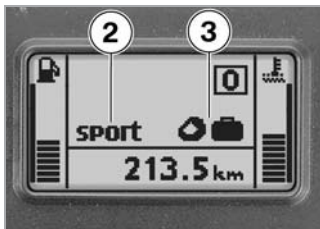

Three adjustments are possible; these are shown in the field **3** as follows:



Solo operation



Solo operation with luggage



Operation with pillion passenger (and luggage)



- Start the engine.
- Press button **1** briefly.
 - » The current setting is displayed.
- Press button **1** once for longer than one second.
 - » Starting from the current status, the display is in the following order:

- Solo operation
- Solo operation with luggage
- Operation with pillion passenger (and luggage)

If button **1** is not pressed for longer than one second, the spring preload will be set as displayed. During the setting procedure, the display flashes.

Wheels

Checking the tyre pressure



Incorrect tyre pressure adversely affects the handling characteristics of the motorcycle and can lead to accidents.

Ensure that the tyres are at the correct pressure. ◀



Incorrect tyre pressure reduces the operating life of the tyres.

Ensure that the tyres are at the correct pressure. ◀

The tyre pressures required can be found in the technical data (➡ 126).



At high road speeds, tyre valves have a tendency to open as a result of centrifugal force.

To avoid sudden loss of tyre pressure, use a metal valve cap with rubber sealing ring on the rear wheel and tighten it securely. ◀

Safety instructions	50
Safety check	52
Making your first trip.....	52
Before you start.....	53
Starting.....	56
Riding	58
Running in.....	58
Shifting gear	59
Placing the motorcycle on its side stand.....	61
Taking the motorcycle off the side stand.....	63
Placing the motorcycle on the centre stand^{OA}	65
Pushing the motorcycle off the centre stand^{OA}	67

Fuel.....	67
Brake system.....	68

Safety instructions

Speed

When riding at high speed, various marginal conditions can adversely affect the handling characteristics of the motorcycle:

- adjustment of the spring-strut and shock absorber system
- unequally distributed load
- loose clothing
- insufficient tyre pressure
- poor tyre tread
- etc.

Correct loading

 Overloading can adversely affect the riding stability of the motorcycle.

Do not exceed the permissible gross weight and permissible wheel loads (►► 137). ◀

Alcohol and drugs

 Even small amounts of alcohol or drugs can considerably adversely affect your perception, judgement and ability to make decisions, as well as your reflexes. Taking medication can increase these effects.

Do not ride your motorcycle after consuming alcohol, drugs and/or medication. ◀

Risk of poisoning

Exhaust fumes contain carbon monoxide, which is colourless and odourless but highly toxic.

 Inhaling exhaust fumes is a health hazard and can lead to loss of consciousness or death.

Do not inhale exhaust fumes. Do not run the engine in enclosed spaces. ◀

High voltage

 Touching live parts of the ignition system with the engine running can lead to electric shocks.

Do not touch any parts of the ignition system when the engine is running. ◀

Catalytic converter

If misfiring causes unburned fuel to enter the catalytic converter, there is a danger of overheating and damage.

For this reason, observe the following points:

- Do not ride the motorcycle with the fuel tank empty.
- Do not run the engine with the spark-plug cap removed.
- In the event of engine misfiring, stop the engine immediately.
- Only refuel using unleaded fuel.
- Be sure to adhere to the prescribed maintenance intervals.

 Unburned fuel destroys the catalytic converter.

Note the points listed for protection of the catalytic converter. ◀

Risk of fire

High temperatures occur at the exhaust pipe.

 If highly flammable materials (e.g. hay, leaves, grass, clothing and luggage, etc.) make contact with the hot exhaust pipe, they can start to burn.

Ensure that no highly flammable materials can come into contact with the hot exhaust system. ◀

 –If the engine runs for a longer period when the motorcycle is stationary, the cooling is inadequate and overheating can occur. In extreme cases, the motorcycle could catch fire.

Do not let the engine run for unnecessary periods when

the motorcycle is stationary. After starting, move off immediately. ◀

Manipulation of the engine electronics control unit

 Manipulation of the engine electronics control unit can cause damage to the motorcycle and therefore lead to accidents. Do not manipulate the engine electronics control unit. ◀

 Any manipulation of the engine electronics control unit can lead to mechanical loads for which the components of the motorcycle are not configured. Damage caused in this way invalidates the warranty. Do not manipulate the engine electronics control unit. ◀

Safety check

Prior to every journey

Use the following checklist to check important functions, settings and wear limits before starting to ride.

Checklist

- Brakes (➡ 93)
- Brake fluid level (➡ 91)
- Clutch function (➡ 93)
- Clutch fluid level (➡ 93)
- Warning and telltale lights (➡ 18)
- Shock absorber setting (➡ 44, 46) and spring preload (➡ 47)
- Rims (➡ 94), tread depth (➡ 94) and tyre pressure (➡ 47)
- Load, gross weight (➡ 137)
- Secure luggage system

At regular intervals:

- Engine oil level (every time you refuel) (➡ 86)
- Brake pads (every second/third time you refuel) (➡ 90, 91)

Making your first trip

Safe handling of your motorcycle

Each motorcycle has its 'own life' that you have to get used to:

- Acceleration capability
- Road holding
- Cornering characteristics
- Braking power

The engine also has to be run in during the first 1,000 km (➡ 58).

You will find information on BMW Integral ABS from (➡ 69) onwards.



BMW Integral ABS incorporates braking power assistance, so that braking power is significantly higher than with conventional brake systems. Especially when cornering, unintentionally hard braking can lead to dangerous situations. Practice braking with BMW Integral ABS in safe situations. ◀

Before you start

Switching on the ignition

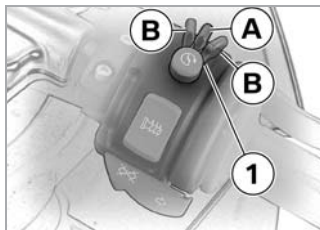



- Read the information on the EWS (► 22).
- Kill switch **1** in operating position **A**.
- Switch on the ignition.
 - » Pre-ride check is carried out.
 - » With BMW Integral ABS: ABS self-diagnosis is performed.

Pre-ride check

After the ignition has been switched on, a pre-ride check is carried out. Here, the functions of all warning lights and warning symbols are checked. The following are displayed in succession in the multifunction display:

Phase 1







-  General warning light lights up red.
-  Engine oil pressure symbol is displayed.

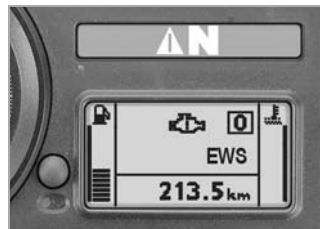

Battery charge current symbol is displayed.

Phase 2



-  General warning light lights up yellow.
-  Engine electronics symbol is displayed.
-  EWS symbol is displayed.

Phase 3



Lamps defective warning light is displayed.



If one of the warning lights or a warning symbol cannot be displayed, a function fault in the corresponding system cannot be displayed.

Pay attention to the displays for all lights and symbols. ◀

If one of the lights or symbols is not displayed:

- Have the fault remedied as soon as possible by a specialist workshop, preferably an authorised BMW motorcycle dealer.

After completion of the pre-ride check, the current values are displayed.



If the engine is started during the pre-ride check, the pre-ride check is cancelled. ◀

With BMW Integral ABS, the ABS self-diagnosis is also carried out.

ABS self-diagnosis

The ABS warning light is shown in one of the following three variants depending on the country:

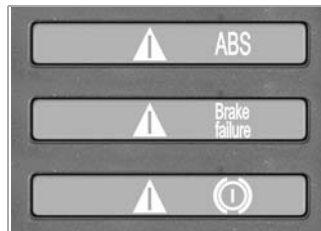

The operational readiness of the BMW Integral ABS is checked by the self-diagnosis and starting-off test (► 58). Self-diagnosis is performed automatically when you switch on the ignition.

Self-diagnosis is not performed unless both brake levers are in their fully released

positions. Before conclusion of the self-diagnosis, only residual braking function (► 71) is available.

- Release the brake lever.
- Switch on the ignition.

Phase 1

 General warning light lights up.

 ABS warning light flashes 4 times per second.

Self-diagnosis is carried out.

Phase 2

 ABS warning light flashes once per second.

Self-diagnosis is complete.

The warning light goes out after completion of the start-off test (► 58).



If the ignition is switched on with the brake lever operated and then the engine is started and the motorcycle moves off immediately, the BMW Integral ABS is still in the residual braking function (► 71). The self-diagnosis is carried out as soon as the brake lever is released completely for the first time. During this period, neither the ABS function nor the braking power assistance is available.

When you start the engine, wait until the ABS self-diagnosis has been carried out. ◀



Starting on gradients: Switch on the ignition with the gear engaged, clutch lever released and brake lever released. Then press the brake, press the clutch and start the engine. ◀

Side-stand

If the side stand is extended and a gear is engaged, you cannot start the motorcycle. If the motorcycle has been started in neutral and a gear is then engaged while the side stand is extended, the engine switches off.

Manual gearbox

The motorcycle can be started in the neutral position or with a gear engaged and the clutch pressed. Only press the clutch after switching on the ignition. In the neutral position, the "neutral" telltale light lights up in green and the gear display in the multifunction display shows 0.

Starting

 Do not turn the throttle twistgrip when starting the engine. At ambient temperatures below 0 °C, disengage the clutch after switching on the ignition. ◀



- Press starter button **1**.
- » The engine starts.
- Observe warning and information displays (► 18-28).

 The start attempt is automatically interrupted if the battery voltage is too low. Prior to renewed starting attempts, charge the battery or obtain starting assistance (► 111). ◀

 High engine speeds with a cold engine could lead to increased engine wear. Avoid high engine speeds when the engine is cold. ◀

 If you are unable to start the engine, the following troubleshooting chart can provide assistance. ◀

Troubleshooting chart

Fault: Engine does not start or only starts with difficulty.

Possible cause	Remedy	see page
Kill switch activated	Kill switch in operating position	(➡ 53)
Side stand extended and gear engaged	Retract the side stand fully	(➡ 63)
Gear engaged, clutch not disengaged	Place the gearbox in neutral or press the clutch	(➡ 56)
Clutch operated with ignition switched off	Switch on the ignition first, then operate the clutch	(➡ 53, 56)
No fuel in tank	Refuel	(➡ 67)
Battery not adequately charged	Recharge the battery	(➡ 113)

Riding

ABS starting-off test

The ABS warning light is shown in one of the following three variants depending on the country:

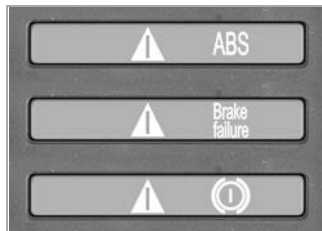

ABS ABS warning light flashes once per second.

After starting off, the BMW Integral ABS checks the ABS sensors. The ABS warning light then goes out and the BMW Integral ABS is active.

Running in

- During the running-in period, ride in frequently changing load and engine speed ranges.
- Choose hilly routes with a large number of corners, but avoid motorways where possible.

 Exceeding the running-in speeds increases engine wear.

Adhere to the guide values described below. ◀

Up to 1,000 km distance ridden

- Engine speed max. 7,000 rpm.
- No full-load acceleration.
- At full load, avoid low engine speeds.

- After 500 – 1,200 km be sure to have the first inspection carried out.

Brake pads

New brake pads must "bed down" and therefore do not achieve their optimum friction levels during the first 500 km. The reduction in braking efficiency can be compensated for by exerting greater pressure on the brake lever.

 New brake pads can considerably lengthen the braking distance. Brake carefully and safely. Avoid braking sharply. ◀

Tyres

New tyres have a smooth surface. This means that they have to be roughened by being run in with a moderate riding style, leaning over in alternating positions. It is only after tyres have been run in that the contact faces achieve their full gripping capability.

 New tyres do not yet have full grip; risk of accident when leaning over too far. Avoid leaning over too far. ◀

Shifting gear

Engine speed

Do not use the high end of the engine speed range in any gear unless the engine is at operating temperature. When the rev. counter is in the red zone on the dial, the throttle-valve angle is restricted in order to protect the engine. The governor cuts in at 10,800 rpm.

Gear shifts



Shifting gear with the clutch engaged can destroy the gearbox. Only shift gear with the clutch disengaged. ◀



The gear indicator in the multifunction display shows the gear selected. ◀



Placing the motorcycle on its side stand



The motorcycle cannot stand securely on uneven ground.

Ensure that the stand is set down on an even and firm surface. ◀

When sitting on the motorcycle:

- Switch off the engine.
- Apply the handbrake.
- Place the motorcycle vertically and balance it out.
- Use your left foot to fold the side stand towards the side up to its limit position (arrow).
- Slowly lean the motorcycle on the stand, relieving the load, and dismount to the left.

- Turn the handlebars to the full left or right lock position.
- Check that the motorcycle is standing firmly.



If the motorcycle is on the side stand, the surface of the ground determines whether it is better to turn the handlebars to the left or right.

However, the motorcycle is more stable on a level surface with the handlebars turned to the left than with the handlebars turned to the right.

On level ground, always turn the handlebars to the left to set the steering lock. ◀



The side stand is only configured for the weight of the motorcycle.

Do not sit on the motorcycle with the side stand extended. ◀



On uphill gradients, position the motorcycle in the "uphill" direction and engage 1st gear. ◀



Taking the motorcycle off the side stand



With the ignition switched off, there is no braking power assistance; the motorcycle can begin to roll.

Especially on inclines, switch on the ignition and wait for the ABS self-diagnosis (▣ 54). ◀

- Unlock the ignition lock, switch on the ignition.
- Wait for the ABS self-diagnosis.
- From the left, grip the handlebars with both hands.
- Apply the handbrake.
- Swing your right leg over the seat, straightening the motorcycle as you do so.
- Place the motorcycle vertically and balance it out.

- Sit down and fold back the side stand with your left foot.



An extended side stand can catch on the ground when the motorcycle is moving and lead to a fall.

Fold in the side stand before moving the motorcycle. ◀



Placing the motorcycle on the centre stand^{OA}



The motorcycle cannot stand securely on poor ground.

Ensure that the stand is set down on a firm and even surface. ◀

- Switch off the engine.
- Dismount, keeping your left hand on the handlebar grip.
- With your right hand, take hold of the pillion passenger grab handle or rear frame.
- Place your right foot on the actuating pin of the centre stand and press the centre stand downwards until the rolling feet make contact with the ground.

- Place your full body weight on the centre stand and at the same time pull the motorcycle backwards (arrow).
- Check that the motorcycle is standing firmly.



The centre stand can fold in if there is excessive motion and lead to the vehicle falling over.

Do not sit on the motorcycle with the centre stand extended. ◀

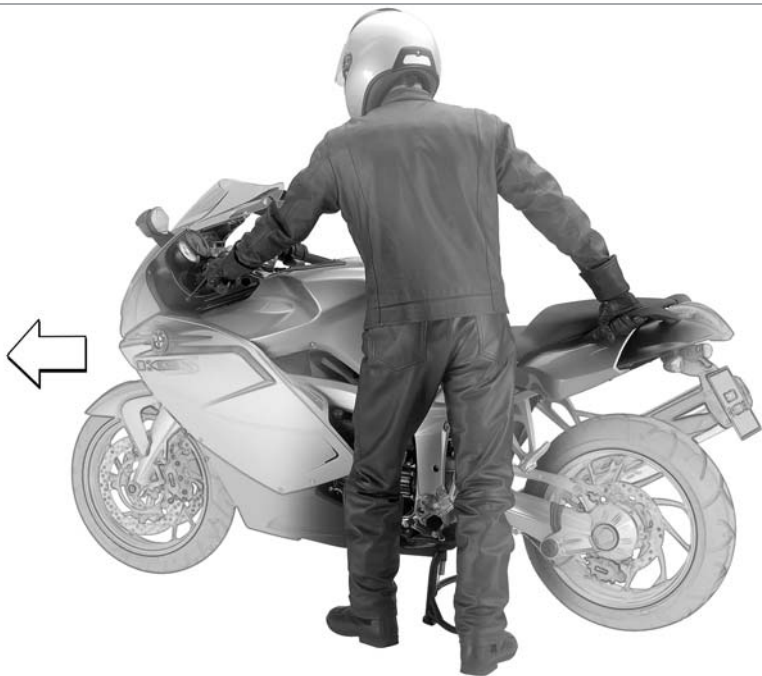

Pushing the motorcycle off the centre stand^{OA}

 With the ignition switched off, there is no braking power assistance; the motorcycle can begin to roll. Especially on inclines, switch on the ignition and wait for the ABS self-diagnosis (►► 54). ◀

- Unlock the ignition lock, switch on the ignition.
- Wait for the ABS self-diagnosis.
- Place your left hand on the left handlebar grip.
- With your right hand, take hold of the pillion passenger grab handle.
- Push the motorcycle forwards off the centre stand.

- Check whether the centre stand has folded in fully.

Fuel

Refuelling

 Fuel is a fire hazard and explosive!

Do not smoke and make sure that there are no naked flames during all activities at the fuel tank. ◀

 Fuel expands under the influence of high temperatures and exposure to sunlight.

Fill up only to the lower edge of the filler neck. ◀

 Fuel can damage plastic parts.

Avoid fuel coming into contact with body panels. ◀

- Place the motorcycle on the centre stand^{OA} or side stand, ensuring that the ground is firm and level.

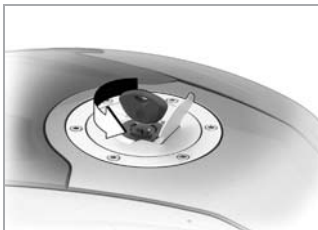

- Open the protective cap.
- Open the fuel tank cap with the ignition key by turning it anticlockwise.



- Fill up the tank with fuel of the approved quality.
- Close the fuel tank cap with firm pressure.
- Remove the key and close the protective cap.

Fuel quality

 Ledged fuel destroys the catalytic converter.

Use only unleaded fuel. ◀

The engine is designed to run on:

- Premium grade unleaded fuel (98 ROZ/RON, 88 MOZ/MON)

Fill up preferably with this fuel to comply with the nominal values for performance and fuel consumption.

In addition, the following fuel quality can be used:

- Premium grade unleaded fuel (95 ROZ/RON, 85 MOZ/MON)

Capacity

- Usable fuel capacity: 19 litres
- Of which reserve fuel: approx. 4 litres

 The volume of fuel display in the multifunction display only works when the ignition is switched on. ◀

Brake system

General

Descending mountain passes

 If the rear brake is used exclusively for braking when descending steep inclines, there is a risk of losing braking efficiency. Under extreme conditions, the brakes could overheat and suffer severe damage.

Use the front and rear brakes and the engine brake. ◀

Wet brakes

 After washing the motorcycle, after riding through water or when it is raining, the braking effect can be delayed due to damp brake discs and brake pads.

Note that there will be an extended braking distance until the brakes have dried out or the act of braking itself dries them. ◀

Salt on brakes

 The brakes may fail to take effect immediately if the motorcycle was ridden on salt-covered roads and the brakes were not applied for some time.

Note that there will be an extended braking distance

until the salt layer on the brake discs and brake pads is removed by braking. ◀

Oil or grease on the brake

 Oil and grease deposits on brake discs and pads considerably reduce the braking effect.

Especially after repair and maintenance work, make sure that the brake discs and brake pads are free of oil and grease. ◀

Dirt or mud on brakes

 When riding on loose surfaces or muddy roads, the brakes may fail to take effect immediately because of dirt or moisture on the discs or brake pads.

Note that there will be an

extended braking distance until the brakes have been cleaned by braking. ◀

BMW Integral ABS

Sensitive electronic control

It takes skill and sensitive control of the brakes to pull up safely on a motorcycle. If the front wheel brake locks and the wheel skids, the necessary longitudinal and lateral stabilising forces are lost, and a fall can result. For this reason, the rider seldom makes full use of available braking performance in an emergency.

BMW Integral ABS provides improved braking deceleration by means of anti-lock braking for both wheels and braking force distribution by means of the integral braking function (▶ 50, 69). Making full use of

the motorcycle's technical braking capacity will minimise braking distances noticeably, even when road conditions are poor. When riding straight ahead, the BMW Integral ABS enables secure, optimised emergency braking which corresponds to the circumstances.

Reserves for safety

The potentially shorter braking distances which BMW Integral ABS permits must not be used as an excuse for careless riding. ABS is primarily a means of ensuring a safety margin in genuine emergencies.

Take care when cornering.

When you apply the brakes on a corner, the motorcycle's weight and momentum take

over and even BMW Integral ABS is unable to counteract their effects.

Integral braking

The integral braking function activates the front and rear brakes jointly, which means that both wheels are braked when one brake lever is pressed. The electronics in the BMW Integral ABS controls the braking force distribution between the front and rear brakes. Braking-force distribution depends on load and is recalculated every time the ABS controller comes into action.

Partial integral braking

Your motorcycle is fitted with partial integral braking. In this partially integral brake configuration, the integral braking function is activated only when you pull the handbrake lever. The footbrake lever acts only on the rear brake.

Braking power assistance

On braking, BMW Integral ABS boosts the brake force on the wheel by means of a hydraulic pump. By boosting the braking force in this way, BMW Integral ABS achieves higher braking efficiency than standard brake systems.

ABS anti-lock braking system

ABS prevents the wheels from locking on braking, making a major contribution to road safety.

Lifting up the rear wheel

With strong adhesion between the tyres and the road, the front wheel locks either very late or not at all when the brakes are applied hard. Accordingly, the ABS control only has to intervene very late or not at all. In this case, the rear wheel can lift up, which can lead to the motorcycle rolling over.



Heavy braking can cause the rear wheel to rise. Bear in mind that the ABS control is unable to prevent the rear wheel from lifting up in every instance. ◀

Residual braking function

With the ignition switched off, during the self-diagnosis and in the event of a fault in the BMW Integral ABS, the brake circuits concerned only have the residual braking function. The residual braking function is the braking power without the hydraulic servo assistance of the BMW Integral ABS. Under these circumstances, therefore, you must apply considerably higher pressure to the brake levers in question in order to apply the brakes, and lever travel is longer. When the

residual braking function is active, the ABS function is unavailable in the brake system in question. When the residual braking function is active, the integral braking function is partially or entirely unavailable.



Without the ABS function, the wheels may lock under braking; without braking power assistance, considerably greater force is required to brake. Brake carefully and safely. Avoid braking sharply. Have the fault remedied as soon as possible by a specialist workshop, preferably an authorised BMW motorcycle dealer. ◀

 As the residual braking function means that the lever travel before the brake pressure is built up can be longer, we recommend that you set a larger lever travel at the handbrake lever (➡ 36). ◀

 In the case of residual braking function in both brake circuits, no pump noise can be heard when the brake lever is operated. ◀

General instructions	74
Power socket.....	74
Luggage system	77
Breakdown assistance kit for tubeless tyres	82

General instructions

BMW recommends the use of parts and accessories for your motorcycle that are approved by BMW for this purpose. Your authorised BMW motorcycle dealer is the correct contact for original BMW parts and accessories, as well as other products approved by BMW and appropriate, qualified advice.

These parts and products have been tested by BMW for safety, function and suitability. BMW accepts product liability for these products. BMW cannot accept liability for any non-approved parts or accessories.



BMW cannot assess each non-BMW product to determine whether it can be used on BMW motorcycles without any safety risk. This guarantee is also not given in the event that a country-specific official authorisation has been provided. Tests conducted by these bodies cannot always make provision for all operating conditions experienced by BMW motorcycles and, consequently, they are not sufficient in some circumstances.

Use only parts and accessories approved by BMW for your motorcycle. ◀

Whenever you are planning such modifications, comply with all the legal requirements. The motorcycle must not infringe national road-vehicle construction and use regulations.

Power socket



Connection

Power socket **1** provides a voltage of 12 V and can carry a maximum load of 5 A.

If the battery voltage is too low and/or the maximum permissible load is exceeded, the power socket is automatically deactivated.

Operating auxiliary devices

Auxiliary devices can only be started up with the ignition switched on. The auxiliary device remains operational if the ignition is subsequently switched off. Approx. 15 minutes after switching off the ignition and/or during the restart operation, the on-board socket is switched off to take the load off the vehicle electrical system.

Wiring

The cables from the power socket to the auxiliary device must be routed in such a way that they:

- do not impede the rider
- do not restrict or obstruct the steering angle and handling characteristics
- cannot be trapped



Improperly routed cables can impede the rider. Route the cables as described above. ◀

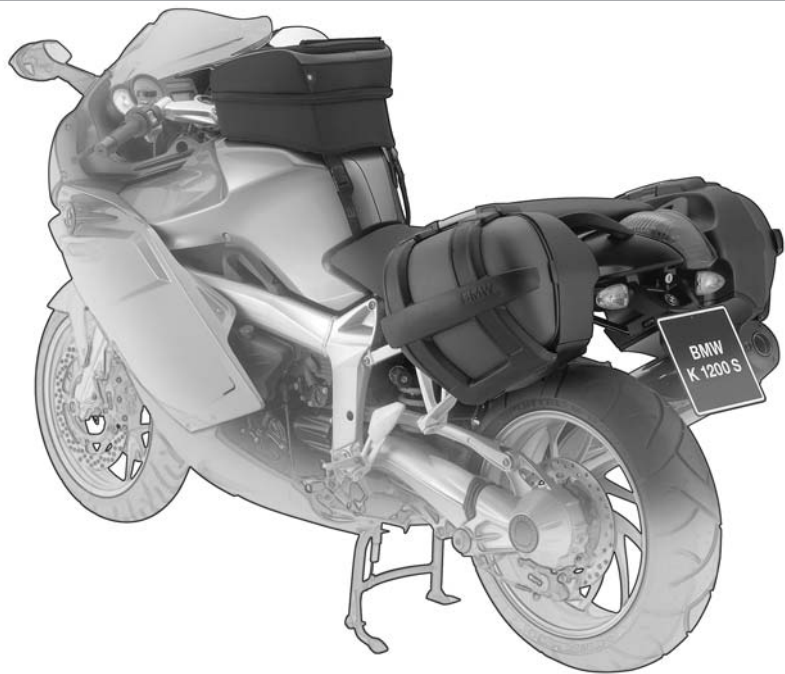

Luggage system

Correct loading

 Overloading and uneven loading can adversely affect the riding stability of your motorcycle.

Do not exceed the permissible gross weight and permissible wheel loads (➡ 137). Observe the following information on loading. ◀

- Adapt the settings for spring preload (➡ 47), damping (➡ 44, 46) and tyre pressure (➡ 126) to the gross weight.
- Ensure that the case volumes on the left and right are equal.
- Ensure that the weight is equally distributed on the left and right.

- Pack heavy items of luggage downwards and inwards.
- Load the left-hand and right-hand cases^{OA} with a maximum of 8 kg each.
- Load the tank rucksack with a maximum of 5 kg.

Release levers

There is a release lever on the left and right of each case lock.

The grey lever with the inscription OPEN is used to open and close the cases.

The black lever with the inscription RELEASE is used to remove and attach the cases.

Key positions

Cases locked and secured

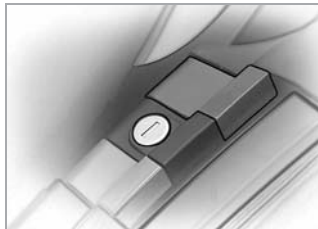

- Lock in direction of travel.
 - » Case locked.
 - » Case secured.
 - » Key can be removed.

Cases not locked and secured

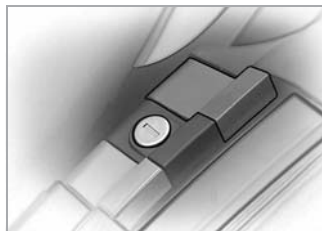

- Turn the lock on the right-hand case by 90° anticlockwise.
- Turn the lock on the left-hand case by 90° clockwise.
 - » Case can be opened.
 - » Case secured.
 - » Key can be removed.

Case unsecured

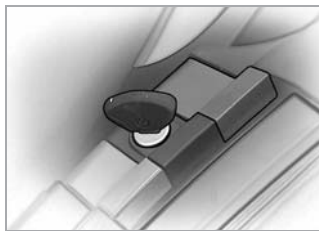

- Turn the lock on the right-hand case by 45° clockwise.
- Turn the lock on the left-hand case by 45° anticlockwise.
 - » Cases locked.
 - » Cases can be removed.
 - » Key cannot be removed.

Opening the cases

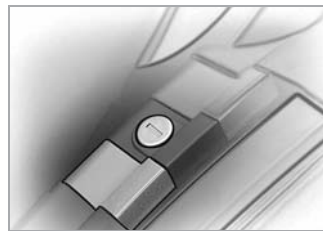

- Turn the case lock to the position "case unlocked".
- Pull the grey release lever upwards.



- » Lock straps **1** open.
- Pull the grey release lever upwards once again.
- Pull case lid **2** out of the retainer.
- » Case fully opened.



Closing the cases

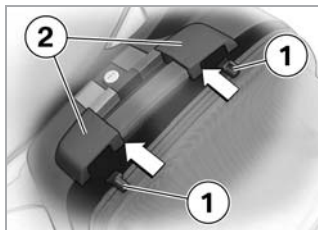

- Press catches **1** on the case lid into retainers **2**.
- » The catches can be heard to lock into place.

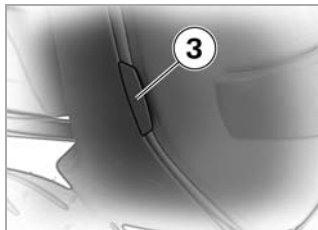

 When closing, ensure that the case lid remains within limit **3**. ◀

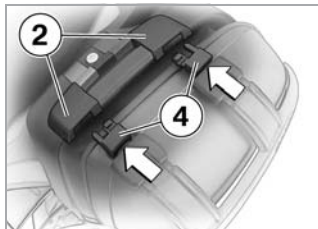

- Press catches **4** on the lock straps into retainers **2**.
- » The catches can be heard to lock into place.
- Check that the catches are locked securely into place.

Adjusting the case volume

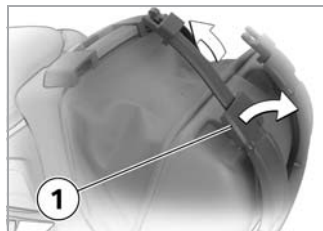

- Close the case lid.
- Turn the lock strap buckles **1** of the lock straps outwards.
- Pull out the lock straps upwards.
- » The maximum volume has been set.



- Close the lock straps.
- Press the lock straps against the case body.
- » The case volume is adapted to the contents.

Fitting the cases

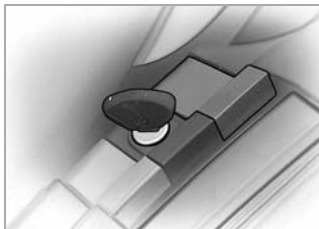

- Turn the case lock to the position "case unsecured".

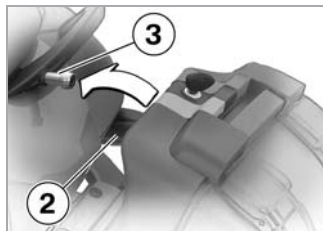

- Hook the case into the lower mounting **2**.
- Pull the black release lever upwards.
- Press the case into the upper mounting **3**.
- Press the black release lever downwards.
- » The case is locked into place.
- Lock the case.
- Check for secure locking.

Removing the cases

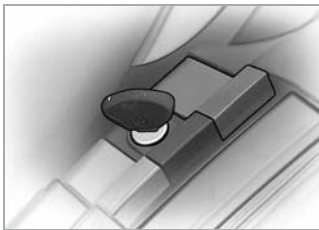

- Turn the case lock to the position "case unsecured".
- Pull the black release lever upwards.

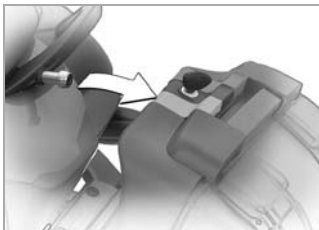

- Pull the case out of the upper mounting.
- Lift the case out of the lower mounting.

Adapting the cases



If a case wobbles or is difficult to fit, it has to be adapted to the gap between the upper and lower mounting.

To achieve this, the height of the lower bracket on the case can be changed.



- Open the case.
- Undo screws **1**.
- Set the height of the bracket.
- Tighten the screws.

Breakdown assistance kit for tubeless tyres

The breakdown assistance kit is located under the left side panel. The repair sequence and safety information can be taken from the accompanying description.

- Remove the seat.
- Remove the screws **1**.

 You will find an overview of the types of screw used on (➔ 124).

- Remove the side panel.

 To protect the side panel from scratches, place it on the seat. ◀

- Open the retaining strap and remove the breakdown assistance kit.

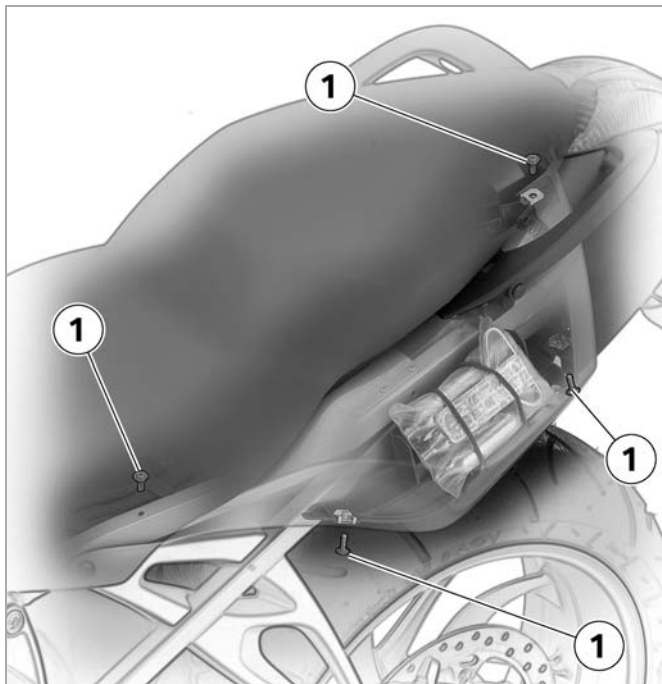

Toolkit.....	85
Engine oil	86
Coolant.....	88
Brakes	89
Clutch	93
Wheels.....	94
Front-wheel stand.....	103
Rear wheel stand	104
Bulbs.....	105
Jump starting.....	111
Battery.....	112
Splash guard.....	116

The "Maintenance" chapter describes work involving the replacement of wear parts that can be performed with minimum effort.

The types of screws used for the components concerned are listed on (▶▶▶ 124-125). You can use this chart to set aside the required tools.

If special tightening torques are to be taken into account for assembly, these are also listed. Screw connections for which there is a suitable tool in the toolkit are marked additionally.

If you are interested in information on more extensive work, we recommend the repair manual on CD-ROM which applies to your particular motorcycle. You can obtain a copy of this from your authorised BMW motorcycle dealer.

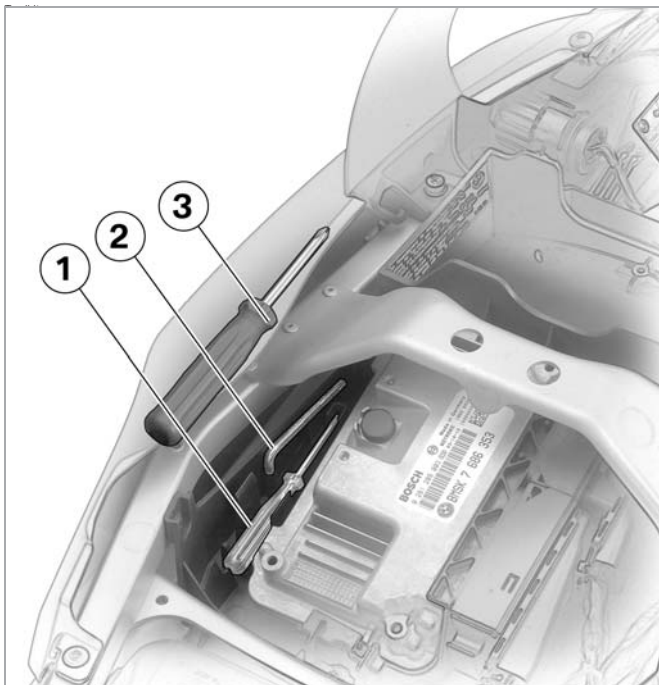

Toolkit

The toolkit is located under the seat.

- Remove the seat (➔ 40).

1 Removable screwdriver

- Take out the screwdriver **1**.

» The following are accessible:

2 Torx spanner T25

3 Screwdriver, small

Engine oil

Checking the engine oil level

Check the oil level at regular intervals.

 The oil level depends on the oil temperature. The higher the temperature the higher the oil level in the oil tank.

Check the engine oil level immediately after a longer journey. ◀

 After longer motorcycle immobilisation periods, oil can collect in the oil pan; this must be pumped into the oil tank before the reading is taken. The engine oil must be at operating temperature to do this. Checking the oil level with the engine cold or after a short

trip leads to misinterpretations and therefore to incorrect oil fill quantities.

To ensure that the correct engine oil level is displayed, only check the oil level after a longer trip. ◀

- With the motorcycle at operating temperature, hold it vertically or place it on the centre stand^{OA}, ensuring that the ground is firm and level.
- Let the engine run in neutral for one minute.
- Switch off the ignition.
- Read off the oil level.

 If you have a motorcycle without a centre stand^{OA}, obtain assistance from another person when reading the oil level. ◀

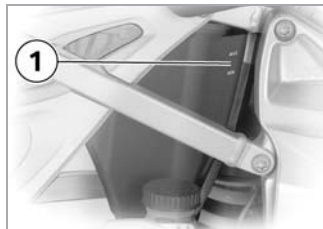

1 Display for engine oil level

- Read off the oil level from engine oil level display **1**.

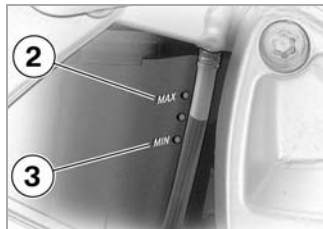

2 Maximum engine oil level

3 Minimum engine oil level

The oil level must be located between the **MIN** and **MAX** marks. The difference is approx. 0.5 litres.

If the oil level is below the **MIN** mark:

- Top up the engine oil.

If the oil level is above the **MAX** mark:

- Drain off the engine oil.

 Too little or too much engine oil can lead to engine damage.

Ensure that the engine oil level is correct. ◀

 Too little engine oil can result in the engine seizing and therefore lead to accidents.

Ensure that the engine oil level is correct. ◀

Topping up the engine oil

- Remove the seat (➔ 40).

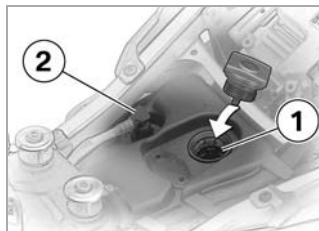

- Clean the area around the filler aperture.
- Unscrew cap of the engine oil filler aperture **1**.



- Add engine oil up to the central mark **A**.
- Check the oil level.
- Repeat the filling and checking procedure until the engine oil level is located between the **MIN** and **MAX** marks.
- Screw on the cap of the engine oil filler aperture.

Draining off engine oil

- Remove the seat (➔ 40).
- Press the retainer of clear hose **2** on the left and right and pull upwards out of the oil tank.
- Pull the clear hose downwards out of the frame and drain off the oil into a suitable container.
- Insert the clear hose in the oil tank and lock into place.
- Check the oil level.
- Repeat the draining and checking procedure until the engine oil level is located between the **MIN** and **MAX** marks.
- Store or dispose of excess engine oil in an environmentally-responsible manner.

Coolant

Checking the coolant level

Check the coolant level at regular intervals.

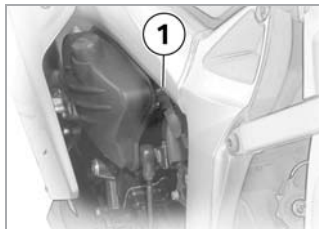

1 Display for coolant level

- Read off the coolant level from the coolant display **1**.

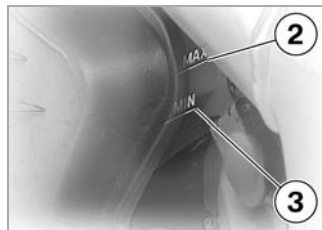

2 Maximum coolant level

3 Minimum coolant level

The coolant level must be located between the **MIN** and **MAX** marks.

If the coolant is below the **MIN** mark:

- Top up the coolant.

Topping up the coolant

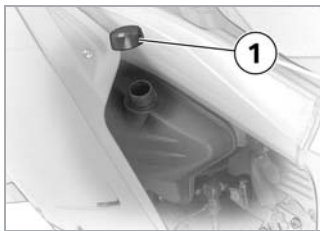

- Unscrew cap of the coolant filler aperture **1**.
- Add coolant.
- Check the coolant level.
- Repeat the filling and checking procedure until the coolant level is located between the **MIN** and **MAX** marks.
- Screw on the cap of the filler aperture for coolant.

Brakes

A properly functioning brake system is a basic requirement for the road safety of your motorcycle.



Improperly performed work jeopardises the operating reliability of the brake system.

Have all work on the brake system performed by a specialist workshop, preferably by an authorised BMW motorcycle dealer. ◀

Checking the function

Do not ride the motorcycle if you have any doubts about the safety of the brake system. In this case:

- Have the brake system checked by a specialist workshop, preferably an authorised BMW motorcycle dealer.

Vehicles without ABS

- Press the handbrake lever.
 - » A resistance point must be noticeable.
- Press the footbrake lever.
 - » A resistance point must be noticeable.

Vehicles with ABS

- Switch on the ignition.
- Wait for the ABS self-diagnosis.
- Press the handbrake lever.
 - » A resistance point must be noticeable.
 - » In the case of BMW Integral ABS, the hydraulic pump must be heard to run.
- Press the footbrake lever.

- » A resistance point must be noticeable.
- » In the case of BMW Integral ABS, the hydraulic pump must be heard to run.

Brake pads

 Falling short of the minimum pad thickness leads to reduced braking power and under certain circumstances to brake damage.

In order to ensure the operating reliability of the brake system, make sure that the minimum thickness is exceeded. ◀

Checking the brake pad thickness at the front

- Place the motorcycle on the centre stand^{OA} or side stand, ensuring that the ground is firm and level.



- Perform a visual inspection of the brake pad thickness on the left and right.

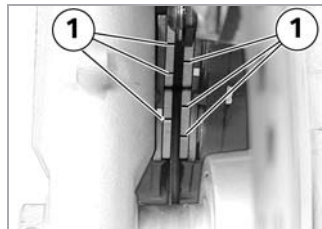

The brake pads must have a clearly visible wear indicating mark **1**. If the wear indicating mark is no longer clearly visible:

- Have the brake pads replaced by a specialist workshop, preferably by an authorised BMW motorcycle dealer.

Checking the brake pad thickness at the rear

- Place the motorcycle on the centre stand^{OA} or side stand, ensuring that the ground is firm and level.

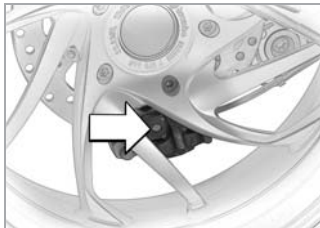

- Perform a visual inspection of the brake pad thickness from the right.



The brake disc must not be visible through bore hole **1** of the inner brake block. If the brake disc is visible:

- Have the brake pads replaced, preferably by an authorised BMW motorcycle dealer.

Checking the brake fluid level



If the position of the brake-fluid reservoir is changed, air can enter the brake system.

Do not twist either the handle-bar controls or the handle-bars. ◀

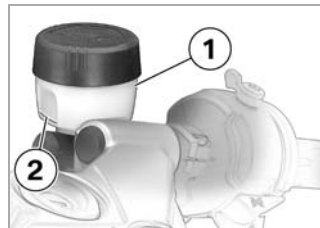

- 1** Front brake-fluid reservoir
- 2** **MIN** mark

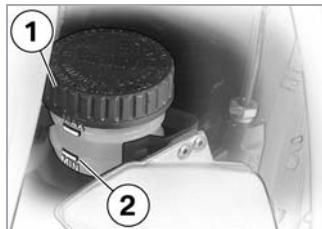

1 Rear brake-fluid reservoir

2 **MIN** mark

- Hold the motorcycle vertically or place it on the centre stand^{OA}, ensuring that the ground is firm and level.
- Straight ahead handlebar position.
- Read off the brake fluid level at the reservoir.

Vehicles without ABS

 In the event of brake pad wear, the brake fluid level in the brake-fluid reservoir falls. ◀

The brake fluid level must not fall below the **MIN** mark. If the brake fluid level falls below the **MIN** mark:

 If there is too little brake fluid in the brake-fluid reservoir, air can enter the brake system. This causes a serious reduction in braking efficiency.

Brake carefully and safely. Avoid braking sharply. ◀

- Have the fault remedied as soon as possible by a specialist workshop, preferably an authorised BMW motorcycle dealer.

Vehicles with ABS

 In the event of brake pad wear, the brake fluid level remains constant. ◀

If the brake fluid level falls - even above the **MIN** mark - this indicates a defect in the brake system. If the brake fluid level falls:

 If there is too little brake fluid in the brake-fluid reservoir, air can enter the brake system. This causes a serious reduction in braking efficiency.

Brake carefully and safely. Avoid braking sharply. ◀

- Have the fault remedied as soon as possible by a specialist workshop, preferably an authorised BMW motorcycle dealer.

Clutch

Checking the function

- Press the clutch lever.
- » A resistance point must be noticeable.

Do not ride the motorcycle if you have any doubts about the safety of the clutch. In this case:

- Have the clutch checked by a specialist workshop, preferably an authorised BMW motorcycle dealer.

Checking the clutch fluid level

 If the position of the clutch fluid reservoir is changed, air can enter the clutch system.

Do not twist either the handlebar controls or the handlebars. ◀

- Hold the motorcycle vertically or place it on the centre stand^{OA}, ensuring that the ground is firm and level.
- Straight ahead handlebar position.
- Read off the clutch fluid level at the reservoir.

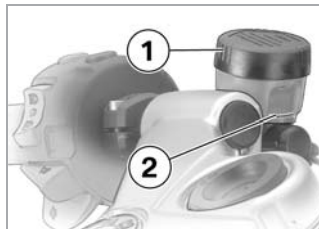

- 1 Clutch fluid reservoir
- 2 **MIN** mark

The clutch fluid level must not fall below the **MIN** mark. If the fluid level falls below the **MIN** mark, the clutch system must be checked immediately. If the clutch fluid level falls - even above the **MIN** mark - this indicates a defect in the clutch system.

- Have the fault remedied as soon as possible by a specialist workshop, preferably an authorised BMW motorcycle dealer.

 The fluid level in the reservoir falls as the clutch wears. ◀

 Unsuitable hydraulic fluids could cause damage to the clutch system. No fluids may be filled. ◀



The clutch system is filled with a special hydraulic fluid that does not require changing. ◀

Wheels

For each tyre size, certain tyre makes have been tested by BMW Motorrad, classified as safe for road traffic and approved. If BMW Motorrad has not approved the wheels and tyres, it cannot assess their suitability or provide any guarantee of road safety. Use only wheels and tyres approved by BMW Motorrad for your type of motorcycle. You can obtain detailed information from your authorised BMW motorcycle dealer or on the Internet at www.bmw-motorrad.com.

Checking the rims

- Place the motorcycle on the centre stand^{OA} or side stand, ensuring that the ground is firm and level.
- Perform a visual inspection to check for defective points.
- Have damaged rims checked and, if necessary, replaced by a specialist workshop, preferably an authorised BMW motorcycle dealer.

Checking the tyre tread depth

The minimum tyre tread depths legally prescribed in each country apply.



The handling characteristics of your motorcycle can deteriorate even before the legally prescribed minimum tread depth has been reached.



Have the tyres replaced before this minimum tread depth is reached. ◀



There is a wear indicating mark on each tyre, integrated in the main tread grooves. If the tyre tread has worn down to the level of the marks, the tyre is completely worn. The locations of the marks are indicated on the edge of the tyre, e.g. by the letters TI, TWI or by an arrow. ◀

- Only measure the tyre tread depth in the main tread grooves with wear indicating marks.

Removing the front wheel

 You will find an overview of the types of screw used on ( 124). ◀

 During the following work, parts of the front brake, in particular of the BMW Integral ABS, can be damaged.

Ensure that no parts of the brake system are damaged, in particular the ABS sensor with cable and the ABS sensor ring. ◀

Motorcycles without centre stands^{OA} :

To ensure a secure stance of the motorcycle during the following work:

- Place the motorcycle on the BMW Motorrad rear wheel stand ( 104).

- The rest of the procedure is the same as for motorcycles with centre stands.

Motorcycles with centre stands^{OA} :

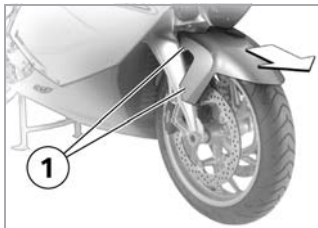

- Place the motorcycle on the centre stand^{OA}.
- Remove screws **1** on the left and right.
- Pull out the front wheel mudguard towards the front.

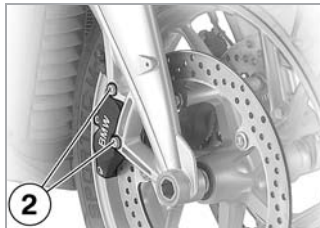

- Remove the mounting bolts **2** of the brake calipers on the left and right.

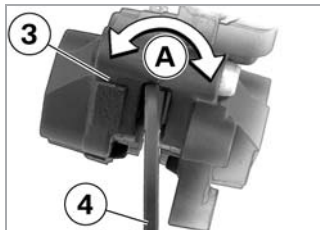

- Press the brake calipers **3** apart slightly using rotary motions **A** against the brake discs **4**.

 When removed, the brake pads can be pressed together to such a degree that they do not make contact with the brake disc on fitting.

Do not operate the handbrake lever when the brake calipers are removed. ◀

- Mask off areas of the rim that could be scratched on removal of the brake calipers.
- Pull the brake calipers backwards and outwards from the brake discs.

 If the motorcycle is on the centre stand^{OA}: If the front of the motorcycle is raised too far, the centre stand rises from the ground and the motorcycle can fall over sideways.

Make sure that the centre stand remains on the ground when the front is raised. ◀



- Lift the motorcycle using the BMW Motorrad front wheel stand (► 103) until the front wheel rotates freely.

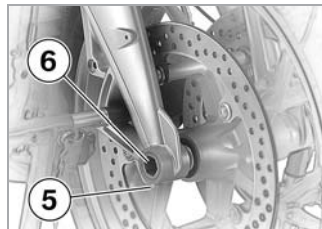

- Remove the right-hand axle clamping screw **5**.
- Remove the quick-release axle **6**, holding the wheel as you do so.

 Loosening or removing the left-hand axle clamping screw can lead to a failure of the ABS sensor. Do not loosen or remove the left-hand axle clamping screw. ◀

 BMW Motorrad provides an adapter for removing the quick-release axle. This adapter can be combined with any commercially available open-end or ring spanner with width across flats 22. The adapter with BMW special tool number 363690 can be obtained from your authorised BMW motorcycle dealer. ◀





- Place the front wheel in the front wheel guide on the ground.

- Roll out the front wheel forwards.

Installing the front wheel

 An overview of the types of screw used and the corresponding tightening torques can be found on [\(► 124\)](#). ◀

 Screw connections tightened to the incorrect torque can come loose or damage the screw connection itself. Make sure that you have the tightening torques checked by a specialist workshop, preferably by an authorised BMW motorcycle dealer ◀

 During the following work, parts of the front brake, in particular of the BMW Integral ABS, can be

damaged.

Ensure that no parts of the brake system are damaged, in particular the ABS sensor with cable and the ABS sensor ring. ◀

 The front wheel must be fitted in the direction of rotation.

Observe the direction of rotation arrows on the tyres or on the rim. ◀



- Roll the front wheel into the front wheel guide.

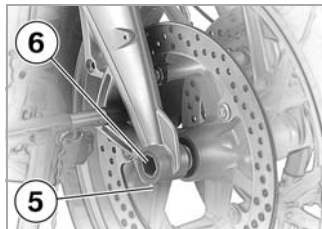

- Raise the front wheel, fit quick-release axle **6** and tighten to the appropriate tightening torque.
- Tighten right-hand axle clamping screw **5** to the appropriate tightening torque.
- Remove the front wheel stand.
- Fit the brake calipers onto the brake discs.

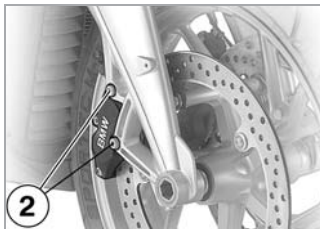

- Fit mounting bolts **2** of the brake calipers on the left and right and use the appropriate tightening torque.

 The ABS sensor cable could be abraded if it comes into contact with the brake disc. Ensure that the ABS sensor cable is routed tightly. ◀

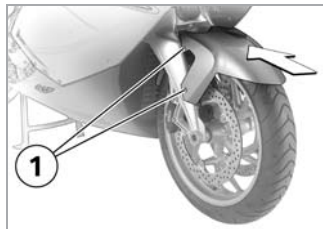

- Fit the mudguard and tighten the mounting bolts **1** to the appropriate tightening torque.
- Remove the masking from the rim.

To apply the brake pads to the brake discs, the front brake must be operated a number of times.

Without BMW Integral ABS:

- Press the handbrake lever firmly a number of times until the resistance point is noticeable.

With BMW Integral ABS:

- Switch on the ignition.
- Wait for the self-diagnosis (➡ 54).
- Press the handbrake lever firmly a number of times until the resistance point is noticeable.

 Brake pads that are not fully applied to the brake discs lead to delays in the braking effect. Before beginning a journey, check that the braking effect kicks in without any delay. ◀

Removing the rear wheel

 You will find an overview of the types of screw used on (➡ 124). ◀

Motorcycle without centre stand^{OA}:

To ensure a secure stance of the motorcycle during the following work:

- Place the motorcycle on the BMW Motorrad rear wheel stand (➡ 104).
- The rest of the procedure is the same as for motorcycles with centre stands.

Motorcycles with centre stands^{OA}:

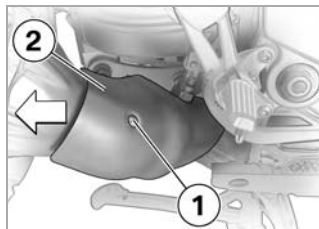

- Place the motorcycle on the centre stand^{OA}.
- Remove bolt **1** from silencer cover **2**.
- Pull off the cover towards the rear.

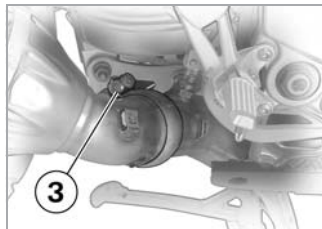

- Remove clamp **3** on the silencer.

 Do not remove the sealing grease from the clamp. ◀



- Remove bolt **4** of the end silencer bracket on the pillion footrest.
- Turn the end silencer outwards.
- Engage first gear.



- Remove mounting bolts **5** from the rear wheel, holding the wheel as you do so.
- If the BMW Motorrad rear wheel stand is used: remove the retaining disc.

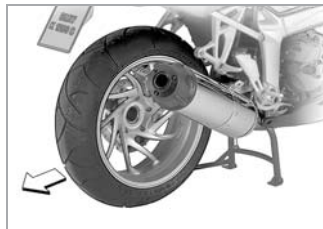

- Place the rear wheel on the ground.
- Roll the rear wheel out towards the rear.
- If the BMW Motorrad rear wheel stand is used: attach the retaining disc again.

Installing the rear wheel

 An overview of the types of screw used and the corresponding tightening torques can be found on [\(►► 124\)](#). ◀



Screw connections tightened to the incorrect torque can come loose or damage the screw connection itself.

Make sure that you have the tightening torques checked, preferably by an authorised BMW motorcycle dealer. ◀

- If the BMW Motorrad rear wheel stand is used: remove the retaining disc.

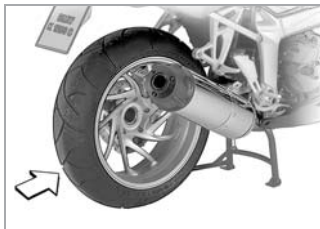

- Roll the rear wheel onto the rear wheel support.
- Place the rear wheel on the rear wheel support.
- If the BMW Motorrad rear wheel stand is used: attach the retaining disc again.



- Fit wheel bolts **5** and tighten crosswise to the appropriate tightening torque.



- Turn the end silencer into its initial position.
- Fit bolt **4** on the end silencer bracket to the pillion foot-rest, but do not tighten.

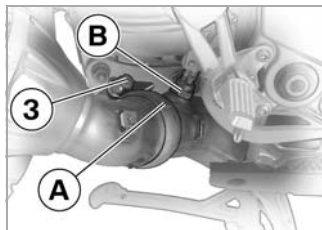

- Align clamp **3** on the end silencer with the mark **A** (arrow) on Lambda oxygen sensor **B**.
- Tighten clamp **3** on the end silencer to the appropriate tightening torque.



- Fit bolt **4** of the end silencer bracket to the pillion footrest and tighten to the correct tightening torque.

! If the gap between the rear wheel and the end silencer is too small, the rear wheel can overheat. The gap between the rear wheel and the end silencer must be at least 10 mm. ◀

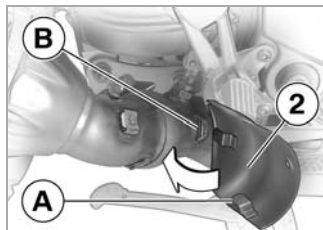

- Push silencer cover **2** with guides **A** into the brackets **B**.

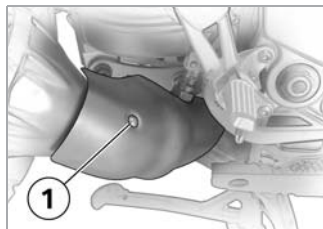

- Fit bolt **1** and tighten to the appropriate tightening torque.
- Remove any auxiliary stand.

Front-wheel stand

To enable simple and safe changing of the front wheel, BMW Motorrad provides a front wheel stand. The front wheel stand with BMW special tool number 363971 can be obtained from your authorised BMW motorcycle dealer. In addition, you require the adapters with BMW special tool number 363973.

Fitting the front wheel stand

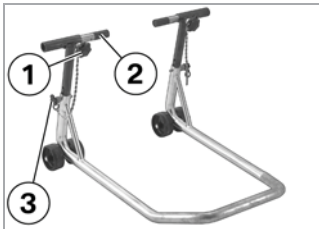

- Place the motorcycle on the centre stand^{OA} or suitable auxiliary stand, e.g. BMW Motorrad rear wheel stand (►► 104).
- Undo aligning screws **1**.
- Push the two mounting pins **2** far enough apart that the front wheel guide fits between them.
- Set the desired height of the front wheel stand using the locating pins **3**.
- Align the front wheel stand to the centre of the front wheel and push it onto the front axle.

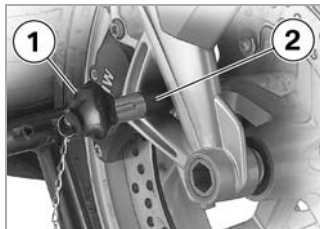

- Push the two mounting pins **2** through the triangles of the brake caliper support far enough that the front wheel can still be rolled through.

! In the case of BMW Integral ABS, the ABS sensor ring can be damaged. Only push the mounting pin so far inwards that it does not touch the sensor ring of the BMW Integral ABS. ◀

- Tighten aligning screws **1**.



- Press the front wheel stand evenly downwards to raise the motorcycle.

! If the motorcycle is on the centre stand^{OA}: If the front of the motorcycle is raised too far, the centre stand rises from the ground and the motorcycle can fall over sideways. When the front is raised, make sure that the centre stand remains on the ground. ◀

Rear wheel stand

In order to be able to work safely also on motorcycles without centre stands^{OA}, BMW Motorrad provides a rear wheel stand. The rear wheel stand with BMW special tool number 363980 can be obtained from your authorised BMW motorcycle dealer.

Mounting the rear wheel stand

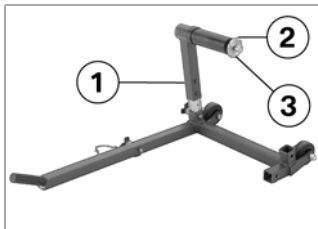

- Set the desired height of the rear wheel stand using the bolts **1**.
- Remove retaining disc **2**. To do so, press release button **3**.

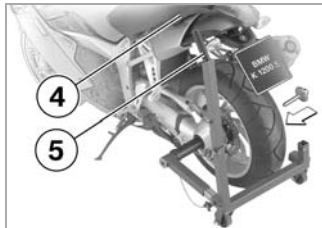

- Push the rear wheel stand from the left into the rear axle.
- Apply the retaining disc from the right; to do so, press the unlock button.

- Place your left hand on the left grab handle of the motorcycle **4**, and your right hand on the lever of the rear wheel stand **5**.



- Raise the motorcycle, simultaneously pressing the lever downwards until the motorcycle stands vertically.



- Press the lever onto the ground.

Bulbs

Information on bulbs

The failure of a bulb is signalled in the display by the defective lamp symbol. If the brake or rear light fails, the general warning light also lights up yellow.

If the rear light fails, the brake light is used as a substitute in

that the luminosity of the second glow filament is reduced to rear light level. Failure of the rear light is still shown in the display.

 In the event of a lamp failure, there can be problems seeing and being seen.

Replace defective bulbs as soon as possible; preferably always carry appropriate reserve lamps. ◀

 You will find an overview of the types of bulb used on (➡ 136). ◀

 Do not touch the glass of new bulbs with your fingers. Use a clean, dry cloth when fitting. Dirt deposits, in particular oil and grease, interfere with heat radiation from the bulb. This will result in overheating and therefore shorten the service life of the bulbs. ◀

 You will find an overview of the types of screw used on (➔ 124). ◀

Replacing the low-beam headlight bulb

 During the work described below, a motorcycle that has been parked unsafely can fall over. Make sure that the motorcycle is parked securely. ◀

 The bulb is pressurised, injuries may result if the bulb is damaged. Wear protective goggles and gloves when changing bulbs. ◀

 To achieve better accessibility, turn the handlebars to the right. ◀



- Pull off the connector **2**.

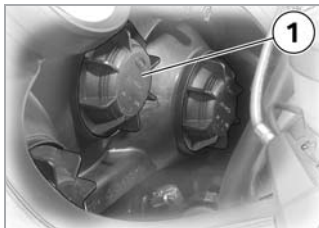

- If necessary, switch off the ignition.
- Loosen the cover **1** by turning it anticlockwise and remove it.



- Remove the spring wire brackets **3** from their detents on the left and right and fold them up.



- Remove the bulb **4**.

Assemble in reverse order.



- On assembly, make sure that the lug **5** points upwards.

Replacing the high-beam headlight bulb



During the work described below, a motorcycle that has been parked insecurely can fall over. Make sure that the motorcycle is parked securely. ◀



The bulb is pressurised, injuries may result if the bulb is damaged. Wear protective goggles and gloves when changing bulbs. ◀



To achieve better accessibility, turn the handlebars to the left. ◀



- 1** Cover High-beam headlight bulbs

- The high-beam headlight bulbs are changed in the same way as those of the low-beam headlight.

Replacing the parking light

 During the work described below, a motorcycle that has been parked insecurely can fall over. Make sure that the motorcycle is parked securely. ◀



- 1** Parking light
- 2** Access beneath the headlight

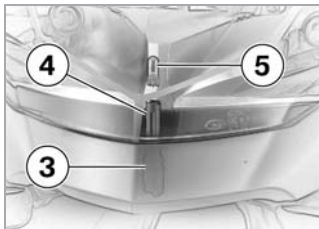

- 3** Connector
- 4** Bulb holder
- 5** Bulb

- If necessary, switch off the ignition.
- Pull off the connector **3** beneath the headlight.
- Remove the bulb holder **4** from the headlight housing by turning it anticlockwise.
- Pull the bulb **5** from the bulb holder.

Assemble in reverse order.

- To hold the new bulb, use a clean, dry cloth.

Replacing the brake light and rear light bulbs

 During the work described below, a motorcycle that has been parked insecurely can fall over. Make sure that the motorcycle is parked securely. ◀

- If necessary, switch off the ignition.
- Remove the seat (➡ 40).

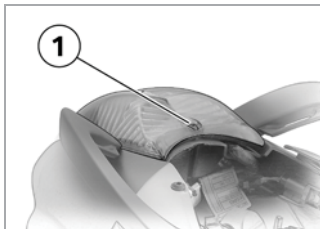

- Remove the bolt **1**.

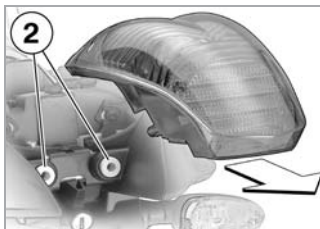

- Pull the lamp housing towards the rear from the brackets **2**.



- Remove the bulb holder **3** from the lamp housing by turning it anticlockwise.
- Press the bulb into the fitting and remove it by turning anticlockwise.

Assemble in reverse order.

- To hold the new bulb, use a clean, dry cloth.

Replacing the front turn signal lamp



During the work described below, a motorcycle that has been parked unsafely can fall over. Make sure that the motorcycle is parked securely. ◀

- If necessary, switch off the ignition.

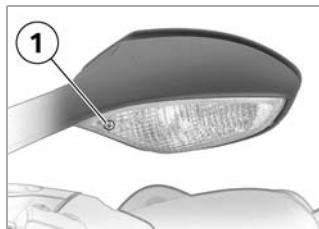

- Remove the bolt **1**.



- Pull the lamp housing on the screw connection side out of the mirror housing.

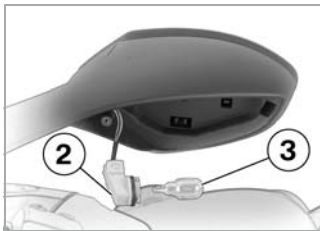

- Remove the bulb holder **2** from the lamp housing by turning it anticlockwise.
- Remove the bulb **3** from the bulb holder.

Assemble in reverse order.

- To hold the new bulb, use a clean, dry cloth.

Replacing the rear turn indicator bulb

 During the work described below, a motorcycle that has been parked insecurely can fall over. Make sure that the motorcycle is parked securely. ◀

- If necessary, switch off the ignition.

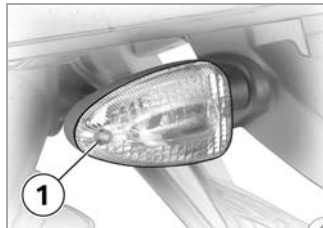

- Remove the bolt **1**.



- Pull the lamp housing on the screw connection side out of the turn indicator housing.

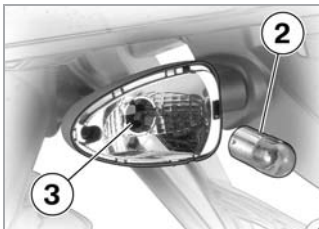

- Press bulb **2** into fitting **3** and remove by turning it anti-clockwise.

Assemble in reverse order.

- To hold the new bulb, use a clean, dry cloth.

Jump starting

 The wires leading to the power socket do not have a load-capacity rating adequate for jump-starting the engine. Excessively high current can lead to a cable fire or

damage to the vehicle electronics.

Do not use the on-board socket to jump-start the engine. ◀

 To start the engine, do not use start sprays or similar items. ◀

 Inadvertent contact between the terminal clips of the jump leads and the vehicle can lead to short circuits.

Only use jump leads with fully insulated battery-post clips. ◀

 Jump-starting with a voltage greater than 12 V can damage the vehicle electronics.

The battery of the other vehicle must have a 12 V system voltage. ◀

- Do not disconnect the battery from the vehicle electrical system when jump-starting.
- Remove the cover of the battery compartment.
- Let the engine of the donor vehicle run during the jump-starting process.
- First of all, use the red jump leads to connect the positive terminal of the discharged battery with the positive terminal of the donor battery.
- Then connect one end of the black jump lead to the negative terminal of the donor battery, and the other end to the negative terminal of the discharged battery.

- Start the engine of the vehicle with the discharged battery in the usual way; if the engine does not start, wait a few minutes before repeating the attempt in order to protect the starter and the donor battery.
- Allow both engines to idle for a few minutes before disconnecting the jump leads.
- Disconnect the jump lead from the negative terminals first, then disconnect the second lead from the positive terminals.
- Screw down the cover of the battery compartment.



Touching live parts of the ignition system with the engine running can lead to electric shocks.

Do not touch any parts of the ignition system when the engine is running. ◀

Battery

Maintenance information

Your motorcycle is supplied with a maintenance-free battery.

Correct upkeep, recharging and storage will prolong the life of the battery and are essential if warranty claims are to be considered.

Compliance with the points below is important in order to maximise battery life:

- Keep the surface of the battery clean and dry.
- Do not open the battery.
- Do not top up with water.
- Be sure to read and comply with the instructions for charging the battery on the following pages.
- Do not turn the battery upside down.



If the battery is not disconnected, the on-board electronics (clock, etc.) will drain the battery. This can cause the battery to run flat. If this happens, warranty claims will not be accepted. During immobilisation periods of more than four weeks, disconnect the battery from the motorcycle or connect a trickle charger to the battery. ◀

 BMW Motorrad has developed a trickle-charger specially designed for compatibility with the electronics of your motorcycle. Using this charger, you can keep the battery charged during long immobilisation periods without having to disconnect the battery from the motorcycle's on-board systems. You can obtain additional information from your authorised BMW motorcycle dealer. ◀

Charging the battery when connected

If you switch on the ignition and the multifunction display and telltale lights fail to light up, the battery is completely flat.

- Charge the disconnected battery via the power socket.
- Comply with the operating instructions of the charger.

 Charging a completely discharged battery via the on-board socket can result in damage to the motorcycle electronics.

A battery which is completely discharged must always be charged directly at the terminals of the disconnected battery. ◀

 Charging the connected battery directly at the battery terminals can damage the vehicle electronics.

To charge the battery via the battery terminals, disconnect the battery first. ◀

 The motorcycle's on-board electronics know when the battery is fully charged. In this case, the power socket is switched off. ◀

 The BMW chargers with item numbers 71 607 676 472 and 72 607 679 040 are not suitable for charging this motorcycle via the power socket. In unfavourable cases, the devices can be destroyed. We recommend that you obtain information on suitable chargers from your authorised BMW motorcycle dealer. ◀

 If you are unable to charge the battery via the power socket, you may be using a charger that is not compatible with your motorcycle's electronics. In this case, please charge the battery directly at the terminals of the disconnected battery. ◀

Charging the disconnected battery

 In the case of longer immobilisation periods, the battery must be recharged regularly.

In this connection, comply with the instructions for the battery. Always fully recharge the battery before restoring it to use. ◀

- Charge the battery using a suitable charger.
- Comply with the operating instructions of the charger.
- Once the battery is fully charged, disconnect the charger terminal clips from the battery terminals.

Removing the battery

 You will find an overview of the types of screw used on (➔ 125). ◀

 During the work described below, a motorcycle that has been parked unsafely can fall over. Make sure that the motorcycle is parked securely. ◀

- If necessary, switch off the ignition.

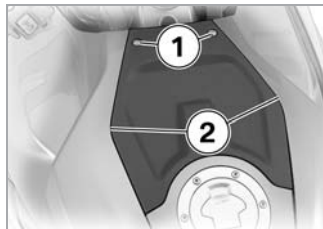

- Remove screws **1**.

 The battery compartment lid is locked at positions **2**. ◀

- Release the battery compartment lid from catches **2** one by one.
- Take out the battery compartment lid in a forward and upward direction.

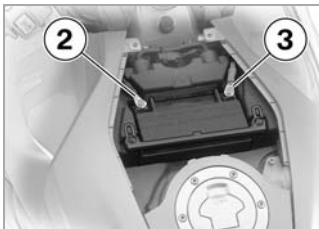

- Remove negative battery lead **2** first.
- Then remove the positive battery lead **3**.

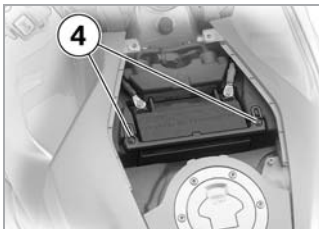

- Undo screws **4** and pull the retaining bracket backwards.

- Lift the battery upwards; if it is difficult to move, moving it back and forth will help.

Installing the battery

 An overview of the types of screw used and the corresponding tightening torques can be found on (►► 125).◀

 During the work described below, a motorcycle that has been parked unsafely can fall over.

Make sure that the motorcycle is parked securely.◀

- If necessary, ignition key in the "ignition off" position.
- Place the battery in the battery compartment, positive terminal on the right in the direction of travel.

- Push the retaining bracket over the battery; tighten the screws to the appropriate tightening torque.
- Fit the positive battery lead first of all; tighten to the appropriate tightening torque.
- Then fit the negative battery lead; tighten to the appropriate tightening torque.
- Fit the battery compartment lid; tighten the screws to the appropriate tightening torque.
- Switch on the ignition.
- Fully open the throttle once or twice.
 - » The engine management system records the throttle-valve position.

 After connecting the battery, the time must be reset.◀

Splash guard

A splash guard is supplied with the motorcycle; if required, this can be fitted to the number plate holder.

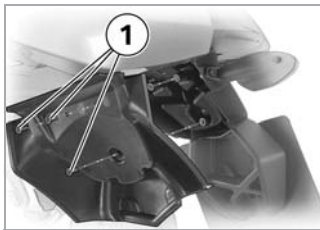

- Use screws **1** to fit the splash guard onto the number plate holder from below.

Cleaning and care	118
Laying up.....	120
Restoring to use	121

Cleaning and care

Regular cleaning, using the correct methods, is an important factor in maintaining the value of your motorcycle. It also ensures that safety-relevant parts remain in full working order.

Care products

We recommend that you use the cleaning and care products you can obtain from your authorised BMW motorcycle dealer. The materials in BMW Care Products have been tested in laboratories and in practice; they provide optimised care and protection for the materials used in your vehicle.



The use of unsuitable cleaning and care products can damage vehicle components.

For cleaning, do not use any solvents such as nitro-thinners, cold cleaning agents, fuel or similar, and do not use cleaning agents that contain alcohol. ◀

Washing the motorcycle

We recommend that you use BMW insect remover to soften and wash off insects and resilient dirt on painted parts prior to washing the motorcycle. To prevent stains, do not wash the motorcycle immediately after it has been exposed to strong sunlight and do not wash it in the sun.

Make sure that the motorcycle is washed frequently, especially during the winter months.

To remove road salt, clean the motorcycle with cold water immediately after every trip.



Warm water reinforces the effects of the salt. Only use cold water to remove road salt. ◀



Wet brake discs reduce the braking effect. After washing the motorcycle, dry the brakes by braking. ◀



The high water pressure of steam jet cleaners can damage gaskets, the hydraulic brake system and the electrical equipment.

Do not use steam jet cleaners or high-pressure cleaners. ◀

Plastics

Clean plastic parts with water and BMW plastic care emulsion. This includes in particular:

- Windscreens
- Headlight lenses made of plastic
- Covering glass of the instrument cluster
- Black, unpainted parts

 If plastic parts are cleaned using unsuitable cleaning agents, the surfaces can be damaged.

Do not use cleaning agents that contain alcohol, solvents or abrasives to clean plastic parts. "Fly sponges" or sponges with hard surfaces can also lead to scratches. ◀



Soften resilient dirt and insects by applying a wet cloth. ◀

Windscreen

Remove dirt and insects with a soft sponge and lots of water.



Fuel and chemical solvents attack the windscreen.

Do not use cleaning agents. ◀

Chrome

Especially in the case of road salt, carefully clean chrome with plenty of water and BMW vehicle shampoo. Use chrome polish for additional treatment.

Radiator

Clean the radiator regularly to prevent overheating of the engine due to inadequate

cooling. For example, use a garden hose with low water pressure.



Cooling fins can be bent easily.

When cleaning the radiator, ensure that the fins are not bent. ◀

Paint care

Regular washing of the motorcycle counteracts the long-term effects of materials that damage the paint, especially if your motorcycle is ridden in areas with high air pollution or natural sources of dirt, e.g. tree resins or pollen.

However, remove particularly aggressive materials immediately; otherwise changes in the paint or discolouration can occur. These include, e.g., spilled fuel, oil, grease, brake

fluid as well as bird droppings. BMW vehicle polish or BMW paint cleaner are recommended here.

Contamination on the paint finish is particularly easy to see after the motorcycle has been washed. Remove stains of this kind immediately using cleaning-grade benzine or petroleum spirit on a clean cloth or ball of cotton wool. We recommend that specks of tar be removed with BMW tar remover. Then add a protective wax coating to the paint at these locations.

Protective wax coating

For the protective wax coating of paint, we recommend that you use only BMW vehicle wax or agents that contain carnauba wax or synthetic waxes.

The best way to see whether the paint has to be protected is that water no longer forms pearls.

Touching up

Your authorised BMW motorcycle dealer is equipped with suitable systems for rapid and low-cost correction of minor paint damage. We recommend that minor paintwork flaws be rectified with a BMW paint spray or a BMW paint pencil and larger paint damage be dealt with at your authorised BMW motorcycle dealer by a specialised repair paint job carried out in accordance with works specifications with original BMW paints.

Rubber

Treat rubber components with water or BMW rubber protection coating agent.



The use of silicon sprays to care for rubber gaskets can lead to damage. Do not use silicon sprays or other care products that contain silicon. ◀

Laying up

- Clean the motorcycle (➡ 118-120).
- Remove the battery (➡ 114).
- Spray the brake and clutch lever pivots and the main and side stand pivots with a suitable lubricant.
- Coat bright metal/chrome-plated parts with an acid-free grease (e.g. Vaseline).

- Place the motorcycle in a dry room on the centre stand^{OA} or rear wheel stand.
- Raise the engine with the front wheel stand in such a way that both wheels are without load.
- Install a charged battery (➡ 115).
- Perform the safety checks (➡ 52).
- Check the brakes (➡ 89-91).
- Check the tyre pressures (➡ 47).

 Before laying the vehicle up, have the engine oil and the oil filter element changed by a specialist workshop, preferably your authorised BMW motorcycle dealer. Combine work for laying up/restoring to use with a maintenance service or inspection. ◀

Restoring to use

- Remove the protective wax coating.
- Clean the motorcycle (➡ 118-120).

Bolt connections	124
Tyre pressures	126
Engine	127
Power transmission	128
Frame and suspension	129
Wheels and tyres.....	131
Fuel and lubricants	132
Electrical system.....	135
Dimensions and weights	137
Riding specifications	138

Bolt connections

Activity	Type of bolt connection	Tightening torque
Front wheel		
Mudguard	Internal TORX [®] T25 (1)	hand-tight
Brake caliper	Internal TORX [®] T45	30 Nm
Axle clamping screw	Internal TORX [®] T40	19 Nm
Quick-release axle	Allen screw w/f 22	50 Nm
Rear wheel		
Clip cover	Internal TORX [®] T25 (1)	hand-tight
End silencer to footrest	Internal TORX [®] T45	16 Nm
Clamp on end silencer	Internal TORX [®] T45	35 Nm
Rear wheel	Internal TORX [®] T50	60 Nm
Lamp housing		
Brake and rear light	Phillips screw, large (1)	hand-tight
Front turn indicators	Phillips screw, large (1)	hand-tight
Rear turn indicators	Phillips screw, small (1)	hand-tight

Bolt connections

Activity	Type of bolt connection	Tightening torque
Battery		
Battery compartment lid	Internal TORX® T25 (1)	hand-tight
Battery-terminal clamps	External hexagon w/f 10 or slotted head screw, large (1)	hand-tight
Securing bracket	Internal TORX® T20	hand-tight
Splash guard		
Splash guard	Internal TORX® T25 (1)	hand-tight

(1) in the toolkit

Tyre pressures

Tyre pressures measured when tyres are cold.

Loading	Front	Rear
Solo operation	2.5 bar	2.9 bar
Solo operation with luggage	2.5 bar	2.9 bar
Operation with pillion passenger (and luggage)	2.5 bar	2.9 bar

Engine

Engine

Type	4-cylinder in-line engine, fitted crossways, inclined 55°
Displacement	1,157 cm ³
Bore/stroke	79/59 mm
Compression ratio	13 : 1

Power output

Greatest rated power	123 / 74 kW
- at engine speed	10,250 / 7,000 rpm

Torque

Max. torque	130 / 110 Nm
- at engine speed	8,250 / 5,250 rpm

Engine speeds

Engine speed, maximum	11,000 rpm
Neutral speed	1,150 ± 50 rpm

Consumption

Fuel consumption at constant 90 km/h	4.7 l/100 km
Fuel consumption at constant 120 km/h	5.5 l/100 km
Maximum oil consumption	1 l/1,000 km

Power transmission

Clutch

Type	Hydraulic multi-disc wet clutch
Clutch disc diameter	172 mm

Transmission

Type	6-speed gearbox
Overall ratios	1st gear = 3.93 2nd gear = 2.87 3rd gear = 2.27 4th gear = 2.01 5th gear = 1.78 6th gear = 1.582

Rear-wheel drive

Power transmission from gearbox to rear-wheel drive	Universal shaft with integrated torsional damper
Rear-wheel drive	Bevel gears
Rear axle transmission	1 : 2.82

Frame and suspension

Frame

Type	Main and rear frame in light-alloy design
Location of type plate	on the rear cross frame tube
Location of vehicle identification number (VIN)	on the side frame section at the front right

Front brake

Type	two floating brake discs with 4-piston fixed calipers sintered metal brake pads
------	---

Rear brake

Type	one fixed brake disc with 2-piston floating caliper organic brake pads
------	---

Front wheel guide

Type	BMW Duolever
Steering lock angle	2 x 29°
Front wheel castor in normal-load position	111.63 mm

Rear wheel guide

Type	BMW EVO Paralever swinging arm
------	--------------------------------

Frame and suspension

Front suspension system

Type	Central suspension strut with single-tube gas pressure shock absorber
Spring travel (bump)	60 mm
Spring travel (rebound)	55 mm
Total suspension travel	115 mm

Rear suspension system

Type	Central suspension strut with single-tube gas pressure shock absorber Spring preload and rebound-stage damping infinitely variable
Spring travel (bump)	100 mm
Spring travel (rebound)	35 mm
Total suspension travel (at wheel)	135 mm

Wheels and tyres

Front wheel

Type	MTH2 angled rim shoulder with double tyre retaining hump
Rim size	3.50 x 17"
Tyre size	120/70-ZR17

Rear wheel

Type	MTH2 angled rim shoulder with double tyre retaining hump
Rim size	6.00 x 17"
Tyre size	190/50-ZR17

Fuel and lubricants

Engine

Engine oil

Brand-name HD oil of API classification SF, SG or SH; CD or CE amendments are permissible; or brand-name HD oil of CCMC classification G4 or G5; amendment PD2 is permissible. Engine oils of viscosity grades SAE 20W-x may not be used.

Do not use synthetic engine oils unless they have been approved by BMW for this vehicle.

Top-up volume between MIN and MAX

0.5 l

BMW recommends Castrol



Fuel and lubricants

Viscosity classes depending on outside temperature

0 °C – 30 °C	SAE 30
20 °C – above 30 °C	SAE 40
-15 °C – above 30 °C	SAE 15 W-50
-15 °C – 30 °C	SAE 15 W-40
-20 °C – 20 °C	SAE 10 W-40
-20 °C – 10 °C	SAE 10 W-30
-20 °C – above 30 °C	SAE 10 W-X ($X \geq 40$)
below -30 °C – above 30 °C	SAE 5 W-X ($X \geq 40$)

Oils with $x \geq 40$ are available from your authorised BMW motorcycle dealer.

All engine oils supplied by BMW Motorrad are subject to regular BMW quality assurance checks.

Oil additives are not required and are not recommended.

It is not permitted to mix different engine oils.

Fuel and lubricants

Transmission

Transmission oil	joint oil circuit with engine
------------------	-------------------------------

Fuel

Fuel grade	Premium grade unleaded fuel (98 ROZ/RON; 88 MOZ/MON)
------------	---

Content of fuel tank	19 l
----------------------	------

Reserve volume	4 l
----------------	-----

Brakes

Brake fluid	DOT 4 We recommend BMW brake fluids
-------------	--

Electrical system

Battery

Type	12 V 14 Ah, maintenance-free
Low temperature test current	190 A

Spark plugs

Approved spark plugs	BOSCH YR 5DDE
Electrode gap	0.7 mm
Wear limit	1.0 mm

Fuses

All circuits are electronically protected, so plug-in fuses are no longer necessary. If an electronic fuse trips and de-energises a circuit, the circuit is active as soon as the ignition is switched on after the fault has been rectified.

Electrical system

Bulbs

Design of headlight	Clear glass with three reflectors
High-beam headlight	2 H7 halogen bulbs, 12 V 55 W
Low-beam headlight	H7 halogen bulb 12 V 55 W
Parking light	12 V 5 W
Brake/rear lights	12 V 21/5 W
Front turn indicators	12 V 16 W
Rear flashing turn indicators	12 V 10 W

Power socket

Ratings	12 V 5 A
---------	----------

Dimensions and weights

Dimensions

Maximum length	2,214 mm
Maximum width	858 mm
Maximum height (without rider)	1,220 mm
Seat height	820 mm
Wheelbase in normal-load position	1,572 mm
Ground clearance in normal-load position	120 mm

Weights

DIN unladen weight	248 kg
Permissible gross weight	450 kg
Maximum payload	202 kg

Permissible wheel loads

Front	160 kg
Rear	290 kg

Riding specifications

Speeds

Top speed	over 200 km/h
Acceleration 0-100 km/h	2.8 s

Noises

Riding noise to EU specification	80 dB (A)
Stationary noise to EU specification	94 dB (A) at 5,100 rpm

BMW Motorrad service	140
Confirmation of maintenance work.....	143
Confirmation of service	147

BMW Motorrad service

BMW Motorrad service quality

BMW Motorrad stands not only for good handling and a high degree of reliability, but also for an excellent quality of service. To ensure that your BMW is always in optimum condition, we recommend that you have the regular maintenance work required for your motorcycle carried out and that you have this done preferably at your authorised BMW motorcycle dealer. For goodwill services after the expiry of the warranty, proof of regular maintenance is an indispensable precondition. Certain signs of wear, moreover, may otherwise not be noticed until it is too late to rectify them at moderate cost. Your authorised BMW

motorcycle dealer knows your motorcycle intimately and can step in before small problems become extremely serious issues. By having the necessary repairs done properly and in good time, you save time and money in the long run.

BMW Motorrad Service Card – On-the-spot breakdown assistance

With all new BMW motorcycles, the BMW Motorrad Service Card protects you in the event of a breakdown with an extensive range of services such as breakdown assistance, motorcycle transportation etc. (differing regulations are possible in individual countries).

In the event of a breakdown, contact BMW Motorrad's Mobile Service. Here you will

find our specialists ready to help in both word and deed.

Important country-specific contact addresses and the relevant after-sales service organisation phone numbers as well as information on Mobile Service and the dealership network can be found in the "Service Kontakt / Service Contact" brochures.

BMW Motorrad service network

Our extensive after-sales service organisation network is able to look after you and your motorcycle in more than 100 countries. In Germany alone, you have the best possible access to approximately 200 authorised BMW motorcycle dealers.

All information concerning the international dealership network can be found in the brochure "Service Contact Europe" or "Service Contact Africa, America, Asia, Australia, Oceania".

You will be given the relevant brochure for your country together with your motorcycle; you can obtain both brochures from your authorised BMW motorcycle dealer.

Maintenance work

Maintenance work is performed on the basis of time and distance travelled.

BMW running-in check

The BMW running-in check has to be performed when the motorcycle has covered between 500 km and 1,200 km

BMW Annual Inspection

Some maintenance work has to be carried out at least once a year. Other tasks depend on the distance the motorcycle has covered.

BMW Service

After the first 10,000 km and every further 20,000 km (30,000 km, 50,000 km, 70,000 km, etc.) if this distance is covered within a year.

BMW Inspection

After the first 20,000 km and every further 20,000 km (40,000 km, 60,000 km, 80,000 km, etc.) if this distance is covered within a year.

Maintenance schedules

If you like, you can view the current maintenance schedule for your motorcycle on the Internet and download the file from www.bmw-motorrad.com/maintenance.

 Every authorised BMW motorcycle dealer has a fixed scale of charges based on labour times and carefully calculated hourly rates. Lubricants and operating materials, filters, gaskets etc. are charged separately. ◀

BMW Pre-delivery Check

Carried out in accordance with
manufacturer's instructions

Date, stamp, signature

BMW Running-In Check

Carried out in accordance with
manufacturer's instructions

Odometer
reading _____

Brake fluid changed:

- Without BMW Integral ABS
- With BMW Integral ABS
 - Wheel circuit
 - Control circuit

Date, stamp, signature

Confirmation of maintenance work

BMW Service

- BMW Annual Inspection
- BMW Service
- BMW Inspection

Carried out in accordance with manufacturer's instructions

Odometer reading _____

Brake fluid changed:

- Without BMW Integral ABS

- With BMW Integral ABS
 - Wheel circuit
 - Control circuit

Date, stamp, signature

BMW Service

- BMW Annual Inspection
- BMW Service
- BMW Inspection

Carried out in accordance with manufacturer's instructions

Odometer reading _____

Brake fluid changed:

- Without BMW Integral ABS

- With BMW Integral ABS
 - Wheel circuit
 - Control circuit

Date, stamp, signature

BMW Service

- BMW Annual Inspection
- BMW Service
- BMW Inspection

Carried out in accordance with manufacturer's instructions

Odometer reading _____

Brake fluid changed:

- Without BMW Integral ABS

- With BMW Integral ABS
 - Wheel circuit
 - Control circuit

Date, stamp, signature

Confirmation of maintenance work

BMW Service

- BMW Annual Inspection
- BMW Service
- BMW Inspection

Carried out in accordance with manufacturer's instructions

Odometer reading _____

Brake fluid changed:

- Without BMW Integral ABS

- With BMW Integral ABS
 - Wheel circuit
 - Control circuit

Date, stamp, signature

BMW Service

- BMW Annual Inspection
- BMW Service
- BMW Inspection

Carried out in accordance with manufacturer's instructions

Odometer reading _____

Brake fluid changed:

- Without BMW Integral ABS

- With BMW Integral ABS
 - Wheel circuit
 - Control circuit

Date, stamp, signature

BMW Service

- BMW Annual Inspection
- BMW Service
- BMW Inspection

Carried out in accordance with manufacturer's instructions

Odometer reading _____

Brake fluid changed:

- Without BMW Integral ABS

- With BMW Integral ABS
 - Wheel circuit
 - Control circuit

Date, stamp, signature

Confirmation of maintenance work

BMW Service

- BMW Annual Inspection
- BMW Service
- BMW Inspection

Carried out in accordance with manufacturer's instructions

Odometer reading _____

Brake fluid changed:

- Without BMW Integral ABS

- With BMW Integral ABS
 - Wheel circuit
 - Control circuit

Date, stamp, signature

BMW Service

- BMW Annual Inspection
- BMW Service
- BMW Inspection

Carried out in accordance with manufacturer's instructions

Odometer reading _____

Brake fluid changed:

- Without BMW Integral ABS

- With BMW Integral ABS
 - Wheel circuit
 - Control circuit

Date, stamp, signature

BMW Service

- BMW Annual Inspection
- BMW Service
- BMW Inspection

Carried out in accordance with manufacturer's instructions

Odometer reading _____

Brake fluid changed:

- Without BMW Integral ABS

- With BMW Integral ABS
 - Wheel circuit
 - Control circuit

Date, stamp, signature

Confirmation of maintenance work

BMW Service

- BMW Annual Inspection
- BMW Service
- BMW Inspection

Carried out in accordance with manufacturer's instructions

Odometer reading _____

Brake fluid changed:

- Without BMW Integral ABS
- With BMW Integral ABS
 - Wheel circuit
 - Control circuit

Date, stamp, signature

BMW Service

- BMW Annual Inspection
- BMW Service
- BMW Inspection

Carried out in accordance with manufacturer's instructions

Odometer reading _____

Brake fluid changed:

- Without BMW Integral ABS
- With BMW Integral ABS
 - Wheel circuit
 - Control circuit

Date, stamp, signature

BMW Service

- BMW Annual Inspection
- BMW Service
- BMW Inspection

Carried out in accordance with manufacturer's instructions

Odometer reading _____

Brake fluid changed:

- Without BMW Integral ABS
- With BMW Integral ABS
 - Wheel circuit
 - Control circuit

Date, stamp, signature

Confirmation of service

The list is intended as a record of maintenance, warranty and repair work, the installation of optional accessories and, if appropriate, special campaign (recall) work.

Record of all work carried out in workshop		
Work details	km	Date

A

Abbreviations, 4

ABS

Braking power assistance, 70

partial integral braking, 70

Rising rear wheel, 71

Self-diagnosis, 54

Warning indicator, 25

Warning light, 19

Accessories

BMW optional extras, 4

Cable routing, 75

General instructions, 74

Non-BMW products, 6

Operation from the power socket, 75

Accessory

BMW optional accessories, 4

Adjusting mirrors, 43

Adjusting the rear shock absorber, 44

Adjusting the rear spring preload, 43

Adjusting the vertical aim, 38

B

Battery

Battery compartment, 11

Charging when

connected, 113

Charging when

disconnected, 114

Maintenance instructions, 112

Removing, 114

Technical data, 135

Warning indicator for charge current, 24

BMW Service

Annual inspection, 141

Confirmation of maintenance work, 143

Confirmation of service, 147

Information, 6

Inspection, 141

Maintenance schedules, 141

Maintenance service, 141

Running-in check, 141

Service Card, 140

Worldwide, 140

Bolt connections, 124

Brake

Adjusting the handbrake lever, 36

Front fluid tank, 11

Rear fluid reservoir, 11

Safety instructions, 68

Brake light

Replacing the bulb, 108

Brake pads, 58

Brakes

Brake pads, 90

Checking the brake pad thickness at the front, 90

Checking the brake pad thickness at the rear, 91

Checking the fluid level, 91

Checking the function, 89

Bulbs

Information, 105

Technical data, 136

Warning indicator defective lamp, 24

C

Care

- Care products, 118
- Chrome, 119
- Paint, 119
- Plastics, 119
- Protective wax coating, 120
- Radiator, 119
- Rubber, 120
- Touching up, 120
- Washing the motorcycle, 118
- Windscreen, 119

Cases

- Adapting, 81
- Adjusting the volume, 80
- Closing, 79
- Correct loading, 77
- Fitting, 80
- Key positions, 77
- Opening, 78
- Release levers, 77
- Removing, 81

- Catalytic converter, safety information, 51

Centre stand

- Extending, 65
 - Folding in, 67
- Checklist, 52
- Clock
- Adjusting, 14, 35
 - Display, 18
- Clutch
- Checking the fluid level, 93
 - Checking the function, 93
 - Fluid reservoir, 9

Coolant

- Checking the level, 88
- Filler aperture, 9
- Temperature display, 18
- Temperature warning, 22
- Topping up, 89

Currency, 5

D

- DWA telltale light, 14

E

- Engine, 132

Engine electronics

- Manipulation of the engine electronics control unit, 51
- Warning indicator, 23

Engine oil

- Checking the oil level, 11, 86
- Draining off, 88
- Technical data, 132
- Topping up, 87
- Warning indicator for oil pressure, 23

Engine, technical data, 127

ESA

- Adjusting the shock absorbers, 46
- Adjusting the spring preload, 47
- Calling up settings, 46
- Explanations, 45
- Operation, 12

EWS

- Display, 22
- Explanations, 31

F

Front-wheel stand, 103

Fuel

Filler aperture, 11

Fuel gauge, 18

Quality, 68, 134

Refuelling, 67

Reserve display, 22

Fuel tank capacity, 68

Fuses, 135

G

Gear indicator, 18

Gearbox

Gear shifts, 59

Position on starting, 53

Technical data, 128

General view

Left side, 9

Right side, 11

Grip heating, 13, 35

H

Handlebar controls

Left, 12

Right, 13

Hazard warning

flashers, 12, 32, 33

Headlight

Adjustment for right-hand/left-hand traffic, 38

Overview, 15

Headlight flasher, 12, 37

Headlights

Adjusting the vertical aim, 9

Helmet holder, 9, 41

High-beam headlight

Bulb, 15

Replacing the bulb, 107

Switching on, 12, 37

Telltale light, 18

Horn, 12

I

Ignition

Switching off, 30

Switching on, 30, 53

Inflation pressures, 126

Installing the battery, 115

Instrument cluster, 14

J

Jump starting, 111

K

Keys

Ignition keys, 30

Replacement keys, 32

Kill switch, 13, 34

L

Laying up, 120

Low-beam headlight

Bulb, 15

Replacing the bulb, 106

Switching on, 37

Luggage

- Safety information, 50

- Strapping, 42

M

- Motorcycle equipment, 5

- Multifunction display, 14

N

- Neutral, telltale light, 18

P

- Parking light, 38

- Bulb, 15

- Replacing the bulb, 108

- Parking your motorcycle, 61, 65

- Power socket, 9, 74, 136

- Pre-ride check, 53

R

- Rear light, replacing the

- bulb, 108

- Rear shock absorber

- adjustment, 9

- Rear spring preload

- adjustment, 9

- Rear wheel stand, 104

- Replacement keys, 32

- Resetting the odometer, 34

- Residual braking function, 71

- Residual range, 34

- Restoring to use, 121

- Rev. counter, 14

- Rider's equipment, 6

- Running in

- Brake pads, 58

- General information, 58

S

- Safety check before a

- journey, 52

- Safety instructions, 50

- Seat

- Installing, 41

- Lock, 9

- Placing down, 40

- Removing, 40

- Securing the steering lock, 31

- Sensor for instrument cluster

- lighting, 14

- Shifting gear, 59

- Side stand

- Folding in, 63

- Position on starting, 55

- Unfolding, 61

- Spark plugs, technical data, 135

- Speed

- Safety information, 50

- Technical data, 138

- Speedometer, 14

- Splash guard, 116

- Starter, 13

- Starting, 56

- Symbols, 4

T

- Technical data

- Bolt connections, 124

- Dimensions and weights, 137

- Electrical system, 135

- Engine, 127

- Frame and suspension, 129
- Fuel and lubricants, 132
- Information, 5
- Power transmission, 128
- Riding specifications, 138
- Wheels, 131
- Telltale lights, 14, 18
- Tightening torques, 124
- Toolkit, 11, 85
- Tripmaster, 12, 18, 33
- Turn indicator
 - Left, 12
 - Replacing the front bulb, 109
 - Replacing the rear bulb, 110
 - Right, 13
- Turn indicators
 - Switching off, 13, 40
 - Switching on, 39
 - Telltale lights, 18
- Type plate, 11

V

- Vehicle identification number, 11

W

- Warning indicators
 - Notes, 19
 - Overview, 20
- Warning lights, 14, 18
- Warnings, 4
- Wheels
 - Checking the rims, 94
 - Checking the tread depth, 94
 - Checking the tyre pressure, 47
 - Fitting the front wheel, 97
 - Fitting the rear wheel, 100
 - Makes, 94
 - Removing the front wheel, 95
 - Removing the rear wheel, 99
 - Technical data, 131
 - Tyre pressures, 126

Vehicle/dealership data

Vehicle data

Model

Vehicle identification number

Colour code

First registration

Registration number

Dealership data

Person to contact in Service

Ms./Mr.

Phone number

Dealership address/phone
(company stamp)

Details described or illustrated in this booklet may differ from the motorcycle's actual specification as purchased, the accessories fitted or the national-market specification. No claims will be entertained as a result of such discrepancies.

Dimensions, weights, fuel consumption and performance data are quoted to the customary tolerances.

The right to modify designs, equipment and accessories is reserved.

Errors and omissions excepted.

© 2004 BMW Motorrad

Not to be reproduced either wholly or in part without written permission from BMW Motorrad, After Sales.
Printed in Germany

The most important data for a filling station stop can be found in the following chart:

Fuel		
Designation	Premium grade unleaded fuel	
ROZ/RON	98	
MOZ/MON	88	
Fuel tank capacity	19 l	
Tyre pressures	Front	Rear
One-up	2.50 bar	2.90 bar
Solo operation with luggage	2.50 bar	2.90 bar
Operation with pillion passenger (and luggage)	2.50 bar	2.90 bar

BMW Motorrad

Order No.:
01 41 7 694 791
09.2004
2nd edition GB / RF



The Ultimate
Driving Machine

About BMW Motorrad Integral ABS

How does ABS work?

The maximum braking force it is possible to transfer to the carriageway depends, among other things, on the road surface's coefficient of friction. Gravel, ice and snow, and water on the road, have significantly poorer coefficients of friction than a dry, clean asphalt road surface. The poorer the road's coefficient of friction, the longer the braking distance.

If the maximum braking force it is possible to apply to the road is exceeded when the rider increases brake pressure, the wheels will begin to lock and directional stability is lost; a fall threatens. Before this situation can arise, ABS intervenes and

adapts the braking pressure to the maximum braking force it is possible to transfer so that the wheels continue to turn and driving stability is maintained whatever the prevailing road conditions.

What happens with bumps in the road?

Corrugated road surfaces or bumps in the road can cause the tyres to temporarily lose contact with the road surface and hence the braking force it is possible to apply to drop to zero. If the brakes are applied in this situation, the ABS must reduce the braking pressure to ensure driving stability when contact with the road surface is restored. At this moment, BMW Motorrad Integral ABS

must assume extremely low coefficients of friction (gravel, ice, snow) so that the wheels turn in any conceivable situation and thus the stability of the motorcycle is ensured. Once the actual circumstances are detected, the system will set the brake pressure to the optimum value.

What do we observe during rider safety training?

Braking in which ABS has to intervene has, by comparison with normal braking, a significantly higher demand for electricity which puts a heavy load on the battery. The battery is constantly being charged in normal riding so that it always has sufficient capacity available.

If the motorcycle is not to be ridden for several weeks, a trickle charger, which can be obtained from your BMW Motorrad dealer, should be connected or the battery disconnected and then recharged before starting riding again.

During rider safety training, an unusual number of ABS-controlled braking operations take place in rapid succession interspersed with periods of waiting and assessment in which the motorcycle is not being ridden. The battery is put under heavy load by the ABS control actions, but at the same time it is not being recharged as practically no riding is being done.

In isolated cases, in this artificially created situation,

braking operations in which the brake lever is operated with maximum force and extreme speed, in combination with declining on-board supply voltage, can bring the ABS up to its technical limits in which its control function is no longer fulfilled.

Field observations carried out by BMW Motorrad indicate that a comparable situation has not arisen in traffic or even during training rides.

The following notes must be observed during safety training:

- check the warning and indicator lamps before any braking exercise
- ride the motorcycle over sufficient distance to charge the battery after a maximum of five braking exercises

- switch off consumers such as seat and grip heating, radio, navigation system and accessories connected to the power sockets
- in pauses and discussions, switch off the ignition; if the engine is switched off with the emergency off switch, the lights and all electronic systems remain switched on and drain the battery

How can I achieve the shortest braking distance?

Dynamic load distribution between the front and rear wheels changes under braking. The heavier the brakes are applied, the more load is transferred to the front brake. The greater the load on the wheel, the more braking force can be transferred.

To achieve the shortest braking distance, it is necessary to apply the front brake gradually and with increasing force. This makes best use of the dynamic increase in load on the front wheel. At the same time, the clutch should be disengaged.

In emergency braking as it is often taught, in which the brake pressure is generated as quickly as possible and with all possible force, the dynamic load distribution cannot follow the increasing deceleration and the braking force cannot be completely transferred to the road. The ABS has to intervene to ensure that the front wheel does not lock up; this reduces the brake pressure and the braking distance is extended.

What happens if ABS control fails?

A fault in BMW Motorrad Integral ABS is indicated by a corresponding warning display in the instrument cluster. If only ABS control fails, the Integral system and the brake servo action remain operational. If these systems also fail, the residual brake function is applied. In this case, the forces to be applied to the brake levers will be significantly higher and the lever travel required will be longer. The residual brake function is a mechanical function and is always available in the event of the failure of the BMW Motorrad Integral ABS, whatever the battery condition. It meets all requirements of legislation around the world

on the design of brakes for motor vehicles and allows the rider to brake the motorcycle. The following notes must be observed for riding with the residual braking function:

- set the brake lever to maximum travel
- always brake with both front and rear brakes
- where it is safe to do so, try out the brakes so that you can learn the brakes' response characteristics
- be aware of the prevailing road conditions and adapt your braking force accordingly
- since this is an emergency-run function, you should visit a specialist workshop, or better still a BMW Motorrad dealer, as quickly as possible



What is the role of regular maintenance?



Any technical system is only ever as good as its maintenance.

The service intervals specified must be kept to without fail to ensure that the BMW Motorrad Integral ABS is in an optimum maintenance condition. ◀

What is the design specification for BMW Motorrad Integral ABS?

BMW Motorrad Integral ABS ensures stability of the motorcycle on any surface within the bounds of physics.

The system is not designed for special requirements such as those that arise under extreme conditions of competition off-road or on the racetrack.

BMW Motorrad

Order No:
01 41 7 699 271
07.2005
1st edition GB/RF



The Ultimate
Riding Machine