

# Rider's Manual

## K 1300 GT



BMW Motorrad



The Ultimate  
Riding Machine

## Motorcycle data/dealership details

### Motorcycle data

---

Model

---

Vehicle identification number

---

Colour code

---

Date of first registration

---

Registration number

### Dealership details

---

Person to contact in Service department

---

Ms/Mr

---

Phone number

---

Dealership address/phone number (company stamp)

## **Welcome to BMW**

We congratulate you on your choice of a motorcycle from BMW and welcome you to the community of BMW riders.

Familiarise yourself with your new motorcycle so that you can ride it safely and confidently in all traffic situations.

Please read this Rider's Manual carefully before starting to use your new BMW motorcycle. It contains important information on how to operate the controls and how to make the best possible use of all your BMW's technical features.

In addition, it contains information on maintenance and care to help you maintain your motorcycle's reliability and safety, as well as its value.

If you have questions concerning your motorcycle, your authorised

BMW Motorrad dealer will gladly provide advice and assistance.

We hope that you will enjoy riding your BMW and that all your journeys will be pleasant and safe.

BMW Motorrad.

# Table of Contents

You can also consult the index at the end of this Rider's Manual if you want to find a particular topic or item of information.

## **1 General instructions .... 5**

Overview ..... 6

Abbreviations and symbols ..... 6

Equipment ..... 7

Technical data ..... 7

Currency ..... 7

## **2 General views ..... 9**

General view, left side ..... 11

General view, right side ..... 13

Handlebar fitting, left ..... 14

Handlebar fitting, right ..... 16

Underneath the seat ..... 19

Instrument cluster ..... 20

Headlight ..... 22

## **3 Status indicators ..... 23**

Standard status indicators ..... 24

Status indicators with on-board computer ..... 25

Status indicators with tyre-pressure monitoring (RDC) ..... 26

Status indicators with grip heating ..... 26

Status indicators with seat heating ..... 27

Telltale light with cruise control ..... 27

Standard warnings ..... 27

Warnings issued by the on-board computer ..... 34

ABS warnings ..... 36

ASC warnings ..... 38

RDC warnings ..... 40

Anti-theft alarm warnings.... 45

## **4 Operation..... 49**

Ignition switch and steering lock ..... 51

Electronic immobiliser (EWS) ..... 52

Clock..... 53

Odometer and tripmeters ..... 53

Multifunction display ..... 55

On-board computer ..... 55

Tyre pressure monitoring

RDC..... 59

Lights ..... 59

Turn indicators ..... 61

Hazard warning flashers ..... 61

Emergency off switch (kill switch) ..... 62

Grip heating ..... 62

Seat heating ..... 63

Automatic Stability Control ASC..... 65

Cruise-control system ..... 66

Seat height..... 69

Windscreen ..... 69

Clutch .....	69	<b>6 Engineering details..... 93</b>	Rims .....	118
Brakes .....	70	Brake system with BMW	Wheels .....	118
Handlebars .....	71	Motorrad Integral ABS .....	Front-wheel stand.....	127
Mirrors .....	71	Electronic engine manage-	Bulbs.....	128
Spring preload .....	71	ment with BMW Motorrad	Jump starting .....	134
Damping .....	72	ASC.....	Battery .....	135
Electronic Suspension Ad-		Tyre pressure monitoring		
justment ESA .....	73	RDC.....	<b>9 Care..... 139</b>	
Tyres.....	75	Electronic Suspension Ad-	Care products.....	140
Headlight.....	75	justment ESA II .....	Washing motorcycle.....	140
Stowage compartment .....	77	<b>7 Accessories .....</b>	Cleaning easily damaged	
Front and rear seats.....	77	<b>101</b>	components.....	140
Helmet holder .....	79	General instructions .....	Paint care .....	141
<b>5 Riding..... 81</b>		Power socket .....	Protective wax coating ...	142
Safety instructions .....	82	Luggage .....	Laying up motorcycle .....	142
Checklist .....	84	Case .....	Restoring motorcycle to	
Starting.....	84	Topcase.....	use.....	142
Running in .....	87	<b>8 Maintenance .....</b>	<b>10 Technical data .....</b>	<b>143</b>
Brakes .....	87	<b>109</b>	Troubleshooting chart.....	144
Parking your motorcycle ....	89	General instructions .....	Threaded fasteners .....	145
Refuelling .....	90	Toolkit.....	Engine .....	147
Securing motorcycle for		Engine oil .....	Fuel .....	148
transportation .....	92	Brake system .....	Engine oil .....	148
		Brake pads .....	Clutch.....	149
		Brake fluid.....	Transmission.....	149
		Clutch.....	Rear-wheel drive .....	150
		Tyres.....		

Running gear .....	150
Brakes .....	152
Wheels and tyres.....	152
Electrics.....	153
Frame .....	154
Dimensions .....	155
Weights .....	155
Riding specifications .....	156
<b>11 Service .....</b>	<b>157</b>
BMW Motorrad service....	158
BMW Motorrad service quality .....	158
BMW Motorrad Service Card: on-the-spot break- down assistance .....	158
BMW Motorrad service network .....	159
Maintenance work.....	159
Confirmation of mainten- ance work .....	160
Confirmation of service....	165

## General instructions

Overview .....	6
Abbreviations and symbols .....	6
Equipment .....	7
Technical data .....	7
Currency .....	7

## Overview

Chapter 2 of this Rider's Manual will provide you with an initial overview of your motorcycle. All maintenance and repair work on the motorcycle is documented in Chapter 11. This record of the maintenance work you have had performed on your motorcycle is a precondition for generous treatment of goodwill claims.

When the time comes to sell your BMW, please remember to hand over this Rider's Manual; it is an important part of the motorcycle.

## Abbreviations and symbols



Indicates warnings that you must comply with for reasons of your safety and the safety of others, and to protect your motorcycle against damage.



Specific instructions on how to operate, control, adjust or look after items of equipment on the motorcycle.



Indicates the end of an item of information.



Instruction.



Result of an activity.



Reference to a page with more detailed information.



Indicates the end of a passage relating to specific accessories or items of equipment.



Tightening torque.



Item of technical data.

OE

Optional extra  
The motorcycles are assembled complete with all the BMW optional extras originally ordered.

OA

Optional accessory  
You can obtain optional accessories through your authorised BMW Motorrad dealer; optional accessories have to be retrofitted to the motorcycle.

EWS

Electronic immobiliser (Elektronische Wegfahrsicherung).

DWA

Anti-theft alarm (Diebstahlwarnanlage)

ABS

Anti-lock brake system

ASC

Automatic Stability Control.

ESA Electronic Suspension Adjustment  
Electronic Suspension Adjustment.

RDC Tyre pressure control (Reifendruck-Control)

## Equipment

When you ordered your BMW motorcycle, you chose various items of custom equipment. This Rider's Manual describes optional extras (OE) offered by BMW and selected optional accessories (OA). This explains why the manual may also contain descriptions of equipment which you have not ordered. Please note, too, that your motorcycle might not be exactly as illustrated in this manual on account of country-specific differences. If your BMW was supplied with equipment not described in this Rider's Manual, you will

find these features described in separate manuals.

## Technical data

All dimensions, weights and power ratings stated in the Rider's Manual are quoted to the standards and comply with the tolerance requirements of the Deutsche Institut für Normung e.V. Versions for individual countries may differ.

## Currency

The high safety and quality standards of BMW motorcycles are maintained by constant development work on designs, equipment and accessories. Because of this, your motorcycle may differ from the information supplied in the Rider's Manual. Nor can BMW Motorrad entirely rule out errors and omissions. We hope you will appreciate that no claims can be entertained on

the basis of the data, illustrations or descriptions in this manual.



## General views

General view, left side.....	11
General view, right side .....	13
Handlebar fitting, left .....	14
Handlebar fitting, right .....	16
Underneath the seat .....	19
Instrument cluster .....	20
Headlight .....	22

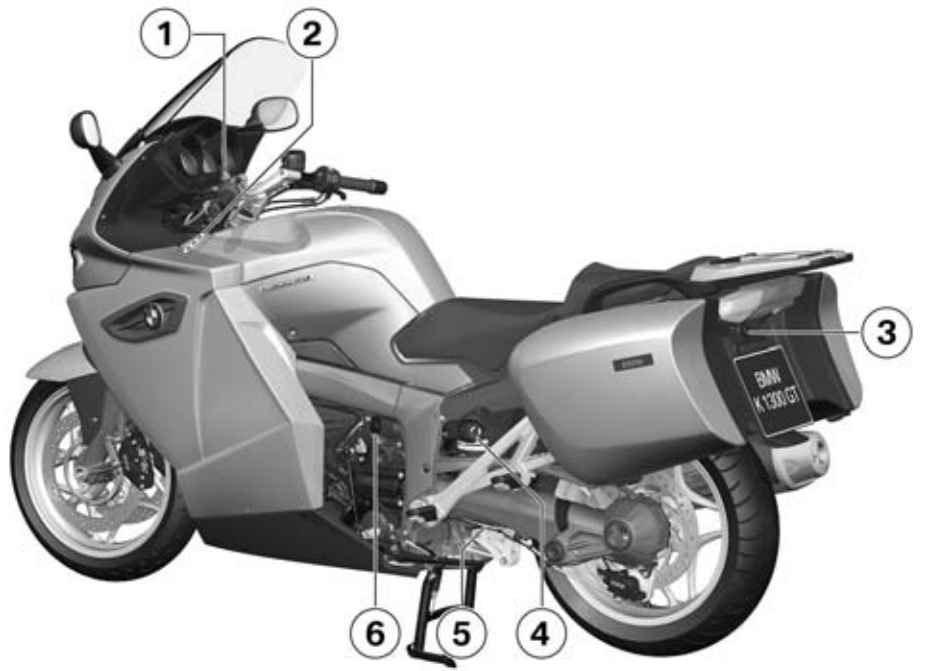

## General view, left side

- 1** Clutch-fluid reservoir  
(⇒ 117)
- 2** Adjuster for headlight  
beam throw (underneath  
the instrument cluster)  
(⇒ 76)
- 3** Seat lock (underneath the  
rear light) (⇒ 77)
- 4** Adjuster for spring preload,  
rear (⇒ 71)
- 5** Adjuster for damping char-  
acteristic, rear suspension  
(⇒ 72)
- 6** Power socket (⇒ 102)



## General view, right side

- 1 Fuel filler neck (⇒ 90)
- 2 Battery compartment (⇒ 137)
- 3 Brake-fluid reservoir, front (⇒ 113)
- 4 Storage compartment (⇒ 77)
- 5 Vehicle identification number (on side panel, front right)
- 6 Type plate (on lower rear cross-tube)

## Handlebar fitting, left

- 1 High-beam headlight and headlight flasher (⇒ 60)
- 2 – with cruise control system<sup>OE</sup>
- Cruise control system control (⇒ 66)
- 3 Hazard warning flashers (⇒ 61)
- 4 Windscreen control (⇒ 69)
- 5 Operation of the flashing turn indicators (⇒ 61)
- 6 Horn
- 7 – with Electronic Suspension Adjustment (ESA II)<sup>OE</sup>
- Operating ESA (⇒ 73)
- 8 – with Automatic Stability Control<sup>OE</sup>
- Operating ASC (⇒ 65)

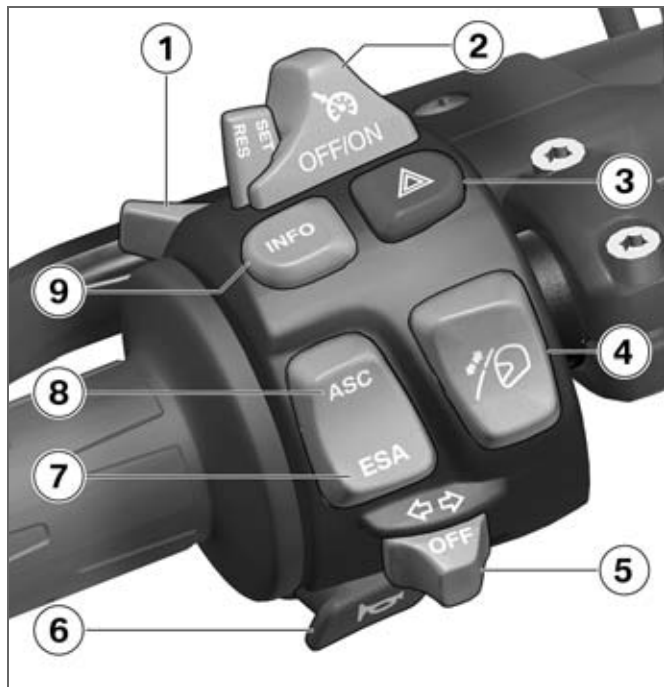

- 9** Operating the odometer  
(➡ 53)  
– with on-board computer<sup>OE</sup>  
Operating the on-board  
computer (➡ 55)

## Handlebar fitting, right

- 1 – with heated handlebar grips<sup>OE</sup>  
Grip heating control (⇒ 62)
- 2 – with seat heating<sup>OE</sup>  
Front seat heating control (⇒ 63)
- 3 Emergency off switch (kill switch) (⇒ 62)
- 4 Starter button (⇒ 84)





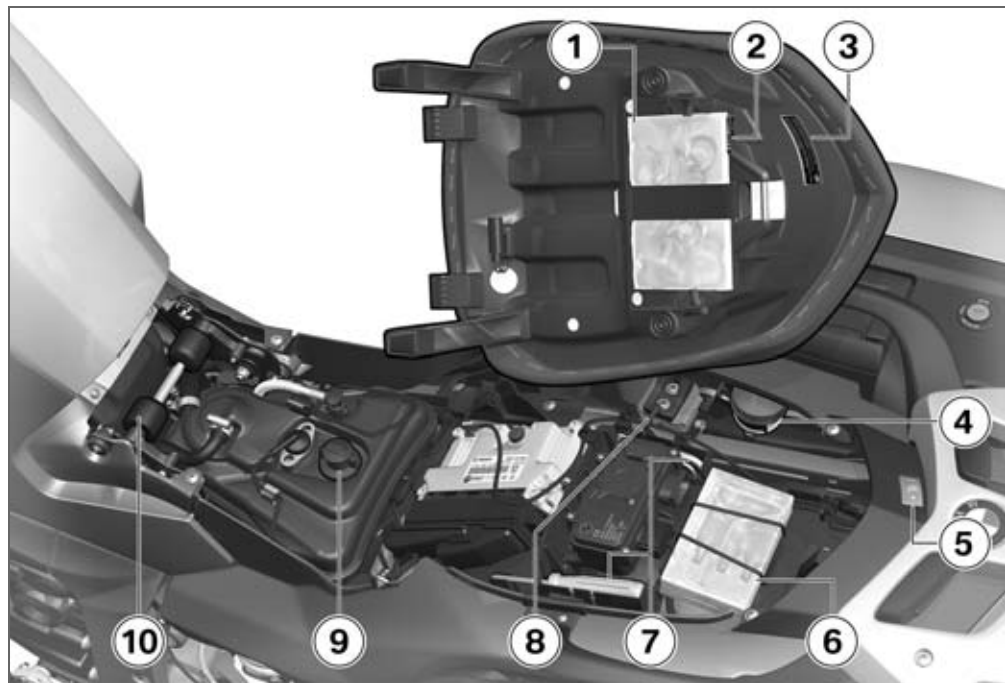

## Underneath the seat

- 1 Rider's Manual
- 2 Payload table (at the bottom of the rider's manual)
- 3 Table of tyre pressures
- 4 Brake-fluid reservoir, rear  
(⇒ 116)
- 5 – with seat heating<sup>OE</sup>  
Rear seat heating control  
(⇒ 64)
- 6 Storage for puncture repair kit (OA)
- 7 Toolkit (⇒ 110)
- 8 Helmet holder (⇒ 79).
- 9 Engine-oil filler neck  
(⇒ 112)  
Oil dipstick (⇒ 111)
- 10 Front-seat height adjustment (⇒ 69)

## Instrument cluster

- 1 Speedometer
- 2 Telltale lights (⇒ 24)
- 3 Rev. counter
- 4 Anti-theft alarm telltale light (OE, see the instructions for use of the anti-theft alarm)
- 5 Operation of the clock (⇒ 53)  
Adjust the dimmer (⇒ 55)
- 6 Multifunction display (⇒ 24)
- 7 Operating the odometer (⇒ 53)
- 8 Ambient-light brightness sensor (for adapting the brightness of the instrument lighting)
- 9 – with cruise control system<sup>OE</sup>  
Telltale light of cruise control (⇒ 66)

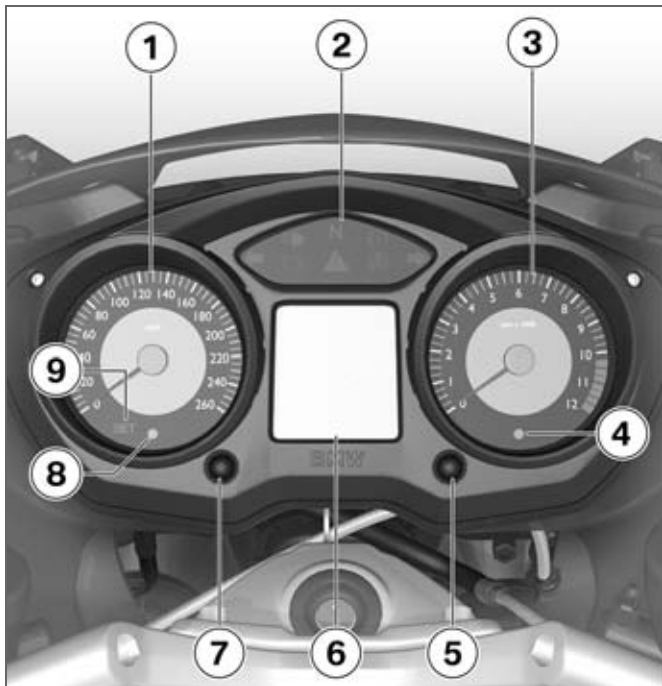

▶ The instrument-cluster lighting has automatic day and night switchover.◀

## Headlight

- 1 Side light
- 2 Low-beam headlight
- 3 High-beam headlight

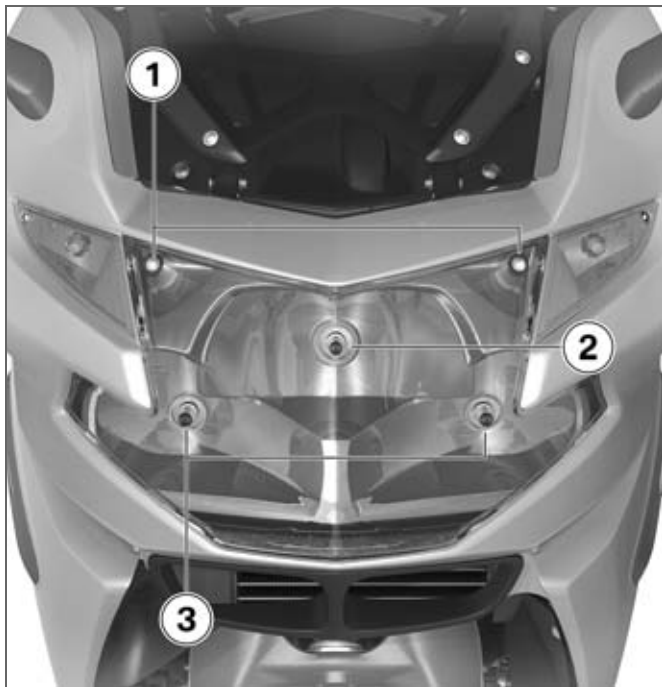

## Status indicators

Standard status indicators .....	24	Anti-theft alarm warnings .....	45
Status indicators with on-board computer .....	25		
Status indicators with tyre-pressure monitoring (RDC) .....	26		
Status indicators with grip heating .....	26		
Status indicators with seat heating .....	27		
Telltale light with cruise control .....	27		
Standard warnings .....	27		
Warnings issued by the on-board computer .....	34		
ABS warnings .....	36		
ASC warnings .....	38		
RDC warnings .....	40		

## Standard status indicators

### Multifunction display



- 1 Fuel capacity (⇒ 24)
- 2 Gear indicator (⇒ 24)
- 3 Coolant temperature (⇒ 24)
- 4 Clock (⇒ 53)
- 5 Odometer
- 6 Trip meter (⇒ 53)

## Telltale lights





- 1 Flashing turn indicators, left
- 2 High-beam headlight
- 3 Idle
- 4 Flashing turn indicators, right

## Fuel capacity

 The column below the fuel-pump symbol indicates the remaining quantity of fuel. When the fuel in the tank is topped up the gauge briefly shows the original level, before the reading is updated.

## Gear indicator

 The gear engaged or N for neutral appears on the display.

 If no gear is engaged, the 'neutral' telltale light also lights up.

## Coolant temperature

 The column below the temperature symbol indicates the coolant temperature.

## Service-due indicator



If the next service is due in less than one month, the date for the

next service is shown briefly after the Pre-Ride Check completes. The month and year are shown accompanied by the wording SERVICE. In this example, the display shows "March 2007".



If the motorcycle covers long distances in the course of the year, under certain circumstances it might be necessary to have it serviced at a date in advance of the forecast due date. If the countdown distance to the odometer reading at which a service will be due is less than 1000 km, the distance is counted down in

steps of 100 km and is shown briefly after the Pre-Ride Check completes.

If service is overdue, the date or the odometer reading is accompanied by the 'General' warning light showing yellow. The word "Service" remains permanently visible.

▶ If the service-due indicator appears more than a month before the service date, the date saved in the instrument cluster must be adjusted. This situation can occur if the battery was disconnected for a prolonged period of time.

If you want to have the date set consult a specialist workshop, preferably an authorised BMW Motorrad dealer. ◀

## Status indicators with on-board computer

– with on-board computer<sup>OE</sup>

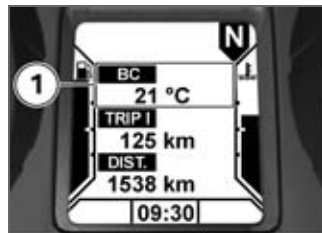

- 1 Status-indicator panel of the on-board computer (→ 55)

## Status indicators with tyre-pressure monitoring (RDC)

### Display option 1

- with tyre pressure monitoring (RDC)<sup>OE</sup>
- without on-board computer<sup>OE</sup>



- 1** – with tyre pressure monitoring (RDC)<sup>OE</sup>  
Tyre-pressure readout (→ 59)

▷ The figures shown in the tyre-pressure readings are temperature-compensated (see

the section entitled "Engineering details"). ◀

### Display option 2

- with tyre pressure monitoring (RDC)<sup>OE</sup>
- with on-board computer<sup>OE</sup>

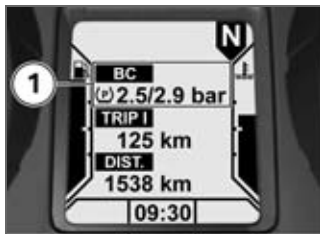

- 1** – with tyre pressure monitoring (RDC)<sup>OE</sup>  
Tyre-pressure readout (→ 59)

▷ The figures shown in the tyre-pressure readings are temperature-compensated (see

the section entitled "Engineering details"). ◀

## Status indicators with grip heating

- with heated handlebar grips<sup>OE</sup>

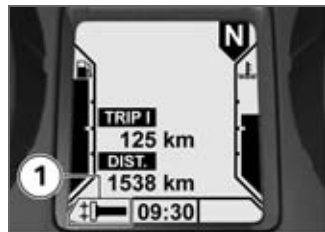

- 1** Display of the heating stages (→ 62)

## Status indicators with seat heating

– with seat heating<sup>OE</sup>



- 1 Display of the heating stages (⇒ 63)

## Telltale light with cruise control

– with cruise control system<sup>OE</sup>



- 1 Telltale light of cruise control

## Standard warnings Mode of presentation



Warnings are indicated by 'General' warning light **1** showing in combination with one of the warning symbols **2**. The 'General' warning light shows red or yellow, depending on the urgency of the warning. If two or more warnings occur at the same time, all the appropriate warning lights and warning symbols appear. The status of the 'General' warning light matches the most urgent warning.















The possible warnings are listed on the next page.

## Warnings, overview

### Telltale lights

### Status indicators

### Meaning

	Lights up yellow		EWS ! Appears on the display	Electronic immobiliser active (→ 31)
	Lights up yellow		Flashes	Fuel down to reserve (→ 31)
	Lights up red		Temperature reading flashes	Coolant temperature too high (→ 31)
	Lights up yellow		Appears on the display	Engine in emergency-operation mode (→ 32)
	Flashes red		Appears on the display	Insufficient engine oil pressure (→ 32)
	Lights up red		Appears on the display	Insufficient battery charge current (→ 33)
	Lights up yellow		Appears on the display	Rear light bulb defective (→ 33)
			Appears on the display	Front light bulb defective (→ 33)

**Telltale lights**

Lights up yellow

**Status indicators**

Appears on the display

**Meaning**

Bulbs defective (→ 34)

## Electronic immobiliser active

 General warning light shows yellow.

EWS ! appears on the display.

Possible cause:

The key being used is not authorised for starting, or communication between key and engine electronics is disrupted.

- Remove all other vehicle keys from the same ring as the ignition key.
- Use the reserve key.
- Have the defective key replaced, preferably by an authorised BMW Motorrad dealer.

## Fuel down to reserve

 General warning light shows yellow.

 Reserve fuel level symbol flashes

 Lack of fuel can result in the engine misfiring and cutting out unexpectedly. Misfiring can damage the catalytic converter; a hazardous situation can result if the engine cuts out unexpectedly.

Do not run the fuel tank dry.◀

Possible cause:

The fuel tank contains no more than the reserve quantity of fuel.

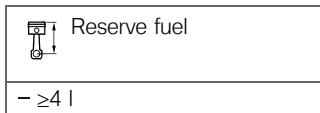



- ≥4 l

- Refuelling (→ 90).

## Coolant temperature too high

 General warning light shows red.

 The temperature reading flashes.

 Continuing to ride when the engine is overheated could result in engine damage. You must comply with the instructions below.◀

Possible cause:

The coolant temperature is too high.

- If possible, ride in the part-load range to cool down the engine.
- In traffic jams, switch off the engine, but leave the ignition switched on so that the radiator or fan continues to operate.
- If the coolant temperature is frequently too high, have the fault rectified as soon as possible by a specialist workshop, preferably an authorised BMW Motorrad dealer.

## Engine in emergency-operation mode



General warning light shows yellow.



Engine symbol appears on the display.



The engine is running in emergency operating mode.

Engine power might be reduced and this can cause hazardous situations, particularly if you attempt to overtake other road users.

Engine power level might be lower than normal: adapt your style of riding accordingly.◀

Possible cause:

The engine control unit has diagnosed a fault. In exceptional cases, the engine stops and refuses to start. Otherwise, the engine runs in emergency operating mode.

- You can continue to ride, but bear in mind that the usual engine power might not be available.
- Have the fault rectified as quickly as possible by a specialist workshop, preferably an authorised BMW Motorrad dealer.

## Insufficient engine oil pressure



General warning light flashes red.



Oil-can symbol appears on the display.

The oil pressure in the lube-oil system is too low. Stop immediately and switch off the engine if the warning light shows.



The insufficient oil pressure warning does not fulfil the function of an oil gauge. The only way of checking whether the

oil level is correct is to check the oil level indicator.◀

Possible cause:

The engine-oil level is too low.

- Checking engine oil level (⇒ 111).
- If the oil level is too low:
- Topping up engine oil (⇒ 112).

Possible cause:

The engine-oil pressure is insufficient.



Riding when engine-oil pressure is low can result in engine damage.

Do not continue your journey.◀

- Have the fault rectified as quickly as possible by a specialist workshop, preferably an authorised BMW Motorrad dealer.

## Insufficient battery charge current



General warning light shows red.



Battery symbol appears on the display.



A discharged battery can render various systems unavailable, for example the lights, the engine or the ABS. This can result in dangerous situations. If possible, do not continue your journey. ◀

Battery is not being charged. If you continue to ride the motorcycle the on-board electronics will drain the battery.

Possible cause:

Alternator or alternator drive belt defective

- Have the fault rectified as quickly as possible by a specialist workshop, preferably

an authorised BMW Motorrad dealer.

## Rear light bulb defective



General warning light shows yellow.



Bulb symbol with arrow pointing to the rear appears on the display.



A defective bulb places your safety at risk because it is easier for other users to

oversee the motorcycle. Replace defective bulbs as soon as possible; always carry a complete set of spare bulbs if possible. ◀

Possible cause:

Rear light or brake light bulb defective.

- Replacing brake-light, rear-light and rear-indicator bulbs (⇒ 133).

## Front light bulb defective



Bulb symbol with arrow pointing to the front appears on the display.



A defective bulb places your safety at risk because it is easier for other users to

oversee the motorcycle. Replace defective bulbs as soon as possible; always carry a complete set of spare bulbs if possible. ◀

Possible cause:

Low-beam headlight, high-beam headlight, side light or turn indicator bulb defective.

- Replacing low-beam and high-beam headlight bulb (⇒ 129).
- Replacing parking-light bulb (⇒ 130).
- Replacing front turn indicator bulbs (⇒ 131).
- Replacing brake-light, rear-light and rear-indicator bulbs (⇒ 133).

## Bulbs defective

 General warning light shows yellow.

 Bulb symbol with two arrows appears on the display.

 A defective bulb places your safety at risk because it is easier for other users to oversee the motorcycle. Replace defective bulbs as soon as possible; always carry a complete set of spare bulbs if possible. ◀

Possible cause:

A combination of the bulb defects described above has occurred.

- See the fault descriptions above.

## Warnings issued by the on-board computer

### Mode of presentation

– with on-board computer<sup>OE</sup>





Warnings issued by the on-board computer appear in panel **1**. The possible warnings are listed on the next page.

## Warnings, overview

### Telltale lights

### Status indicators

### Meaning

	Oil ! Appears on the display	Engine-oil level too low (→ 36)
	Appears on the display	
	Ambient-temperature reading flashes.	Ice warning (→ 36)
	Flashes	

## Engine-oil level too low

**Oil !** appears on the display.



Oil-level symbol appears on the display.

Possible cause:

The electronic oil-level sensor has registered an excessively low oil level. Check the engine-oil level at the oil-level indicator the next time you stop to refuel:

- Checking engine oil level (➔ 111).

If the oil level is too low:

- Topping up engine oil (➔ 112).

Possible cause:

The oil sensor might be defective if the "Check oil level" message appears even though a check of the oil sight glass shows that the oil level is correct.

- Seek the advice of a specialist workshop, preferably an authorised BMW Motorrad dealer.

## Ice warning

The ambient-temperature reading flashes.



Ice-crystal symbol flashes.

Possible cause:

The air temperature measured at the motorcycle is lower than 3 °C.



The ice warning does not mean that there is no risk of black ice forming at measured temperatures above 3 °C. Always take extra care and think well ahead when temperatures are low; remember that the danger of black ice is particularly high on bridges and where the road is in the shade.◀

- Ride carefully and think well ahead.

## ABS warnings

### Mode of presentation



ABS warnings are indicated by ABS warning light **1**.

The way in which the ABS warning light indicates status can differ in some countries.



Possible national variant.

The detailed descriptions relating to BMW Motorrad Integral ABS start on page (➔ 94), and you will find an overview listing the possible warnings on the next page.

## Warnings, overview

### Telltale lights

### Status indicators

### Meaning

---

	Flashes	ABS self-diagnosis not completed (➡ 38)
	Lights up	ABS fault (➡ 38)

---

## ABS self-diagnosis not completed



ABS warning light flashes.

Possible cause:

The ABS function is not available, because self-diagnosis did not complete. The motorcycle has to move forward a few metres for the wheel sensors to be tested.

- Pull away slowly. Bear in mind that the ABS function is not available until self-diagnosis has completed.

## ABS fault



ABS warning light shows.

Possible cause:

The ABS control unit has detected a fault. The ABS function is not available.

- You can continue to ride the motorcycle, but make due provision for the fact that the ABS function is not available. Bear in mind the more detailed information on situations that can lead to an ABS fault (→ 95).
- Have the fault rectified as quickly as possible by a specialist workshop, preferably an authorised BMW Motorrad dealer.

## ASC warnings

### Mode of presentation

- with Automatic Stability Control<sup>OE</sup>



ASC warnings are indicated by ASC warning light **1**.

The detailed descriptions relating to BMW Motorrad ASC start on page (→ 96), and you will find an overview listing the possible warnings on the next page.

## Warnings, overview

### Telltale lights

### Status indicators

### Meaning



Quick-flashes

ASC intervention (→ 40)



Slow-flashes

Self-diagnosis not completed (→ 40)



Lights up

ASC deactivated (→ 40)



Lights up

ASC fault (→ 40)

## ASC intervention



ASC warning light quick-flashes.

The ASC has detected a degree of instability at the rear wheel and has intervened to reduce torque. The warning light flashes for longer than ASC intervention lasts. This affords the rider visual feedback on control intervention even after the critical situation has been dealt with.

## Self-diagnosis not completed



ASC warning light slow-flashes.

Possible cause:

Self-diagnosis did not complete, so the ASC function is not available. The engine must be running and the motorcycle must reach a speed of at least 5 km/h in order for ASC self-diagnosis to complete.

- Pull away slowly. Bear in mind that the ASC function is not available until self-diagnosis has completed.

## ASC deactivated



ASC warning light shows.

Possible cause:

The rider has switched off the ASC system.

- with Automatic Stability Control<sup>OE</sup>
- Activating ASC function (→ 66).

## ASC fault



ASC warning light shows.

Possible cause:

The ASC control unit has detected a fault. The ASC function is not available.

- You can continue to ride. Bear in mind that the ASC function

is not available. Bear in mind the more detailed information on situations that can lead to an ASC fault (→ 97).

- Have the fault rectified as quickly as possible by a specialist workshop, preferably an authorised BMW Motorrad dealer.

## RDC warnings

### Mode of presentation

- with tyre pressure monitoring (RDC)<sup>OE</sup>



Warning symbol **2** indicates a critical tyre pressure; the corresponding reading flashes. If the critical value is close to the limit of the permissible tolerance range, 'General' warning light **1** shows yellow. If the tyre pressure registered by the sensor is outside the permissible tolerance range, the 'General' warning light **1** flashes red.



The critical tyre press of the front wheel **3** or as applicable the rear wheel **4** flashes.

– with on-board computer<sup>OE</sup>



The critical tyre press of the front wheel **3** or as applicable the rear wheel **4** flashes.◀









The detailed descriptions relating to BMW Motorrad RDC start on page (→ 98), and you will find an overview listing the possible warnings on the next page.

## Warnings, overview

### Telltale lights

### Status indicators

### Meaning

	Lights up yellow		Appears on the display	Tyre pressure close to limit of permitted tolerance (⇒ 43)
			The critical tyre pressure flashes.	
	Flashes red		Appears on the display	Tyre pressure outside permitted tolerance (⇒ 43)
			The critical tyre pressure flashes.	
			"--" or "-- --" is displayed.	Signal transmission disrupted (⇒ 43)
	Lights up yellow		Appears on the display	Sensor defective or system error (⇒ 44)
			"--" or "-- --" is displayed.	
	Lights up yellow		RDC Appears on the display	Battery of tyre-pressure sensor weak (⇒ 45)
			Appears on the display	

## Tyre pressure close to limit of permitted tolerance



General warning light shows yellow.



Tyre symbol appears on the display.

The critical tyre pressure flashes.  
Possible cause:

Measured tyre pressure is close to the limit of permitted tolerance.

- Correct the tyre pressure as stated on the inside cover of the Rider's Manual.



Before you adjust tyre pressure, read the information on temperature compensation and adjusting pressure in the section entitled "Engineering details".◀

## Tyre pressure outside permitted tolerance



General warning light flashes red.



Tyre symbol appears on the display.

The critical tyre pressure flashes.  
Possible cause:

Measured tyre pressure is outside permitted tolerance.

- Check the tyre for damage and to ascertain whether the motorcycle can be ridden with the tyre in its present condition.

If the motorcycle can be ridden with the tyre in its present condition:



Incorrect tyre pressures impair the motorcycle's handling characteristics.

If tyre pressure is incorrect it is essential to adapt your style of riding accordingly.◀

- Correct the tyre pressure at the earliest possible opportunity.



Before you adjust tyre pressure, read the information on temperature compensation and adjusting pressure in the section entitled "Engineering details".◀

- Have the tyre checked for damage by a specialist workshop, preferably an authorised BMW Motorrad dealer.

If you are unsure whether the motorcycle can be ridden with the tyre in its present condition:

- Do not continue your journey.
- Notify the breakdown service.

## Signal transmission disrupted

"--" or "-- --" is displayed.

Possible cause:

The motorcycle has not yet accelerated past the threshold of approximately 30 km/h. The RDC sensors do not start transmitting signals until the motorcycle reaches a speed above this threshold for the first time (➔ 98).

- Increase speed above this threshold and observe the RDC readings. Assume that a permanent fault has not occurred unless the 'General' warning light comes on to accompany the symptoms. Under these circumstances:
- Have the fault rectified by a specialist workshop, preferably an authorised BMW Motorrad dealer.

Possible cause:

Wireless communication with the RDC sensors has been disrupted. Possible causes include radio-communication systems operating in the vicinity and interfering with the link between the RDC control unit and the sensors.

- Move to another location and observe the RDC readings. Assume that a permanent fault has not occurred unless the 'General' warning light comes on to accompany the symptoms. Under these circumstances:
- Have the fault rectified by a specialist workshop, preferably an authorised BMW Motorrad dealer.

### Sensor defective or system error



General warning light shows yellow.



Tyre symbol appears on the display.

"\_ \_" or "\_ \_ \_ \_" is displayed.

Possible cause:

Motorcycle is fitted with wheels not equipped with RDC sensors.

- Fit wheels and tyres equipped with RDC sensors.

Possible cause:

One or two RDC sensors have failed.

- Have the fault rectified by a specialist workshop, preferably an authorised BMW Motorrad dealer.

Possible cause:

A system error has occurred.

- Have the fault rectified by a specialist workshop, preferably an authorised BMW Motorrad dealer.

## Battery of tyre-pressure sensor weak

 General warning light shows yellow.

RDC appears on the display.

 Battery symbol appears on the display.

 This error message appears only briefly after the pre-ride check completes. ◀

Possible cause:

The integral battery in the tyre-pressure sensor has lost a significant proportion of its original capacity. There is no assurance of how long the tyre pressure control system can remain operational.

- Seek the advice of a specialist workshop, preferably an authorised BMW Motorrad dealer.

## Anti-theft alarm warnings

### Mode of presentation

– with anti-theft alarm (DWA)<sup>OE</sup>





Anti-theft alarm warnings appear in panel **2** in combination with the 'General' warning light **1** showing after the Pre-Ride Check and relate to the capacity of the internal battery that supplies power to the anti-theft alarm.

The possible warnings are listed on the next page.

**Warnings, overview****Telltale lights****Status indicators****Meaning**

---

	 Appears on the display	Anti-theft alarm battery weak (➔ 47)
 Lights up yellow	 Appears on the display	Anti-theft alarm battery flat (➔ 47)

---

## Anti-theft alarm battery weak

DWA appears on the display.



Battery symbol appears on the display.

 This error message appears only briefly after the pre-ride check completes.◀

Possible cause:

The integral battery in the anti-theft alarm has lost a significant proportion of its original capacity. There is no assurance of how long the anti-theft alarm can remain operational if the motorcycle's battery is disconnected.

- Seek the advice of a specialist workshop, preferably an authorised BMW Motorrad dealer.

## Anti-theft alarm battery flat



General warning light shows yellow.



Battery symbol appears on the display.

DWA appears on the display.

 This error message appears only briefly after the pre-ride check completes.◀

Possible cause:

The integral battery in the anti-theft alarm has lost its entire original capacity. There is no assurance that the anti-theft alarm will be operational if the motorcycle's battery is disconnected.

- Seek the advice of a specialist workshop, preferably an authorised BMW Motorrad dealer.



## Operation

Ignition switch and steering lock ....	51	Cruise-control system .....	66
Electronic immobiliser (EWS) .....	52	Seat height .....	69
Clock .....	53	Windscreen .....	69
Odometer and tripmeters .....	53	Clutch .....	69
Multifunction display .....	55	Brakes .....	70
On-board computer .....	55	Handlebars .....	71
Tyre pressure monitoring RDC ....	59	Mirrors .....	71
Lights .....	59	Spring preload .....	71
Turn indicators .....	61	Damping .....	72
Hazard warning flashers .....	61	Electronic Suspension Adjustment ESA .....	73
Emergency off switch (kill switch) .....	62	Tyres .....	75
Grip heating .....	62	Headlight .....	75
Seat heating .....	63	Stowage compartment .....	77
Automatic Stability Control ASC ....	65	Front and rear seats .....	77

Helmet holder ..... 79

## Ignition switch and steering lock

### Keys

You receive two master keys and one spare key. Please consult the information on the electronic immobiliser (EWS) if a key is lost or mislaid (⇒ 52).

Ignition switch and steering lock, tank filler cap lock and the seat and case locks are all operated with the same key.

– with large topcase<sup>OA</sup>

or

– with small topcase<sup>OA</sup>

If you wish you can arrange to have the topcase fitted with a lock that can be opened with this key as well. Consult a specialist workshop, preferably an authorised BMW Motorrad dealer.◁

### Switching on ignition



- Turn the key to position **1**.
  - » Side light and all function circuits switched on.
  - » Engine can be started.
  - » Pre-ride check is performed. (⇒ 85)
  - » ABS self-diagnosis is performed. (⇒ 85)
- with Automatic Stability Control<sup>OE</sup>
  - » ASC self-diagnosis is performed. (⇒ 86)

### Switching off ignition



- Turn the key to position **2**.
  - » Lights switched off.
  - » Handlebars not locked.
  - » Key can be removed.
  - » Electrically powered accessories remain operational for a limited period of time.
  - » The battery can be recharged via the on-board socket.

## Lock the handlebars

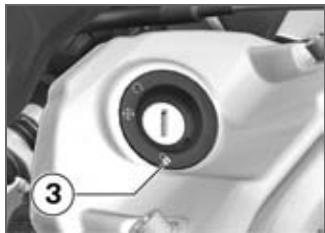

**!** If the motorcycle is on the side stand, the surface of the ground will determine whether it is better to turn the handlebars to the left or right. However, the motorcycle is more stable on a level surface with the handlebars turned to the left than with the handlebars turned to the right.

On level ground, always turn the handlebars to the left to set the steering lock. ◀

- Turn the handlebars to the full left or right lock position.

- Turn the key to position **3**, while moving the handlebars slightly.
- » Ignition, lights and all function circuits switched off.
- » Handlebars locked.
- » Key can be removed.

## Electronic immobiliser (EWS)

### Protection against theft

The electronic immobiliser helps protect your BMW motorcycle from theft, and this enhanced security is at your disposal without any need for you to set parameters or activate additional systems. The engine of a motorcycle fitted with this electronic immobiliser can be started only with the keys that belong to the vehicle. You can also have your authorised BMW Motorrad dealer bar individual keys, for example if a particular key goes missing. The

engine cannot be started with a key that has been barred.

## In-key electronics

The motorcycle's electronics exchange certain continuously changing signals with the electronics in the key; these signals are specific to your motorcycle and they are transmitted via the ring aerial in the ignition lock. The ignition is not enabled for starting until the key has been recognised as "authorised" for your motorcycle.

▶ A spare key attached to the same ring as the ignition key used to start the engine could "irritate" the electronics, in which case the enabling signal for starting is not issued. The EWS warning appears in the multifunction display. Always keep the spare key separately from the ignition key. ◀

## Replacement and extra keys

You can obtain replacement/extra keys only through an authorised BMW Motorrad dealer. The keys are part of an integrated security system, so the dealer is under an obligation to check the legitimacy of all applications for replacement/extra keys. If you want to have a lost key barred, you have to bring with you all the other keys that belong to the motorcycle. A key that has been barred can subsequently be cleared and reactivated for use.

## Clock

### Setting clock

 Attempting to set the clock while riding the motorcycle can lead to accidents. Set the clock only when the motorcycle is stationary. ◀

- Switch on the ignition.



- Press and hold down button **1**.
  - » Hours reading **2** flashes.
- Press button **1**.
  - » The hours reading increments by one each time you press the button.
- Press and hold down button **1**.
  - » Minutes reading **3** flashes.
- Press button **1**.
  - » The minutes reading increments by one each time you press the button.

- Either press and hold down button **1** or wait without pressing a button.
  - » The clock is now set and the time appears on the display.

## Odometer and tripmeters

### Selecting odometer

- Switch on the ignition.



- Press button **1**.



The display starts with the current value and each time the button is pressed it moves one step through the following sequence:

- Tripmeter 1 (Trip I)
- Tripmeter 2 (Trip II)
- Residual range (once fuel level is down to reserve)
- with tyre pressure monitoring (RDC)<sup>OE</sup>

Tyre pressures

- without on-board computer<sup>OE</sup>



- Alternatively, press button **2**.<

### Resetting tripmeter

- Switch on the ignition.
- Select the desired tripmeter.



- Press and hold down button **1**.  
» The tripmeter is reset to zero.

- without on-board computer<sup>OE</sup>



- Alternatively, press button **2**.<

## Residual range

– without on-board computer<sup>OE</sup>



The residual-range readout **1** indicates how far you can ride with the fuel remaining in the tank. This reading is not displayed until fuel level has dropped to reserve. This distance is calculated on the basis of fuel level and average consumption.

When refuelling after running on reserve, make sure that you top up the tank to a level above reserve, as otherwise the sensor will not be able to register the new level. If the sensor cannot register the new level neither

the fuel-level reading nor the residual-range readout can be updated.

▶ The calculated range is an approximate value. Consequently, BMW Motorrad recommends that you should not try to use the full residual range before refuelling.◀◀

## Multifunction display

### Adjust the dimmer



⚠ Attempting to adjust the dimmer while riding the motorcycle can lead to accidents. Do not attempt to adjust the

dimmer unless the motorcycle is at a standstill.◀

- Press button **1**.
- » The level of dimming appears in display field **2**.
- Press button **1** again.
- » The brightness of the display increases one level each time you press the button. Each time you press the button after maximum brightness is reached, brightness is reduced by one level.

## On-board computer

– with on-board computer<sup>OE</sup>

### Selecting readings

- Switch on the ignition.



- Press button **1**.



The display starts with the current value and each time the button is pressed it moves one step through the following sequence:

- Ambient temperature

- Range
- Average speed
- Average consumption
- Oil level
- with tyre pressure monitoring (RDC)<sup>OE</sup>

Tyre pressures

### Ambient temperature



When the motorcycle is at a standstill the heat of the engine can falsify ambient-temperature reading **1**. If the effect of the engine's heat becomes excessive, -- temporarily appears on the display.

 If ambient temperature drops below 3 °C a warning appears, drawing your attention to the risk of black ice forming. The display automatically switches from any other mode to the temperature reading when the temperature drops below this threshold for the first time.

### Range



The description of the residual-range function (→ 55) also covers range readout **1**. You can also view the range before the fuel level drops to reserve.

A special average-consumption figure is used to calculate range; this figure is not necessarily the same as the value you can call up for viewing on the display. When the motorcycle is propped on its side stand the slight angle of inclination means that the sensor cannot register the fuel level correctly. This is the reason why the range is calculated only when the motorcycle is on the move.

▶ The calculated range is only an approximate reading. Consequently, BMW Motorrad recommends that you should not try to use the full range before refuelling.◀

## Average speed



Average speed **1** is calculated on the basis of the time elapsed since the last reset. Times during which the engine was stopped are excluded from the calculation.

## Resetting average speed

- Switch on the ignition.
- Select average speed.



- Press and hold down button **1**.  
» Average speed is reset to zero.

## Average consumption



Average consumption **1** is calculated by dividing the distance covered since the last reset by

the corresponding amount of fuel used.

## Reset the average consumption

- Switch on the ignition.
- Select average speed.



- Press and hold down button **1**.  
» Average consumption is reset to zero.

## Oil level

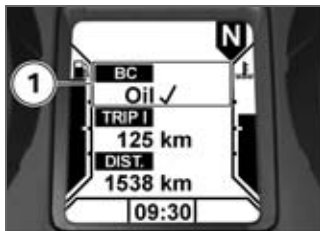

Oil-level indicator **1** gives you an indication of the engine oil level. You can call up this reading only when the motorcycle is at a standstill.

The preconditions for the oil level check are as follows:

- Engine at operating temperature.
- Engine idling for at least 10 seconds.
- Side stand retracted.
- Make sure the motorcycle is upright.

The readings mean:



Oil level is correct



Check the oil level with the dipstick the next time you stop for fuel. If you call up another reading on the on-board computer, this symbol remains visible until the sensor again registers a correct oil level.



Oil level cannot be measured (conditions as stated above not satisfied).

The most recently measured level is displayed for 5 seconds when you next switch on the ignition.



The oil-level sensor might be defective if the "Check oil level" message appears even though the oil level in the oil sight glass is correct. In this case, consult your authorised BMW Motorrad dealer. ◀

## Tyre pressure monitoring RDC

– with tyre pressure monitoring (RDC)<sup>OE</sup>

### Viewing tyre-pressure readings

- Switch on the ignition.



- Repeatedly press button **1**, until the tyre pressures are displayed in the odometer panel.



The tyre pressures are shown, accompanied by the wording RDC. The front tyre pressure is on the left; the reading on the right is the rear tyre pressure. The tyre-pressure readings are based on a reference tyre temperature of 20 °C. --- appears directly after the ignition is switched on, because the sensors do not transmit tyre pressures until the first time the motorcycle accelerates to more than 30 km/h.

 Indicates the reading for tyre pressures.

– with on-board computer<sup>OE</sup>



The tyre pressures are displayed as an additional set of readings by the on-board computer.

## Lights

### Side light

The side lights switch on automatically when the ignition is switched on.

 The side lights place a strain on the battery. Do not switch the ignition

on for longer than absolutely necessary. ◀

### Low-beam headlight

The low-beam headlight switches on automatically when you start the engine.

▶ When the engine is not running you can switch on the lights by switching on the ignition and either switching on the high-beam headlight or operating the headlight flasher. ◀

### High-beam headlight



- Press the high-beam headlight switch **1** forwards.
- » High-beam headlight switched on.
- Return the high-beam headlight switch **1** to its initial position.
- » High-beam headlight switched off.
- Pull the high-beam headlight switch **1** to the rear.
- » The high-beam headlight is switched on until you release the button (headlight flasher).

### Switching on parking lights

- Switch off the ignition.



- Immediately after switching off the ignition, press turn-indicator button **1** to the left and hold down.
- » Parking light switches on.

### Switching off parking lights

- Switch the ignition on and then off again.
- » Parking lights switched off.

## Turn indicators

### Operating turn indicators



- Push turn-indicator button **1** to the left.
  - » Left-hand turn indicators switched on.
  - » Telltale light for left-hand turn indicators flashes.
- Push the turn-indicator button to the right.
  - » Right-hand turn indicators switched on.
  - » Telltale light for right-hand turn indicator flashes.

- Centre the turn-indicator switch.
  - » Flashing turn indicators switched off.
  - » Turn indicator telltale light is off.

### Hazard warning flashers

#### Switch on the hazard warning flashers

- Switch on the ignition.
  - ▶ The hazard warning flashers place a strain on the battery. Do not use the hazard warning flashers for longer than absolutely necessary.◀



- Press button **1** for the hazard warning flashers.
  - ▶ If you press a turn-indicator or button with the ignition switched on, the turn-indicator function is activated instead of the hazard warning flashers, and remains active until you release the button. The hazard warning flashers recommence flashing as soon as the button is released.◀
    - » The hazard warning flashers are switched on.
    - » Left and right turn indicator telltale lights flash.
- Switch off the ignition.

- » The hazard warning flashers continue to operate.
- » Left and right turn indicator telltale lights are off.

## Switch off the hazard warning flashers



- Press button **1** for the hazard warning flashers.
- » Hazard warning flashers switched off.

## Emergency off switch (kill switch)



- 1** Emergency off switch (kill switch)

 Operating the kill switch when riding can cause the rear wheel to lock and thus cause a fall.  
Do not operate the kill switch when riding. ◀

The emergency off switch is a kill switch for switching off the engine quickly and easily.



- a** Engine switched off  
**b** Normal operating position (run)

## Grip heating

– with heated handlebar grips<sup>OE</sup>

### Operating grip heating

- Start the engine.

 Grip heating can be activated only when the engine is running. If the engine is switched off, grip heating must be reactivated once the engine is switched on again. ◀

▷ The increase in power consumption caused by the grip heating can drain the battery if you are riding at low engine speeds. If the charge level is low, grip heating is switched off to ensure the battery's starting capability.◀

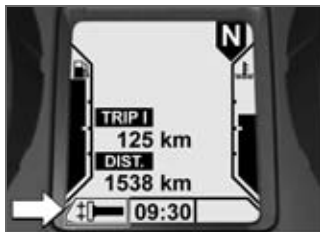

The handlebar grips have two-stage heating. Stage two is for heating the grips quickly: it is advisable to switch back to stage one as soon as the grips are warm. Grip heating can be activated only when the engine is running.

- Repeatedly press button **1** until the desired heating stage appears on the display.



50% heating power



100% heating power

» The selected heating stage will be saved if you allow a certain length of time to pass without making further changes.

## Seat heating

– with seat heating<sup>OE</sup>

### Front-seat heating



- Press button **1** to adjust the heating stage.



**1** Front seat heating switch

The front seat has two-stage heating. Stage two is for heating the seat quickly: it is advisable to switch back to stage one as soon as the seat is warm.

▶ Seat heating can be activated only when the engine is running. If the engine is switched off, seat heating must be reactivated once the engine is switched on again.◀

▶ The increase in power consumption caused by the seat heating can drain the battery if you are riding at low engine speeds. If the charge level is low, seat heating is switched off to ensure the battery's starting capability.◀

## Rear seat heating



1 Rear seat heating switch

The rear seat has two-stage heating. Stage two is for heating the seat quickly: it is advisable to switch back to stage one as soon as the seat is warm.

▶ Seat heating can be activated only when the engine is running. If the engine is switched off, seat heating must be reactivated once the engine is switched on again.◀

▶ The increase in power consumption caused by the seat heating can drain the battery if you are riding at low engine speeds. If the charge level is low, seat heating is switched off to ensure the battery's starting capability.◀

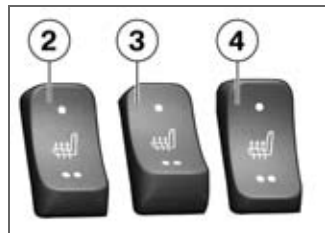

- 2 Switch centred: Heating off.
- 3 Switch at point one: 50% heating power.
- 4 Switch at point two: 100% heating power.

## Indicator in multifunction display



The symbols shown below appear on the display to indicate which heating stage has been selected:



Front seat, 50 % heating power



Front seat, 100 % heating power



Rear seat, 50 % heating power



Rear seat, 100 % heating power

## Automatic Stability Control ASC

– with Automatic Stability Control<sup>OE</sup>



### Deactivate the ASC function

- Switch on the ignition.



You have the option of deactivating the ASC function while the motorcycle is on the move. ◀



- Press and hold down ASC button **1**.
  -  ASC warning light starts to show.
  - Release the ASC button within two seconds.
  -  ASC warning light remains ON.
- » The ASC function is deactivated.

## Activating ASC function



- Press and hold down ASC button **1**.

 ASC warning light goes out; if self-diagnosis has not completed the ASC warning light starts flashing.

- Release the ASC button within two seconds.

 The ASC warning light remains off or continues to flash.

- » The ASC function is activated.
- Instead of pressing the ASC button, you have the option of

switching the ignition off and then on again.

 An ASC fault has occurred if the ASC warning light shows when the motorcycle accelerates to a speed in excess of 10 km/h after the ignition was switched off and then on again.◀

## Cruise-control system

– with cruise control system<sup>OE</sup>

### Switching on cruise control





- Slide switch **1** to the right.
- » Button **2** is operational.

## Setting road speed



- Briefly push button **2** towards the front.

 Cruise control can be used in the speed range from 50 km/h to 180 km/h.◀

 Telltale light for cruise control shows.

- » The motorcycle maintains your current cruising speed and the setting is saved.

## Step-by-step acceleration



- Briefly push button **2** towards the front.
- » Speed is increased by approx. 2 km/h each time you push the button, and the new setting is saved.

## Stepless acceleration



- Push and hold button **2** towards the front.
- » The motorcycle accelerates steplessly.
- Release button **2**.
- » The motorcycle maintains your current cruising speed and the setting is saved.

## Step-by-step deceleration



- Briefly push button **2** towards the back.
- » Speed is decreased by approx. 2 km/h each time you push the button, and the new setting is saved.

## Stepless deceleration



- Push and hold button **2** towards the back.
- » The motorcycle decelerates steplessly.
- Release button **2**.
- » The motorcycle maintains your current cruising speed and the setting is saved.

## Deactivate cruise control

- Apply the brakes or pull the clutch or close the throttle (turn the throttle twistgrip back past the idle position).

- » The cruise-control system is deactivated.
- » Telltale light for cruise-control goes out.

## Resuming former cruising speed



- Briefly push button **2** towards the back.

▷ Opening the throttle does not deactivate the cruise-control system. If you release the twistgrip the motorcycle will decelerate only to the cruising speed saved in memory, even

though you might have intended slowing to a lower speed. ◀

**SET** Telltale light for cruise control shows.

- » The motorcycle resumes the previous cruising speed.

## Switch off cruise control



- Slide switch **1** to the left.
- » The system is deactivated.
- » Button **2** is disabled.

## Seat height

### Adjusting seat height

- Remove the front seat (→ 78).



- Pull seat-height adjuster **1** to the limit position.

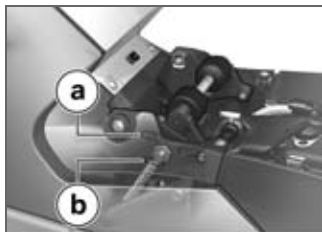

- Push the seat height adjuster fully forward and up or down, as applicable.
  - » Limit position **a**: high seat position.
  - » Limit position **b**: low seat position.
- Installing front seat (→ 78).

## Windscreen

### Adjusting windscreen

- Switch on the ignition.



- Press the top section of button **1**.
  - » Windscreen higher
- Press the bottom section of button **1**.
  - » Windscreen lower

## Clutch

### Adjusting clutch lever

 If the position of the clutch fluid reservoir is changed, air can enter the clutch system. Do not twist the handlebar fitting or the handlebars.◀

**!** Attempting to adjust the clutch lever while riding the motorcycle can lead to accidents. Do not attempt to adjust the clutch lever unless the motorcycle is at a standstill.◀



- Turn adjusting screw **1** clockwise.

**▷** The adjusting screw is easier to turn if you push the clutch lever forward.◀

- » Span between handlebar grip and clutch lever increases.
- Turn adjusting screw **1** counter-clockwise.

» Span between handlebar grip and clutch lever decreases.

## Brakes

### Adjusting handbrake lever

**!** Changing the position of the brake-fluid reservoir can allow air to penetrate the brake system.

Do not twist the handlebar fitting or the handlebars.◀

**!** Attempting to adjust the brake lever while riding the motorcycle can lead to accidents. Do not attempt to adjust the brake lever unless the motorcycle is at a standstill.◀

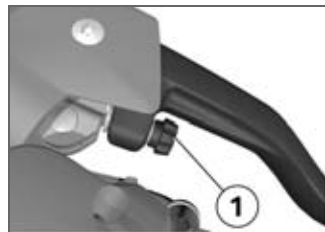

- Turn adjusting screw **1** clockwise.

**▷** The adjusting screw is easier to turn if you push the handbrake lever forward.◀

- » Span between handlebar grip and handbrake lever increases.
- Turn adjusting screw **1** counter-clockwise.
- » Span between handlebar grip and handlebar lever decreases.

## Handlebars

### Adjustable handlebars

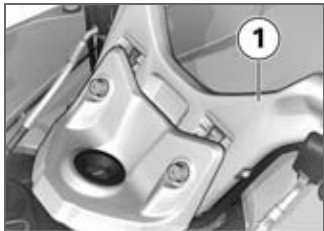

Handlebars **1** are height-adjustable. If you want to have the handlebars adjusted consult a specialist workshop, preferably an authorised BMW Motorrad dealer.

## Mirrors

### Adjusting mirrors



- Pivot the mirror to the correct position by pressing gently at the edge.

### Spring preload Setting

It is essential to set spring preload of the rear suspension to suit the load carried by the motorcycle. Increase spring preload when the motorcycle is heavily loaded and reduce spring preload

accordingly when the motorcycle is lightly loaded.

### Adjusting spring preload for rear wheel

- Make sure the ground is level and firm and place the motorcycle on its stand.



 Your motorcycle's handling will suffer if you do not match the spring-preload and damping-characteristic settings. Adjust the damping characteristic to suit spring preload.◀

 Adjusting spring preload while the motorcycle is being ridden can lead to accidents. Do not attempt to adjust spring preload unless the motorcycle is at a standstill. ◀

- If you want to increase spring preload, turn knob **1** in the direction indicated by the HIGH arrow.
- If you want to reduce spring preload, turn knob **1** in the direction indicated by the LOW arrow.

 Basic setting of spring preload, rear

– without Electronic Suspension Adjustment (ESA II)<sup>OE</sup>



Basic setting of spring preload, rear

- Turn the knob as far as it will go in the direction indicated by the LOW arrow and then turn it back 13 clicks in the direction indicated by the HIGH arrow. (Full load of fuel, with rider 85 kg) ◀

## Damping Setting

Damping must be adapted to suit the surface on which the motorcycle is ridden and to suit spring preload.

- An uneven surface requires softer damping than a smooth surface.
- An increase in spring preload requires firmer damping, a reduction in spring preload requires softer damping.

## Adjusting damping for rear wheel

- Make sure the ground is level and firm and place the motorcycle on its stand.



- Adjust the damping characteristic, using the tool from the on-board toolkit to turn adjusting screw **1**.

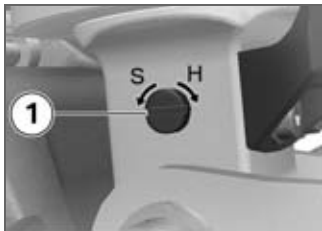

- If you want a harder damping characteristic, turn adjusting screw **1** in the direction indicated by the H arrow.
- If you want a softer damping characteristic, turn adjusting screw **1** in the direction indicated by the S arrow.



Basic setting of rear-suspension damping characteristic

- Turn the adjusting screw as far as it will go in the direction indicated by the H arrow and then turn it back one and a half turns in the direction indicated by the S arrow. (Full load of fuel, with rider 85 kg)◁

## Electronic Suspension Adjustment ESA

- with Electronic Suspension Adjustment (ESA II)<sup>OE</sup>

### Settings

Electronic Suspension Adjustment ESA provides a convenient way of adapting the motorcycle to the load it carries and the surface over which you intend riding. In order for this to happen, the



Basic setting of rear-suspension damping characteristic

- without Electronic Suspension Adjustment (ESA II)<sup>OE</sup>

load status must be set and the desired riding mode selected.



The selected riding mode is displayed in panel **1** of the multifunction display and the load status is displayed in panel **2**. Three load statuses can be set, with any of the three riding modes available for each one. The clock is not shown while the ESA readout is active.

Further information on the ESA Electronic Suspension Adjustment system can be found on page (➔ 99).

## Calling up settings

- Switch on the ignition.



- Press button **1**.
  - » The current setting is displayed.
  - » The reading remains visible for a few seconds before disappearing automatically.

## Setting the riding mode

- Start the engine.

 The riding mode can be set while the motorcycle is in motion. ◀



- Press button **1**.
  - » The current setting is displayed.
- Press button **1** once at each step.

The display field starts at the current status and cycles through the following sequence:

- COMF: comfort mode
- NORM: normal mode
- SPORT: sport mode
- » The setting shown on the display is automatically accepted as the riding mode if you allow a certain length of time to pass without making further

changes. The display is automatically hidden again shortly after the settings are completed.

## Setting the load status

- Start the engine.

 The load status cannot be set while the motorcycle is in motion. ◀



- Press button **1**.
  - » The current setting is displayed.
- Press and hold down button **1** until the reading changes.

The display field starts at the current status and cycles through the following sequence:



One-up



One-up with luggage



Two-up (with luggage)

» The setting shown on the display is automatically accepted as the load status if you allow a certain length of time to pass without making further changes.

## Tyres

### Checking tyre pressure



Incorrect tyre pressures impair the motorcycle's handling characteristics and increase the rate of tyre wear.

Always check that the tyre pressures are correct. ◀



At high road speeds, tyre valves installed perpendicular to the wheel rim have a tendency to open as a result of centrifugal force.

In order to avoid a sudden loss of tyre pressure, fit a valve cap with rubber sealing ring to the rear tyre and make sure that the cap is screwed on firmly. ◀

- Make sure the ground is level and firm and place the motorcycle on its stand.
- Check tyre pressures against the data below.



Tyre pressure, front

– 2.5 bar (one-up, tyre cold)

– 2.5 bar (two-up and/or with luggage, tyre cold)



Tyre pressure, rear

– 2.9 bar (one-up, tyre cold)

– 2.9 bar (two-up and/or with luggage, tyre cold)

If tyre pressure is too low:

- Correct tyre pressure.

## Headlight

### Adjusting headlight for driving on left/driving on right

If the motorcycle is ridden in a country where the opposite rule of the road applies, its asymmetric low-beam headlight will tend to dazzle oncoming traffic. Have the headlight set accordingly by a specialist workshop, preferably an authorised BMW Motorrad dealer.

 Commercially available adhesive tape will damage the plastic lens of the light.

Consult a specialist workshop, preferably an authorised BMW Motorrad dealer, in order to avoid damaging the plastic lens of the light. ◀

### Headlight beam throw and spring preload

Headlight beam throw is generally kept constant when spring preload is adjusted to suit load. Spring preload adjustment might not suffice only if the motorcycle is very heavily loaded. Under these circumstances, headlight beam throw has to be adjusted to suit the weight carried by the motorcycle.

 Consult a specialist workshop, preferably an authorised BMW Motorrad dealer, if you are unsure whether

the headlight basic setting is correct. ◀

### Headlight beam-throw adjustment



**1** Headlight beam-throw adjustment

Spring preload adjustment might not suffice if the motorcycle is very heavily loaded. Moving the pivot lever adjusts headlight beam throw so as not to dazzle oncoming traffic.

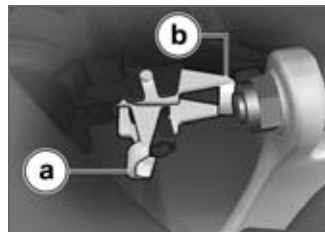

**a** Neutral position  
**b** Position for heavy load

## Stowage compartment

### Operating the stowage compartment



- Use the ignition key to turn lock barrel **1** to right angles with the forward direction of travel.
  - » Lock of the stowage compartment locked.
- Turn the lock barrel **1** in direction of travel using the ignition key.
  - » Lock of the stowage compartment unlocked.

- To open the lid, push the unlocked lock barrel downwards.
  - » The lid opens.

## Front and rear seats

### Remove the rear seat

- Make sure the ground is level and firm and place the motorcycle on its stand.



- Turn the key anti-clockwise in the seat lock **1**.



- Lift the seat at the rear and release the key.
  - with seat heating<sup>OE</sup>

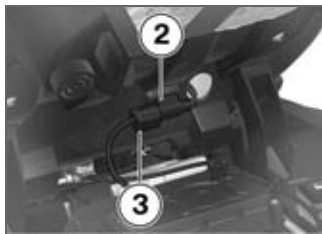

- Disconnect plug **2** using latch **3**.<

- Pull the seat to the rear to release it from its holders.
- Place the seat, upholstered side down, on a clean surface.

### Remove the front seat

- Remove the rear seat (→ 77).

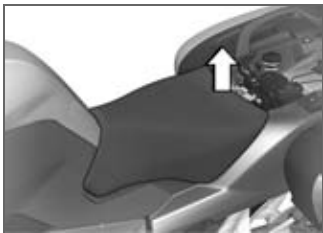

- Lift the rear of the front seat.

– with seat heating<sup>OE</sup>

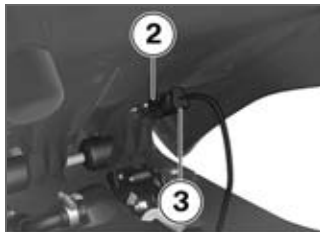

- Disconnect plug **2** using latch **3**.<
- Lift the seat up to remove.
- Place the seat, upholstered side down, on a clean surface.

### Installing front seat

– with seat heating<sup>OE</sup>



- Connect plug **2**.<

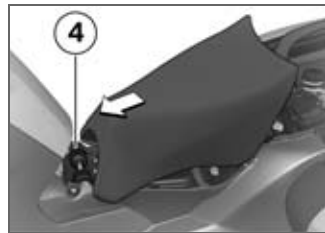

- Push the front seat forward into seat height adjuster **4**. Make

sure that the seat is correctly located.

- Installing rear seat (⇒ 79).

## Installing rear seat

- Installing front seat (⇒ 78).  
– with seat heating<sup>OE</sup>



- Connect plug **2**.◀

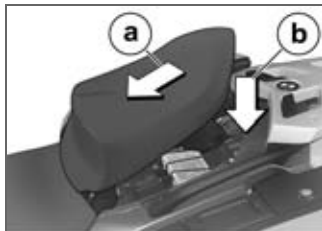

- Slide the rear seat underneath front seat **a** and push it down firmly at the rear **b**.  
» The seat engages with an audible click.

## Helmet holder

- Remove the rear seat (⇒ 77).



The helmet catch can scratch the panelling. Make sure the lock is out of the way when you hook the helmet into position.◀

- Hang the helmet's chinstrap on helmet holder **1**.
- Installing rear seat (⇒ 79).



## **Riding**

Safety instructions .....	82
Checklist .....	84
Starting .....	84
Running in .....	87
Brakes .....	87
Parking your motorcycle .....	89
Refuelling .....	90
Securing motorcycle for transportation .....	92

## Safety instructions

### Rider's equipment

Do not ride without the correct clothing. Always wear:

- Helmet
- Motorcycling jacket and trousers
- Gloves
- Boots

This applies even to short journeys, and to every season of the year. Your authorised BMW Motorrad dealer will be glad to advise you on the correct clothing for every purpose.

### Speed

If you ride at high speed, always bear in mind that various boundary conditions can adversely affect the handling of your motorcycle:

- Settings of the spring-strut and shock-absorber system
- Imbalanced load
- Loose clothing
- Insufficient tyre pressure
- Poor tyre tread
- Etc.

### Correct loading



Overloading and imbalanced loads can adversely affect the motorcycle's handling. Do not exceed the permissible gross weight and be sure to comply with the instructions on loading.◀

### Alcohol and drugs



Even small amounts of alcohol or drugs will adversely affect your perception and your ability to assess situations and make decisions, and slow down your reflexes. Medication can exacerbate these effects.

Do not ride your motorcycle after consuming alcohol, drugs and/or medication.◀

### Risk of poisoning

Exhaust fumes contain carbon monoxide, which is colourless and odourless but highly toxic.



Inhaling the exhaust fumes therefore represents a health hazard and can even cause loss of consciousness with fatal consequences.

Do not inhale exhaust fumes. Do not run the engine in an enclosed space.◀

### High voltage



Touching live parts of the ignition system with the engine running can cause electric shock.

Do not touch parts of the ignition system when the engine is running.◀

## Catalytic converter

If misfiring causes unburned fuel to enter the catalytic converter, there is a danger of overheating and damage.

For this reason, observe the following points:

- Do not run the fuel tank dry.
- Do not attempt to start or run the engine with a spark-plug cap disconnected.
- Stop the engine immediately if it misfires.
- Use only unleaded fuel.
- Comply with all specified maintenance intervals.

 Unburned fuel will destroy the catalytic converter. Note the points listed for protection of the catalytic converter.◀

## Risk of fire

Temperatures at the exhaust are high.

 Flammable materials (e.g. hay, leaves, grass, clothing and luggage, etc.) could ignite if allowed to come into contact with the hot exhaust pipe.

Do not permit flammable materials to come into contact with the hot exhaust system.◀

 Cooling would be inadequate if the engine were allowed to idle for a lengthy period with the motorcycle at a standstill: overheating would result. In extreme cases, the motorcycle could catch fire. Do not allow the engine to idle unnecessarily. Ride away immediately after starting the engine.◀

## Tampering with the control unit of the electronic engine-management system

 Tampering with the engine control unit can damage the motorcycle and cause accidents.

Do not tamper with the engine control unit.◀

 Tampering with the engine control unit can result in mechanical loads that the motorcycle's components are not designed to withstand. Damage caused in this way is not covered by the warranty. Do not tamper with the engine control unit.◀

## Checklist

Use the following checklist to check important functions, settings and wear limits before you ride off.

- Brakes
- Brake-fluid levels, front and rear
- Clutch
- Clutch fluid level
- Shock absorber setting and spring preload
- Tyre-tread depth and tyre pressures
- Cases correctly installed and luggage secured

At regular intervals:

- Engine oil level (every refuelling stop)
- Brake-pad wear (every third refuelling stop)

## Starting

### Side stand

You cannot start the motorcycle with the side stand extended and a gear engaged. The engine will switch itself off if you start it with the gearbox in neutral and then engage a gear before retracting the side stand.

### Gearbox

You can start the engine when the gearbox is in neutral or if you pull the clutch with a gear engaged. Do not pull the clutch until after you have switched on the ignition, as otherwise the engine will refuse to start. When the gearbox is in neutral, the green neutral telltale light is on and the gear indicator in the multifunction display shows N.

## Starting engine

- Switch on the ignition.
  - » Pre-ride check is performed. (⇒ 85)
  - » ABS self-diagnosis is performed. (⇒ 85)
- with Automatic Stability Control<sup>OE</sup>
  - » ASC self-diagnosis is performed. (⇒ 86)



- Press starter button **1**.

▶ If ambient temperatures are very low, you might find it necessary to open the throttle slightly when starting the engine.

At ambient temperatures below 0 °C, disengage the clutch after switching on the ignition. ◀

 The start attempt is automatically interrupted if battery voltage is too low. Recharge the battery before you start the engine, or use jump leads and a donor battery to start. ◀

- » The engine starts.
- » Consult the troubleshooting chart below if the engine refuses to start. (➔ 144)

## Pre-ride check

The instrument panel runs a test of the 'General' warning light when the ignition is switched on: this is the "Pre-Ride-Check" The warning light shows first red and then yellow, so that you can check that it is in working order. The test is aborted if you start the engine before it completes.

For initialisation, the exhaust flap is opened fully once and then closed again.

### Phase 1



General warning light shows red.

- CHECK ! appears on the display.

### Phase 2



General warning light shows yellow.

- CHECK ! appears on the display.
- with cruise control system<sup>OE</sup>



The SET light lights up.

If the 'General' warning light does not show:



Some malfunctions cannot be indicated if the 'General' warning light cannot be displayed.

Check that the 'General' warning light comes on, and that it shows red and yellow. ◀

- Have the fault rectified as quickly as possible by a specialist workshop, preferably an authorised BMW Motorrad dealer.

## ABS self-diagnosis

BMW Motorrad Integral ABS performs self-diagnosis to ensure its operability. Self-diagnosis is performed automatically when you switch on the ignition. The motorcycle has to move forward at a speed above 5 km/h for the wheel sensors to be tested.

### Phase 1

- » Test of the diagnosis-compatible system components with the motorcycle at a standstill.



ABS warning light flashes.



Possible national variant of the ABS warning light.

## Phase 2

» Test of the wheel sensors as the motorcycle pulls away from rest.



ABS warning light flashes.



Possible national variant of the ABS warning light.

## ABS self-diagnosis completed

» The ABS warning light goes out.

If an indicator showing an ABS fault appears when ABS self-diagnosis completes:

- You can continue to ride. Bear in mind that neither the ABS function nor the integral braking function is available.
- Have the fault rectified as quickly as possible by a

specialist workshop, preferably an authorised BMW Motorrad dealer.

## ASC self-diagnosis

– with Automatic Stability Control<sup>OE</sup>

BMW Motorrad ASC performs self-diagnosis to ensure its operability. Self-diagnosis is performed automatically when you switch on the ignition. The engine must be running and the motorcycle must reach a speed of at least 5 km/h in order for ASC self-diagnosis to complete.

## Phase 1

» Test of the diagnosis-compatible system components with the motorcycle at a standstill.



ASC warning light slow-flashes.

## Phase 2

» Test of the diagnosis-compatible system components while the motorcycle is on the move.



ASC warning light slow-flashes.

## ASC self-diagnosis completed

» The ASC symbol no longer shows.

If an indicator showing an ASC fault appears when ASC self-diagnosis completes:

- You can continue to ride. Bear in mind that the ASC function is not available.
- Have the fault rectified as quickly as possible by a specialist workshop, preferably an authorised BMW Motorrad dealer.

## Running in

### The first 1000 km

- While running in the motorcycle, vary the throttle opening and engine-speed range frequently.
- Try to do most of your riding during this initial period on twisting, fairly hilly roads, avoiding high-speed main roads and highways if possible.

 Exceeding the specified engine speeds while running in will lead to increased engine wear.

Keep to the specified engine speeds for running in. ◀

- Do not exceed the rpm limits recommended for running in.

	Running-in speed
– <7000 min <sup>-1</sup>	

- No full-load acceleration.

- Avoid low engine speeds at full load.
- Do not omit the first inspection after 500 - 1200 km.

### Brake pads

New brake pads must "bed down" and therefore do not achieve their optimum friction levels during the first 500 km. You can compensate for this initial reduction in braking efficiency by exerting greater pressure on the levers.

 New brake pads can extend stopping distance by a significant margin. Apply the brakes in good time. ◀

### Tyres

New tyres have a smooth surface. This must be roughened by riding in a restrained manner at various heel angles until the tyres are run in. This running in pro-

cedure is essential if the tyres are to achieve maximum grip.

 Tyres do not have their full grip when new and there is a risk of accidents at extreme angles of heel. Avoid extreme angles of heel. ◀

## Brakes

### How can stopping distance be minimised?

Each time the brakes are applied, a load distribution shift takes place with the load shifting forward from the rear to the front wheel. The sharper the motorcycle decelerates, the more load is shifted to the front wheel. The higher the wheel load, the more braking force can be transmitted without the wheel locking. To optimise stopping distance, apply the front brakes rapidly and keep on increasing the force you apply to the brake lever. This

makes the best possible use of the dynamic increase in load at the front wheel. Remember to pull the clutch at the same time. In the "panic braking situations" that are trained so frequently braking force is applied as rapidly as possible and with the rider's full force applied to the brake levers; under these circumstances the dynamic shift in load distribution cannot keep pace with the increase in deceleration and the tyres cannot transmit the full braking force to the surface of the road. ABS has to intervene to keep the front wheel from locking; this increases stopping distance.

### **Descending mountain passes**

 There is a danger of the brakes fading if you use only the rear brakes when descending mountain passes. Under

extreme conditions, the brakes could overheat and suffer severe damage.

With the BMW integrated brake system, the rear brake is activated when the handbrake lever is pressed. This protects against overheating. Only use the front brake and utilise engine braking. ◀

### **Wet brakes**

 After the motorcycle has been washed, ridden through water or ridden in the rain, the brake discs and pads might be wet and the brakes might not take effect immediately.

Apply the brakes in good time until the brakes have dried out. ◀

### **Salt on brakes**

 The brakes may fail to take effect immediately if the motorcycle was ridden on salt-covered roads and the brakes were not applied for some time. Apply the brakes in good time until the salt layer on the brake discs and brake pads has been removed. ◀

### **Oil or grease on brakes**

 Oil and grease on the brake discs and pads considerably diminish braking efficiency. Especially after repair and maintenance work, make sure that the brake discs and brake pads are free of oil and grease. ◀

### **Dirt or mud on brakes**

 When riding on loose surfaces or muddy roads, the brakes may fail to take effect immediately because of dirt or

moisture on the discs or brake pads.

Apply the brakes in good time until the brakes have been cleaned.◀

## Parking your motorcycle

### Placing motorcycle on side stand

 If the ground is soft or uneven, there is no guarantee that the motorcycle will rest firmly on the stand.

Always check that the ground under the stand is level and firm.◀

- Switch off the engine.
- Pull the handbrake lever.
- Hold the motorcycle upright and balanced.
- Use your left foot to extend the side stand fully.

 The side stand is designed to support only the weight of the motorcycle.

Do not lean or sit on the motorcycle with the side stand extended.◀

- Slowly lean the motorcycle to the side until its weight is taken by the stand and dismount to the left.

 If the motorcycle is on the side stand, the surface of the ground will determine whether it is better to turn the handlebars to the left or right. However, the motorcycle is more stable on a level surface with the handlebars turned to the left than with the handlebars turned to the right.

On level ground, always turn the handlebars to the left to set the steering lock.◀

- Turn the handlebars to full left or right lock.

- Check that the motorcycle is standing firmly.

 On a gradient, the motorcycle should always face uphill; select 1st gear.◀

- Lock the steering lock.

### Removing motorcycle from side stand

- Unlock the steering lock.
- From the left, grip the handlebars with both hands.
- Pull the handbrake lever.
- Swing your right leg over the seat and lift the motorcycle to the upright position.
- Hold the motorcycle upright and balanced.

 An extended side stand can catch on the ground when the motorcycle is moving and lead to a fall.

Retract the side stand before moving the motorcycle.◀

- Sit on the motorcycle and use your left foot to retract the side stand.

## Placing motorcycle on centre stand

 If the ground is soft or uneven, there is no guarantee that the motorcycle will rest firmly on the stand.

Always check that the ground under the stand is level and firm. ◀

- Switch off the engine.
- Dismount and keep your left hand on the left handlebar grip.
- With your right hand, grip the rear grab handle or the rear frame.
- Use your right foot on the pin of the centre stand to press the stand down until its curved feet touch the ground.
- Place your full body weight on the centre stand and at the

same time pull the motorcycle to the rear.

 Excessive movements could cause the centre stand to retract, and the motorcycle would topple in consequence.

Do not lean or sit on the motorcycle with the centre stand extended. ◀

- Check that the motorcycle is standing firmly.
- Lock the steering lock.

## Removing motorcycle from centre stand

- Unlock the steering lock.
- Place your left hand on the left handlebar grip.
- With your right hand, grip the rear grab handle or the rear frame.
- Push the motorcycle forward off the centre stand.

- Check that the centre stand has fully retracted.

## Refuelling

 Fuel is highly flammable. A naked flame close to the fuel tank can cause a fire or explosion.

Do not smoke. Never bring a naked flame near the fuel tank. ◀

 Fuel expands when hot. Fuel escaping from an overfilled tank could make its way onto the rear tyre. This could cause a fall.

Do not fill the tank past the bottom edge of the filler neck. ◀

 Fuel attacks plastics, which become dull or unsightly. Wipe off plastic parts immediately if they come into contact with fuel. ◀

 Fuel can attack the material of the windscreen, which becomes dull or unsightly. Wipe off the windscreen immediately if it comes into contact with fuel. ◀

 Leaded fuel will destroy the catalytic converter. Use only unleaded fuel. ◀

- Make sure the ground is level and firm and place the motorcycle on its stand.
- Open the protective cap.



- Open the fuel tank cap with the ignition key by turning it counter-clockwise.



- Refuel with fuel of the grade stated below; do not fill the

tank past the bottom edge of the filler neck.

 Recommended fuel grade

– 98 ROZ/RON (Premium plus unleaded)

– 95 ROZ/RON (Premium unleaded (fuel grade, usable with power- and consumption-related restrictions))

 Usable fuel capacity

– approx. 24 l

 Reserve fuel

–  $\geq 4$  l

- Press the fuel tank cap down firmly to close.
- Remove the key and close the protective cap.

## Securing motorcycle for transportation

- Make sure that all components that might come into contact with straps used to secure the motorcycle are adequately protected against scratching. Z. Use adhesive tape or soft cloths, for example, for this purpose.



 The motorcycle can topple and fall on its side.

Make sure that the motorcycle cannot topple sideways. ◀

- Push the motorcycle onto the transportation flat and hold it in position: do not place it on the side stand or centre stand.



 Risk of damaging components.

Take care not to trap components such as brake lines or wires. ◀

- At the front, place the strap over the frame and route it downwards.
- Feed the strap forwards through the wheel carrier and tighten it downwards.



- At the rear, secure the straps to the rear footrests on both sides and tighten the straps.
- Tighten all the straps uniformly; the motorcycle's suspension should be compressed as tightly as possible front and rear.

## Engineering details

Brake system with BMW Motorrad Integral ABS .....	94
Electronic engine management with BMW Motorrad ASC .....	96
Tyre pressure monitoring RDC .....	98
Electronic Suspension Adjustment ESA II .....	99

## Brake system with BMW Motorrad Integral ABS

### Partially integral brakes

Your motorcycle is equipped with partially integral brakes. Both front and rear brakes are applied when you pull the handbrake lever. The footbrake lever acts only on the rear brake.

While the brakes are slowing the motorcycle, the BMW Motorrad Integral ABS adapts braking-force distribution between front and rear brakes to suit the load on the motorcycle.

 The integral braking function makes it very difficult to spin the rear wheel by opening the throttle with the front brake applied to keep the motorcycle stationary (burn-out). Attempted burn-outs can result in damage to the rear brake and the clutch. Do not attempt burn-outs. ◀

### How does ABS work?

The amount of braking force that can be transferred to the road depends on factors that include the coefficient of friction of the road surface. Loose stones, ice and snow or a wet road all have much lower coefficients of friction than a clean, dry asphalt surface. The lower the coefficient of friction, the longer the braking distance.

If the rider increases braking pressure to the extent that braking force exceeds the maximum transferrable limit, the wheels start to lock and the motorcycle loses its directional stability; a fall is imminent. Before this situation can occur, ABS intervenes and adapts braking pressure to the maximum transferrable braking force, so the wheels continue to turn and directional stability is maintained irrespective of the condition of the road surface.

### What are the effects of surface irregularities?

Humps and surface irregularities can cause the wheels to lose contact temporarily with the road surface; if this happens the braking force that can be transmitted to the road can drop to zero. If the brakes are applied under these circumstances the ABS has to reduce braking force to ensure that directional stability is maintained when the wheels regain contact with the road surface. At this instant the BMW Motorrad Integral ABS must assume an extremely low coefficient of friction, so that the wheels will continue to rotate under all imaginable circumstances, because this is the precondition for ensuring directional stability. As soon as it registers the actual circumstances, the system reacts instantly and adjusts brak-

ing force accordingly to achieve optimum braking.

### **What feedback does the rider receive from the BMW Motorrad Integral ABS?**

If the ABS system has to reduce braking force on account of the circumstances described above, vibration is perceptible through the handbrake lever.

When the handbrake lever is pulled, brake pressure is also built up at the rear wheel by the integral function. If the brake pedal is depressed after the handbrake lever is pulled, the brake pressure built up beforehand is perceptible as counter-pressure sooner than is the case when the brake pedal is depressed either before or at the same time as the brake lever is pulled.

### **Rear wheel lift**

Even under severe braking, a high level of tyre grip can mean that the front wheel does not lock up until very late, if at all. Consequently, ABS does not intervene until very late, if at all. Under these circumstances the rear wheel can lift off the ground, and the outcome can be a high-siding situation in which the motorcycle can flip over.



Severe braking can cause the rear wheel to lift off the ground.

When you brake, bear in mind that ABS control cannot be relied on in all circumstances to prevent the rear wheel from lifting clear of the ground.◀

### **What is the design baseline for BMW Motorrad Integral ABS?**

Within the limits imposed by physics, the BMW Motorrad Integral ABS ensures directional stability on any surface. The system is not optimised for special requirements that apply under extreme competitive situations off-road or on the track.

### **Special situations**

The speeds of the front and rear wheels are compared as one means of detecting a wheel's incipient tendency to lock. If the system registers implausible values for a lengthy period the ABS function is deactivated for safety reasons and an ABS fault message is issued. Self-diagnosis has to complete before fault messages can be issued. In addition to problems with the BMW Motorrad Integral ABS,

exceptional riding conditions can lead to a fault message being issued.

### Exceptional riding conditions:

- Heating up with the motorcycle on the centre stand or an auxiliary stand, engine idling or with a gear engaged.
- Rear wheel locked by the engine brake for a lengthy period, for example while descending off-road.

If a fault message is issued on account of exceptional riding conditions as outlined above, you can reactivate the ABS function by switching the ignition off and on again.

## What significance devolves on regular maintenance?



Invariably, a technical system cannot perform beyond the abilities dictated by its level of maintenance.

In order to ensure that the BMW Motorrad ABS is always maintained in optimum condition, it is essential for you to comply strictly with the specified inspection intervals. ◀

## Reserves for safety

The potentially shorter braking distances which BMW Motorrad Integral ABS permits must not be used as an excuse for careless riding. ABS is primarily a means of ensuring a safety margin in genuine emergencies.

Take care when cornering. When you apply the brakes on a corner, the motorcycle's weight and

momentum take over and even BMW Motorrad Integral ABS is unable to counteract their effects.

## Electronic engine management with BMW Motorrad ASC

- with Automatic Stability Control<sup>OE</sup>

### How does ASC work?

The BMW Motorrad ASC compares the speed of rotation of the front wheel and the rear wheel. The differential is used to compute slip as a measure of the reserves of stability available at the rear wheel. If slip exceeds a certain limit the electronic engine management system intervenes, adapting engine torque accordingly.

## What is the design baseline for BMW Motorrad ASC?

BMW Motorrad ASC is designed as an assistant system for the rider and for use on public roads. The extent to which the rider affects ASC control can be considerable (weight shifts when cornering, items of luggage loose on the motorcycle), especially when style of riding takes rider and machine close to the limits imposed by physics. The system is not optimised for special requirements that apply under extreme competitive situations off-road or on the track. You have the option of deactivating the BMW Motorrad ASC system for these circumstances.



Even ASC is constrained by the laws of physics. Invariably, the rider bears responsibility for assessing road and traffic

conditions and adopting his or her style of riding accordingly. Do not take risks that would negate the additional safety offered by this system. ◀

### Special situations

In accordance with the laws of physics, the ability to accelerate is restricted more and more as the angle of heel increases. Consequently, there can be a perceptible lag in acceleration out of very tight bends.

The speeds of the front and rear wheels are compared as one means of detecting the rear wheel's incipient tendency to spin or slip sideways. If the system registers implausible values for a lengthy period the ASC function is deactivated for safety reasons and an ASC fault message is issued. Self-diagnos-

is has to complete before fault messages can be issued. The BMW Motorrad ASC can shut down automatically under the exceptional riding conditions outlined below.

### Exceptional riding conditions:

- Riding for a lengthy period with the front wheel lifted off the ground (wheelie) and ASC deactivated.
- Rear wheel rotating with the motorcycle held stationary by applying the front brake (burn-out).
- Heating up with the motorcycle on the centre stand or an auxiliary stand, engine idling or with a gear engaged.

Accelerating the motorcycle to a speed in excess of 10 km/h after switching the ignition off and then on again reactivates the ASC.

If the front wheel lifts clear of the ground under severe acceleration, the ASC reduces engine torque until the front wheel regains contact with the ground. Under these circumstances, BMW Motorrad recommends rolling the throttle slightly closed so as to restore stability with the least possible delay.

When riding on a slippery surface, never snap the throttle twistgrip fully closed without pulling the clutch at the same time. Engine braking torque can cause the rear wheel to lock, with a corresponding loss of stability. The BWM Motorrad ASC is unable to control a situation of this nature.

## Tyre pressure monitoring RDC

– with tyre pressure monitoring (RDC)<sup>OE</sup>

### Function

A sensor integrated into each tyre measures the air temperature and the air pressure inside the tyre and transmits this information to the control unit. Each sensor has a centrifugal-force tripswitch that does not enable transmission of the measured values until the motorcycle has accelerated to about 30 km/h. The display shows -- for each tyre until the tyre-pressure signal is received for the first time. The sensors continue to transmit the measured-value signals for approximately 15 minutes after the motorcycle comes to a stop.

The control unit can administer four sensors, so two dif-

ferent sets of wheels with RDC sensors can be alternated on the motorcycle. An error message is issued if wheels without sensors are fitted to a motorcycle equipped with an RDC control unit.

### Tyre-pressure ranges

The RDC control unit differentiates between three tyre-pressure ranges, all of which are parameterised for the motorcycle:

- Tyre pressure within permitted tolerance.
- Tyre pressure close to limit of permitted tolerance.
- Tyre pressure outside permitted tolerance.

### Temperature compensation

The tyre-pressure readings shown by the multifunction display are temperature-compensated; the reference tyre

temperature for these readings is always 20 °C. The air lines available to the public in petrol stations and motorway service areas almost invariably show temperature-dependent tyre pressures, so in most instances these gauge readings will not tally with the readings shown by the multifunction display.

### **Pressure adaptation**

Compare the RDC readings on the multifunction display with the value in the table on the inside cover of the Rider's Manual. Then use the air line to compensate for the difference between the RDC reading and the value in the table.

Example: According to the Rider's Manual, tyre pressure should be 2.5 bar, but the reading in the multifunction display is 2.3 bar, so pressure is low by 0.2 bar. The gauge on the air line shows

2.4 bar. You must now increase tyre pressure by the 0.2 bar difference between the value in the table and the RDC reading; when the air-line gauge shows 2.6 bar, the tyre is inflated to the correct pressure.

## **Electronic Suspension Adjustment ESA II**

– with Electronic Suspension Adjustment (ESA II)<sup>OE</sup>

### **Suspension adjustments**

Depending on the load on the motorcycle, the appropriate load status must first be selected when the motorcycle is stationary. The damping characteristics on both spring struts and the spring mount and the spring rate on the rear spring strut are adjusted on the basis of the riding mode that is then selected. If the selected driving mode is changed, the damping character-

istics on both spring struts and the spring rate on the rear spring strut are also adjusted. This allows the suspension to be very accurately adapted to all riding conditions, even when the motorcycle is in motion.

- The combination of spring mount, suspension and spring rate ensure that the suspension geometry is always perfectly adjusted.
- The static normal position is almost maintained even while riding.
- The different riding conditions and load statuses are compensated, so that the handling of the motorcycle remains constant.

It is possible to change the spring rate electronically by combining a conventional coil spring and a plastic element (Elastogran), the lateral expansion

of which can be restricted electro-hydraulically using a displaceable sleeve. The more the sleeve encloses the plastic element, the more the expansion of the plastic element is restricted, causing the spring rate to increase. The maximum spring rate is achieved when the sleeve completely encloses the plastic element and rests on the steel spring. By the same token, the spring rate decreases when the sleeve allows the plastic element to expand further.

## **Accessories**

General instructions.....	102
Power socket .....	102
Luggage .....	103
Case .....	104
Topcase .....	106

## General instructions

BMW Motorrad recommends the use of parts and accessories for your motorcycle that are approved by BMW for this purpose. Genuine BMW parts and accessories and other products which BMW has approved can be obtained from your authorised BMW Motorrad dealer, together with expert advice on their installation and use.

These parts and products have been tested by BMW for safety, function and suitability. BMW accepts product liability for them. Conversely, BMW is unable to accept any liability whatsoever for parts and accessories which it has not approved.

 BMW Motorrad cannot assess each non-BMW product to determine whether it can be used on or in connection with BMW motorcycles

without constituting a safety hazard. Country-specific official authorisation does not suffice as assurance. Tests conducted by these instances cannot make provision for all operating conditions experienced by BMW motorcycles and, consequently, they are not sufficient in some circumstances.

Use only parts and accessories approved by BMW for your motorcycle. ◀

Whenever you are planning modifications, comply with all the legal requirements. Make sure that the motorcycle does not infringe national road-vehicle construction and use regulations.

## Power socket

### Ratings



The supply to the socket **1** is cut off automatically if battery voltage is too low or the load exceeds the maximum rating.

### Operating electrical accessories

You can start using electrical accessories only when the ignition is switched on. The accessory remains operational if the ignition is subsequently switched off. In order to ensure that the drain on the on-board power supply sys-

tem is minimised, the supply to the power socket is cut off approximately 15 minutes after the ignition is switched off, and it is also temporarily interrupted during the start procedure.

## Cable routing

The cables from the power socket to the auxiliary device must be routed in such a way that they:

- Do not impede the rider
- Do not restrict or obstruct the steering angle and handling characteristics
- Cannot be trapped



Incorrectly routed cables can impede the rider. Route the cables as described above. ◀

## Luggage

### Correct loading



Overloading and imbalanced loads can adversely affect the motorcycle's handling. Do not exceed the permissible gross weight and be sure to comply with the instructions on loading. ◀

- Set spring preload, damping characteristic and tyre pressures to suit total weight.
- Ensure that the case volumes on the left and right are equal.
- Make sure that the weight is uniformly distributed between right and left.
- Pack heavy items at the bottom and toward the inboard side.
- Note the maximum permissible payload of the cases and the speed limit for riding with cases on the motorcycle.



Payload of cases

-  $\leq 8$  kg



Maximum permissible speed for riding with cases fitted to the motorcycle

-  $\leq 180$  km/h

- with large topcase<sup>OA</sup>

or

- with small topcase<sup>OA</sup>

- Note the maximum permissible payload of the topcase and the speed limit for riding with a topcase on the motorcycle.



Payload of topcase

- with small topcase<sup>OA</sup>

-  $\leq 5$  kg◀

- with large topcase<sup>OA</sup>

-  $\leq 10$  kg◀

 Maximum permissible speed for riding with top-case fitted to the motorcycle

–  $\leq 180$  km/h  $\triangleleft$

– with tank rucksack<sup>OA</sup>

- Note the maximum permissible payload of the tank rucksack.

 Payload of tank rucksack

– max 5 kg  $\triangleleft$

## Case

### Opening cases



- Turn the key to the OPEN position in the case lock.
- » The case is unlocked.

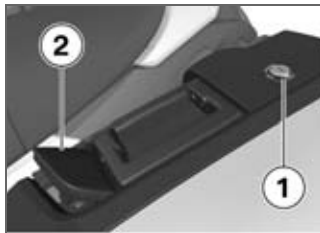

- Press lock barrel **1**.

- » Lever **2** pops up.
- Pull the release lever up.
- » The lid of the case opens.

### Closing cases

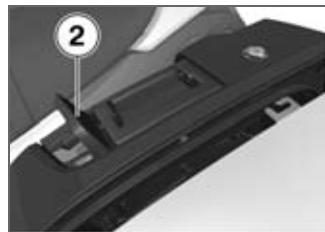

- Pull release lever **2** all the way up.
- Close the lid of the case and press it down. Check that nothing is trapped between the lid and the case.

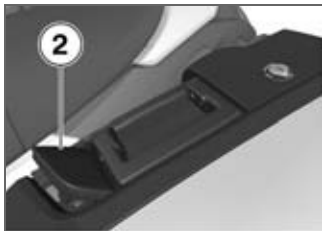

- Push release lever **2** down.
  - » The release lever engages.
- Turn the key to the LOCK position in the case lock.
  - » The case is closed.

## Removing the case



- Turn the key to the RELEASE position in the case lock.
  - » The handle pops out.

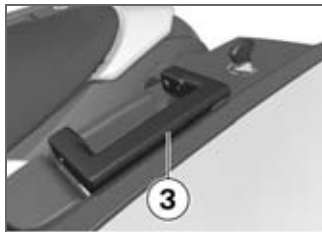

- Pull handle **3** out and then pull it up as far as it will go.

» The case is released and can be removed.

## Installing cases

- Pull the handle up as far as it will go.



- Seat the case in holders **4**.

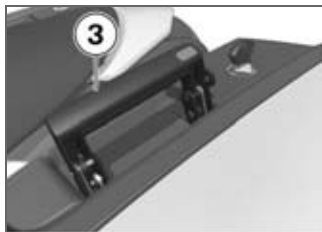

- Push handle **3** down until it engages.
  - » The case is correctly engaged on its holders.
- Turn the key to the LOCK position in the case lock.
  - » The case is closed.
- Check that the case is secure.

## Topcase

- with large topcase<sup>OA</sup>
- or
- with small topcase<sup>OA</sup>

## Opening topcase



- Turn the key to the OPEN position in the topcase lock.
  - » The topcase is unlocked.



- Press lock barrel **1**.
  - » Lever **2** pops up.

- Pull the release lever up.
  - » The lid of the topcase opens.

## Closing topcase



- Pull release lever **2** all the way up.
- Close the lid of the topcase and press it down. Check that nothing is trapped between the lid and the case.



- Push release lever **2** down.  
» The release lever engages.
- Turn the key to the LOCK position in the topcase lock.  
» The topcase is locked.

### Removing topcase

- Turn the key to the RELEASE position in the topcase lock.  
» The handle pops out.



- Pull handle **3** up as far as it will go.
- Lift the topcase at the rear and pull it off the luggage carrier.

### Installing topcase

- Pull the handle up as far as it will go.



- Hook the topcase into position on the luggage carrier. Make sure that hooks **4** are securely seated in the corresponding keepers **5**.



- Push handle **3** down until it engages.
  - » The topcase is correctly engaged on its carrier.
- Turn the key to the LOCK position in the topcase lock.
  - » The topcase is locked.
- Check that the topcase is secure.

## Maintenance

General instructions.....	110
Toolkit .....	110
Engine oil .....	111
Brake system .....	113
Brake pads .....	113
Brake fluid .....	115
Clutch .....	117
Tyres .....	118
Rims .....	118
Wheels .....	118
Front-wheel stand .....	127
Bulbs .....	128
Jump starting .....	134
Battery.....	135

## General instructions

The Maintenance chapter describes straightforward procedures for checking and replacing certain wear parts.

Special tightening torques are listed as applicable. The tightening torques for the threaded fasteners on your motorcycle are listed in the section entitled "Technical data".

You will find information on more extensive maintenance and repair work in the Repair Manual on DVD for your motorcycle, which is available from your authorised BMW Motorrad dealer.

Some of the work calls for special tools and a thorough knowledge of motorcycle technology. If you are in doubt consult a specialist workshop, preferably your authorised BMW Motorrad dealer.

## Toolkit

### Toolkit

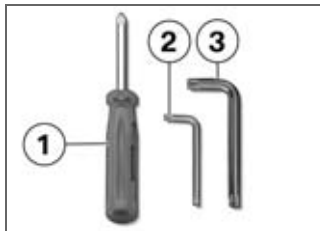

- 1 Reversible-blade screwdriver with star-head and plain tips
  - Adjusting damping for rear wheel (⇒ 72).
  - Replacing front turn indicator bulbs (⇒ 131).
  - Removing battery (⇒ 137).

- 2 Torx bit, T25
  - Replacing brake-light, rear-light and rear-indicator bulbs (⇒ 133).
  - Remove the battery-compartment cover (⇒ 138).
- 3 Torx wrench, T45
  - Adjusting handlebar height

## On-board toolkit service kit

- with service toolkit<sup>OA</sup>

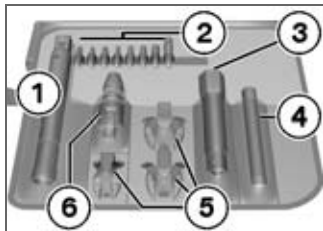

- 6** Adapter  
To accommodate the 1/4" bits and the 9x12 mm and the 3/8" universal-joint adapter

## Engine oil

### Checking engine oil level

**⚠** The engine can seize if the oil level is low, and this can lead to accidents. Always make sure that the oil level is correct. ◀

**⚠** Oil can collect in the sump if the motorcycle is out of use for an extended period of time; this oil has to be pumped into the oil tank before the level is read. The engine oil must be at operating temperature to do this. Checking the oil level with the engine cold or after no more than a short ride will lead to misinterpretation; this in turn, means

that the engine will be operated with the incorrect quantity of oil. In order to ensure that the engine oil level is read correctly, check the oil level only after a lengthy trip. ◀

- Check that the engine is at operating temperature, make sure the ground is level and firm and place the motorcycle on its centre stand.
- Allow the engine to idle for one minute.
- Switching off ignition
- Remove the front seat (➔ 78).
- Wipe the area around the oil filler neck clean.

- 1** Extending tool holder holds all tools by means of adapters, and for removing the spark plug
- 2** 1/4" bits
- 3** Bits of various sizes
- 4** 3/8" adapter for socket-head screws, w/f 22 for removing the quick-release axle from the front wheel
- 5** Electric torch
- 6** Socket
- Open-ended spanners of various sizes



- Remove oil filler cap **1** by turning it counter-clockwise.



- Use a dry cloth to wipe oil dipstick **2** clean

- Seat the oil dipstick on the oil filler neck, but do not engage the threads.
- Remove the oil dipstick and check the oil level.

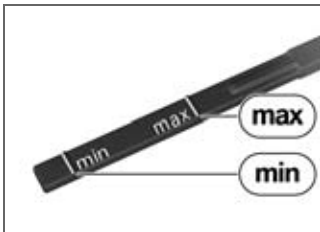

Engine oil, specified level

- between min and max marks  
(Seat the oil dipstick on the oil filler neck, but do not engage the threads.)

If the oil level is below the MIN mark:

- Top up the engine oil.

If the oil level is above the MAX mark:

- Have the oil level corrected by a specialist workshop, preferably an authorised BMW Motorrad dealer.

- Install the oil dipstick.
- Installing front seat (→ 78).

### Topping up engine oil

- Remove the front seat (→ 78).
- Wipe the area around the filler neck clean.



- Remove cap of oil filler neck **1** by turning it counter-clockwise.

 Damage to the engine can result if it is operated without enough oil, but the same also applies if the oil level is too high.

Always make sure that the oil level is correct. ◀

- Top up the engine oil to the specified level.
- Checking engine oil level (⇒ 111).
- Install cap of oil filler neck **1** and turn it clockwise to close.
- Installing front seat (⇒ 78).

## Brake system

### Reliability

A fully functional brake system is a basic requirement for the road safety of your motorcycle.

Do not ride the motorcycle if you have any doubts about the dependability of the brake system.

Under these circumstances have the brake system checked by a specialist workshop, preferably an authorised BMW Motorrad dealer.

 Incorrect working practices endanger the reliability of the brakes.

Have all work on the brake system performed by a specialist workshop, preferably an authorised BMW Motorrad dealer. ◀

### Check operation of the brakes

- Pull the handbrake lever.

- » The pressure point must be clearly perceptible.
- Press the footbrake lever.
- » The pressure point must be clearly perceptible.

## Brake pads

### Checking front brake pad thickness

 Brake pads worn past the minimum permissible thickness can cause a reduction in braking efficiency and under certain circumstances they can cause damage to the brake system.

In order to ensure the dependability of the brake system, do not permit the brake pads to wear past the minimum permissible thickness. ◀

- Make sure the ground is level and firm and place the motorcycle on its stand.



- Visually inspect the left and right brake pads to ascertain their thickness. Viewing direction: Between wheel and front suspension toward brake caliper **1**.



 Brake-pad wear limit, front

- min 1 mm (Friction pad only, without backing plate. The wear indicators (grooves) must be clearly visible.)

If the wear indicating mark is no longer clearly visible:

- Have the brake pads replaced by a specialist workshop, preferably an authorised BMW Motorrad dealer.

## Checking rear brake pad thickness

 Brake pads worn past the minimum permissible thickness can cause a reduction in braking efficiency and under certain circumstances they can cause damage to the brake system.

In order to ensure the dependability of the brake system, do not permit the brake pads to wear past the minimum permissible thickness.◀

- Make sure the ground is level and firm and place the motorcycle on its stand.



- Visually inspect the brake pads to ascertain their thickness. Viewing direction: from the right toward brake calliper **1**.



Brake-pad wear limit, rear

- min 1.0 mm (Friction pad only, without backing plate. Make sure that the brake disc is not visible through the bore in the inboard brake pad.)

If the brake disc is visible:

- Have the brake pads replaced by a specialist workshop, preferably an authorised BMW Motorrad dealer.

## Brake fluid

### Checking brake-fluid level, front brakes

- Make sure the ground is level and firm and place the motor-cycle on its centre stand.
- Move the handlebars to the straight-ahead position.



 A low fluid level in the brake reservoir can allow air to penetrate the brake system. This significantly reduces braking efficiency. Check the brake-fluid level at regular intervals.◀

- Check the brake fluid level in brake fluid reservoir **1**.

▷ The brake fluid level in the brake fluid reservoir drops as the brake pads wear.◀



Brake fluid level, front

– DOT4 brake fluid

– Do not permit the brake fluid level to drop below the MIN mark. (Brake-fluid reservoir horizontal, motorcycle upright and handlebars centred)

If the brake fluid level drops below the permitted level:

- Have the defect rectified as quickly as possible by a specialist workshop, preferably an authorised BMW Motorrad dealer.

### Checking brake-fluid level, rear brakes

- Make sure the ground is level and firm and place the motorcycle on its centre stand.
- Remove the rear seat (➔ 77).



 A low fluid level in the brake reservoir can allow air to penetrate the brake system. This significantly reduces braking efficiency.

Check the brake-fluid level at regular intervals.◀

- Check the brake fluid level in brake fluid reservoir **1**.

▷ The brake fluid level in the brake fluid reservoir drops as the brake pads wear.◀



Brake fluid level, rear

– DOT4 brake fluid

– Do not permit the brake fluid level to drop below the MIN mark. (Brake-fluid reservoir horizontal, motorcycle up-right)

authorised BMW Motorrad dealer.

- Installing rear seat (→ 79).

## Clutch

### Checking clutch operation

- Pull the clutch lever.
    - » The pressure point must be clearly perceptible.
- If the pressure point is not clearly perceptible:

- Have the clutch checked by a specialist workshop, preferably an authorised BMW Motorrad dealer.

### Checking the clutch fluid level

- Make sure the ground is level and firm and place the motorcycle on its centre stand.
- Move the handlebars to the straight-ahead position.



- Check the clutch fluid level in clutch fluid reservoir **1**.

▶ Wear of the clutch causes the fluid level in the clutch fluid reservoir to rise. ◀



Clutch-fluid level (visual inspection)

– Do not permit the clutch fluid level to drop.

If the fluid level drops:



Unsuitable hydraulic fluids could cause damage to the clutch system.

Do not attempt to top up the system with fluids of any kind. ◀

- Have the defect rectified as quickly as possible by a specialist workshop, preferably an authorised BMW Motorrad dealer.

 The clutch system is filled with a special hydraulic fluid that does not have to be changed. ◀

## Tyres

### Checking tyre tread depth

 Your motorcycle's handling and grip can be impaired even before the tyres wear to the minimum tyre tread depth permitted by law.

Have the tyres changed in good time before they wear to the minimum permissible tread depth. ◀

- Make sure the ground is level and firm and place the motorcycle on its stand.
- Measure the tyre tread depth in the main tread grooves with wear marks.

 Tyres have wear indicators integrated into the main tread grooves. The tyre is worn out when the tyre tread has worn down to the level of the marks. The locations of the marks are indicated on the edge of the tyre, e.g. by the letters TI, TWI or by an arrow. ◀

If the tyre tread is worn to minimum:

- Replace tyre or tyres, as applicable.

## Rims

### Checking rims

- Make sure the ground is level and firm and place the motorcycle on its stand.

- Visually inspect the rims for defects.
- Have damaged rims checked and, if necessary, replaced by a specialist workshop, preferably an authorised BMW Motorrad dealer.

## Wheels

### Tyre recommendation

For each size of tyre BMW Motorrad tests and classifies as roadworthy certain makes. BMW Motorrad cannot assess the suitability or provide any guarantee of road safety for other tyres.

BMW Motorrad recommends using only tyres tested by BMW Motorrad.

You can obtain detailed information from your authorised BMW Motorrad dealer or on the Internet at [www.bmw-motorrad.com](http://www.bmw-motorrad.com).

## Effect of wheel size on suspension-control systems

Wheel size is very important as a parameter for the suspension-control systems ABS and ASC. In particular, the diameter and the width of a motorcycle's wheels are programmed into the control unit and are fundamental to all calculations. Any change in these influencing variables, caused for example by a switch to wheels other than those installed elsewhere, can have serious effects on the performance of the control systems.

The sensor rings are essential for correct road-speed calculation, and they too must match the motorcycle's control systems and consequently cannot be changed.

If you decide that you would like to fit non-standard wheels to your motorcycle, it is very important

to consult a specialist workshop beforehand, preferably an authorised BMW Motorrad dealer. In some cases, the data programmed into the control units can be changed to suit the new wheel sizes.

### RDC label

- with tyre pressure monitoring (RDC)<sup>OE</sup>

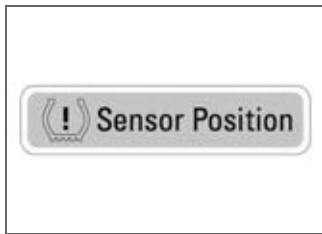

 Incorrect tyre-removal procedures can result in damage to the RDC sensors. Be sure to notify the authorised BMW Motorrad dealer or spe-

cialist workshop that the wheel is fitted with an RDC sensor. ◀

If the motorcycle is equipped with RDC, each wheel rim bears an adhesive label indicating the position of the RDC sensor. When changing the tyre, take care not to damage the RDC sensor. Be sure to draw the attention of the authorised BMW Motorrad dealer or specialist workshop to the fact that the wheel is fitted with an RDC sensor.

### Remove the front wheel

- Make sure the ground is level and firm and place the motorcycle on its centre stand.

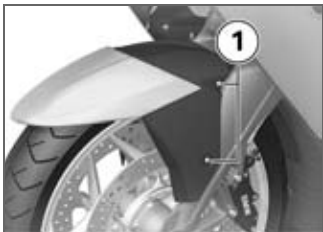

- Remove screws **1** on left and right.
- Pull the front-wheel cover forward to remove.



- Unclip the two retaining clips **1** holding the ABS sensor cable to the brake line.

- Mask off the parts of the wheel rim that could be scratched in the process of removing the brake calipers.



 Once the calipers have been removed, there is a risk of the brake pads being pressed together to the extent that they cannot be slipped back over the brake disc on re-assembly.

Do not operate the handbrake lever when the brake calipers have been removed. ◀

- Remove securing screws **2** of the left and right brake calipers.

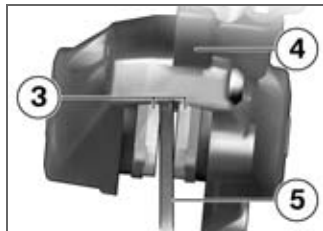

- Force the brake pads **3** slightly apart by rocking brake caliper **4** back and forth against brake disc **5**.
- Carefully pull the brake calipers back and out until clear of the brake discs.
- When removing the left brake caliper, take care not to damage the ABS sensor cable.



- Remove screw **1** and remove the ABS sensor from its bore.
- Raise front of motorcycle until the front wheel can turn freely. BMW Motorrad recommends the BMW Motorrad front-wheel stand for lifting the motorcycle.
- Installing front-wheel stand (→ 127).

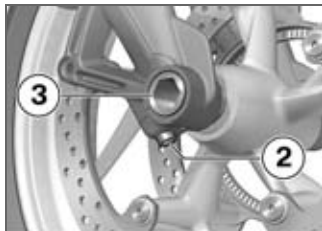

 The left axle clamping screw locates the threaded bush in the front suspension. If the threaded bush is not correctly aligned the gap between the ABS sensor ring and the ABS sensor will not be correct and this can cause the ABS to malfunction or allow the ABS sensor to be damaged. In order to ensure that the threaded bush remains correctly aligned, do not slacken or remove the left axle clamping screw.◀

- Remove right-hand axle clamping screw **2**.
- Remove quick-release axle **3**, while supporting the wheel.
- Lower the front wheel to the ground between the front forks.

 Take care not to damage the ABS sensor when rolling out the front wheel. Note the ABS sensor when rolling out the front wheel.◀

- Roll the front wheel forward to remove.

## Installing front wheel

 Possible malfunctions when ABS and ASC systems intervene if non-standard wheels are installed.

See the information on the effect of wheel size on the ABS and ASC systems at the start of this chapter.◀

 Threaded fasteners not tightened to the specified torque can work loose or their threads can suffer damage. Always have the security of the fasteners checked by a specialist workshop, preferably an authorised BMW Motorrad dealer. ◀

 The front wheel must be installed right way round to rotate in the correct direction. Note the direction-of-rotation arrows on the tyre or the wheel rim. ◀

- Roll the front wheel into position between the front forks.

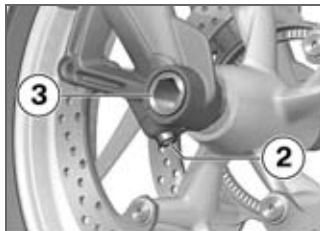

- Raise the front wheel, insert quick-release axle **3** and tighten to specified torque.



Quick-release axle in threaded bush

– 50 Nm

- Tighten right axle clamping screw **2** to the specified tightening torque.



Clamping bolt in wheel carrier

– 19 Nm

- Remove the front-wheel stand.



- Insert the ABS sensor into its bore and install screw **1**.
- Ease the brake calipers on to the brake discs.



- Install securing screws **2** on left and right and tighten to specified tightening torque.

 Front brake caliper to wheel carrier

– 30 Nm



- Clip on the two retaining clips **1** holding the ABS sensor cable to the brake line.
- Remove the adhesive tape from the wheel rim.
- Firmly pull the handbrake lever until the pressure point is perceptible, and repeat this operation several times.



- Hold the front-wheel cover in position and install bolts **1** on left and right.

## Removing rear wheel

- Make sure the ground is level and firm and place the motorcycle on its centre stand.

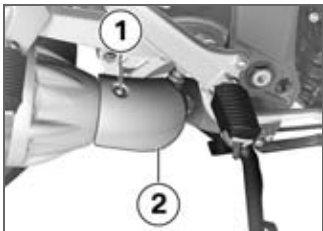

- Remove screw **1** from silencer cover **2**.
- Pull the cover to the rear to remove.



- Slacken bolt **3** on the clamp so that the clamp can just be turned.
- Do not remove the sealing grease from the clamp.



- Remove bolt **4** on the rear footrest while supporting the end silencer.

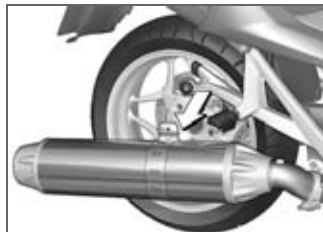

- First turn the end silencer slightly downwards and then turn it out.

- Engage first gear.



- Remove five bolts **1** from the rear wheel, while supporting the wheel.
- Lower the rear wheel to the ground and roll it out to the rear.

## Installing rear wheel

**⚠** Possible malfunctions when ABS and ASC systems intervene if non-standard wheels are installed.

See the information on the effect of wheel size on the ABS and

ASC systems at the start of this chapter. ◀

**⚠** Threaded fasteners not tightened to the specified torque can work loose or their threads can suffer damage. Always have the security of the fasteners checked by a specialist workshop, preferably an authorised BMW Motorrad dealer. ◀

- Roll the rear wheel into position at the rear-wheel adapter and attach it.



- Fit five bolts **1** and tighten to the specified torque in diagonally opposite sequence.

 Rear wheel to wheel flange

– Tightening sequence: tighten in diagonally opposite sequence

– 60 Nm

- Turn the end silencer to its initial position.



- Fit bolt **4** on the rear footrest and tighten to the specified tightening torque.



Silencer to rear footrest

– 22 Nm

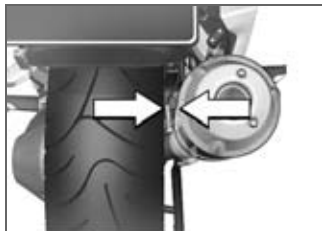

- Arrange the end silencer so that the handle of the reversible-blade screwdriver (toolkit) can fit between the wheel and the end silencer.

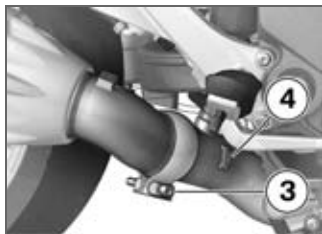

- Position the clamp as shown.

- Tighten bolt **3** of the clamp to the specified tightening torque.



Silencer with ball-joint clamp on manifold

– 35 Nm

- Seat silencer cover in mount **4**.

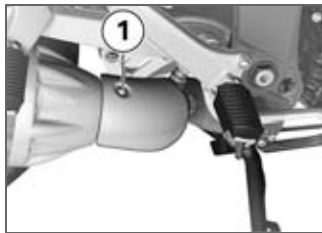

- Install screw **1**.

## Front-wheel stand

### Installing front-wheel stand

**!** The BMW Motorrad front wheel stand is not designed to support motorcycles not fitted with a centre stand or without other auxiliary stands. A motorcycle resting only on the front wheel stand and the rear wheel can topple.

Place the motorcycle on its centre stand or another auxiliary stand before lifting the front wheel with the BMW Motorrad front-wheel stand.◀

- Use basic stand with tool number (0 402 241) in combination with front-wheel adapter (0 402 243).
- Make sure the ground is level and firm and place the motorcycle on its centre stand.

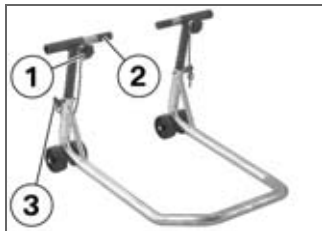

- Slacken adjusting screws **1**.
- Push the two pins **2** apart until the front suspension fits between them.
- Use locating pins **3** to set the front-wheel stand to the desired height.
- Centre the front-wheel stand relative to the front wheel and push it against the front axle.



**!** There is a risk of damaging the sensor ring of the BMW Motorrad Integral ABS.

Push the left pin in just far enough to ensure that it clears the sensor ring.◀

- Push both mounting pins **2** through the triangles of the brake caliper anchorages just far enough to allow the front wheel to be rolled between them.
- Tighten adjusting screws **1**.



**!** If the motorcycle is on the centre stand and is raised too far, the centre stand will lift clear of the ground and the motorcycle could topple to one side. When raising the motorcycle, make sure that the centre stand remains on the ground.◀

- Apply uniform pressure to push the front-wheel stand down and raise the motorcycle.

## Bulbs

### General instructions

A warning appears in the multi-function display if a bulb is defective. If the brake or rear light fails, the symbol is accompanied by the 'General' warning light, which lights up yellow.

**!** A defective bulb places your safety at risk because it is easier for other users to oversee the motorcycle. Replace defective bulbs as soon as possible; always carry a complete set of spare bulbs if possible.◀

**!** The bulb is pressurised and can cause injury if damaged. Wear protective goggles and gloves when changing bulbs.◀

▶ The types of bulb fitted to your motorcycle are listed

in the section entitled "Technical data".◀

▶ Do not touch the glass of new bulbs with your fingers. Use a clean, dry cloth to hold the bulbs when handling them. Dirt deposits, in particular oil and grease, interfere with heat radiation from the bulb. This leads to overheating and shortens the bulb's operating life.◀

### Replace xenon bulb

– with Xenon light<sup>OE</sup>

**!** Xenon lights operate with high voltage; incorrect working procedures can result in fatalities.

Have all work on the xenon light system, including bulb replacement, performed by a specialist workshop, preferably by an authorised BMW Motorrad dealer.◀

- For the time being, ride with the high-beam headlight switched on.
- In order not to dazzle oncoming traffic, set the headlight beam throw adjuster to the position for riding with maximum payload.
- Have the bulb replaced as soon as possible by a specialist workshop, preferably a BMW Motorrad authorised dealer.

## Replacing low-beam and high-beam headlight bulb

 The plug arrangement can differ from the illustration, depending on the bulb to be replaced. ◀

- Make sure the ground is level and firm and place the motorcycle on its stand.
- Switch off the ignition.

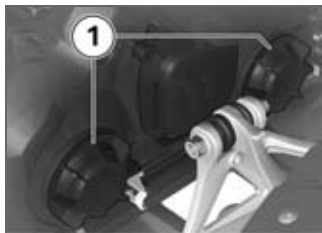

- Turn the covers **1** of the high-beam headlight anti-clockwise and remove.

– without Xenon light OE



- Remove the cover **2** of the low-beam headlight by pushing locking lever **3** downwards.

Swing the cover back and remove. ◀



- Disconnect plug **3**.



- Release spring clip **4** at left and right and swing it up.
- Remove bulb **5**.

- Replace the defective bulb.

 Bulbs for the low-beam headlight

– H7 / 12 V / 55 W

– with Xenon light<sup>OE</sup>

– D1R / 35 W<

 Bulb for high-beam headlight

– H7 / 12 V / 55 W

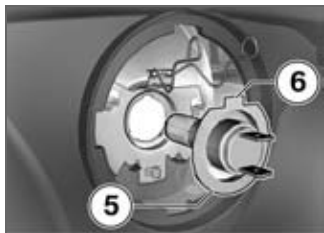

- Install bulb **5**, making sure that tab **6** is correctly positioned.



- Engage spring clip **4** in the catch on left and right.



- Close plug **3**.

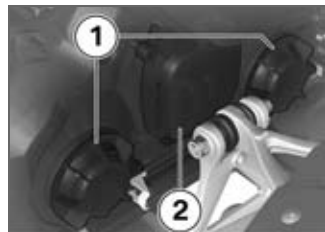

- Fit high-beam headlight covers **1** or low-beam headlight cover **2**.

### Replacing parking-light bulb

- Make sure the ground is level and firm and place the motorcycle on its stand.
- Switch off the ignition.



- Remove left side light bulb socket **1** by turning it anti-clockwise.



- Remove right side light bulb socket **2** by turning it anti-clockwise.



- Remove bulb **3** from the bulb holder.
- Replace the defective bulb.



Bulb for parking light

– W5W / 12 V / 5 W

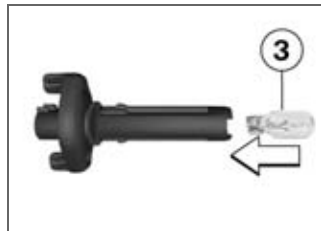

- Insert bulb **3** into the bulb socket.
- Install bulb socket in the appropriate place by turning it clockwise.

## Replacing front turn indicator bulbs

- Make sure the ground is level and firm and place the motor-cycle on its stand.
- Switch off the ignition.



- Remove screw **1**.
- Pull the bulb housing forward to remove



- Disconnect plug **2**.

- Turn bulb holder **3** counter-clockwise to remove it from the bulb housing.

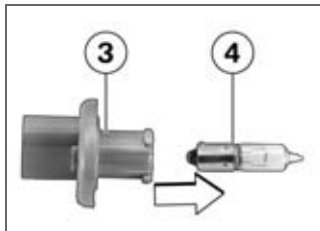

- Press bulb **4** into bulb socket **3** and remove by turning it anti-clockwise.
- Replace the defective bulb

 Bulbs for flashing turn indicators, front

- P21W / 12 V / 21 W

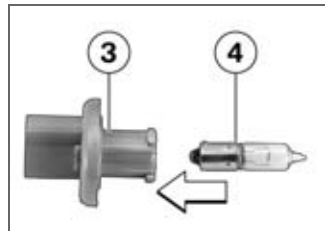

- Press bulb **4** into socket **3** and turn it clockwise to install.

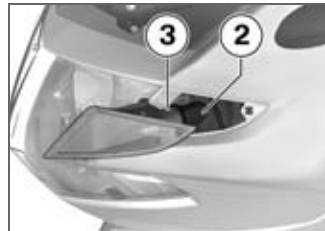

- Turn bulb socket **3** clockwise to install it in the bulb housing.
- Connect plug **2**.



- Seat the bulb housing in the fairing.
- Install screw **1**.

## Replacing brake-light, rear-light and rear-indicator bulbs

- Make sure the ground is level and firm and place the motorcycle on its stand.
- Switch off the ignition.



- Remove screws **1**.
- Pull the bulb housing to the rear until it is clear of the holders.



- Turn bulb socket **2** (indicator bulb) or bulb socket **3** (brake-light/rear-light bulb) anti-clock-

wise to remove it from the bulb housing.

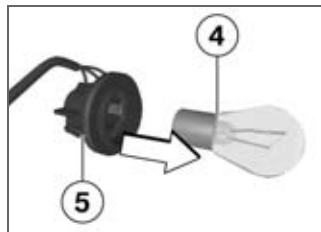

- Press bulb **4** into socket **5** and remove by turning it anti-clockwise.
- Replace the defective bulb.

 Bulb for tail light/brake light

– P21W / 12 V / 21 W

 Bulbs for flashing turn indicators, rear

– P21W / 12 V / 21 W

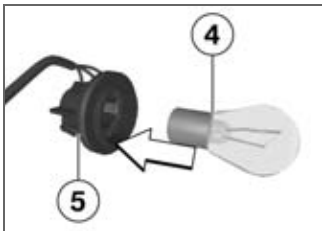

- Press bulb **4** into socket **5** and turn it clockwise to install.

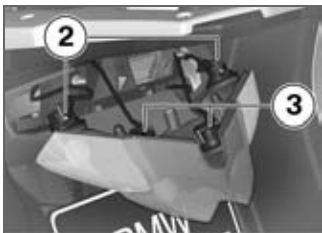

- Turn bulb socket **2** (indicator bulb) or bulb socket **3** (brake-light/rear-light bulb) clockwise to install it in the bulb housing.



- Seat the bulb housing in holders **6**. Make sure that the wires are not trapped.



- Install screws **1**.

## Jump starting

**⚠** The wires leading to the power socket do not have a load-capacity rating adequate for jump-starting the engine. Excessively high current can lead to a cable fire or damage to the vehicle electronics.

Do not use the on-board socket to jump-start the engine of the motorcycle. ◀

**⚠** Touching live parts of the ignition system with the engine running can cause electric shock.

Do not touch parts of the ignition system when the engine is running. ◀

**⚠** A short-circuit can result if the crocodile clips of the jump leads are accidentally brought into contact with the motorcycle.

Use only jump leads fitted with

fully insulated crocodile clips at both ends. ◀



Jump-starting with a donor-battery voltage higher than 12 V can damage the vehicle electronics.

Make sure that the battery of the donor vehicle has a voltage rating of 12 V. ◀

- When jump-starting the engine, do not disconnect the battery from the on-board electrical system.
- Remove the battery-compartment cover (⇒ 138).
- Run the engine of the donor vehicle during jump-starting.
- Begin by connecting one end of the red jump lead to the positive terminal of the discharged battery and the other end to the positive terminal of the donor battery.
- Then connect one end of the black jump lead to the negative

terminal of the donor battery, and the other end to the negative terminal of the discharged battery.

- Start the engine of the vehicle with the discharged battery in the usual way; if the engine does not start, wait a few minutes before repeating the attempt in order to protect the starter motor and the donor battery.
- Allow both engines to idle for a few minutes before disconnecting the jump leads.
- Disconnect the jump lead from the negative terminals first, then disconnect the second lead from the positive terminals.
- Installing battery-compartment cover (⇒ 138).

## Battery

### Maintenance instructions

Correct upkeep, recharging and storage will prolong the life of the battery and are essential if warranty claims are to be considered.

Compliance with the points below is important in order to maximise battery life:

- Keep the surface of the battery clean and dry
- Do not open the battery
- Do not top up with water
- Be sure to read and comply with the instructions for charging the battery on the following pages
- Do not turn the battery upside down



If the battery is not disconnected, the on-board electronics (e.g. clock, etc.) gradually drain the battery. This can cause the battery to run flat. If this hap-

pens, warranty claims will not be accepted.

If the motorcycle is to be out of use for more than four weeks, disconnect the battery or connect a suitable trickle charger to the battery. ◀

▶ BMW Motorrad has developed a float charger specially designed for compatibility with the electronics of your motorcycle. Using this charger, you can keep the battery charged during long periods of disuse, without having to disconnect the battery from the motorcycle's on-board systems. You can obtain additional information from your authorised BMW Motorrad dealer. ◀

## Charging battery when connected

⚠ Charging the connected battery directly at the battery terminals can damage the vehicle electronics.

Always disconnect the battery from the on-board circuits before recharging it with a charger connected directly to the battery posts. ◀

⚠ If you switch on the ignition and the multifunction display and telltale lights fail to light up, the battery is completely flat. Attempting to charge a completely flat battery via the on-board socket can cause damage to the motorcycle's electronics. If a battery has discharged to the extent that it is completely flat, it has to be disconnected from the on-board circuits and charged with the charger connected directly to the battery posts. ◀

⚠ Only chargers suitable for this mode of charging can be used to recharge the battery via the on-board socket. Unsuitable chargers could cause damage to the motorcycle's on-board electrics.

Use BMW chargers with the part numbers 71 60 7 688 864 (220 V) or, as applicable, 71 60 7 688 865 (110 V). If you are in doubt, disconnect the battery from the on-board systems and connect the charger directly to the battery. ◀

- Charge via the power socket, with the battery connected to the motorcycle's on-board electrical system.

▶ The motorcycle's on-board electronics know when the battery is fully charged. The on-board socket is switched off when this happens. ◀

- Comply with the operating instructions of the charger.

▶ If you are unable to charge the battery through the on-board socket, you may be using a charger that is not compatible with your motorcycle's electronics. If this happens, disconnect the battery from the on-board systems and connect the charger directly to the battery. ◀

## Charging battery when disconnected

- Charge the battery using a suitable charger.
- Comply with the operating instructions of the charger.
- Once the battery is fully charged, disconnect the charger's terminal clips from the battery terminals.

▶ The battery has to be recharged at regular intervals in the course of a lengthy period of disuse. See the instructions

for caring for your battery. Always fully recharge the battery before restoring it to use ◀

## Removing battery

- Remove the battery-compartment cover (➔ 138).

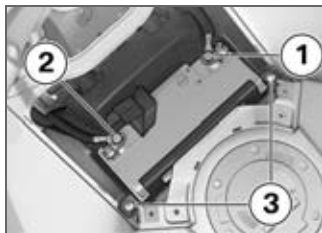

⚠ Disconnection in the wrong sequence increases the risk of short-circuits. Always proceed in the correct sequence. ◀

- Disconnect negative lead **1** first.

- Then disconnect positive lead **2**.
- Remove screws **3** and push retaining bracket to the rear.
- Lift the battery up and out; work it slightly back and forth if it is difficult to remove.

## Installing battery

- Place the battery in the battery compartment, positive terminal on the right in the forward direction of travel.

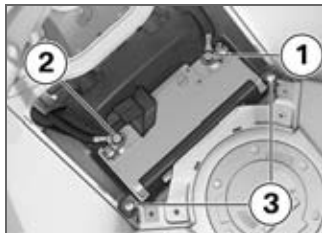

- Slip the battery retainer over the battery and install screws **3**.

**!** Installation in the wrong sequence increases the risk of short-circuits. Always proceed in the correct sequence. ◀

- Connect battery positive lead **2** first.
- The connect battery negative lead **1**.

**▷** If the battery was disconnected from the motorcycle for a prolonged period of time it will be necessary to enter the current date in the instrument panel, in order to ensure that the service-due indicator functions correctly.

If you want to have the date set consult a specialist workshop, preferably an authorised BMW Motorrad dealer. ◀

- Installing battery-compartment cover (➔ 138).
- Setting clock (➔ 53).

## Remove the battery-compartment cover

- Make sure the ground is level and firm and place the motor-cycle on its stand.



- Remove screws **1**.
- Lift the battery compartment cover up and back to remove.

## Installing battery-compartment cover



- Seat the battery-compartment cover in mounts **2** and close.

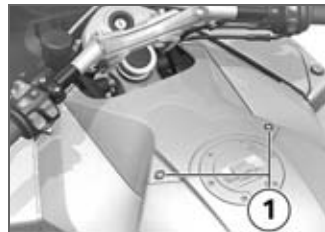

- Install screws **1**.

## Care

Care products .....	140
Washing motorcycle .....	140
Cleaning easily damaged components.....	140
Paint care .....	141
Protective wax coating .....	142
Laying up motorcycle .....	142
Restoring motorcycle to use .....	142

## Care products

BMW Motorrad recommends that you use the cleaning and care products you can obtain from your authorised BMW Motorrad dealer. The substances in BMW CareProducts have been tested in laboratories and in practice; they provide optimised care and protection for the materials used in your vehicle.

 The use of unsuitable cleaning and care products can damage vehicle components. Do not use solvents such as cellulose thinners, cold cleaners, fuel or the like, and do not use cleaning products that contain alcohol.◀

## Washing motorcycle

BMW Motorrad recommends that you use BMW insect remover to soften and wash off insects and stubborn dirt on

painted parts prior to washing the motorcycle.

To prevent stains, do not wash the motorcycle immediately after it has been exposed to strong sunlight and do not wash it in the sun.

Make sure that the motorcycle is washed frequently, especially during the winter months.

To remove road salt, clean the motorcycle with cold water immediately after every trip.

 After the motorcycle has been washed, ridden through water or ridden in the rain, the brake discs and pads might be wet and the brakes might not take effect immediately.

Apply the brakes in good time until the brakes have dried out.◀

 Warm water intensifies the effect of salt.

Use only cold water to wash off road salt.◀

 The high pressure of steam cleaners can damage seals, the hydraulic brake system, the electrical system, and the seat. Do not use a steam jet or high-pressure cleaning equipment.◀

## Cleaning easily damaged components

### Plastics

Clean plastic parts with water and BMW plastic care emulsion. This includes in particular:

- Windscreen and slipstream deflectors
- Headlight lens made of plastic
- Glass cover of the instrument cluster
- Black, unpainted parts

 If plastic parts are cleaned using unsuitable cleaning

agents, the surfaces can be damaged.

Do not use cleaning agents that contain alcohol, solvents or abrasives to clean plastic parts.

Even fly-remover pads or cleaning pads with hard surfaces can produce scratches. ◀

 Soften stubborn dirt and insects by covering the affected areas with a wet cloth. ◀

## Windscreen

Clean off dirt and insects with a soft sponge and plenty of water.

 Fuel and chemical solvents attack the material of the windscreen; the windscreen becomes opaque or dull.

Do not use cleaning agents. ◀

## Chrome

Use plenty of water and BMW shampoo to clean chrome, particularly if it has been exposed to road salt. Use chrome polish for additional treatment.

## Radiator

Clean the radiator regularly to prevent overheating of the engine due to inadequate cooling. For example, use a garden hose with low water pressure.

 Cooling fins can be bent easily.

Take care not to bend the fins when cleaning the radiator. ◀

## Rubber

Treat rubber components with water or BMW rubber-care products.

 Using silicone sprays for the care of rubber seals can cause damage.

Do not use silicone sprays or other care products that contain silicon. ◀

## Paint care

Washing the motorcycle regularly will help counteract the long-term effects of substances that damage the paint, especially if your motorcycle is ridden in areas with high air pollution or natural sources of dirt, for example tree resin or pollen.

Remove particularly aggressive substances immediately, however, as otherwise the paint can be affected or become discoloured. Substances of this nature include spilt fuel, oil, grease, brake fluid and bird droppings. We recommend BMW vehicle polish or BMW paint cleaner for this purpose.

Marks on the paintwork are particularly easy to see after the motorcycle has been washed.

Remove stains of this kind immediately, using cleaning-grade benzene or petroleum spirit on a clean cloth or ball of cotton wool. BMW Motorrad recommends BMW tar remover for removing specks of tar. Remember to wax the parts treated in this way.

## Protective wax coating

BMW Motorrad recommends applying only BMW car wax or products containing carnauba wax or synthetic wax.

It is time to rewax the paintwork when water "puddles" on the surface, instead of forming beads.

## Laying up motorcycle

- Clean the motorcycle.
- Remove the battery.
- Spray the brake and clutch lever pivots and the main and

side stand pivots with a suitable lubricant.

- Coat bright metal and chrome-plated parts with an acid-free grease (e.g. Vaseline).
- Stand the motorcycle in a dry room in such a way that there is no load on either wheel.

▶ Before laying the vehicle up out of use, have the engine oil and the oil filter element changed by a specialist workshop, preferably an authorised BMW Motorrad dealer. Combine work for laying up/restoring to use with a BMW service or inspection.◀

## Restoring motorcycle to use

- Remove the protective wax coating.
- Clean the motorcycle.
- Install a charged battery.

- Before starting: work through the checklist.

## Technical data

Troubleshooting chart .....	144
Threaded fasteners .....	145
Engine .....	147
Fuel .....	148
Engine oil .....	148
Clutch .....	149
Transmission .....	149
Rear-wheel drive .....	150
Running gear .....	150
Brakes .....	152
Wheels and tyres .....	152
Electrics .....	153
Frame .....	154
Dimensions .....	155
Weights .....	155

Riding specifications .....	156
-----------------------------	-----

## Troubleshooting chart

Engine does not start at all or is difficult to start.

<b>Possible cause</b>	<b>Remedy</b>
Side stand	Retract the side stand (➔ 84).
Gear engaged and clutch not disengaged	Select neutral or pull clutch lever (➔ 84).
Clutch pulled before ignition was switched on	Switch on the ignition, then pull the clutch lever.
No fuel in tank	Refuelling (➔ 90).
Battery flat	Charge the battery when connected (➔ 136).

## Threaded fasteners

Front wheel	Value	Valid
<b>Front brake caliper to wheel carrier</b>		
M8 x 32 - 10.9	30 Nm	
<b>Clamping bolt in wheel carrier</b>		
M8 x 30	19 Nm	
<b>Quick-release axle in threaded bush</b>		
M24 x 1.5	50 Nm	
<b>Rear wheel</b>	<b>Value</b>	<b>Valid</b>
<b>Silencer to rear footrest</b>		
M8 x 30	22 Nm	
<b>Silencer with ball-joint clamp on manifold</b>		
M8 x 60	35 Nm	
<b>Cover to silencer</b>		
M5 x 8	3 Nm	

<b>Rear wheel</b>	<b>Value</b>	<b>Valid</b>
<b>Rear wheel to wheel flange</b>		
M10 x 1.25 x 40	<b>tighten in diagonally opposite sequence</b>	
	60 Nm	
<b>Handlebars</b>	<b>Value</b>	<b>Valid</b>
<b>Handlebar adjustment screws on threaded bushes</b>		
M8 x 45	20 Nm	

## Engine

Engine design	Transversely mounted, four-cylinder four-stroke in-line engine tilted 55° forward, with four valves per cylinder, two overhead camshafts with cam followers; liquid cooled, with electronic fuel injection, integrated six-speed cassette gearbox, dry-sump lubrication.
Displacement	1293 cm <sup>3</sup>
Cylinder bore	80 mm
Piston stroke	64.3 mm
Compression ratio	13:1
Nominal output	118 kW, - at engine speed: 9000 min <sup>-1</sup>
- with reduced power output, 79 kW <sup>OE</sup>	79 kW, - at engine speed: 9000 min <sup>-1</sup>
Torque	135 Nm, - at engine speed: 8000 min <sup>-1</sup>
- with reduced power output, 79 kW <sup>OE</sup>	118 Nm, Over: 3750 min <sup>-1</sup>
Maximum engine speed	max 11000 min <sup>-1</sup>
Idle speed	1050±50 min <sup>-1</sup>

## Fuel

Recommended fuel grade	98 ROZ/RON, Premium plus unleaded 95 ROZ/RON, Premium unleaded (fuel grade, usable with power- and consumption-related restrictions)
Usable fuel capacity	approx. 24 l
Reserve fuel	≥4 l

## Engine oil

Engine oil, capacity	3.5 l, with filter change 0.5 l, Difference between MIN / MAX marks
Engine oils, products recommended by BMW Motorrad and generally permitted viscosity classes	
Castrol Power 1 Racing SAE 5W-40	≥-20 °C
SAE 5W-40	≥-20 °C
SAE 10W-50	≥-20 °C
Oil grades	Engine oils of API classification SJ or better. Engine oils of JASO classification MA or better.

## Clutch

Clutch type	Multiplate clutch running in oil bath
-------------	---------------------------------------

## Transmission

Gearbox type	Claw-shift 6-speed gearbox, integrated into engine block
Gearbox transmission ratios	1.559 (92:59 teeth), Primary transmission ratio 2.294 (39:17 teeth), 1st gear 1.789 (34:19 teeth), 2nd gear 1.458 (35:24 teeth), 3rd gear 1.240 (31:25 teeth), 4th gear 1.094 (35:32 teeth), 5th gear 0.971 (33:34 teeth), 6th gear 1.045 (23:22 teeth), Angular drive

## Rear-wheel drive

Type of final drive	Shaft drive with bevel gears
Type of rear suspension	BMW EVO Paralever; cast light-alloy single swinging arm with two joints and torque reaction link
Number of teeth on rear-wheel drive (gear ratio)	2.82 (31:11)

## Running gear

### Front wheel

Type of front suspension	Double leading link
Spring strut, front, type	Central spring strut with coil spring and single-tube gas-filled shock absorber.
– with Electronic Suspension Adjustment (ESA II) <sup>OE</sup>	Central spring strut with single-tube gas-filled shock absorber and electrically adjustable rebound-stage damping.
Spring travel, front	125 mm, At wheel

**Rear wheel**

Type of rear suspension	BMW EVO Paralever; cast light-alloy single swinging arm with two joints and torque reaction link
Type of rear suspension	Central spring strut pivoted to lever system with coil spring and single-tube gas-filled shock absorber. Spring preload steplessly hydraulically adjustable, rebound stage damping steplessly adjustable.
– with Electronic Suspension Adjustment (ESA II) <sup>OE</sup>	Central spring strut pivoted to lever system with coil spring and single-tube gas-filled shock absorber, electrically adjustable rebound-stage damping and electro-hydraulically adjustable spring preload
Spring travel, rear	135 mm, At wheel

## Brakes

Type of front brake	Hydraulically operated twin disc brake with 4-piston fixed calipers and floating brake discs
Brake-pad material, front	Sintered metal
Type of rear brake	Hydraulically operated disc brake with 2-piston floating caliper and fixed disc
Brake-pad material, rear	Organic material

## Wheels and tyres

Recommended tyre sets	You can obtain an up-to-date list of approved tyres from your authorised BMW Motorrad dealer or on the Internet at " <a href="http://www.bmw-motorrad.com">www.bmw-motorrad.com</a> ".
-----------------------	--

### Front wheel

Front wheel, type	Cast aluminium, MT H2
Front wheel rim size	3.50" x 17"
Tyre designation, front	120 / 70 ZR 17

### Rear wheel

Rear wheel type	Cast aluminium, MT H2
Rear wheel rim size	5.5" x 17"
Tyre designation, rear	180 / 55 ZR 17

**Tyre pressure**

Tyre pressure, front	2.5 bar, one-up, tyre cold 2.5 bar, two-up and/or with luggage, tyre cold
Tyre pressure, rear	2.9 bar, one-up, tyre cold 2.9 bar, two-up and/or with luggage, tyre cold

**Electrics**

Electrical rating of on-board socket	max 8 A
Fuses	All circuits are electronically protected, so plug-in fuses are no longer necessary. If an electronic fuse trips and de-energises a circuit, the circuit is active as soon as the ignition is switched on after the fault has been rectified.

**Battery**

Battery, manufacturer and designation	19Ah Gel Exide
Battery type	Gel battery
Battery rated voltage	12 V
Battery rated capacity	19 Ah

**Technical data**

Spark plugs, manufacturer and designation	NGK KR9CI
Electrode gap of spark plug	0.8 mm, When new

**Lighting**

Bulb for high-beam headlight	H7 / 12 V / 55 W
Bulbs for the low-beam headlight	H7 / 12 V / 55 W
– with Xenon light <sup>OE</sup>	D1R / 35 W
Bulb for parking light	W5W / 12 V / 5 W
Bulb for tail light/brake light	P21W / 12 V / 21 W
Bulbs for flashing turn indicators, front	P21W / 12 V / 21 W
Bulbs for flashing turn indicators, rear	P21W / 12 V / 21 W

**Frame**

Frame type	Light alloy weldment with bolt-on tubular steel rear frame
Type plate location	Frame cross-tube, rear
VIN location	Frame side section, front right

## Dimensions

Length of motorcycle	2318 mm
Height of motorcycle	1438 mm, To windscreen at DIN unladen weight
Width of motorcycle	982 mm, Across cases
Front-seat height	820...840 mm, Without rider
– with low seat <sup>OE</sup>	800...820 mm, Without rider
Rider's inside-leg arc, heel to heel	1800...1840 mm, Without rider
– with low seat <sup>OE</sup>	1760...1800 mm, Without rider

## Weights

Unladen weight	288 kg, DIN unladen weight, ready for road, 90 % load of fuel, without optional extras
Permissible gross weight	520 kg
Maximum payload	232 kg

## Riding specifications

Top speed	>200 km/h
-----------	-----------

## Service

BMW Motorrad service .....	158
BMW Motorrad service quality .....	158
BMW Motorrad Service Card: on-the-spot breakdown assistance ....	158
BMW Motorrad service network .....	159
Maintenance work .....	159
Confirmation of maintenance work .....	160
Confirmation of service .....	165

## BMW Motorrad service

Advanced technology requires specially adapted methods of maintenance and repair.



If maintenance and repair work is performed inexpertly, it could result in consequential damage and thus constitute a safety risk.

BMW Motorrad recommends you to have all the associated work on your motorcycle carried out by a specialist workshop, preferably an authorised BMW Motorrad dealer. ◀

Your authorised BMW Motorrad dealer can provide information on BMW services and the work undertaken as part of each service. Have all maintenance and repair work carried out confirmed in the "Service" chapter in this manual. Authorised BMW Motorrad dealers are supplied with the latest technical information and have

the necessary technical know-how. BMW Motorrad recommends that you contact your authorised BMW Motorrad dealer if you have questions regarding your motorcycle.

## BMW Motorrad service quality

Along with its reputation for engineering quality and high reliability, BMW Motorrad is a byword for excellent quality of service. To ensure that your BMW is always in optimum condition, BMW Motorrad recommends that you have the maintenance work required for your motorcycle carried out regularly, preferably by your authorised BMW Motorrad dealer. For generous treatment of claims submitted after the warranty period has expired, evidence of regular maintenance is essential.

Certain signs of wear, moreover, may otherwise not be noticed until it is too late to put them right at moderate cost. Your authorised BMW Motorrad dealer's mechanics know every detail of your motorcycle and can take remedial action if necessary before minor faults develop into serious problems. By having the necessary repairs done properly and in good time, you save time and money in the long run.

## BMW Motorrad Service Card: on-the-spot breakdown assistance

In the event of a breakdown, the BMW Motorrad Service Card issued with each new BMW motorcycle enables you to access an extensive range of services such as breakdown assistance, motorcycle transportation etc. (details can differ from country to country). In the event of a break-

down, contact the Mobile Service organisation of BMW Motorrad. The specialists will provide the necessary advice and assistance. You will find important country-specific contact addresses and the after-sales service organisation phone numbers in the "Service Kontakt / Service Contact" brochures, along with information on Mobile Service and the dealership network.

## **BMW Motorrad service network**

BMW Motorrad has an extensive after-sales service network in place to look after you and your motorcycle in more than 100 countries. In Germany alone, you have the best possible access to approximately 200 authorised BMW Motorrad dealers.

All information concerning the international dealership network can be found in the brochure

"Service Contact Europe" or "Service Contact Africa, America, Asia, Australia, Oceania".

## **Maintenance work**

### **BMW Pre-delivery Check**

Your authorised BMW Motorrad dealer conducts the BMW pre-delivery check before handing over the motorcycle to you.

### **BMW Running-in Check**

The BMW running-in check has to be performed when the motorcycle has covered between 500 km and 1,200 km

### **BMW Service**

The BMW Service is carried out once a year; the extent of servicing can vary, depending on the age of the motorcycle and the distance it has covered. Your authorised BMW Motorrad dealer confirms that the service work has been carried out and enters

the date when the next service will be due.

Riders who cover long distances in a year might have to bring in their motorcycles for service before the next scheduled date. It is to allow for these cases that a maximum odometer reading is entered as well in the confirmation of service. Servicing has to be brought forward if this odometer reading is reached before the next scheduled date for the annual service.

The service-due indicator in the multifunction display reminds you about one month or 1000 km in advance when the time for a service is approaching, on the basis of the programmed values.

## Confirmation of maintenance work

### BMW Pre-delivery Check

Completed

on \_\_\_\_\_

\_\_\_\_\_  
Stamp, signature

### BMW Running-in Check

Completed

on \_\_\_\_\_

Odometer reading \_\_\_\_\_

Next service  
at the latest

on \_\_\_\_\_

or, if logged beforehand,

Odometer reading \_\_\_\_\_

\_\_\_\_\_  
Stamp, signature

**BMW Service**

Completed

on \_\_\_\_\_

Odometer reading \_\_\_\_\_

Next service  
at the latest

on \_\_\_\_\_

or, if logged beforehand,

Odometer reading \_\_\_\_\_

\_\_\_\_\_  
Stamp, signature**BMW Service**

Completed

on \_\_\_\_\_

Odometer reading \_\_\_\_\_

Next service  
at the latest

on \_\_\_\_\_

or, if logged beforehand,

Odometer reading \_\_\_\_\_

\_\_\_\_\_  
Stamp, signature**BMW Service**

Completed

on \_\_\_\_\_

Odometer reading \_\_\_\_\_

Next service  
at the latest

on \_\_\_\_\_

or, if logged beforehand,

Odometer reading \_\_\_\_\_

\_\_\_\_\_  
Stamp, signature

**BMW Service**

Completed

on \_\_\_\_\_

Odometer reading \_\_\_\_\_

Next service  
at the latest

on \_\_\_\_\_

or, if logged beforehand,

Odometer reading \_\_\_\_\_

\_\_\_\_\_  
Stamp, signature**BMW Service**

Completed

on \_\_\_\_\_

Odometer reading \_\_\_\_\_

Next service  
at the latest

on \_\_\_\_\_

or, if logged beforehand,

Odometer reading \_\_\_\_\_

\_\_\_\_\_  
Stamp, signature**BMW Service**

Completed

on \_\_\_\_\_

Odometer reading \_\_\_\_\_

Next service  
at the latest

on \_\_\_\_\_

or, if logged beforehand,

Odometer reading \_\_\_\_\_

\_\_\_\_\_  
Stamp, signature

**BMW Service**

Completed

on \_\_\_\_\_

Odometer reading \_\_\_\_\_

Next service  
at the latest

on \_\_\_\_\_

or, if logged beforehand,

Odometer reading \_\_\_\_\_

\_\_\_\_\_  
Stamp, signature**BMW Service**

Completed

on \_\_\_\_\_

Odometer reading \_\_\_\_\_

Next service  
at the latest

on \_\_\_\_\_

or, if logged beforehand,

Odometer reading \_\_\_\_\_

\_\_\_\_\_  
Stamp, signature**BMW Service**

Completed

on \_\_\_\_\_

Odometer reading \_\_\_\_\_

Next service  
at the latest

on \_\_\_\_\_

or, if logged beforehand,

Odometer reading \_\_\_\_\_

\_\_\_\_\_  
Stamp, signature

**BMW Service**

Completed

on \_\_\_\_\_

Odometer reading \_\_\_\_\_

Next service  
at the latest

on \_\_\_\_\_

or, if logged beforehand,

Odometer reading \_\_\_\_\_

\_\_\_\_\_  
Stamp, signature**BMW Service**

Completed

on \_\_\_\_\_

Odometer reading \_\_\_\_\_

Next service  
at the latest

on \_\_\_\_\_

or, if logged beforehand,

Odometer reading \_\_\_\_\_

\_\_\_\_\_  
Stamp, signature**BMW Service**

Completed

on \_\_\_\_\_

Odometer reading \_\_\_\_\_

Next service  
at the latest

on \_\_\_\_\_

or, if logged beforehand,

Odometer reading \_\_\_\_\_

\_\_\_\_\_  
Stamp, signature

## Confirmation of service

The table is intended as a record of maintenance and repair work, the installation of optional accessories and, if appropriate, special campaign (recall) work.

Item	Odometer reading	Date



## A

Abbreviations and symbols, 6

### ABS

Engineering details, 94

Self-diagnosis, 85

Warnings, 36

### Anti-theft alarm

Telltale light, 20

Warnings, 45

### ASC

Control, 14

Engineering details, 96

Operation, 65

Self-diagnosis, 86

Switching off, 65

Switching on, 66

Warning, 40

Warnings, 38

## B

### Battery

Charging battery when connected, 136

Charging battery when disconnected, 137

Closing the battery-compartment, 138

Installation, 137

Opening the battery-compartment, 138

Removal, 137

Stowage, 13

Technical data, 153

Warning for battery charge current, 33

### BMW Motorrad Service

Card, 158

### Brake fluid

Checking fluid levels, 115

Reservoir, front, 13

Reservoir, rear, 19

### Brake pads

Checking brake-pad thickness, 113

Running in, 87

### Brakes

Adjusting brake lever, 70

Checking operation, 113

Safety instructions, 87

Technical data, 152

## Bulbs

General instructions, 128

Overview, headlights, 22

Replace xenon bulb, 128

Replacing brake-light bulb, 133

Replacing front turn indicator bulbs, 131

Replacing high-beam headlight bulb, 129

Replacing low-beam headlight bulb, 129

Replacing parking-light bulb, 130

Replacing rear light bulb, 133

Replacing rear-indicator bulbs, 133

Technical data, 154

Warning for bulb failure, 33, 34

## C

### Case

Operation, 104

### Checklist, 84

### Clock, 24

Adjusting, 53

**C**

- Clutch
  - Adjusting clutch lever, 69
  - Checking fluid level, 117
  - Checking operation, 117
  - Fluid reservoir, 11
  - Technical data, 149
- Confirmation of maintenance work, 160
- Coolant
  - Temperature gauge, 24
  - Warning, 31
- Cruise-control system
  - Control, 14
  - Operation, 66
  - Telltale light, 20, 27
- Currency, 7

**D**

- Damping
  - Adjuster, rear, 11
  - Adjusting, 72
- Dimensions
  - Technical data, 155

**E**

- Electrics
  - Technical data, 153
- Electronic immobiliser (EWS)
  - Warning, 31
- Emergency off switch (kill switch), 16, 62
- Engine
  - Control, 16
  - Starting, 84
  - Technical data, 147
  - Temperature gauge, 24
  - Warning for engine electronics, 32
- Engine oil
  - Checking level, 111
  - Filler neck, 19
  - Oil dipstick, 19
  - Technical data, 148
  - Topping up, 112
  - Warning for engine oil level, 36
  - Warning for engine oil pressure, 32
- Equipment, 7

**ESA**

- Control, 14
- Engineering details, 99
- Operation, 73

**F**

- Frame
    - Technical data, 154
  - Front seat
    - Height adjuster, 19
  - Front-wheel stand
    - Installing, 127
  - Fuel
    - Fill-level indicator, 24
    - Filler neck, 13
    - Refuelling, 90
    - Technical data, 148
    - Warning for fuel down to reserve, 31
  - Fuses, 153
- G**
- Gear indicator, 24
  - General views
    - Headlight, 22
    - Instrument cluster, 20

- Left handlebar fitting, 14
  - Left side of motorcycle, 11
  - Multifunction display, 24
  - Right handlebar fitting, 16
  - Right side of motorcycle, 13
  - Underneath the seat, 19
- Grip heating, 62
- Control, 16

## H

- Handlebar fittings
  - General view, left side, 14
  - General view, right side, 16
- Handlebars
  - Adjusting, 71
- Hazard warning flashers
  - Control, 14
  - Operation, 61

- Headlight
    - Adjustment for driving on left/  
driving on right, 75
    - Beam throw, 76
    - Headlight beam-throw  
adjustment, 11
    - Overview, 22
  - Helmet holder, 19, 79
  - High-beam headlight
    - Switching on, 60
    - Telltale light, 24
  - Horn, 14
- ## I
- Idle
    - Telltale light, 24
  - Ignition
    - Switching off, 51
    - Switching on, 51
  - Immobiliser, 52
    - Warning, 31
  - Instrument cluster
    - Ambient-light brightness  
sensor, 20
    - Overview, 20

## J

- Jump starting, 134

## K

- Keys, 51

## L

- Laying up, 142
- Lights
  - Control, 14
  - Headlight flasher, 14, 60
  - High-beam headlight, 14
  - Switching on low-beam  
headlight, 60
  - Switching on parking lights, 60
  - Switching on the high-beam  
headlight, 60
  - Switching on the side lights, 59
- Luggage
  - Instructions for loading and  
securing objects, 103

## M

- Maintenance
  - General instructions, 110
- Maintenance intervals, 159

**Mirrors**

Adjusting, 71

**Motorcycle**

Laying up, 142

Parking, 89

Restoring to use, 142

**Multifunction display, 20**

Adjust the dimmer, 55

Overview, 24

**O****Odometer and tripmeters, 24**

Control, 14

Operation, 53

Resetting, 54

Selecting readings, 53

**On-board computer**

Ambient temperature, 56

Average consumption, 57

Average speed, 57

Control, 14

Oil level, 58

Operation, 55

Range, 56

Warnings, 34

**P**

Parking, 89

Parking light

Switching on, 60

Power socket, 11, 102

Pre-ride check, 85

**R**

Rear-wheel drive

Technical data, 150

Refuelling, 90

Reserve volume

Warning, 31

Residual range, 55

Restoring to use, 142

Rev. counter, 20

Rider's Manual

Stowage, 19

Running gear

Technical data, 150

Running in, 87

**S**

Safety instructions

Brakes, 87

General, 82

**Seat**

Adjusting seat height, 69

Lock, 11

Seat heating, 63

Control, 16, 19

**Seats**

Installing front seat, 78

Installing rear seat, 79

Remove the front seat, 78

Remove the rear seat, 77

Service, 158

Service Card, 158

Service-due indicator, 24

**Side stand**

For starting, 84

Spark plugs, 153

Speedometer, 20

Spring preload

Adjuster, rear, 11

Adjusting, 71

Starting, 84

Status indicators

See also warnings, 24

Standard status indicators, 24

Warnings, 27

Steering lock  
  Locking, 52  
Storage compartment, 13  
Stowage compartment, 77

## **T**

Technical data  
  Battery, 153  
  Brakes, 152  
  Bulbs, 154  
  Clutch, 149  
  Dimensions, 155  
  Electrics, 153  
  Engine, 147  
  Engine oil, 148  
  Frame, 154  
  Fuel, 148  
  Rear-wheel drive, 150  
  Running gear, 150  
  Spark plugs, 153  
  Standards, 7  
  Transmission, 149  
  Weights, 155  
  Wheels and tyres, 152

Telltale lights, 20  
  Overview, 24

Toolkit  
  Contents, 110  
  Stowage, 19

Topcase  
  Closing, 106  
  Installing, 107  
  Opening, 106  
  Operation, 106  
  Removing, 107

Torques, 145

Transmission  
  For starting, 84  
  Technical data, 149

Transportation  
  Lashing, 92

Troubleshooting chart, 144

Turn indicators  
  Control, 14  
  Operation, 61  
  Telltale light, 24

Type plate, 13

Tyre pressure monitoring RDC  
  Adhesive label for rim, 119  
  Engineering details, 98  
  Operation, 59  
  Warnings, 40

## **Tyres**

  Checking inflation pressure, 75  
  Checking tread depth, 118  
  Recommendation, 118  
  Running in, 87  
  Table of tyre pressures, 19  
  Technical data, 152

## **V**

Vehicle identification number, 13

## **W**

Warning lights, 20

Warnings, 27  
  Mode of presentation, 27  
  With ABS, 36  
  With anti-theft alarm, 45  
  With ASC, 38  
  With on-board computer, 34

- With RDC, 40
- Warnings, overview, 29, 35, 37, 39, 42, 46
- Weights
  - Payload table, 19
  - Technical data, 155
- Wheels
  - Change of size, 119
  - Checking rims, 118
  - Installing front wheel, 121
  - Installing rear wheel, 125
  - Remove the front wheel, 119
  - Removing rear wheel, 123
  - Technical data, 152
- Windscreen
  - Adjusting, 69
  - Control, 14

Details described or illustrated in this booklet may differ from the motorcycle's actual specification as purchased, the accessories fitted or the national-market specification. No claims will be entertained as a result of such discrepancies.

Dimensions, weights, fuel consumption and performance data are quoted to the customary tolerances.

The right to modify designs, equipment and accessories is reserved.

Errors and omissions excepted.

© 2008 BMW Motorrad

Not to be reproduced either wholly or in part without written permission from BMW Motorrad, After Sales.

Printed in Germany.

The most important data for a filling-station stop can be found in the following chart:

<b>Fuel</b>	
Recommended fuel grade	98 ROZ/RON, Premium plus unleaded 95 ROZ/RON, Premium unleaded (fuel grade, usable with power- and consumption-related restrictions)
Usable fuel capacity	approx. 24 l
Reserve fuel	≥4 l
<b>Tyre pressure</b>	
Tyre pressure, front	2.5 bar, one-up, tyre cold 2.5 bar, two-up and/or with luggage, tyre cold
Tyre pressure, rear	2.9 bar, one-up, tyre cold 2.9 bar, two-up and/or with luggage, tyre cold

**BMW recommends** 

Order No.: 01 41 7 714 561  
10.2008, 1st edition



## K 1300 S, K 1300 R, K 1300 GT



D



Möglicher Bremsleistungsverlust an der Vorderradbremse.

Nach allen Arbeiten, die Einfluss auf den Flüssigkeitsstand im vorderen Bremskreislauf haben (z. B. Bremsbeläge erneuern oder Bremsflüssigkeit wechseln), muss der Gittereinsatz **1** im vorderen Ausgleichsbehälter für Bremsflüssigkeit erneuert werden. Wenden Sie sich dazu an eine Fachwerkstatt, am besten an einen BMW Motorrad Partner.

GB



Possible loss of stopping power at front brake.

Screen insert **1** in the front brake-fluid reservoir always has to be replaced on completion of work that affects the level of fluid in the front braking circuit (for example replacing brake pads or changing brake fluid). Please contact a specialized workshop for this purpose, preferably an authorized BMW Motorrad retailer.

USA

F



Perte possible d'efficacité du frein avant. Après des travaux qui influent sur le niveau de liquide de frein dans le circuit de frein avant (p. ex. remplacement des plaquettes ou renouvellement du liquide de frein), il est impératif de remplacer la grille **1** à l'intérieur du réservoir de liquide de frein avant. Adressez-vous pour cela à un atelier spécialisé, de préférence à un concessionnaire BMW Motorrad.



Posible pérdida de la capacidad de frenado en el freno de la rueda delantera. Una vez finalizados todos los trabajos que influyen en el nivel de líquido del circuito de freno delantero (p. ej., cambio de las pastillas de freno o del líquido de frenos), se tiene que sustituir la rejilla **1** del depósito de compensación delantero para el líquido de frenos. Para ello, póngase en contacto con un taller especializado, preferentemente un concesionario de motocicletas BMW.



Possibile diminuzione dell'effetto frenante del freno della ruota anteriore. Dopo aver eseguito tutti i lavori che comportano delle variazioni nel livello del liquido nel circuito freni anteriore (ad es. sostituzione delle pastiglie o del liquido freni), occorre sostituire l'inserto **1** nel serbatoio di espansione del liquido freni. Rivolgersi a tal fine ad un'officina autorizzata, preferibilmente ad un Concessionario BMW Motorrad.



Framhjulsbromsens bromseffekt kan försämräs. Efter alla arbeten som påverkar vätskenivån i den främre bromskretsen (t.ex. byte av bromsbelägg eller hydraulvätska) måste gallerinsats **1** i det främre expansionskärlet för hydraulvätska bytas ut. Kontakta en fackverkstad för detta, företrädesvis en BMW Motorrad-partner.



Mogelijk verlies van remvermogen van de voorrem. Na alle reparaties, die invloed kunnen hebben op het remvloeistofpeil in het voorremcircuit (bijv. remblokken vervangen of remvloeistof verversen), moet het rasterelement **1** in het voorste remvloeistofreservoir worden vervangen. Hiervoor contact opnemen met een specialist, bij voorkeur een BMW Motorrad dealer.

P



Possível perda de eficácia de travagem no travão dianteiro. Depois de se efectuarem todos os trabalhos que têm influência sobre o nível do líquido no circuito de travão dianteiro (p. ex., substituir pastilhas de travão ou mudar o óleo dos travões), é necessário substituir a grelha **1** no depósito de compensação dianteiro para o óleo dos travões. Para o efeito, dirija-se a uma oficina especializada, de preferência a um concessionário BMW Motorrad.

FIN



Etujarrun jarrutusteho saattaa olla heikentynyt. Aina sellaisen töiden jälkeen, joilla on vaikutusta etujarrupiiriin jarrunestemäärään (esimerkiksi jarrupalojen tai jarrunesteen vaihto), täytyy jarrunesteen etumaisen tasaussäiliön ritilä **1** vaihtaa. Käänny tässä asiassa ammattitaitoisen huoltopisteen, mieluiten BMW Motorrad huoltopisteen puoleen.

GR



Πιθανή απώλεια ιζ σύορ θπέων ζ ηρ θπένο μπποζ ηνού ηησοού. Μερά ηην ππαγμαρποίηζη επαζών, οι οποίοερ επηπαάζοζ ηη ζ ήάμη ηρς ζγπού ζ ηρ μπποζ ηνό κύκλωμα θπέων (π.σ. ανηκαράζ ηαζ η ηρακιών θπέων ή αλλαγή ζγπού θπέων), ππέπει να ανηκαράζ ηαθεί ηρ ζ ηραιοίε πλέγμαηηρ **1** ζ ηρ μπποζ ηνό δοοοείο ζγπών θπέων. Απερθς ηνθείηε για ηρ ζ κοπό ας ηρ ζ ε ένα εξειδικεζμένο ζ ζνεπηγείο ή ακόμη καλύηηα ζ ε έναν Επίζ ημο Επίζ κεζαζ ηη BMW Motorrad.

J



フロントブレーキの制動力損失のおそれ。  
フロントブレーキに対して、パッド交換やフルード交換など、サーキット内のフルードレベルに影響する作業を行った場合には、必ずフロントブレーキフルードリザーバータンク内のスクリーンインサート **1** を交換してください。交換の詳細については専門の整備工場が、可能な限り BMW Motorrad 正規ディーラーにお問い合わせください。

(SLO)



Možna izguba zavorne moči na zavori za sprednje kolo. Po vseh delih, ki vplivajo na nivo zavorne količine v sprednjem zavornem krogotoku (npr. menjava zavornih ploščic ali menjava zavorne tekočine), je treba zamenjati mrežasti vložek **1** v sprednji izenačevalni posodi za zavorno tekočino. V zvezi s tem se obrnite na specializirano servisno delavnico, najbolje na partnerja BMW Motorrad.

(SK)



Možná strata brzdného výkonu na brzde predného kolesa. Po skončení všetkých prác, ktoré majú vliv na stav kapaliny v predním brzdovém okruhu (např. výměna brzdového obložení nebo brzdové kapaliny), musí být vyměněna mřížková vložka 1 v přední expanzní nádobce brzdové kapaliny. V této souvislosti se obraťte na odbornou dílnu, nejlepšíe na niektorého partnera BMW Motorrad.

(CZ)



Možná ztráta brzdného účinku brzdy předního kola. Po skončení všech prací, které mají vliv na stav kapaliny v předním brzdovém okruhu (např. výměna brzdového obložení nebo brzdové kapaliny), musí být vyměněna mřížková vložka 1 v přední expanzní nádobce brzdové kapaliny. Obrat'te se na odborný servis, nejlépe na partnera BMW Motorrad.

