



**BMW
MOTORRAD**

RIDER'S MANUAL

F 900 R



MAKE LIFE A RIDE

Vehicle data

Model

Vehicle Identification Number

Colour code

Date of first registration

Registration number

Dealership details

Person to contact in Service department

Ms/Mr

Phone number

Dealership address/phone number (company stamp)

YOUR BMW.

We congratulate you on your choice of a vehicle from BMW Motorrad and welcome you to the community of BMW riders. Familiarise yourself with your new vehicle so that you can ride it safely and confidently in all traffic situations.

About this rider's manual

Read this rider's manual carefully before starting to use your new BMW. It contains important information on how to operate the controls and how to make the best possible use of all your BMW's technical features.

In addition, it contains information on maintenance and care to help you maintain your vehicle's reliability and safety, as well as its value.

If the time comes to sell your BMW, please remember to hand over this rider's manual to the new owner. It is an important part of the vehicle.

We hope you will enjoy riding your BMW and that all your journeys will be pleasant and safe

BMW Motorrad.

01 GENERAL INSTRUCTIONS	2	03 STATUS INDICATORS	26
Overview	4	Indicator and warning lights	28
Abbreviations and symbols	4	TFT display in Pure Ride view	29
Equipment	5	TFT display in Menu view	30
Technical data	5	TFT display in Sport 1 view	31
Currency	6	TFT display in Sport 2 view	32
Additional sources of information	6	Warning indicators	33
Certificates and operating licences	6		
Data memory	6		
Intelligent emergency call system	11	04 OPERATION	60
02 GENERAL VIEWS	16	Ignition switch/steering lock	62
General view, left side	18	Ignition with Keyless Ride	63
General view, right side	19	Electronic immobiliser EWS	67
Underneath the seat	20	Emergency-off switch (kill switch)	68
Multifunction switch, left	21	Intelligent emergency call	68
Multifunction switch, right	22	Lights	71
Multifunction switch, right	23	Daytime riding light	72
Instrument cluster	24	Hazard warning lights	74
		Turn indicators	74
		Traction control (ASC/DTC)	75
		Electronic Suspension Adjustment (D-ESA)	77
		Riding mode	79
		Riding mode PRO	81
		Cruise control	82

Laptimer	84	07 RIDING	124
Shift light	86	Safety information	126
Anti-theft alarm (DWA)	86	Regular check	129
Tyre pressure control (RDC)	89	Starting	130
Heated grips	90	Running in	134
Seat	90	Shifting gear	135
		Shift light	136
		Brakes	136
05 TFT DISPLAY	92	Parking your motorcycle	138
General notes	94	Refuelling	139
Principle	95	Securing motorcycle for transportation	144
Pure Ride view	101		
General settings	102	08 ENGINEERING DETAILS	146
Bluetooth	104	General notes	148
My vehicle	107	Antilock Brake System (ABS)	148
On-board computer	110	Traction control (ASC/DTC)	151
Navigation	110	Dynamic engine brake control	153
Media	112	Dynamic ESA	154
Telephone	113	Riding mode	154
Display software version	114	Dynamic Brake Control	156
Display licence information	114	Tyre pressure control (RDC)	157
		Gear Shift Assistant	159
06 ADJUSTMENT	116	Adaptive Headlight	160
Mirrors	118		
Headlight	118		
Clutch	119		
Brakes	120		
Spring preload	120		
Damping	121		

09 MAINTENANCE	162	Laying up motorcycle	215
General notes	164	Restoring motorcycle to use	215
Toolkit	165		
Service tool kit	165		
Front-wheel stand	165	12 TECHNICAL DATA	216
Rear-wheel stand	166	Troubleshooting chart	218
Engine oil	167	Threaded fasteners	220
Brake system	169	Fuel F 900 R (0K11)	221
Clutch	173	Fuel	
Coolant	174	F 900 R A2 (0K31)	222
Tyres	175	Engine oil	222
Wheel rims	176	Engine	
Wheels	176	F 900 R (0K11)	223
Chain	186	Engine	
Lighting	189	F 900 R A2 (0K31)	224
Jump-starting	190	Clutch	225
Battery	191	Transmission	225
Fuses	195	Final drive	225
Diagnostic connector	197	Frame	226
		Chassis and suspension	226
10 ACCESSORIES	198	Brakes	227
General notes	200	Wheels and tyres	227
Power sockets	200	Electrical system	228
Soft cases	201	Anti-theft alarm	229
Topcase	202	Dimensions	230
Navigation system	205	Weights	230
		Performance figures	231
11 CARE	210		
Care products	212		
Washing the vehicle	212		
Cleaning easily damaged components	213		
Care of paintwork	214		
Paintwork preservation	215		

13 SERVICE 232**Reporting safety-relevant defects 234****BMW Motorrad Service 235****BMW Motorrad Service history 235****BMW Motorrad mobility services 236****Maintenance work 236****Maintenance schedule 238****Maintenance confirmations 239****Service confirmations 251**

APPENDIX 254**Declaration of Conformity 255****Certificate for electronic immobiliser 260****Certificate for Keyless Ride 263****Certificate for tyre pressure control (RDC) 267****Certificate for TFT instrument cluster 268**

INDEX 272

GENERAL INSTRUCTIONS

01

OVERVIEW	4
ABBREVIATIONS AND SYMBOLS	4
EQUIPMENT	5
TECHNICAL DATA	5
CURRENCY	6
ADDITIONAL SOURCES OF INFORMATION	6
CERTIFICATES AND OPERATING LICENCES	6
DATA MEMORY	6
INTELLIGENT EMERGENCY CALL SYSTEM	11

4 GENERAL INSTRUCTIONS

OVERVIEW

Chapter 2 of this rider's manual will provide you with an initial overview of your motorcycle. All maintenance and servicing work on the motorcycle is documented in the "Service" section. The record of the maintenance work you have had performed on your vehicle is a precondition for generous treatment of goodwill claims. If the time comes to sell your BMW, please remember to hand over this rider's manual to the new owner. It is an important part of the motorcycle.

ABBREVIATIONS AND SYMBOLS

 **CAUTION** Low-risk hazard. Non-avoidance can lead to slight or moderate injury.

 **WARNING** Medium-risk hazard. Non-avoidance can lead to fatal or severe injury.

 **DANGER** High-risk hazard. Non-avoidance leads to fatal or severe injury.

 **ATTENTION** Special notes and precautionary measures. Non-compliance can lead to damage to the vehicle or ac-

cessory and, consequently, to voiding of the warranty.

 Specific instructions on how to operate, control, adjust or look after items of equipment on the motorcycle.

- Instruction.
- » Result of an activity.
-  Reference to a page with more detailed information.
- ◁ Indicates the end of a passage relating to specific accessories or items of equipment.



Tightening torque.



Technical data.

NV National-market version.

OE Optional equipment. The vehicles are assembled complete with all the BMW Motorrad optional equipment originally ordered.

- OA Optional accessories. You can obtain BMW Motorrad optional accessories through your authorised BMW Motorrad dealer; optional accessories have to be retrofitted to the vehicle.
- ABS Anti-lock brake system.
- D-ESA Electronic chassis and suspension adjustment.
- DTC Dynamic Traction Control.
- DWA Anti-theft alarm.
- EWS Electronic immobiliser.
- RDC Tyre pressure monitoring.

EQUIPMENT

When you ordered your BMW Motorrad, you chose various items of custom equipment. These operating instructions describe the optional equipment (OE) offered by BMW and selected optional accessories (OA). This explains why the manual may also contain descriptions

of equipment that you might not have selected. Please note, too, that on account of country-specific differences, your motorcycle might not be exactly as illustrated. If your motorcycle contains equipment that has not been described, its description can be found in a separate manual.

TECHNICAL DATA

All dimensions, weights and power ratings stated in the operating instructions are quoted to the standards and comply with the tolerance requirements of the Deutsches Institut für Normung e.V. (DIN). Technical data and specifications in this rider's manual serve as reference points. The vehicle-specific data may deviate from these, for example as a result of selected optional equipment, the national-market version or country-specific measuring procedures. Detailed values can be taken from the vehicle registration documents, or can be obtained from your authorised BMW Motorrad retailer or another qualified service partner or specialist workshop. The specifications in the vehicle documents always

6 GENERAL INSTRUCTIONS

have priority over the information provided in this rider's manual.

CURRENCY

The high safety and quality standards of BMW motorcycles are maintained by constant development work on designs, equipment and accessories. Because of this, your motorcycle may differ from the information supplied in the Rider's Manual. Nor can BMW Motorrad entirely rule out errors and omissions. We hope you will appreciate that no claims can be entertained on the basis of the data, illustrations or descriptions in these operating instructions.

ADDITIONAL SOURCES OF INFORMATION

Authorised BMW Motorrad retailer

Your authorised BMW Motorrad retailer will be happy to answer any questions you may have.

Internet

The rider's manual for your vehicle, operating and installation instructions for accessories and general information about BMW Motorrad, in relation to

technology, for example, are available for download from bmw-motorrad.com/manuals.

CERTIFICATES AND OPERATING LICENCES

The certificates for the vehicle and the official operating licences for accessories can be downloaded from bmw-motorrad.com/certification.

DATA MEMORY

General

Control units are installed in the vehicle. Control units process data that they receive, for example, from vehicle sensors, or that they generate themselves or exchange between each other. Some control units are required for the vehicle to function safely or provide assistance during riding, for example assistance systems. In addition, control units enable comfort or infotainment functions.

Information on data that has been stored or exchanged can be obtained from the manufacturer of the vehicle, for example via a separate booklet.

Personal reference

Each vehicle is identified with a clear vehicle identification number. Depending on the country, the vehicle identification number, the number plate and the corresponding authorities can be referenced to ascertain the vehicle owner. There are also other ways to use data obtained from the vehicle to trace the rider or vehicle owner, for example using the Connected-Drive user account.

Data protection rights

In accordance with applicable data protection laws, vehicle users have certain rights in relation to the manufacturer of the vehicle or in relation to companies which collect or process personal data.

Vehicle users have the right to obtain full information at no cost from persons or entities storing personal data of the vehicle user.

These entities may include:

- Manufacturer of the vehicle
- Qualified service partners
- Specialist workshops
- Service providers

Vehicle users have the right to request information on what personal data has been stored, for what purpose the data

is used, and where the data comes from. To obtain this information, proof of ownership or use is required.

The right to information also includes information about data that has been shared with other companies or entities. The website of the vehicle manufacturer contains the applicable data protection information. This data protection information includes information on the right to have data deleted or corrected. The manufacturer of the vehicle also provides their contact details and those of the data protection officer on their website.

The vehicle owner can also request that a BMW Motorrad retailer or another qualified service partner or specialist workshop read out the data that is stored in the vehicle for a charge.

The vehicle data is read out using the legally prescribed socket for on-board diagnosis (OBD) in the vehicle.

8 GENERAL INSTRUCTIONS

Legal requirements for the disclosure of data

As part of its legal responsibilities, the manufacturer of the vehicle is obligated to make its stored data available to the relevant authorities. This data is provided in the required scope in individual cases, for example to clarify a criminal offence. In the context of applicable laws, public agencies are entitled in individual cases to read out data from the vehicle themselves.

Operating data in the vehicle

Control units process data to operate the vehicle.

This includes, for example:

- Status reports of the vehicle and its individual components, for example wheel speed, wheel circumferential velocity, deceleration
- Environmental conditions, for example temperature

The data is only processed in the vehicle itself and is generally non-permanent. The data is not stored beyond the operating period.

Electronic components, for example control units, contain components for storing technical information. Information can be temporarily or perman-

ently stored on the vehicle condition, component loads, incidents or errors.

This information is generally used to document the condition of a component, a module, a system or the surrounding area, for example:

- Operating conditions of system components, for example filling levels, tyre pressure
- Malfunctions and faults in important system components, for example light and brakes
- Response of the vehicle in special riding situations, for example engagement of the driving dynamics systems
- Information on incidents resulting in damage to the vehicle

The data is necessary for the provision of control unit functions. Furthermore, the data is used to detect and rectify malfunctions and to enable the vehicle manufacturer to optimise vehicle functions.

The vast majority of this data is non-permanent and is only processed in the vehicle itself. Only a small amount of the data is stored in incident or fault memories as required by events.

If services are accessed, for example repairs, service processes, warranty cases and quality assurance measures, this technical information can be read out of the vehicle together with the vehicle identification number.

The information can be read out by a BMW Motorrad retailer or another qualified service partner or specialist workshop. The legally stipulated socket for on-board diagnosis (OBD) in the vehicle is used to read out the data. The data is obtained, processed and used by the relevant parts of the retailer network. The data is used to document the technical conditions of the vehicle, to help with error localization, to comply with warranty obligations and to improve quality.

In addition, the manufacturer has various product monitoring obligations arising from product liability legislation. To meet these obligations, the vehicle manufacturer requires technical data from the vehicle. The data from the vehicle can also be used to check warranty claims from the customer.

Error and incident memories in the vehicle can be reset during servicing or repair work by a BMW Motorrad retailer or another qualified service partner or specialist workshop.

Data input and data transfer in the vehicle

General

Depending on the equipment, comfort and customised settings can be stored in the vehicle and can be changed or reset at any time.

This includes, for example:

- Settings of the windscreen position
- Chassis and suspension settings

If required, data can be entered in the entertainment and communication system of the vehicle, for example using a smartphone.

Depending on the individual equipment, this includes:

- Multimedia data, such as music for playback
- Contacts data for use in connection with a communication system or an integrated navigation system
- Entered destinations
- Data on the use of internet services. This data can be stored locally in the vehicle

10 GENERAL INSTRUCTIONS

or is located on a device that is connected to the vehicle, for example smartphone, USB stick, MP3 player. If this data is stored in the vehicle, the data can be deleted at any time.

This data is transferred to third parties only if personally requested within the context of using online services. This depends on the selected settings when using the services.

Incorporation of mobile devices

Depending on the equipment, mobile devices connected to the vehicle, for example smartphones, can be controlled using the operating elements of the vehicle.

The image and sound of the mobile device can then be output via the multimedia system. At the same time, specific information is transferred to the mobile device. Depending on the type of integration, this includes, for example, position data and additional general vehicle information. This enables optimal use of the selected apps, for example navigation or music playback. The type of additional data processing is determined by the

provider of the respective app. The scope of the possible settings depends on the corresponding app and the operating system of the mobile device.

Services

General

If the vehicle has a wireless connection, this enables the exchange of data between the vehicle and other systems. The wireless connection is enabled by the vehicle's own transceiver unit or using personally integrated mobile devices, for example smartphones. Online functions can be accessed through this wireless connection. These include online services and apps that are provided by the vehicle manufacturer or by other providers.

Services of the vehicle manufacturer

For online services of the vehicle manufacturer, the individual functions are described at suitable points, for example rider's manual, website of the manufacturer. At the same time, information is also provided on the relevant data protection law. Personal data may be used to provide online services. Data

is exchanged using a secure connection, for example with the IT systems provided by the vehicle manufacturer.

Obtaining, processing and using personal data outside of the normal provision of services requires legal permission, contractual agreement or consent. It is also possible to have the entire data connection activated or deactivated. Statutory functions are excluded from this.

Services from other providers

When using online services from other providers, these services are subject to the responsibility and the data protection and operating conditions of the individual provider. The vehicle manufacturer has no influence on the content that is exchanged in this instance. Information on the type, scope and purpose of the data capture and use of personal data as part of the services of third parties can be ascertained from the individual provider.

INTELLIGENT EMERGENCY CALL SYSTEM

–with intelligent emergency call^{OE}

Principle

The intelligent emergency call system enables manual or automatic emergency calls, for example in the event of an accident.

The emergency calls are received by an emergency call centre that is commissioned by the vehicle manufacturer.

For information on operating the intelligent emergency call system and its functions, please refer to "Intelligent emergency call".

Legal basis

Processing of personal data using the intelligent emergency call system is in line with the following regulations:

–Protection of personal data:
Directive 95/46/EC of the European Parliament and of the Council.

–Protection of personal data:
Directive 2002/58/EC of the European Parliament and of the Council.

The legal basis for the activation and function of the intelli-

12 GENERAL INSTRUCTIONS

gent emergency call system is the concluded ConnectedRide contract for this function, as well as the corresponding laws, ordinances and directives of the European Parliament and of the European Council.

The relevant ordinances and directives regulate the protection of natural persons during the processing of personal data.

The processing of personal data by the intelligent emergency call system satisfies the European directives for the protection of personal data. The intelligent emergency call system processes personal data only with the agreement of the vehicle owner.

The intelligent emergency call system and other services with additional benefits can process personal data only with the express permission of the person affected by the data processing, for example the vehicle owner.

SIM card

The intelligent emergency call system operates via the mobile phone network using the SIM card installed in the vehicle. The SIM card is permanently logged into the mobile phone

network to enable rapid connection setup. Data is sent to the vehicle manufacturer in the event of an emergency.

Improving quality

The data that is transferred in an emergency is also used by the manufacturer of the vehicle to improve product and service quality.

Location determination

The position of the vehicle can be determined exclusively by the mobile phone network provider based on the mobile phone site locations. It is not possible for the provider to trace a connection between the vehicle's VIN and the phone number of the installed SIM card. Only the manufacturer of the vehicle can link a VIN and the phone number of the SIM card installed in a particular vehicle.

Log data of emergency calls

The log data of emergency calls is stored in a memory of the vehicle. The oldest log data is regularly deleted. The log data includes, for example, information on when and where an emergency call was made. In exceptional cases, the log data can be read out of the

vehicle memory. As a rule, log data is only read out following a court order, and this is only possible if the corresponding devices are connected directly to the vehicle.

Automatic emergency call

The system is designed so that, following a sufficiently serious accident, which is detected by sensors in the vehicle, an emergency call is automatically activated.

Sent information

When making an emergency call using the intelligent emergency call system, the system forwards the same information to the designated emergency call centre as is forwarded to the public emergency operations centre by the statutory emergency call system eCall. In addition, the intelligent emergency call system sends the following additional information to an emergency call centre commissioned by the vehicle manufacturer and, if required, to the emergency services:

- Accident data, for example the direction of impact detected by the vehicle sensors, to assist the emergency services response.
- Contact details, for example the phone number of the installed SIM card and the phone number of the rider, if available, to enable rapid contact with those involved in the accident if required.

Data storage

The data for an activated emergency call is stored in the vehicle. The data contains information on the emergency call, for example the location and time of the emergency call. The voice recordings of the emergency call are stored at the emergency call centre. The voice recordings of the customer are stored for 24 hours in case details of the emergency call need to be analysed. After this, the voice recordings are deleted. The voice recordings of the employee of the emergency call centre are stored for 24 hours for quality assurance purposes.

14 GENERAL INSTRUCTIONS

Information on personal data

The data that is processed as part of the intelligent emergency call is processed exclusively to carry out the emergency call. As part of its statutory obligation, the manufacturer of the vehicle provides information about the data that it has processed and any data that it still has stored.

GENERAL VIEWS

02

GENERAL VIEW, LEFT SIDE	18
GENERAL VIEW, RIGHT SIDE	19
UNDERNEATH THE SEAT	20
MULTIFUNCTION SWITCH, LEFT	21
MULTIFUNCTION SWITCH, RIGHT	22
MULTIFUNCTION SWITCH, RIGHT	23
INSTRUMENT CLUSTER	24

18 GENERAL VIEWS

GENERAL VIEW, LEFT SIDE

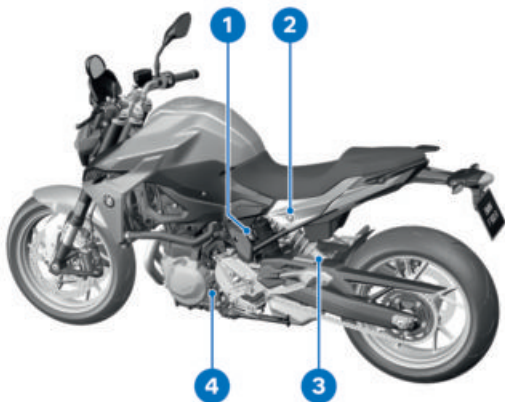

- 1 Power socket (☞ 200)
- 2 Seat lock (☞ 90)
- 3 Adjustment of damping (☞ 121)
- 4 Oil filler opening and oil dipstick (☞ 167)

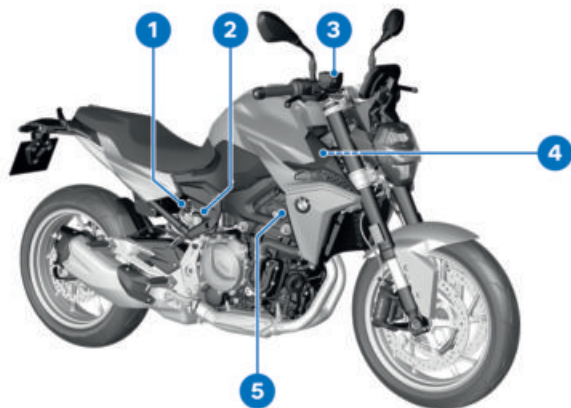
GENERAL VIEW, RIGHT SIDE

- 1** Adjustment of spring preload (➡ 120)
- 2** Brake-fluid reservoir, rear (➡ 172)
- 3** Brake-fluid reservoir, front (➡ 171)
- 4** Vehicle identification number, type plate (on steering head)
- 5** Coolant level indicator (behind the side trim panel) (➡ 174)

20 GENERAL VIEWS

UNDERNEATH THE SEAT

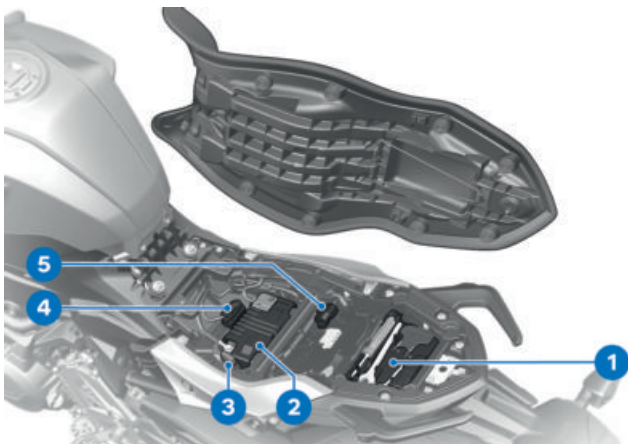

- 1 Toolkit (▮▮▮ 165)
- 2 Battery (▮▮▮ 191)
- 3 Main fuse (▮▮▮ 195)
- 4 Diagnostic connector (▮▮▮ 197)
- 5 Fuses (▮▮▮ 196)

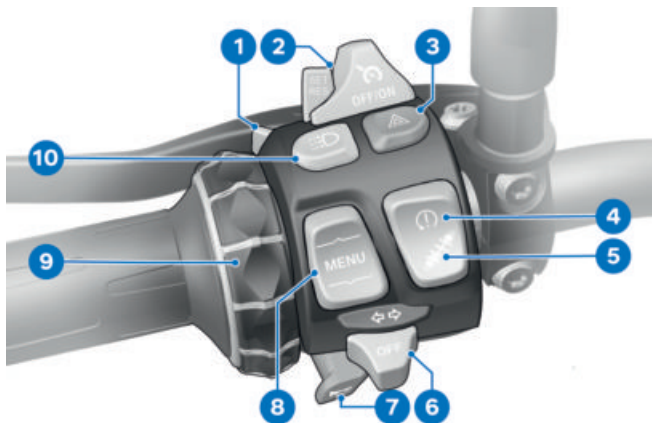
MULTIFUNCTION SWITCH, LEFT

- 1 High-beam headlight and headlight flasher (☞ 71)
- 2 Cruise control (☞ 82)
- 3 Hazard warning lights (☞ 74)
- 4 ASC/DTC (☞ 75)
- 5 Dynamic ESA (☞ 77)
- 6 Turn indicators (☞ 74)
- 7 Horn
- 8 MENU rocker button (☞ 95)
- 9 Multi-Controller Controls (☞ 95)
- 10 Manual daytime riding light (☞ 72)

22 GENERAL VIEWS

MULTIFUNCTION SWITCH, RIGHT

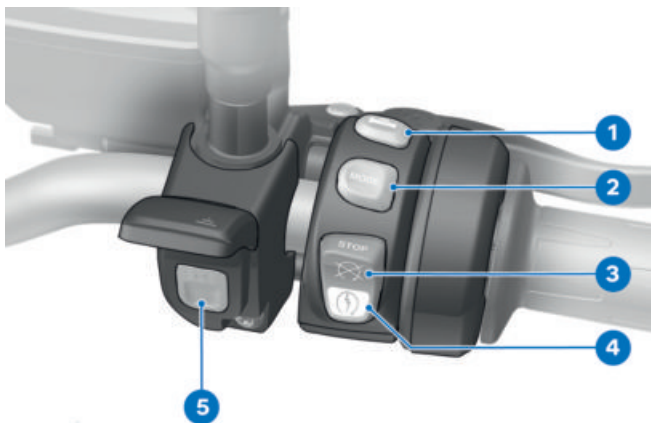

–with intelligent emergency call^{OE}

- 1 Operating heated handlebar grips (➔ 90)
- 2 Selecting riding mode (➔ 80)
- 3 Emergency-off switch (kill switch) (➔ 68)
- 4 Starter button (➔ 130)
- 5 SOS button
Intelligent emergency call (➔ 68)

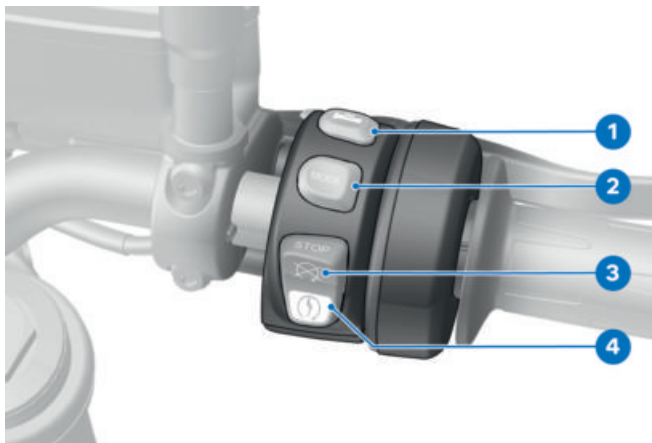
MULTIFUNCTION SWITCH, RIGHT

–without intelligent emergency call^{OE}

- 1** Operating heated handlebar grips (➔ 90)
- 2** Selecting riding mode (➔ 80)
- 3** Emergency-off switch (kill switch) (➔ 68)
- 4** Starter button (➔ 130)

24 GENERAL VIEWS

INSTRUMENT CLUSTER

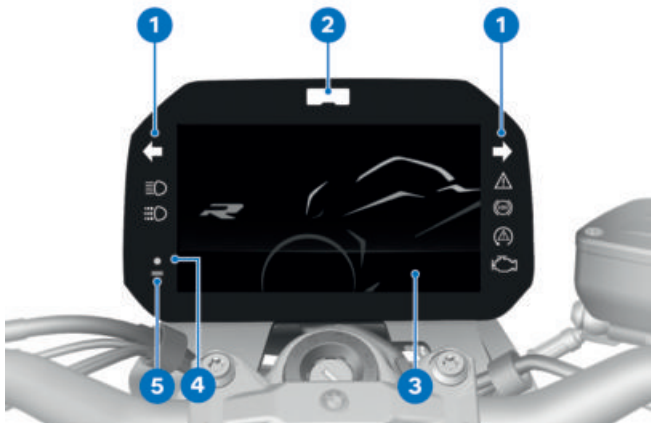

- 1 Indicator and warning lights (►► 28)
- 2 Shift light
- 3 TFT display (►► 29)
(►► 30)
- 4 DWA light-emitting diode
(►► 87)
–with Keyless Ride^{OE}
Indicator light for the radio-operated key (►► 64)
- 5 Photosensor (for adapting the brightness of the instrument lighting)

STATUS INDICATORS

03

INDICATOR AND WARNING LIGHTS	28
TFT DISPLAY IN PURE RIDE VIEW	29
TFT DISPLAY IN MENU VIEW	30
TFT DISPLAY IN SPORT 1 VIEW	31
TFT DISPLAY IN SPORT 2 VIEW	32
WARNING INDICATORS	33

28 STATUS INDICATORS

INDICATOR AND WARNING LIGHTS

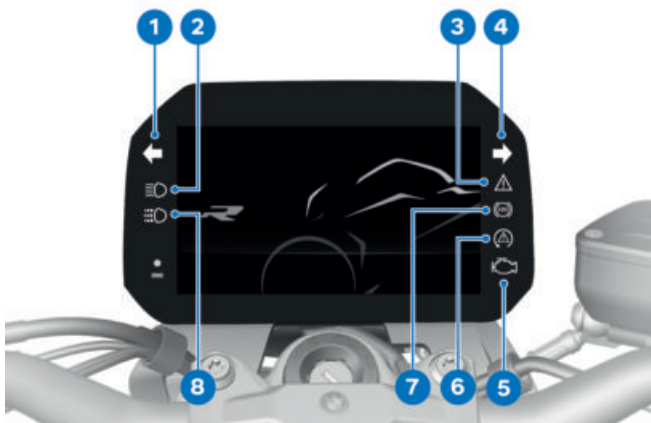

- 1 Turn indicators, left (➡ 74)
- 2 High-beam headlight (➡ 71)
- 3 General warning light (➡ 33)
- 4 Turn indicators, right (➡ 74)
- 5 Warning light, drive malfunction (➡ 45)
- 6 ASC/DTC (➡ 54)
- 7 ABS (➡ 53)
- 8 Manual daytime riding light (➡ 72)

TFT DISPLAY IN PURE RIDE VIEW

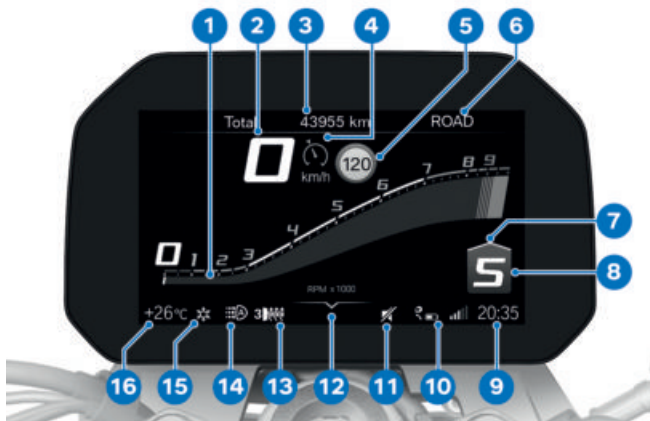

- | | |
|---|--|
| 1 Rev. counter (►►► 101) | 13 Heating stages, handlebar grips (►►► 90) |
| 2 Speedometer | 14 Automatic daytime riding light (►►► 73) |
| 3 Status line (►►► 99) | 15 Outside temperature warning (►►► 40) |
| 4 Cruise control (►►► 82) | 16 Ambient temperature |
| 5 Speed Limit Info (►►► 101) | |
| 6 Riding mode (►►► 79) | |
| 7 Recommendation to up-shift (►►► 102) | |
| 8 Gear indicator; "N" indicates neutral. | |
| 9 Clock (►►► 103) | |
| 10 Connection status (►►► 105) | |
| 11 Muting (►►► 102) | |
| 12 Operating help | |

30 STATUS INDICATORS

TFT DISPLAY IN MENU VIEW

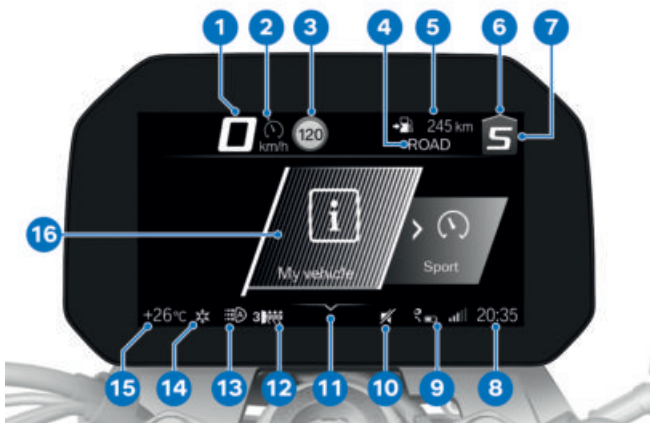

- | | |
|--|---|
| 1 Speedometer | 13 Automatic daytime riding light (►►► 73) |
| 2 Cruise control (►►► 82) | 14 Outside temperature warning (►►► 40) |
| 3 Speed Limit Info (►►► 101) | 15 Ambient temperature |
| 4 Riding mode (►►► 79) | 16 Menu section |
| 5 Status line (►►► 99) | |
| 6 Recommendation to up-shift (►►► 102) | |
| 7 Gear indicator; "N" indicates neutral. | |
| 8 Clock (►►► 103) | |
| 9 Connection status (►►► 105) | |
| 10 Muting (►►► 102) | |
| 11 Operating help | |
| 12 Heating stages, handlebar grips (►►► 90) | |

TFT DISPLAY IN SPORT 1 VIEW

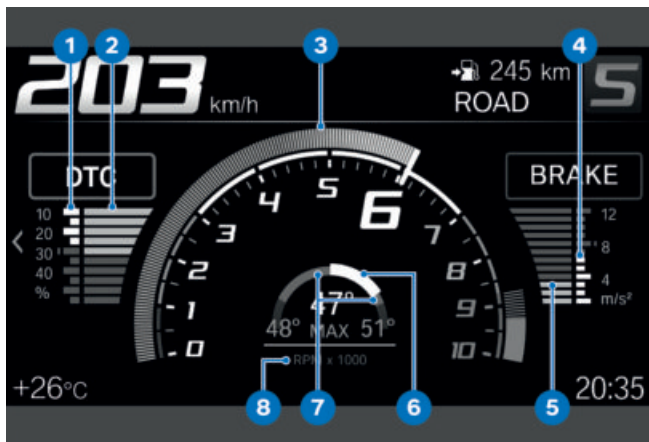

–with riding modes Pro^{OE}

- 1 Maximum DTC torque reduction
- 2 Current DTC torque reduction
- 3 Rev. counter
- 4 Maximum braking deceleration
- 5 Current braking deceleration
- 6 Current lean angle
- 7 Maximum lean angle
- 8 Unit for rpm display:
1000 revolutions per minute

32 STATUS INDICATORS

TFT DISPLAY IN SPORT 2 VIEW

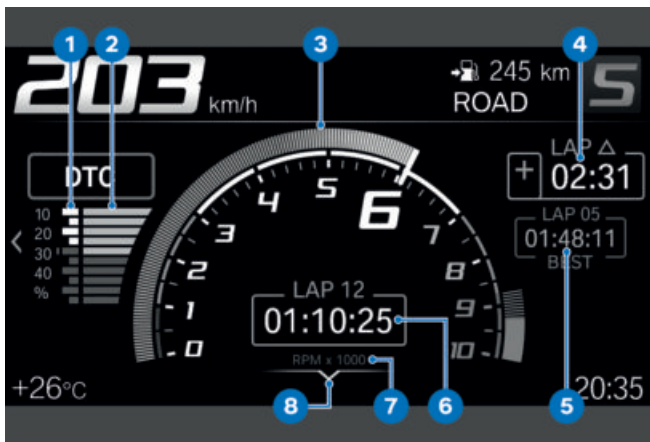

–with riding modes Pro^{OE}

- 1 Maximum DTC torque reduction
- 2 Current DTC torque reduction
- 3 Rev. counter
- 4 Difference between the last lap time and reference time or difference between current lap time and reference time
- 5 Reference time: fastest of the currently saved laps or all-time fastest saved lap
- 6 Current lap time (→ 84)

- 7 Unit for rpm display: 1000 revolutions per minute
- 8 Operating help

WARNING INDICATORS

Mode of presentation

Warnings are indicated by the corresponding warning lights. Warnings are indicated by the 'General' warning light showing in combination with a dialogue in the TFT display. The 'General' warning light shows yellow or red, depending on the urgency of the warning.

 The status of the 'General' warning light matches the most urgent warning. The possible warnings are listed on the next pages.

- Green CHECK OK **1**: no message, optimum values.
- White circle with small "i" **2**: information.
- Yellow warning triangle **3**: warning, value not ideal.
- Red warning triangle **3**: warning, value critical

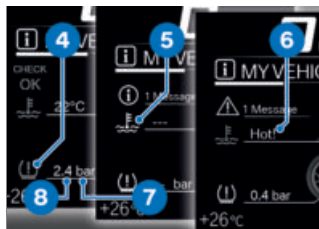

Values display

Symbols **4** differ in how they show on the display. The colours used differ and reflect the urgency of the message. Along with numerical values **8** with units **7**, texts **6** are displayed as well:

Colour of the symbol

- Green: (OK) Current value is ideal.
- Blue: (Cold!) Current temperature is too low.
- Yellow: (Low!/High!) Current value is too low or too high.
- Red: (Hot!/High!) Current temperature or value is too high.



Check Control display

The messages differ in how they show on the display. Different colours and symbols are used depending on priority:

34 STATUS INDICATORS

–White: (---) No valid value available. Dashes **5** are displayed instead of a numerical value.

 The assessment of some values is only possible from a certain journey duration or speed. If a measured value is still not being displayed because the conditions for measurement have not been met, dashes are displayed instead as a placeholder. If there are no valid measured values, there will be no assessment in the form of a coloured symbol.

ledged by tilting the Multi-Controller to the left.

–Check Control messages are dynamically attached as additional tabs on the pages in the menu *My vehicle* ( 97). You can go to the message again as long as the fault persists.

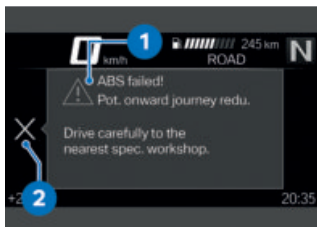





















Check Control dialogue





















Messages are output as Check Control dialogues **1**.



















- If there are two or more Check Control messages of equal priority, the messages keep changing in the order of their occurrence until they are acknowledged.
- If symbol **2** is actively displayed, it can be acknow-

Warnings, overview



















Indicator and warning lights	Display text	Meaning
	 is displayed.	Outside temperature warning (▶▶▶▶ 40)
 lights up yellow.	 Remote key not in range.	Radio-operated key out of range (▶▶▶▶ 40)
 lights up yellow.	 Keyless Ride failure.	Keyless Ride failed (▶▶▶▶ 41)
 lights up yellow.	 Remote key battery weak.	Replace battery of radio-operated key (▶▶▶▶ 41)
	 is displayed in yellow.	Voltage of the vehicle electrical system too low (▶▶▶▶ 41)
	 Vehicle voltage low.	
 lights up yellow.	 is displayed in yellow.	Voltage of the vehicle electrical system critical (▶▶▶▶ 42)
	 Vehicle voltage critical!	
 flashes yellow.	 is displayed in yellow.	Charging voltage critical (▶▶▶▶ 42)
	 Battery voltage critical!	
 lights up yellow.	 The faulty bulb is displayed.	Bulb faulty (▶▶▶▶ 43)
 flashes yellow.	 The faulty bulb is displayed.	
	 Alarm system batt. capacity weak.	Anti-theft alarm battery weak (▶▶▶▶ 44)









36 STATUS INDICATORS

Indicator and warning lights	Display text	Meaning
	 Alarm system battery empty.	Anti-theft alarm battery flat (▣▣▣▣ 44)
	 Alarm system failure.	DWA failed (▣▣▣▣ 45)
 lights up yellow.	 Coolant temperature too high!	Coolant temperature too high (▣▣▣▣ 45)
 lights up.	 Engine!	Drive malfunction (▣▣▣▣ 45)
 flashes red.	 Serious fault in the engine control!	Serious drive malfunction (▣▣▣▣ 46)
 flashes.		
 lights up yellow.	 No communication with engine control.	Engine control failed (▣▣▣▣ 46)
 lights up yellow.	 Fault in the engine control.	Engine in emergency-operation mode (▣▣▣▣ 46)
 flashes red.	 Serious fault in the engine control!	Severe fault in the engine control (▣▣▣▣ 47)
 lights up yellow.	 is displayed in yellow.	Tyre pressure close to limit of permitted tolerance (▣▣▣▣ 48)
	 Tyre pressure does not match setpoint.	
 lights up yellow.	 is displayed in yellow.	Tyre pressure outside permitted tolerance (▣▣▣▣ 49)

Indicator and warning lights	Display text	Meaning
	 Tyre pressure does not match setpoint.	Tyre pressure outside permitted tolerance (➡ 49)
	 Tyre press. control. Loss of pressure.	
	 "----"	Transmission fault (➡ 50)
 lights up yellow.	 "----"	Sensor faulty or system fault (➡ 50)
	 RDC sensor battery weak.	Battery for tyre pressure sensor weak (➡ 51)
 lights up yellow.	 Tyre pressure check failure!	Tyre pressure control (RDC) failed (➡ 51)
 lights up yellow.	 Drop sensor faulty.	Drop sensor defective (➡ 51)
 lights up yellow.	 Emergency call failure.	Emergency call function restricted (➡ 52)
 lights up yellow.	 Side stand monitoring faulty.	Side stand monitoring is faulty (➡ 52)
 flashes.		ABS self-diagnosis not completed (➡ 52)
 lights up yellow.	 Limited ABS availability!	ABS fault (➡ 52)
 lights up.		

38 STATUS INDICATORS

Indicator and warning lights	Display text	Meaning
 lights up yellow.	 ABS failure!	ABS failed (▣▣▣▣ 53)
 lights up.		
 lights up.	 ABS Pro failure!	ABS Pro failed (▣▣▣▣ 53)
 quick-flashes.		ASC/DTC intervention (▣▣▣▣ 54)
 slow-flashes.		ASC/DTC self-diagnosis not completed (▣▣▣▣ 54)
 lights up.	 Off!	ASC/DTC switched off (▣▣▣▣ 54)
	 Traction control deactivated.	
 lights up.	 Traction control limited!	ASC/DTC restricted (▣▣▣▣ 54)
 lights up.	 Traction control failure!	ASC/DTC fault (▣▣▣▣ 55)
 lights up yellow.	 Spring strut adjustment faulty!	D-ESA fault (▣▣▣▣ 55)
	 Fuel reserve reached. Go to a filling station soon	Fuel down to reserve (▣▣▣▣ 56)
	 flashes.	Gear not taugt (▣▣▣▣ 56)

Indicator and warning lights	Display text	Meaning
 flashes green.		Hazard warning lights system
 flashes green.		is switched on ( 57)
	 is displayed in white.	Service due ( 57)
	Service due!	
 lights up yellow.	 is displayed in yellow.	Service-due date has passed ( 57)
	Service over-due!	

40 STATUS INDICATORS

Ambient temperature

The ambient temperature is displayed status line of the TFT display.

When the vehicle is at a standstill, the heat of the engine can falsify the ambient-temperature reading. If the heat of the engine is affecting it too much, dashes are temporarily shown in place of the value.



There is a risk of black ice if the ambient temperature falls below the following limit value.



Limit value for the ambient temperature

approx. 3 °C

The first time the temperature drops below this value, the ambient-temperature reading and the ice crystal symbol flash in the status line of the TFT display.

Outside temperature warning



is displayed.

Possible cause:

The air temperature measured at the motorcycle is lower than 3 °C.



WARNING

Risk of black ice also applicable at over 3 °C

Risk of accident

- Always take extra care when temperatures are low; remember that there is particular danger of black ice forming on bridges and where the road is in shade.

- Ride carefully and think well ahead.

Radio-operated key out of range

–with Keyless Ride^{OE}



lights up yellow.



Remote key not in range. Not possible to switch on ignition again.

Possible cause:

Communication between radio-operated key and engine electronics is disrupted.

- Check the battery in the radio-operated key.
–with Keyless Ride^{OE}
- Replace the battery of the radio-operated key (▮▮▮▮ 66).
- Use the spare key to continue your journey.

–with Keyless Ride^{OE}

- Battery of the radio-operated key is empty or loss of the radio-operated key (➡ 65).
- Remain calm if the Check Control dialogue appears on the display while you are riding. You can continue your journey, the engine will not switch off.
- Have the faulty radio-operated key replaced by an authorised BMW Motorrad retailer.

Keyless Ride failed



lights up yellow.



Keyless Ride failure. Do not stop the engine. It may not be poss. to restart the engine.

Possible cause:

The Keyless Ride control unit has diagnosed a communication fault.

- Do not switch off the engine. Proceed as directly as possible to an authorised workshop, preferably an authorised BMW Motorrad retailer.
 - » Engine start with Keyless Ride can no longer be initiated.
 - » DWA can no longer be activated.

Replace battery of radio-operated key

–with Keyless Ride^{OE}



lights up yellow.



Remote key battery weak. Limited central locking function. Change battery.

Possible cause:

- The integral battery in the radio-operated key has lost a significant proportion of its original capacity. There is no assurance of how long the radio-operated key can remain operational.
- Replace the battery of the radio-operated key (➡ 66).

Voltage of the vehicle electrical system too low



is displayed in yellow.



Vehicle voltage low. Switch off unnecessary consumers.

The voltage of the vehicle electrical system is too low. If you continue to ride the motorcycle the on-board electronics will drain the battery.

42 STATUS INDICATORS

Possible cause:

Consumers with high power consumption are in operation (such as heated body warmers), too many consumers are in operation at one time, or battery faulty.

- Switch off non-essential consumers or disconnect them from the vehicle's electrical system.
- If the fault persists or occurs without consumers connected, have the fault rectified as quickly as possible by a specialist workshop, preferably an authorised BMW Motorrad retailer.

Voltage of the vehicle electrical system critical



lights up yellow.



is displayed in yellow.



Vehicle voltage critical! Consumers were switched off. Check battery condition.



WARNING

Failure of the vehicle systems

Risk of accident

- Do not continue your journey.

The voltage of the vehicle electrical system is critical. If you continue to ride the motorcycle the on-board electronics will drain the battery.

Possible cause:

Consumers with high power consumption are in operation (such as heated body warmers), too many consumers are in operation at one time, or battery faulty.

- Switch off non-essential consumers or disconnect them from the vehicle's electrical system.
- If the fault persists or occurs without consumers connected, have the fault rectified as quickly as possible by a specialist workshop, preferably an authorised BMW Motorrad retailer.

Charging voltage critical



flashes yellow.

 is displayed in yellow.

 Battery voltage critical! Accident risk. Stop driving.

 **WARNING**

Failure of the vehicle systems

Risk of accident

- Do not continue your journey.

The battery is not being charged. If you continue to ride the motorcycle the on-board electronics will drain the battery.

Possible cause:

Alternator or alternator drive faulty, battery faulty or fuse has blown.

- Have the fault rectified as quickly as possible by a specialist workshop, preferably an authorised BMW Motorrad retailer.

Bulb faulty

 lights up yellow.

 The faulty bulb is displayed:

 High beam faulty!

 Front left turn indicator faulty! or Front right turn indicator faulty!

 Low-beam headlight faulty!

 Front side light faulty!

–with daytime riding light^{OE}
 Daytime riding light faulty!◀

 Tail light faulty!

 Brake light faulty!

 Rear left turn indicator faulty! or Rear right turn indicator faulty!

 Number plate light faulty!

–Have it checked by a specialist workshop.

 flashes yellow.

 The faulty bulb is displayed:

 Active headlight faulty. Have it checked by a specialist workshop.

44 STATUS INDICATORS



WARNING

Vehicle overlooked in traffic due to failure of the lights on the vehicle

Safety risk

- Replace defective bulbs as soon as possible; always carry a complete set of spare bulbs if possible.

Possible cause:

Bulb faulty.

- Visually inspect to ascertain which bulb is faulty.
- Have LED light sources replaced as complete units; consult a specialist workshop, preferably an authorised BMW Motorrad retailer.

Anti-theft alarm battery weak –with anti-theft alarm (DWA)^{OE}



Alarm system batt. capacity weak. No restrictions. Make an appointment at a specialist workshop.



This error message shows briefly only after the Pre-Ride-Check completes.

Possible cause:

The integral battery in the anti-theft alarm has lost a significant proportion of its original capacity. There is no assurance of how long the anti-theft alarm can remain operational if the vehicle's battery is disconnected.

- Consult a specialist workshop, preferably an authorised BMW Motorrad retailer.

Anti-theft alarm battery flat –with anti-theft alarm (DWA)^{OE}



Alarm system battery empty. No independent alarm. Make an appointment at a specialist workshop.



This error message shows briefly only after the Pre-Ride-Check completes.

Possible cause:

The integral battery in the anti-theft alarm has lost its entire original capacity. There is no assurance that the anti-theft alarm will be operational if the motorcycle's battery is disconnected.

- Consult a specialist workshop, preferably an authorised BMW Motorrad retailer.

DWA failed

–with anti-theft alarm (DWA)^{OE}

 Alarm system failure. Have it checked by a specialist workshop.

Possible cause:

The DWA control unit has diagnosed a communication fault.

- Consult a specialist workshop, preferably an authorised BMW Motorrad retailer.
- » DWA can no longer be activated or deactivated.
- » False alarm possible.

Coolant temperature too high

 lights up yellow.

 Coolant temperature too high! Check coolant level. Continue driving in part load to cool down.

**ATTENTION****Riding with overheated engine**

Engine damage

- Compliance with the information set out below is essential.

Possible cause:

The coolant level is too low.

- Check the coolant level (▮▮▮ 174).

If the coolant level is too low:

- Top up the coolant (▮▮▮ 174).

Possible cause:

The coolant temperature is too high.

- If possible, ride in the part-load range to cool down the engine.
- In traffic jams, switch off the engine, but leave the ignition switched on so that the radiator fan continues to operate.
- If the coolant temperature is frequently too high, have the fault rectified as soon as possible by a specialist workshop, preferably an authorised BMW Motorrad retailer.

Drive malfunction

 lights up.

 Engine! Have it checked by a specialist workshop.

Possible cause:

The engine control unit has diagnosed a fault that affects pollutant emissions and/or reduces power.

- Have the fault rectified by a specialist workshop,

46 STATUS INDICATORS

preferably an authorised BMW Motorrad retailer.

» You can continue riding; pollutant emissions are higher than the threshold values.

Serious drive malfunction



flashes red.



flashes.



Serious fault in the engine control! Riding at mod. speed pos. Damage possible. Have checked by workshop.

Possible cause:

The engine control unit has diagnosed a fault that can lead to damage to the exhaust system.

- Have the fault rectified as quickly as possible by a specialist workshop, preferably an authorised BMW Motorrad retailer.

» It is possible to continue to ride but not recommended.

Engine control failed



lights up yellow.



No communication with engine control. Multiple sys. affected. Ride carefully to the next specialist workshop.

Engine in emergency-operation mode



lights up yellow.



Fault in the engine control. Onward journey possible. Ride carefully to next specialist workshop.



WARNING

Unusual ride characteristics when engine running in emergency-operation mode

Risk of accident

- Avoid accelerating sharply and overtaking.

Possible cause:

The engine control unit has diagnosed a fault. In exceptional cases, the engine stops and refuses to start. Otherwise, the engine runs in emergency operating mode.

- You can continue to ride, but bear in mind that the usual engine performance might not be available.
- Have the fault rectified as quickly as possible by a specialist workshop, preferably an authorised BMW Motorrad retailer.

Severe fault in the engine control



flashes red.



Serious fault in the engine control! Riding at mod. speed pos. Damage possible. Have checked by workshop.



WARNING

Engine damage when running in emergency-operation mode

Risk of accident

- Ride slowly, avoid accelerating sharply and overtaking.
- If possible, have the vehicle picked up and have the fault rectified by a specialist workshop, preferably an authorised BMW Motorrad Retailer.

Possible cause:

The engine control unit has diagnosed a fault which may cause severe secondary faults. The engine is in emergency-operation mode.

- Avoid high load and rpm ranges if possible.
- Have the fault rectified as quickly as possible by a specialist workshop, preferably an

authorised BMW Motorrad retailer.

» It is possible to continue to ride but not recommended.

Tyre pressure

—with tyre pressure control (RDC)^{OE}

In addition to the MY VEHICLE menu screen and the Check Control messages, there is also the TYRE PRESSURE screen for showing the tyre pressures:

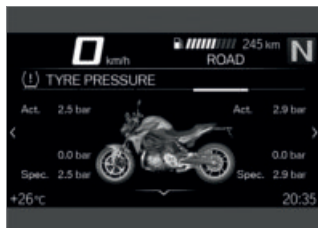

The values on the left are for the front wheel; those on the right are for the rear wheel. Actual and specified tyre pressures and the difference between them are displayed for each wheel. Immediately after the ignition is switched on, only dashes are displayed. The sensors do not start transmitting tyre pressure signals until the first time the vehicle accelerates to

48 STATUS INDICATORS

more than the minimum speed stated below:



RDC sensor is not active

min 30 km/h (The RDC sensor does not transmit its signal to the vehicle until a certain minimum speed has been reached.)



The tyre pressures are shown in the TFT display as temperature compensated and always refer to the following tyre air temperature:

20 °C



If the tyre symbol appears as well, showing yellow or red, this is a warning. The pressure difference is highlighted with an exclamation point in the same colour.



If the value in question is close to the limit of the permissible tolerance range, the reading is accompanied by the 'General' warning light showing yellow.



The 'General' warning light flashes red if the tyre pressure registered by the

sensor is outside the permissible tolerance range.

For further information about BMW Motorrad RDC, see the section entitled "Engineering details" (►► 157).

Tyre pressure close to limit of permitted tolerance

—with tyre pressure control (RDC)^{OE}



lights up yellow.



is displayed in yellow.



Tyre pressure does not match setpoint. Check tyre pressure.

Possible cause:

Measured tyre pressure is close to the limit of permitted tolerance.

- Correct tyre pressure.
- Before adjusting tyre pressure, read the information on temperature compensation and adjusting pressure in the section entitled "Engineering details":

» Temperature compensation (►► 158)

» Pressure adaptation (►► 158)

» Find the correct tyre pressures in the following places:

- Back cover of the rider's manual
- Instrument cluster in the TYRE PRESSURE view
- Sign under the seat

Tyre pressure outside permitted tolerance

- with tyre pressure control (RDC)^{OE}



lights up yellow.



is displayed in yellow.



Tyre pressure does not match setpoint. Stop immediately! Check tyre pressure.



Tyre press. control. Loss of pressure. Stop immediately! Check tyre pressure.



WARNING

Tyre pressure outside the permitted tolerance.

Risk of accident, degradation of the vehicle's driving characteristics.

- Adapt your style of riding accordingly.

Possible cause:

Measured tyre pressure is outside permitted tolerance.

- Check the tyre for damage and to ascertain whether the vehicle can be ridden with the tyre in its present condition. If the vehicle can be ridden with the tyre in its present condition:

- Correct the tyre pressure at the earliest possible opportunity.
- Before adjusting tyre pressure, read the information on temperature compensation and adjusting pressure in the section entitled "Engineering details":

» Temperature compensation (▣▣▣ 158)

» Pressure adaptation (▣▣▣ 158)

» Find the correct tyre pressures in the following places:

- Back cover of the rider's manual
- Instrument cluster in the TYRE PRESSURE view
- Sign under the seat
- Have the tyre checked for damage by a specialist workshop, preferably an authorised BMW Motorrad retailer.

If you are unsure whether the vehicle can be ridden with the tyre in its present condition:

- Do not continue your journey.

50 STATUS INDICATORS

- Notify the breakdown service.

Transmission fault

–with tyre pressure control (RDC)^{OE}



"---"

Possible cause:

The vehicle has not reached the minimum speed (157).



RDC sensor is not active

min 30 km/h (The RDC sensor does not transmit its signal to the vehicle until a certain minimum speed has been reached.)

- Increase speed above this threshold and observe the RDC readings.



Assume that a permanent fault has not occurred unless the 'General' warning light comes on to accompany the symptoms.

Under these circumstances:

- Have the fault rectified by a specialist workshop, preferably an authorised BMW Motorrad retailer.

Possible cause:

Wireless communication with the RDC sensors has been disrupted. Radio systems are located in the surrounding area which are interfering with the transmission between the RDC control unit and the sensors.

- Move to another location and observe the RDC readings.



Assume that a permanent fault has not occurred unless the 'General' warning light comes on to accompany the symptoms.

Under these circumstances:

- Have the fault rectified by a specialist workshop, preferably an authorised BMW Motorrad retailer.

Sensor faulty or system fault

–with tyre pressure control (RDC)^{OE}



lights up yellow.



"---"

Possible cause:

Vehicle is fitted with wheels not equipped with RDC sensors.

- Fit wheels and tyres equipped with RDC sensors.

Possible cause:

1 or 2 RDC sensors have failed or there is a system fault.

- Have the fault rectified by a specialist workshop, preferably an authorised BMW Motorrad retailer.

Battery for tyre pressure sensor weak

–with tyre pressure control (RDC)^{OE}

 RDC sensor battery weak. Function limited. Have it checked by a specialist workshop.

 This error message shows briefly only after the Pre-Ride-Check completes.

Possible cause:

The integral battery in the tyre-pressure sensor has lost a significant proportion of its original capacity. There is no assurance of how long the tyre pressure monitoring system can remain operational.

- Consult a specialist workshop, preferably an authorised BMW Motorrad retailer.

Tyre pressure control (RDC) failed

–with tyre pressure control (RDC)^{OE}

 lights up yellow.

 Tyre pressure check failure! Function limited. Have it checked by a specialist workshop.

Possible cause:

The tyre pressure control (RDC) control unit has diagnosed a communication fault.

- Consult a specialist workshop, preferably an authorised BMW Motorrad retailer.
- » Tyre pressure warnings not available.

Drop sensor defective

 lights up yellow.

 Drop sensor faulty. Have it checked by a specialist workshop.

Possible cause:

The drop sensor is not available.

- Consult a specialist workshop, preferably an authorised BMW Motorrad retailer.

52 STATUS INDICATORS

Emergency call function restricted

–with intelligent emergency call^{OE}



lights up yellow.



Emergency call failure. Make an appointment at a specialist workshop.

Possible cause:

The emergency call cannot be made automatically or via BMW.

- Consult the information on operating the intelligent emergency call on page (▶▶▶ 68)ff.
- Consult a specialist workshop, preferably an authorised BMW Motorrad retailer.

Side stand monitoring is faulty



lights up yellow.



Side stand monitoring faulty. Onward journey possible. Engine stop. when stationary! Have checked by workshop.

Possible cause:

The side-stand switch or its wiring are damaged. The engine is shut down when speed drops below 5 km/h. You cannot resume your journey.

- Consult a specialist workshop, preferably an authorised BMW Motorrad retailer.

ABS self-diagnosis not completed



flashes.

Possible cause:

The ABS function is not available, because self-diagnosis did not complete. The motorcycle has to move forward a few metres for the wheel sensors to be tested.

- Pull away slowly. Bear in mind that the ABS function is not available until self-diagnosis has completed.

ABS fault



lights up yellow.



lights up.



Limited ABS availability! Onward journey possible. Ride carefully to next specialist workshop.

Possible cause:

The ABS control unit has detected a fault. The ABS function is available, subject to restrictions.

- You can continue to ride. Bear in mind the more detailed information on certain situations that can lead to an ABS fault message (▮▮▮▮ 149).
- Have the fault rectified as quickly as possible by a specialist workshop, preferably an authorised BMW Motorrad retailer.

ABS failed



lights up yellow.



lights up.



ABS failure! Onward

journey possible. Ride carefully to next specialist workshop.

Possible cause:

The ABS control unit has detected a fault.

- You can continue to ride. Bear in mind that the ABS function is not available. Take note of the more detailed information on certain situations that can lead to an ABS fault message (▮▮▮▮ 149).

- Have the fault rectified as quickly as possible by a specialist workshop, preferably an authorised BMW Motorrad retailer.

ABS Pro failed

—with riding modes Pro^{OE}



lights up.



ABS Pro failure! Onward journey possible. Ride carefully to next specialist workshop.

Possible cause:

The ABS Pro control unit has detected a fault. The ABS Pro function is not available. The ABS function is available, subject to restrictions. ABS provides support only for braking in straight-ahead driving.

- You can continue to ride. Bear in mind the more detailed information on certain situations that can lead to an ABS Pro fault message (▮▮▮▮ 149).
- Have the fault rectified as quickly as possible by a specialist workshop, preferably an authorised BMW Motorrad retailer.

54 STATUS INDICATORS

ASC/DTC intervention



quick-flashes.

The ASC/DTC has detected a degree of instability at the rear wheel and has intervened to reduce torque. The indicator and warning light flashes for longer than ASC/DTC intervention lasts. This affords the rider visual feedback on control intervention even after the critical situation has been dealt with.

ASC/DTC self-diagnosis not completed



slow-flashes.

Possible cause:



ASC/DTC self-diagnosis not completed

The ASC/DTC function is not available, because self-diagnosis did not complete. (The motorcycle has to reach a defined minimum speed for the wheel sensors to be checked: min 5 km/h)

- Pull away slowly. The ASC/DTC indicator and warning light must go out after a few metres.

If the ASC/DTC indicator and warning light continues flashing:

- Seek the advice of a specialist workshop, preferably an authorised BMW Motorrad retailer.

ASC/DTC switched off



lights up.



Off!



Traction control deactivated.

Possible cause:

The rider has switched off the ASC/DTC system.

- Switch on the ASC/DTC function (► 76).

ASC/DTC restricted



lights up.



Traction control limited! Onward journey possible.

Ride carefully to next specialist workshop.

Possible cause:

The ASC/DTC control unit has detected a fault.

**ATTENTION****Damaged components**

Damage to sensors, for example, which causes malfunctions

- Do not transport any objects underneath the driver or passenger seat.
 - Secure the toolkit.
- Do not damage the angular rate sensor.
 - Bear in mind that the ASC/DTC function is restricted.
 - You can continue to ride. Bear in mind the more detailed information on situations that can lead to a ASC/DTC fault (➡ 152).
 - Have the fault rectified as quickly as possible by a specialist workshop, preferably an authorised BMW Motorrad retailer.

ASC/DTC fault

lights up.



Traction control failure! Onward journey possible. Ride carefully to next specialist workshop.

Possible cause:

The ASC/DTC control unit has detected a fault.

**ATTENTION****Damaged components**

Damage to sensors, for example, which causes malfunctions

- Do not transport any objects underneath the driver or passenger seat.
 - Secure the toolkit.
- Do not damage the angular rate sensor.
 - Bear in mind that the ASC/DTC function and dynamic engine brake control are not available.
 - You can continue to ride. Bear in mind the more detailed information on situations that can lead to an ASC/DTC fault (➡ 152).
 - Have the fault rectified as quickly as possible by a specialist workshop, preferably an authorised BMW Motorrad retailer.

D-ESA fault

lights up yellow.



Spring strut adjustment faulty! Onward journey possible. Ride

56 STATUS INDICATORS

carefully to next specialist workshop.

Possible cause:

The D-ESA control unit has detected a fault. The damping and/or spring adjuster may be the cause. In this condition, the motorcycle may have too much damping and is uncomfortable to drive, especially on roads in poor condition. Alternatively, the spring preload may be incorrectly adjusted.

- Have the fault rectified as quickly as possible by a specialist workshop, preferably an authorised BMW Motorrad retailer.

Fuel down to reserve



Fuel reserve reached. Go to a filling station soon.



WARNING

Irregular engine operation or engine shutdown due to lack of fuel

Risk of accident, damage to catalytic converter

- Do not run the fuel tank dry.

Possible cause:

The fuel tank contains no more than the reserve quantity of fuel.



Reserve fuel

approx. 3.5 l

- Refuelling (▮▮▮ 140).

Gear not taught

–with shift assistant Pro^{OE}



The gear indicator flashes. The Pro shift assistant is not available.

Possible cause:

–with shift assistant Pro^{OE}

The gearbox sensor is not fully trained.

- Select neutral N and allow the engine to idle for at least 10 seconds to teach the neutral position.
- Use clutch control to engage each gear in turn and ride for a minimum of 10 seconds in each gear.
 - » The gear indicator stops flashing when the gearbox sensor has been trained successfully.
- When the gearbox sensor has been taught successfully, Gear Shift Assistant Pro works as described (▮▮▮ 159).
- If teaching is not successful, have the fault rectified

by a specialist workshop, preferably an authorised BMW Motorrad retailer.

Hazard warning lights system is switched on



flashes green.



flashes green.

Possible cause:

The driver has switched on the hazard warning lights system.

- Operating hazard warning flashers (➔ 74).

Service display



If service is overdue, the due date or the odometer reading at which service was due is accompanied by the 'General' warning light showing yellow.

If the service is overdue, a yellow CC message is displayed. Exclamation marks also draw your attention to the displays for service, service appointment and countdown distance in the MY VEHICLE and SERVICE REQUIREMENTS menu screens.



If the service-due indicator appears more than a month before the service date, the current date has to be corrected. This situation can occur

if the battery was disconnected.

Service due



is displayed in white.

Service due! Have service performed by a specialist workshop. Possible cause:

Service is due, because of either distance covered or time expired.

- Have your motorcycle serviced regularly by a specialist workshop, preferably by an authorised BMW Motorrad retailer.
- » The vehicle remains operationally reliable and road-worthy.
- » The vehicle retains its value.

Service-due date has passed



lights up yellow.



is displayed in yellow.

Service overdue! Have service performed by a specialist workshop.

58 STATUS INDICATORS

Possible cause:

Service is overdue because of the driving performance or the date.

- Have your motorcycle serviced regularly by a specialist workshop, preferably by an authorised BMW Motorrad retailer.
- » The vehicle remains operationally reliable and road-worthy.
- » The vehicle retains its value.

OPERATION

04

IGNITION SWITCH/STEERING LOCK	62
IGNITION WITH KEYLESS RIDE	63
ELECTRONIC IMMOBILISER EWS	67
EMERGENCY-OFF SWITCH (KILL SWITCH)	68
INTELLIGENT EMERGENCY CALL	68
LIGHTS	71
DAYTIME RIDING LIGHT	72
HAZARD WARNING LIGHTS	74
TURN INDICATORS	74
TRACTION CONTROL (ASC/DTC)	75
ELECTRONIC SUSPENSION ADJUSTMENT (D-ESA)	77
RIDING MODE	79
RIDING MODE PRO	81
CRUISE CONTROL	82
LAPTIMER	84
SHIFT LIGHT	86
ANTI-THEFT ALARM (DWA)	86
TYRE PRESSURE CONTROL (RDC)	89
HEATED GRIPS	90
SEAT	90

62 OPERATION

IGNITION SWITCH/STEERING LOCK

Keys

You receive two vehicle keys. If a key is lost or mislaid, consult the notes on the electronic immobiliser (EWS) (▣▣▣ 67). Ignition switch, fuel filler cap lock and seat lock are all operated with the same key.

- with case^{OA}
- with topcase^{OA}

If you wish you can arrange to have the cases and the topcase fitted with locks that can be opened with this key as well. Consult a specialist workshop, preferably an authorised BMW Motorrad retailer.

Engaging steering lock

- Turn the handlebars all the way to the left.

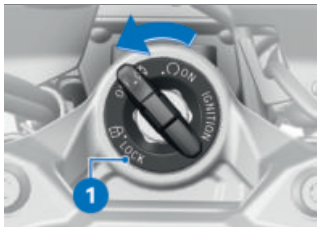

- Turn the key to position **1** while moving the handlebars slightly.

- » Ignition, lights and all function circuits switched off.
- » Steering lock engaged.
- » Key can be removed.

Switching on ignition

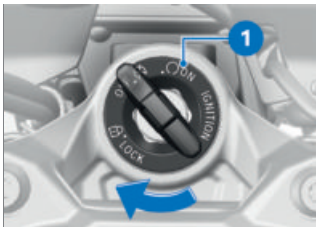

- Turn the key to position **1**.
 - » Side lights and all function circuits switched on.
 - » Engine can be started.
 - » Pre-Ride-Check is performed. (▣▣▣ 131)
 - » ABS self-diagnosis is in progress. (▣▣▣ 132)
 - » ASC self-diagnosis is in progress. (▣▣▣ 132)
 - » DTC self-diagnosis is in progress. (▣▣▣ 133)

Welcome lights

- Switch on the ignition.
 - » The side lights briefly light up.
 - with daytime riding light^{OE}
 - » The daytime riding lights briefly light up.◁

Switching off ignition

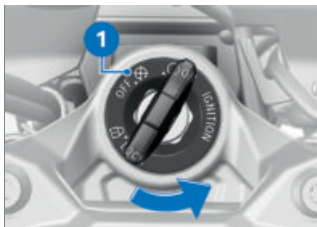

- Turn the key to position **1**.
 - » Lights switched off.
 - » Handlebars not locked.
 - » Key can be removed.
 - » Electrically powered accessories remain operational for a limited period of time.
 - » The battery can be recharged via the vehicle socket.

IGNITION WITH KEY-LESS RIDE

–with Keyless Ride^{OE}

Keys

 The telltale light for the radio-operated key flashes while the search for the radio-operated key is in progress. The light goes out as soon as the radio-operated key or the emergency key is found. The light goes out briefly if the search times out without the radio-operated key or the emergency key being found.

You receive one radio-operated key and one spare key. If a key is lost or mislaid, consult the notes on the electronic immobiliser (EWS) (▶ 67). Ignition, fuel filler cap and anti-theft alarm system all work with the radio-operated key. Seat lock, topcase and cases can be locked and unlocked manually.

 The vehicle cannot be started if the radio control key is not within range (e.g. key inside one of the cases or the topcase). If the radio-operated key remains out of range, the ignition is switched off after about 1.5 minutes to protect the battery. It is advisable to keep the radio-operated key on your person (e.g. in a jacket pocket) and to have the emergency key with you as an alternative.

 Range of the Keyless Ride radio-operated key

–with Keyless Ride^{OE}

approx. 1 m◁

64 OPERATION

Engaging steering lock

Requirement

Handlebars are turned to the left. Radio-operated key is within range.

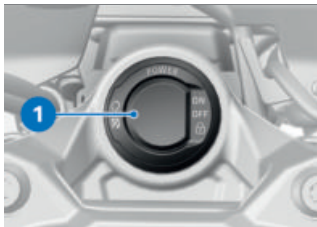

- Press and hold down button **1**.
 - » The steering lock engages with an audible click.
 - » Ignition, lights and all function circuits switched off.
- Short-press button **1** to disengage the steering lock.

Switching on ignition

Requirement

Radio-operated key is within range.

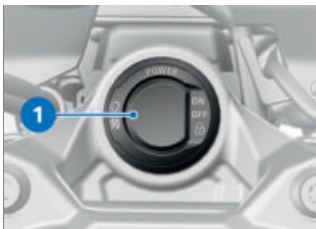

- There are **two** ways of activating the ignition.

Version 1:

- Short-press button **1**.
 - » Side lights and all function circuits are switched on.
 - with daytime riding light^{OE}
 - » Daytime riding light is switched on.◁
 - » Pre-Ride-Check is performed. (▮▮▮ 131)
 - » ABS self-diagnosis is in progress. (▮▮▮ 132)
 - » ASC self-diagnosis is in progress. (▮▮▮ 132)
 - » DTC self-diagnosis is in progress. (▮▮▮ 133)

Version 2:

- Steering lock is engaged; press and hold down button **1**.
 - » The steering lock disengages.
 - » Side lights and all function circuits switched on.
 - » Pre-Ride-Check is performed. (▮▮▮ 131)
 - » ABS self-diagnosis is in progress. (▮▮▮ 132)

- » ASC self-diagnosis is in progress. (►► 132)
- » DTC self-diagnosis is in progress. (►► 133)

Switching off ignition Requirement

Radio-operated key is within range.

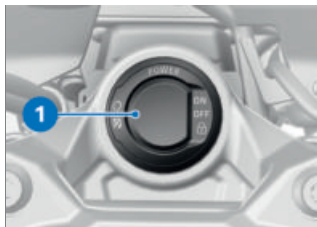

- There are **two** ways of deactivating the ignition.

Version 1:

- Short-press button **1**.
- » Light is switched off.
- » Handlebars (steering lock) are not locked.

Version 2:

- Turn the handlebars all the way to the left.
- Press and hold down button **1**.
- » Light is switched off.
- » The steering lock engages.

Battery of the radio-operated key is empty or loss of the radio-operated key

- If a key is lost or mislaid, consult the notes on the electronic immobiliser (**EWS**).
- If you happen to lose or mislay the radio-operated key while on a journey, you can start the vehicle with the spare key.
- If the battery of the radio-operated key is empty, the vehicle can be started by simply inserting the folded radio-operated key into the ring aerial under the seat.

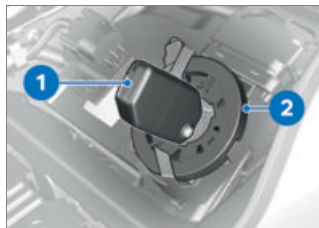

- Remove the seat (►► 90).
- Insert the spare key or folded-in radio-operated key with the empty battery **1** into ring aerial **2**.



The spare key or the closed radio-operated key with the empty battery **must be inserted into** the opening in the ring aerial.

66 OPERATION



Time during which the engine has to be started. The unlocking procedure has to be repeated if this time is allowed to expire.

30 s

- » Pre-Ride-Check is performed.
- Key has been recognised.
- Engine can be started.
- Start the engine (▣▣▣ 130).

Replacing battery of radio-operated key

Requirement

The radio-operated key does not react because the battery is weak.



Remote key battery weak. Limited central locking function. Change battery.



DANGER

Swallowing a battery

Risk of injury or death

- An ignition key contains a button cell as its battery. Batteries or button cells, if swallowed, can cause serious or fatal injury within two hours, for example resulting from internal burns or caustic action.
- Keep ignition keys and batteries out of reach of children.
- If there is any suspicion that a battery or button cell has been swallowed or is inside a part of the body, seek medical assistance immediately.

- Change the battery.

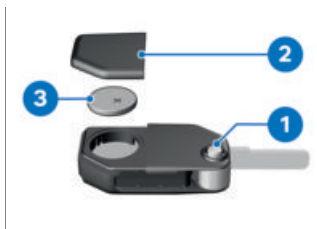

- Press button **1**.
 - » Key bit flips out.
- Push battery cover **2** up.
- Remove battery **3**.

- Dispose of the old battery in accordance with all applicable laws and regulations; do not attempt to dispose of batteries as domestic waste.



ATTENTION

Unsuitable or incorrectly inserted batteries

Component damage

- Use a battery compliant with the manufacturer's specifications.
 - When inserting the battery, always make sure polarity is correct.
- Insert the new battery with the positive terminal up.



Battery type

For Keyless Ride radio-operated key

CR 2032

- Install battery cover **2**.
 - » Red LED in the instrument cluster flashes.
 - » The radio-operated key is again ready for use.

ELECTRONIC IMMOBILISER EWS

The on-board electronics access the data saved in the vehicle key via a ring aerial in the ignition lock / R/C ignition lock. The ignition is not enabled for starting until the engine control unit has recognised the ignition key as "authorised" for your motorcycle.



A spare key attached to the same ring as the ignition key/radio-operated key used to start the engine could "irritate" the electronics, in which case the enabling signal for starting is not issued. Always keep the spare key separate from the ignition key/radio-operated key.

If you lose a key, you can have it barred by your BMW Motorrad authorised retailer. In order to have a key barred you must bring along all the other keys belonging to the motorcycle.

The engine cannot be started by a barred ignition key, but an ignition key that has been barred can subsequently be reactivated.

68 OPERATION

You can obtain extra keys only through an authorised BMW Motorrad retailer. The ignition keys are part of an integrated security system, so the retailer is under an obligation to check the legitimacy of all applications for replacement/extra keys.

EMERGENCY-OFF SWITCH (KILL SWITCH)



- 1 Emergency-off switch (kill switch)



WARNING

Operation of the kill switch while riding

Risk of fall due to rear wheel locking

- Do not operate the kill switch when riding.

The emergency off switch is a kill switch for switching off the engine quickly and easily.



- A Engine switched off
B Normal operating position (run)

INTELLIGENT EMERGENCY CALL

—with intelligent emergency call^{OE}

Emergency call via BMW

Press the SOS button in an emergency only. Even if an emergency call using BMW is not possible, the system may make an emergency call to a public emergency call number. This depends on the respective mobile phone network and the national regulations.

The emergency call is not able to be ensured because of technical reasons due to unfavourable conditions, e.g. in areas where there is no mobile phone reception.

Language for emergency call

Each vehicle has a language assigned to it depending on the market for which it is intended. The BMW Call Center answers in this language.

 A changeover of the language for the emergency call can only be performed by the BMW Motorrad partner. The language assigned to the vehicle varies from the selectable language the driver can choose as the display language in the multifunction display.

Manual emergency call Requirement

An emergency call has occurred. The vehicle is at a standstill. The ignition is switched on.



- Open cover **1**.
- Short-press SOS button **2**.

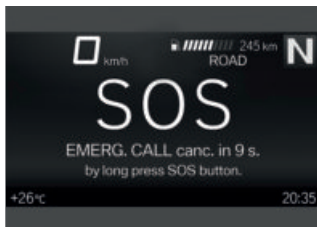

- » The time until transmission of the emergency call is displayed. During that time, it is possible to cancel the emergency call.
- Operate the emergency-off switch to stop the engine.
- Remove helmet.
- » After expiry of the timer, a voice contact to the BMW Call Center is established.

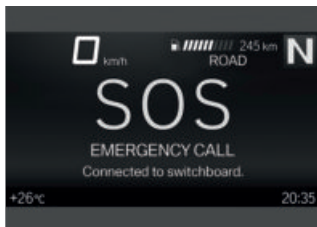

The connection was established.

70 OPERATION



- Provide information to the emergency services using the microphone **3** and speaker **4**.

Automatic emergency call

The intelligent emergency call is active after the ignition is switched on and reacts if a fall or crash occurs.

Emergency call in the event of a light fall

- A minor fall or a crash is detected.
- » An acoustic signal is sounded.

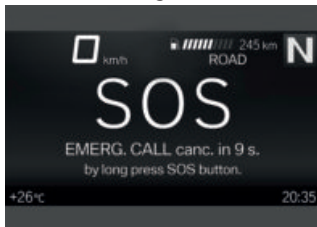

- » The time until transmission of the emergency call is displayed. During that time, it is

possible to cancel the emergency call.

- If possible, remove helmet and stop engine.
- » A voice contact connection to the BMW Call Center is established.

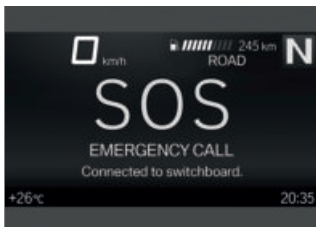

The connection was established.

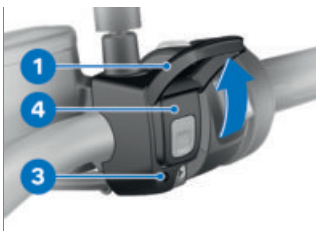

- Open cover **1**.
- Provide information to the emergency services using the microphone **3** and speaker **4**.

Emergency call in the event of a severe fall

- A severe fall or a crash is detected.

» The emergency call is placed automatically without delay.

LIGHTS

Low-beam headlight and sidelights

The side lights switch on automatically when the ignition is switched on.

 The side lights place a strain on the battery. Do not switch the ignition on for longer than absolutely necessary.

The low-beam headlight switches on automatically under the following conditions:

- When the engine is started.
- If the vehicle is pushed while the ignition is on.

 When the engine is not running you can switch on the lights by switching on the ignition and either switching on the high-beam headlight or operating the headlight flasher.

-with daytime riding light^{OE}
In daytime the daytime riding light can be switched on as an alternative to the low-beam headlight.

High-beam headlight and headlight flasher

• Switch on the ignition (➡ 62).



- Push switch **1** forward to switch on the high-beam headlight.
- Pull switch **1** back to operate the headlight flasher.

Headlight courtesy delay feature

• Switch off the ignition.



- Immediately after switching off the ignition, pull switch **1** back and hold it in that position until the headlight courtesy delay feature comes on.

72 OPERATION

- » The vehicle's lights come on for one minute and then switch off automatically.
- This can be used to light up the path to the house door after the vehicle has been parked, for example.

Parking lights

- Switch off the ignition (☞ 63).



- Immediately after switching off the ignition, push button **1** to the left and hold it in that position until the parking lights come on.
- Switch the ignition on and off again to switch off the parking lights.

DAYTIME RIDING LIGHT

–with daytime riding light^{OE}

Manual daytime riding light Requirement

Automatic daytime riding light is switched off.

WARNING

Switching on the daytime riding light in the dark.

Risk of accident

- Do not use the daytime riding light in the dark.

 By comparison with the low-beam headlight, the daytime running light makes the vehicle more visible to on-coming traffic. This improves daytime visibility.

- Start the engine (☞ 130).
- Navigate to **Settings**, **Vehicle settings**, **Lights** and switch off the **Auto. daytime light** function. (For mode detailed information on how to operate the Multi-Controller, see the section entitled "TFT display" (☞ 95).)



- Press button **1** to switch on the daytime riding light.

 The indicator light for the daytime riding light lights up.

- » The low-beam headlight and the front side lights are switched off.
- In the dark or in tunnels: Press button **1** again to switch off the daytime riding light and switch on the low-beam headlight and front side light.

 If the high-beam headlight is switched on while the daytime riding light is on, the daytime riding light is switched off after approx. 2 seconds and the high-beam headlight, low-beam headlight and front side light are switched on. If the high beam headlight is switched off again, the daytime running light is not automatically reactivated, but must be switched on again if required.

Automatic daytime riding light

WARNING

The automatic daytime riding light is not a substitute for the rider's personal judgement of the light conditions

Risk of accident

- Switch off the automatic daytime riding light in poor light conditions.

 The changeover between daytime riding light and low-beam headlight including front side lights can be effected automatically.

- Navigate to *Settings*, *Vehicle settings*, *Lights* and switch on the *Auto. daytime light* function.

 The indicator light for the automatic daytime riding light lights up.

- » If the ambient brightness decreases below a certain value, the low-beam headlight is automatically switched on (e.g. in a tunnel). When sufficient ambient brightness is detected, the daytime riding light is switched back on.

74 OPERATION

 The indicator light for the daytime riding light shows if the daytime riding light is active.

Manual operation of the light when the automatic system is switched on

- If you press the button for the daytime riding light the daytime riding light is switched off and the low-beam headlight and front side lights are switched on (e. g. when you ride into a tunnel, and the response of the automatic daytime riding light to the change in ambient brightness is delayed).
- If you press the button again the daytime riding light is reactivated, in other words the daytime riding light is switched on again when ambient light is bright enough.

HAZARD WARNING LIGHTS

Operating hazard warning flashers

- Switch on the ignition.

 The hazard warning flashers place a strain on the battery. Do not use the hazard warning flashers for longer than absolutely necessary.

 If you press a turn-indicator button while the hazard warning lights are switched on, the turn-indicator function is activated instead of the hazard warning flashers and remains active until you release the button. The hazard warning flashers recommence flashing as soon as the button is released.



- Press button **1** to switch on the hazard warning lights system.
- » Ignition can be switched off.
- To switch off the hazard warning lights system, switch on the ignition if necessary and press button **1** again.

TURN INDICATORS

Operating turn indicators

- Switch on the ignition.



- Push button **1** to the left to switch on the left turn indicators.
- Push button **1** to the right to switch on the right turn indicators.
- Centre button **1** to cancel the turn indicators.

Comfort turn indicator



If button **1** has been pressed to the right or left, the turn indicators are automatically switched off under the following circumstances:

- Speed below 30 km/h: after 50 m distance covered.
- Speed between 30 km/h and 100 km/h: after a speed-dependent distance covered or in case of acceleration.
- Speed over 100 km/h: after flashing five times.

If button **1** is pressed to the right or left slightly longer, the turn indicators only switch off automatically once the speed-dependent distance covered is reached.

TRACTION CONTROL (ASC/DTC)

Switch off the ASC/DTC function

- Switch on the ignition (▣▣▣ 62).

 You have the option of deactivating the ASC/DTC function while the motorcycle is on the move.

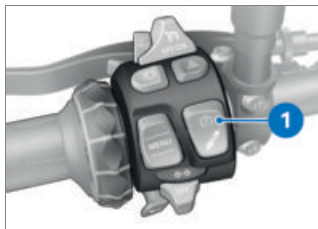

- Press and hold down button **1** until the ASC/DTC indicator

76 OPERATION

and warning light changes its status.

Immediately after button **1** is pressed, ASC/DTC system status **ON** is displayed.

 lights up.

Possible ASC system status **OFF!** is displayed.

- Release button **1** after the ASC/DTC system status changes.

 remains lit.

The new ASC/DTC system status **OFF!** is displayed briefly.

- » The ASC/DTC function is switched off.

Switch on the ASC/DTC function



- Press and hold down button **1** until the ASC/DTC indicator and warning light changes its status.

Immediately after button **1** is pressed, ASC/DTC system status **OFF!** is displayed.

 goes out; if self-diagnosis has not completed it starts flashing.

Possible ASC system status **ON** is displayed.

- Release button **1** once the status has changed.

 remains off or continues to flash.

The new ASC/DTC system status **ON** is displayed briefly.

- » The ASC/DTC function is switched on.
- You also have the option of switching the ignition off and then on again.

 If the ASC/DTC indicator and warning light remains on even though the vehicle has accelerated past the minimum speed stated below after the ignition was switched off and then on again, an ASC/DTC fault has occurred.

min 5 km/h

- For more information on ASC/DTC traction control, see the section entitled "Engineering details" (111111 151).

ELECTRONIC SUSPENSION ADJUSTMENT (D-ESA)

–with Dynamic ESA^{OE}

Possibilities for adjustment

Dynamic ESA (electronic chassis and suspension adjustment) provides a convenient way of adapting the damping characteristic of the rear suspension to the surface over which you intend riding. Two damper settings and three spring preload stages are available.

Viewing suspension settings



- Switch on the ignition (➡ 62).
- Short-press button **1** to view the current setting.

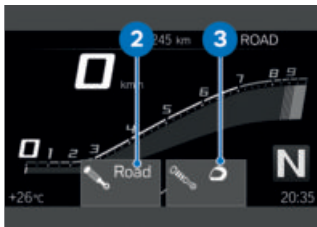

The settings for damping **2** and spring preload **3** are displayed.

» The setting shows briefly, then disappears automatically.

Adjusting suspension damping

- Switch on the ignition (➡ 62).

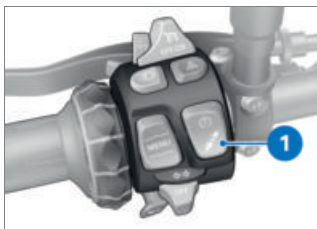

- Short-press button **1** to view the current setting.
- To adjust damping:
- Repeatedly short-press button **1** until the setting you want to use is displayed.

 You can adjust the damping characteristic while the motorcycle is on the move.

78 OPERATION

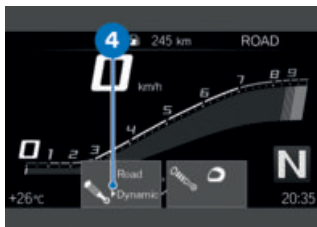

Selection arrow **4** is displayed.

» The selection arrow **4** disappears after the status is changed.

The following settings are available:

- Road: Damping for comfortable on-road riding
- Dynamic: Damping for dynamic on-road riding

Adjusting spring preload





To adjust spring preload:

- Start the engine (130).
- Repeatedly long-press button **1** until the setting you want to use is displayed.

 You cannot adjust spring preload while the motorcycle is on the move.

The following settings are available:

-  One-up riding
-  One-up with luggage
-  Two-up (with luggage)

The following message is displayed if it is not possible to adjust a setting: Load adjustment only avail. stopped.

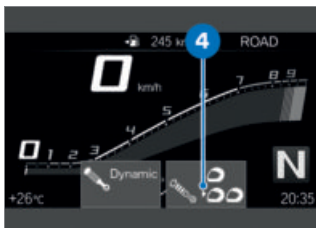

Selection arrow **4** is displayed.

» The selection arrow **4** disappears after the status is changed.

- Wait for the mechanism to complete all adjustments before you ride off.
- » The settings for damping and spring preload shown on the

display are automatically accepted if you allow a certain length of time to pass without pressing button 1.

RIDING MODE

Using riding modes

BMW Motorrad has developed operational scenarios for your motorcycle from which you can select the scenario suitable for your situation:

Standard

- RAIN: Riding on a rain-wet road surface.
- ROAD: Riding on a dry road surface.

–with riding modes Pro^{OE}

with Pro riding modes

- DYNAMIC: Dynamic riding on a dry road surface.
- DYNAMIC PRO: Dynamic riding on a dry road surface with provision for the rider's custom settings.

The respective optimum interplay of engine characteristic, ABS control and ASC/DTC control is provided for each of these scenarios.



See the section entitled "Engineering details" for more information on the selectable riding modes.

–with Dynamic ESA^{OE}

The chassis and suspension settings can also be adapted in the selected scenario.

Riding-mode preselection

–with riding modes Pro^{OE}

Riding mode preselection is a function for shortlisting the rider's subset of preferred riding modes.

Between two and a maximum of four riding modes can be added to the riding modes preselection shortlist.

Factory setting:

RAIN, ROAD, DYNAMIC and DYNAMIC PRO

Configuring riding-mode preselection

–with riding modes Pro^{OE}

- Switch on the ignition (▣▶ 62).
- Navigate to *Settings*, *Vehicle settings*, *Driving mode preselection*.
- Activate or deactivate riding modes for riding mode preselection.
 - » The activated riding modes are available for subsequent selection.
 - » If fewer than two riding modes are preselected, this message is displayed: *Action not possible. Min. number reached.*

80 OPERATION

- » If more than four riding modes are preselected, this message is displayed:
Action not possible.
Max. number reached.
- » The list of preselected riding modes is retained in memory, even after the ignition is switched off.

Selecting riding mode

- Switch on the ignition (➡ 62).



- Press button 1.



The riding mode currently active **2** is sent to the back and is displayed in the pop-up **3**. The guide **4** indicates how many riding modes are available.



- Repeatedly press button **1** until the riding mode you want is displayed in the pop-up.

 The intervention of riding dynamics control systems can be restricted, depending on which riding mode is selected and how the selected mode is configured.

Possible restrictions are indicated by a pop-up message, for example Warning! ABS & DTC setting..

See the section entitled "Engineering details" for more information on riding dynamics control systems such as ABS and ASC/DTC.

—with riding modes Pro^{OE}

- » The availability of the riding modes depends on the custom configuration of the riding modes preselection function.◀
- » With the motorcycle at a standstill, the selected

mode is activated after approximately 2 seconds.

- » The following conditions must be satisfied for activation of a new riding mode while riding:
 - Throttle grip is in idle position.
 - Brake is not applied.
 - Cruise control is deactivated.
- » The selected riding mode is retained with the engine-characteristic, ABS, ASC/DTC and Dynamic ESA adaptation settings even after the ignition has been switched off.

RIDING MODE PRO

–with riding modes Pro^{OE}

Adjustment option

The PRO riding modes can be set individually.

Configuring DYNAMIC PRO riding mode

- Switch on the ignition (▮▮▮ 62).
- Navigate to Settings, Vehicle settings, Driving mode preselection.
- Select DYNAMIC PRO riding mode and activate.
- Select Configuration and confirm.

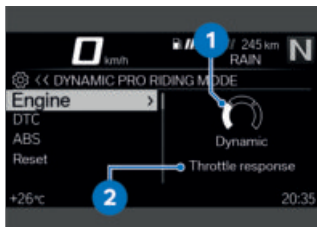

The Engine system has been selected. The current setting is displayed as a diagram **1** with explanatory texts relating to the system **2**.

- Select system and confirm.



You can browse through the available settings **3** and the corresponding explanations **4**.

- Set up the system.
 - » The Engine, DTC and ABS systems can be set up in the same way.
- The settings can be reset to the factory settings:
 - Resetting riding mode settings (▮▮▮ 82).

82 OPERATION

Resetting riding mode settings

- Configure DYNAMIC PRO riding mode (➔ 81).
- Select Reset and confirm.
» The following factory settings apply for DYNAMIC PRO riding mode:
 - DTC: DYNAMIC PRO
 - ABS: DYNAMIC
 - Engine: DYNAMIC

CRUISE CONTROL

-with cruise control^{OE}

Display when adjusting settings (Speed Limit Info not active)



The symbol **1** for cruise control is displayed in the Pure Ride view and the top status line.

Display when adjusting settings (Speed Limit Info active)



The symbol **1** for cruise control is displayed in the Pure Ride view and the top status line.

Switching on cruise control



- Slide switch **1** to the right.
» Button **2** is operational.

Setting road speed



- Short-push button **1** forward.



Adjustment range for
cruise control

30...210 km/h



Indicator light for cruise
control comes on.

- » The motorcycle maintains your current cruising speed and the setting is saved.

Accelerating



- Short-push button **1** forward.
- » Speed is increased by approx. 1 km/h each time you push the button.
- Push button **1** forward and hold it in this position.

- » The vehicle accelerates smoothly.
- » The current speed is maintained and saved if button **1** is not pushed again.

Decelerating



- Short-push button **1** back.
- » Speed is reduced by 1 km/h each time you push the button.
- Push button **1** back and hold it in this position.
- » The vehicle decelerates smoothly.
- » The current speed is maintained and saved if button **1** is not pushed again.

Deactivating cruise control

- Brake, pull the clutch lever or turn the throttle grip (close the throttle by turning the grip back past the idle position) to deactivate cruise control.
- » Indicator light for cruise control goes out.

84 OPERATION

Resuming former cruising speed



- Short-push button **1** back to return to the speed saved beforehand.

 Opening the throttle does not deactivate cruise control. When the twistgrip is released the motorcycle decelerates only to the speed saved in memory, even if the rider intended slowing to a lower speed.

 Indicator light for cruise control comes on.

Switching off cruise control

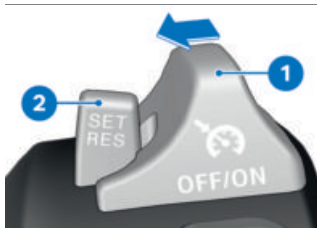

- Slide switch **1** to the left.
» The system is deactivated.

» Button **2** is disabled.

LAPTIMER

–with riding modes Pro^{OE}

Starting timing

- Call up the **Sport** menu and switch to the **Sport 2** display.
- Start the engine (➔ 130).



- Press button **1**.
» Time recording is running.
- Every time you cross the start/finish line, press button **1** again to start recording for the next lap.
» The data of the preceding lap are written into memory.
» The time for the current lap starts again from 00:00:00.
» The stopped time for a lap is displayed for an adjustable **Disp. duration time** before the display switches to elapsed time for the current lap.
» Recording continues even if you exit the display mode during recording.

Ending time recording and managing times

Requirement

The Sport 2 display is displayed.

- Press down the MENU rocker button.
- » The LAPTIMER menu is displayed.
- Timing in progress can be ended with Stop recording.
- You can go to the current lap times and riding data by using Laps. 99 laps can be saved. If the laps have not been deleted in the meantime, additional laps overwrite the first laps.
- All laps can be deleted with Delete all laps.
- You can use Reset Best Ever to reset the all-time best lap (Best Ever).

Adjusting the lap timer

- Navigate to Settings, Vehicle settings, Laptimer.
- » The following settings are available:
- Debounce time: If the headlight flasher has been actuated, the headlight flasher can be actuated again within this time without affecting lap time measurement.

- Disp. duration: Within this time, the stopped lap time is displayed before the current lap time is shown.
- Reference: Selection of which best time is displayed as a reference. Best: Best time of the current recording or Best Ever: Best-ever measured time.
- Best lap in progress: When this function is activated, the difference between the current lap time and the reference time is displayed instead of the difference between the last lap time and the reference time.

Best-ever lap

The best-ever lap (Best Ever) is the fastest of all recorded laps and is updated once a faster lap has been recorded. The best-ever lap remains stored in memory even if the recorded laps are deleted. This means that other races can subsequently be timed and the lap times of those races compared with the best-ever lap from earlier races. The best-ever lap can be deleted in the LAPTIMER menu. If the best-ever lap is from a saved recording, it is accompanied on the display by the

86 OPERATION

relevant lap number. If the best-ever lap shows without a lap number, this means that it comes from a recording that has been deleted.

SHIFT LIGHT

–with riding modes Pro^{OE}

Switching shift light on and off



- Navigate to Settings, Vehicle settings.
- Switch Shift light on or off.

Setting shift light

- Switch on the Shift light function.
- Navigate to Settings, Vehicle settings, Configuration (under Shift light).
- » The following settings are available:
 - Start RPM
 - End RPM
 - Brightness

–Frequency. A flashing frequency of 0 Hz corresponds to steady light.

- » Changes to brightness and the flashing frequency are demonstrated by the shift light with it briefly lighting up or flashing.

ANTI-THEFT ALARM (DWA)

Activation

–with anti-theft alarm (DWA)^{OE}

- Switch on the ignition (➡ 62).
- Customise the anti-theft alarm settings (➡ 89).
- Switch off the ignition.
- » If the alarm system is activated, then the alarm system will be automatically activated when the ignition is switched off.
- » Activation takes approximately 30 seconds to complete.
- » Turn indicators flash twice.
- » Confirmation tone sounds twice (if programmed).
- » Anti-theft alarm is active.

–with Keyless Ride^{OE}

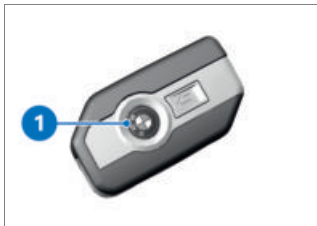

- Switch off the ignition.
- Press button **1** on the radio-operated key twice.
 - » Activation takes approximately 30 seconds to complete.
 - » Turn indicators flash twice.
 - » Confirmation tone sounds twice (if programmed).
 - » Anti-theft alarm is active.

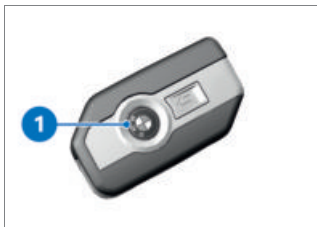

- To deactivate the motion sensor (for example if you are about to transport the motorcycle on a train and the swaying movement of the moving train could trip the alarm), press button **1** on the radio-

operated key again during the activation phase.

- » Turn indicators flash three times.
- » Confirmation tone sounds three times (if programmed).
- » Motion sensor has been deactivated.◀

Alarm signal

–with anti-theft alarm (DWA)^{OE}

A DWA alarm can be triggered by:

- Motion sensor
- Switch-on attempt with an unauthorised vehicle key.
- Disconnection of the DWA anti-theft alarm from the motorcycle's battery (DWA internal battery in the anti-theft alarm provides power - acoustic alarm only, the turn indicators do not flash)

–with Keyless Ride^{OE}

 When the radio-operated key is within range, an alarm triggered by the tilt sensor is suppressed.◀

All functions are sustained even if the internal battery of the DWA anti-theft alarm system is flat; the only difference is that an alarm cannot be triggered if the system is disconnected from the motorcycle's battery.

88 OPERATION

An alarm lasts for approximately 26 seconds. While an alarm is in progress an alarm tone sounds and the turn indicators flash. The type of acoustic alarm tone can be set by an authorised BMW Motorrad retailer.

–with Keyless Ride^{OE}



You can cancel an alarm at any time by pressing button **2** on the radio-operated key; this does not deactivate the alarm system.

If an alarm was triggered while the motorcycle was unattended, the rider is notified accordingly by an alarm tone sounding once when the ignition is switched on. The DWA LED then indicates the reason for the alarm for one minute.

Light signals issued by the DWA LED:

- Flashes 1x: Motion sensor 1
- Flashes 2x: Motion sensor 2
- Flashes 3x: Ignition switched on with unauthorised vehicle key
- Flashes 4x: Disconnection of the anti-theft alarm from the vehicle's battery
- Flashes 5x: Motion sensor 3

Deactivation

–with anti-theft alarm (DWA)^{OE}

- Switch on the ignition (▣▣▣▶ 62).
 - » Turn indicators flash once.
 - » Confirmation tone sounds once (if programmed).
 - » DWA has been switched off.
- with Keyless Ride^{OE}



- Press button **2** on the radio-operated key once.

 When the alarm function is deactivated with the radio-operated key and the ignition is not subsequently switched on, the alarm function is automatically re-activ-

ated after approx. 30 seconds if "Activation after ignition off" is programmed.

- » Turn indicators flash once.
- » Confirmation tone sounds once (if programmed).
- » DWA has been switched off.◀

Customising anti-theft alarm settings

- Switch on the ignition (▣▶ 62).
- Navigate to *Settings*, *Vehicle settings*, *Alarm system*.
- » The following settings are available:
 - Adapt Warning signal
 - Switch Tilt sensor on and off
 - Switch Arming tone on and off
 - Switch Arm automatically on and off
 - with anti-theft alarm (DWA)^{OE}
 - » Possibilities for adjustment (▣▶ 89)◀

Possibilities for adjustment

– with anti-theft alarm (DWA)^{OE}

Warning signal: Set the increasing and decreasing or intermittent alarm tone.

Tilt sensor: Activate tilt sensor to monitor the inclination of the vehicle. The anti-theft alarm is tripped if any attempt is made to steal a wheel

or lift the vehicle for towing, for example.



When the vehicle is going to be transported, deactivate the tilt sensor to prevent the anti-theft alarm (DWA) from being triggered.

Arming tone: In addition to turn indicators flashing, alarm tone sounds as confirmation of activation/deactivation of the DWA.

Arm automatically: Automatic activation of the alarm function when the ignition is switched off.

TYRE PRESSURE CONTROL (RDC)

– with tyre pressure control (RDC)^{OE}

Switching specified-pressure warning on or off

- The system can be set to issue a specified-pressure warning when tyre pressure drops to the defined minimum.
- Navigate to *Settings*, *Vehicle settings*, *RDC*.
- Switch *Target pressure warn. on or off*.



- Use the ignition key to turn seat lock **1** counter-clockwise.
» Seat bench is unlocked.

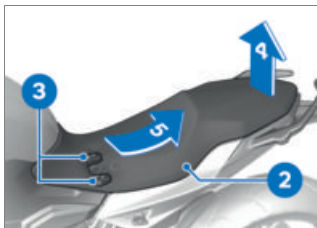

- Slightly raise seat **2** in direction of arrow **4**.
- Work seat **2** in direction of arrow **5** to disengage it from holder **3**.
- Lay seat **2** on a clean surface.

Installing seat



- Work seat **2** in direction of arrow **4** to engage it in holders **3**.
- Press seat bench firmly in direction of arrow **5**.
» The seat bench audibly engages.

TFT DISPLAY

05

GENERAL NOTES	94
PRINCIPLE	95
PURE RIDE VIEW	101
GENERAL SETTINGS	102
BLUETOOTH	104
MY VEHICLE	107
ON-BOARD COMPUTER	110
NAVIGATION	110
MEDIA	112
TELEPHONE	113
DISPLAY SOFTWARE VERSION	114
DISPLAY LICENCE INFORMATION	114

GENERAL NOTES

Warnings



WARNING

Using a smartphone while riding or while the engine is running

Risk of accident

- Always comply with the road traffic regulations in force where you are riding.
- No use (with the exception of applications without operation, such as hands-free telephony) while riding.



WARNING

Distraction from the road and loss of control

Operating the integrated information system and communication devices while driving results in a risk of accident

- Operate those systems or devices only when the traffic situation allows for it.
- If necessary, stop and operate the systems or devices when stationary.

Connectivity functions

Connectivity functions include media, telephony and navigation. Connectivity functions can be used when the TFT display is paired with a mobile end device and a helmet (104). For more information on the Connectivity functions go to: **bmw-motorrad.com/connectivity**



If the fuel tank is between the mobile device and the TFT display, the Bluetooth connection may be restricted. BMW Motorrad recommends storing the device above the fuel tank (e.g. in your jacket pocket).



Depending on the mobile device, the scope of the Connectivity functions may be restricted.

BMW Motorrad Connected app

The BMW Motorrad Connected app contains usage and vehicle information. For some functions, such as navigation, the app must be installed on the mobile device and connected to the TFT display. The app is used to start route guidance and adjust the navigation.

 On some mobile devices, e.g. those with iOS operating systems, the BMW Motorrad Connected App must be opened before use.

Currency

The TFT display may be updated after the publication date. Because of this, your motorcycle may differ from the information supplied in the Rider's Manual. Up-to-date information is available at: bmw-motorrad.com/service

PRINCIPLE

Controls

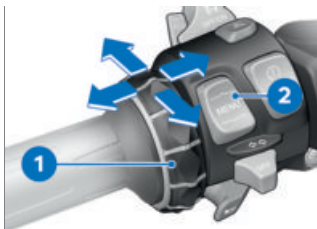

All display content is controlled by means of Multi-Controller **1** and MENU rocker button **2**. Depending on the context, the following functions are possible.

Multi-Controller functions

Turn the Multi-Controller up:

- Move the cursor up in lists.
- Adjust settings.
- Increase volume.

Turn the Multi-Controller down:

- Move the cursor down in lists.
- Adjust settings.
- Decrease volume.

Tilt the Multi-Controller to the left:

- Activate the function appropriate to the Check Control messages.
- Activate the function to the left or back.
- Go back to the Menu view after making the settings.
- In Menu view: Change up one level.
- In the My Vehicle menu: advance one menu screen.

Tilt the Multi-Controller to the right:

- Confirm selection.
- Confirm settings.
- Advance a menu step.
- Scroll to the right in lists.
- In the My Vehicle menu: advance one menu screen.

96 TFT DISPLAY

MENU rocker button functions

 Instructions given by the navigation system are displayed in a dialogue box if the Navigation menu has not been called up. Operation of the MENU rocker button is temporarily restricted.

Short-press the top section of the MENU button:

- In Menu view: Change up one level.
- In Pure Ride view: Change the display for status line.

Long-press the top section of the MENU button:

- In Menu view: Call up Pure Ride view.
- In Pure Ride view: Change operating focus to the Navigator.

Short-press the bottom section of the MENU button:

- Change down a level.
- No function if the lowest hierarchical level has been reached.

Long-press the bottom section of the MENU button:

- Change back to the last menu after a previous menu change effected by long-pressing the top section of the MENU rocker button.

Operating pointers in the main menu

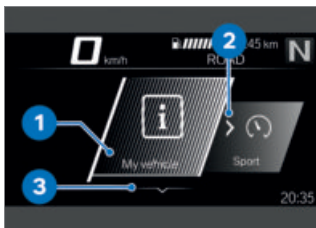

Operating pointers show whether interactions are possible, and which ones.



Meaning of the operating pointers:

- Operating pointer 1: Left end reached.
- Operating pointer 2: You can scroll to the right.
- Operating pointer 3: You can scroll down.
- Operating pointer 4: You can scroll to the left.
- Operating pointer 5: Right end reached.

Operating pointers in submenus

In addition to the operating pointers in the main menu, there are additional operating pointers in the submenus.

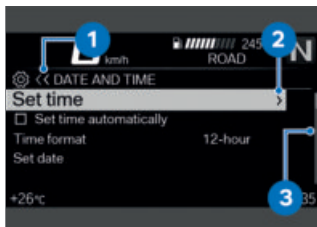

Meaning of the operating pointers:

- Operating pointer **1**: The current display is in a hierarchical menu. The number of symbols indicates up to three submenu levels. The colour of the symbol changes, depending on whether you can return to a higher level.
- Operating pointer **2**: One more submenu level can be accessed.
- Operating pointer **3**: There are more entries than can be displayed.

Display Pure Ride view

- Long-press the top section of the MENU rocker button.

Switching functions on and off

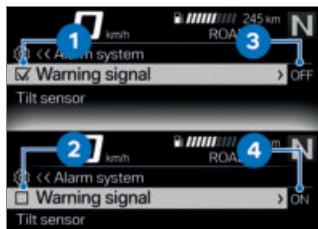

Some menu items have a check box in front of them. The check box shows whether the function is on or off. Action symbols after the menu items indicate what action you can trigger by short-tilting the Multi-Controller to the right.

Examples for switching on and off:

- Symbol **1** shows that the function is switched on.
- Symbol **2** shows that the function is switched off.
- Symbol **3** shows that the function can be switched off.
- Symbol **4** shows that the function can be switched on.

98 TFT DISPLAY

Calling up menu

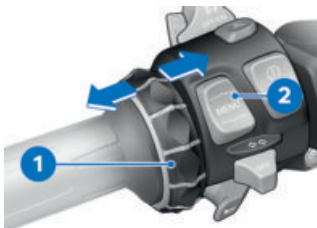

- Display Pure Ride view (▮▮▮▮ 97).
- Short-press the bottom section of button **2**.

The following menus can be called up:

- My vehicle
- Navigation
- Media
- Telephone
- Settings

- Repeatedly short-push Multi-Controller **1** to the right until the menu item you want is highlighted.
- Short-press the bottom section of button **2**.

 The Settings menu can only be called up when the vehicle is stationary.

Moving cursor in lists

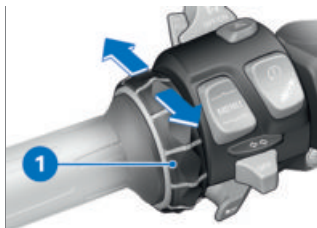

- Call up the menu (▮▮▮▮ 98).
- To move the cursor down in a list, turn Multi-Controller **1** down until the entry you want is highlighted.
- To move the cursor up in a list, turn Multi-Controller **1** up until the entry you want is highlighted.

Confirming selection

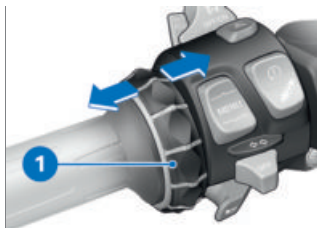

- Select the desired entry.
- Short-push Multi-Controller **1** to the right.

Call up the last menu used

- In Pure Ride view: press and hold the MENU rocker button.
- » The last menu used is called up. The last entry highlighted is selected.

Change of operating focus

–with preparation for navigation system^{OE}

If the Navigator is connected, it is possible to switch between operation of the Navigator and the TFT display.

Changing operating focus

–with preparation for navigation system^{OE}

- Secure the navigation device (▮▮▮▮▶ 205).
- Display Pure Ride view (▮▮▮▮▶ 97).
- Long-press the top section of the MENU rocker button.
- » Operating focus switches to the Navigator or the TFT display, as applicable. The active device is highlighted on the left in the top status line. Operator actions affect the currently active device until the operating focus is changed again.
- » Operating navigation system (▮▮▮▮▶ 206)

System status displays

The system status is displayed in the lower area of the menu if a function is switched on or off.

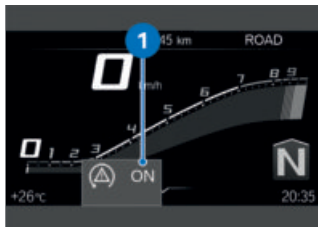

Example of what the system statuses mean:

–System status 1: ASC/DTC function is switched on.

Changing display for status line

Requirement

The vehicle is at a standstill. The Pure Ride view is displayed.

- Switch on the ignition (▮▮▮▮▶ 62).
- » The TFT display shows all the information necessary for riding on public roads from the on-board computer (e.g. TRIP 1) and the trip computer (e.g. TRIP 2). The information can be displayed in the top status line.

100 TFT DISPLAY

–with tyre pressure control (RDC)^{OE}





» Information from the tyre pressure control can also be displayed.◁

- Select the content of the status line (▶▶ 100).



- Long-press button **1** to obtain the Pure Ride view.
- Repeatedly short-press button **1** to select the value in the top status line **2**.

The following values can be displayed:

-  Total distance
-  Current distance 1
-  Current distance 2
-  Consumption 1 (Average)
-  Consumption 2 (Average)

 Riding time 1

 Riding time 2

 Break 1

 Break 2

 Speed 1 (Average)

 Speed 2 (Average)

–with tyre pressure control (RDC)^{OE}

 Tyre pressure◁

 Fuel tank level

 Range

Selecting content of status line

- Navigate to Settings, Display, Status line content.
- Switch on the desired displays.
- » You can switch between the selected displays in the status line. If no displays are selected, only the range will be displayed.

Adjust settings

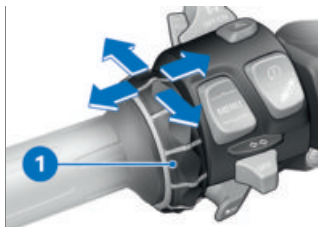

- Select and confirm the desired settings menu.
 - Turn Multi-Controller **1** down until the setting you want is highlighted.
 - If an operating pointer shows, tilt Multi-Controller **1** to the right.
 - If no operating pointer shows, tilt Multi-Controller **1** to the left.
- » The setting is saved.

Switching Speed Limit Info on or off

Requirement

Vehicle is connected with a compatible mobile device. The BMW Motorrad Connected app is installed on the mobile device.

- Speed Limit Info shows the maximum speed permitted at the time, if this information is made available by the publisher of the map material in the navigation system.

- Navigate to Settings, Display.
- Switch Speed Limit Info on or off.

PURE RIDE VIEW

Rev. counter



- 1 Scale
- 2 Low engine speed range
- 3 Upper/red engine speed range
- 4 Needle
- 5 Secondary indicator
- 6 Unit for engine speed display:
1000 revolutions per minute

102 TFT DISPLAY

Range



The range readout **1** indicates how far you can ride with the fuel remaining in the tank. This distance is calculated on the basis of average consumption and the quantity of fuel on board.

- When the vehicle is propped on its side stand the slight angle of inclination means that the sensor cannot register the fuel level correctly. This is the reason why the range is recalculated only when the side stand is in the retracted position.
- The range is shown together with a warning once the fuel reserve has been reached.
- After a refuelling stop, range is recalculated if the amount of fuel in the tank is greater than the reserve quantity.
- The calculated range is only an approximate figure.

Recommendation to upshift



The recommendation to upshift in **1** view **2** or in status line indicates the best time to upshift to conserve fuel.

GENERAL SETTINGS

Adjusting volume

- Connect rider's and passenger's helmet (▣▣▣ 106).
- Increase volume: turn the multi-controller upwards.
- Decrease volume: turn the multi-controller downwards.
- Mute: turn the multi-controller all the way down.

Setting the date

- Switch on the ignition (▣▣▣ 62).
- Navigate to Settings, System settings, Date and time, Set date.
- Set Day, Month and Year.
- Confirm setting.

Set date format

- Navigate to Settings, System settings, Date and time, Date format.
- Select the desired setting.
- Confirm setting.

Setting clock

- Switch on the ignition (▣▣▣ 62).
- Navigate to Settings, System settings, Date and time, Set time.
- Set Hour and Minute.

Setting time format

- Navigate to Settings, System settings, Date and time, Time format.
- Select the desired setting.
- Confirm setting.

Setting units of measurement

- Navigate to Settings, System settings, Units.

The following units of measurement can be set:

- Speed
- Consumption
- with tyre pressure control (RDC)^{OE}
- Pressure◀
- Temperature

Setting language

- Navigate to Settings, System settings, Language.

The following languages can be set:

- German

- English (UK)
- English (US)
- Spanish
- French
- Italian
- Dutch
- Polish
- Portuguese
- Turkish
- Russian
- Ukrainian
- Chinese
- Japanese
- Korean
- Thai

Adjusting brightness

- Navigate to Settings, Display, Brightness.
- Adjust display brightness.
 - » When ambient brightness drops below a defined threshold, the display is dimmed to the brightness set here.

Resetting all settings

- All the settings in the Settings menu can be reset to the factory settings.
- Call up the Settings menu.
- Select Reset all and confirm.

The settings in the following menus are reset:

- Vehicle settings
- System settings
- Connections
- Display

104 TFT DISPLAY

-Information

» Existing Bluetooth connections are not deleted.

BLUETOOTH

Short-range wireless technology

Bluetooth is a short-range wireless technology. Bluetooth devices are short-range devices transmitting on the license-free ISM band (Industrial, Scientific, Medical) between 2.402 GHz and 2.480 GHz. They can be operated anywhere in the world without a licence being required.

Although Bluetooth is designed to establish and sustain robust connections over short distances, as with every other wireless technology disruptions are possible. Interference can affect connections or connections can sometimes fail. Particularly when multiple devices operate in a Bluetooth network, with wireless technology of this nature it is not possible to ensure fault-free communications in every situation.

Possible sources of interference:

- interference zones due to transmission masts and similar.
- devices with non-compliant Bluetooth implementations.
- proximity of other Bluetooth-compatible devices.

Pairing

Two Bluetooth devices have to recognise each other before they can communicate. This process of mutual recognition is known as pairing. When two devices have paired they remember each other, so the pairing process is conducted only once, on initial contact.

 On some mobile devices, e.g. those with iOS operating systems, the BMW Motorrad Connected App must be opened before use.

During the pairing process, the TFT display searches for other Bluetooth-compatible devices within its reception range. The conditions that have to be satisfied before the audio system can recognise another device are as follows:

- The device's Bluetooth function must be active
- The device must be "visible" to others
- The device must support the A2DP profile
- Other Bluetooth-compatible devices must be OFF (e.g. mobile phones and navigation systems).

Please consult the operating instructions for your communication system.

Pairing

- Call up the **Settings, Connections** menu.
- » Bluetooth connections can be established, managed and deleted in the **CONNECTIONS** menu. The following Bluetooth connections are displayed:

- Mobile device
- Rider's helmet
- Passenger helm.

The connection status for mobile devices is displayed.

Connect mobile device

- Pairing (▶▶▶ 105).
- Activate the mobile device's Bluetooth function (see mobile device's operating instructions).
- Select **Mobile device** and confirm.

- Select **Pair new mobile device** and confirm.

Mobile devices are being searched for.



The Bluetooth symbol flashes in the bottom status line during pairing.

Mobile devices found are displayed.

- Select and confirm mobile device.
- Follow the instructions on the mobile device.
- Confirm that the code matches.
- » The connection is established and the connection status updated.
- » If the connection is not established, consult the troubleshooting chart in the section entitled "Technical data". (▶▶▶ 218)
- » Depending on the mobile device, telephone data is transferred to the vehicle automatically.
- » Telephone data (▶▶▶ 114)
- » If the telephone book is not displayed, consult the troubleshooting chart in the section entitled "Technical data". (▶▶▶ 219)
- » If the Bluetooth connection does not work as expected, consult the troubleshooting

106 TFT DISPLAY

chart in the section entitled "Technical data". (▶▶▶ 219)

Connect rider's and passenger's helmet

- Pairing (▶▶▶ 105).
- Select Rider's helmet or Passenger helm. and confirm.
- Make the helmet's communication system visible.
- Select Pair new rider's helmet or Pair new passeng. helmet and confirm.

Helmets are searched for.



The Bluetooth symbol flashes in the bottom status line during pairing.

Helmets found are displayed.

- Select and confirm helmet.
- » The connection is established and the connection status updated.
- » If the connection is not established, consult the troubleshooting chart in the section entitled "Technical data". (▶▶▶ 218)
- » If the Bluetooth connection does not work as expected, consult the troubleshooting chart in the section entitled "Technical data". (▶▶▶ 219)

Deleting connections

- Call up the Settings, Connections menu.
- Select Delete connections.
- To delete an individual connection, select the connection and confirm.
- To delete all connections, select Delete all connections and confirm.

MY VEHICLE

Start screen

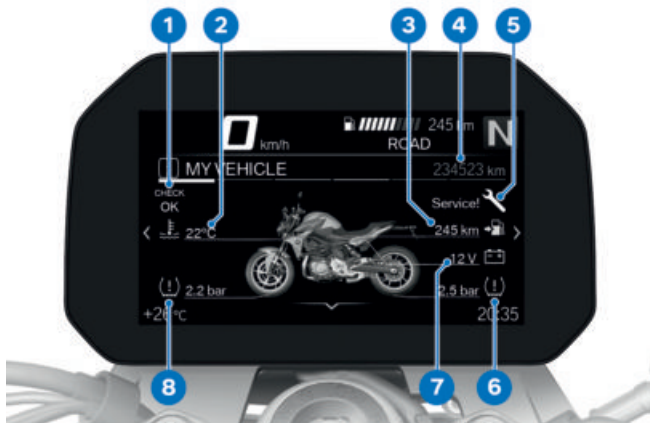

- 1 Check Control display
(⇒ 33)
- 2 Coolant temperature
(⇒ 45)
- 3 Range (⇒ 102)
- 4 Odometer
- 5 Service display (⇒ 57)
- 6 Tyre pressure, rear
(⇒ 175)
- 7 On-board voltage
(⇒ 191)
- 8 Tyre pressure, front
(⇒ 175)

108 TFT DISPLAY

Operating pointers

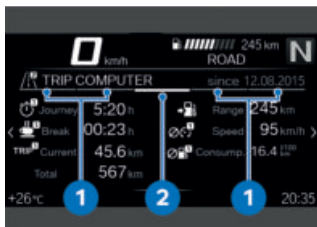

- Operating pointer 1: Indicators showing how far you can scroll to the left or right.
- Operating pointer 2: Indicator showing the position of the current menu screen.

Scrolling through menu screens

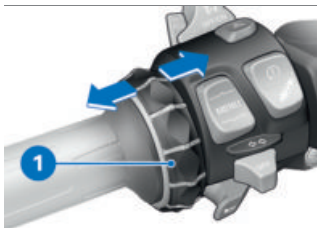

- Call up the My vehicle menu.
- To scroll to the right, short-press Multi-Controller 1 to the right.
- To scroll to the left, short press Multi-Controller 1 to the left.

The My Vehicle menu contains the following screens:

- MY VEHICLE
- ON-BOARD COMPUTER
- TRIP COMPUTER
- with tyre pressure control (RDC) OE
- TYRE PRESSURE◀
- SERVICE REQUIREMENTS
- CC MESSAGE (if available)
- For more information on tyre pressures and Check Control messages, see the section on displays (▶▶ 33).
- Check Control messages are attached dynamically to the menu screens as additional tabs in the My vehicle menu.

On-board computer and trip computer

The ON-BOARD COMPUTER and TRIP COMPUTER menu screens display vehicle and trip data, such as average values.

Service requirements

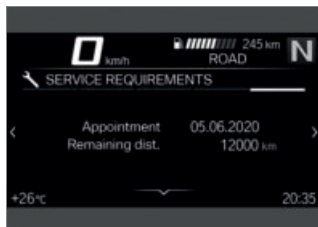

When the next service is due within less than a month or within 1000 km, a white Check Control message is displayed.

110 TFT DISPLAY

ON-BOARD COMPUTER

Calling up on-board computer

- Call up the My vehicle menu.
- Scroll to the right until the ON-BOARD COMPUTER menu screen is displayed.

Resetting on-board computer

- Call up the on-board computer (▣▶▶ 110).
- Press down the MENU rocker button.
- Select Reset all values or Reset individual values and confirm.

The following values can be reset:

- Break
- Journey
- Current (TRIP 1)
- Speed
- Consump.

Calling up trip computer

- Call up the on-board computer (▣▶▶ 110).
- Scroll to the right until the TRIP COMPUTER menu screen is displayed.

Resetting trip computer

- Call up the trip computer (▣▶▶ 110).
- Press down the MENU rocker button.

- Select Autom. reset or Reset all values and confirm.
 - » If Autom. reset is selected, the trip computer is automatically reset when a minimum of 6 hours have passed and the date has changed since the ignition was switched off.

NAVIGATION

Warnings



WARNING

Using a smartphone while riding or while the engine is running

Risk of accident

- Always comply with the road traffic regulations in force where you are riding.
- No use (with the exception of applications without operation, such as hands-free telephony) while riding.



WARNING

Distraction from the road and loss of control

Operating the integrated information system and communication devices while driving results in a risk of accident

- Operate those systems or devices only when the traffic situation allows for it.
- If necessary, stop and operate the systems or devices when stationary.

Precondition

The vehicle is connected via Bluetooth to a compatible mobile device.

The BMW Motorrad Connected app is installed on the connected mobile device.



On some mobile devices, e.g. those with iOS operating systems, the BMW Motorrad Connected App must be opened before use.

Entering destination address

- Connect mobile device (▶▶▶▶ 105).
- Call up the BMW Motorrad Connected app and start the route guidance.

- Call up the Navigation menu in the TFT display.
- » Active route guidance is displayed.
- » If active route guidance is not displayed, consult the troubleshooting chart in the section entitled "Technical data". (▶▶▶▶ 219)

Selecting destination from recent destinations

- Call up the Navigation, Recent destinations menu.
- Select and confirm destination.
- Select Start route guidance.

Selecting destination from favourites

- The FAVOURITES menu displays all the destinations saved as favourites in the BMW Motorrad Connected app. You cannot use the TFT display to add favourites to the list.
- Navigate to Navigation, Favourites.
- Select and confirm destination.
- Select Start guidance.

Control music playback

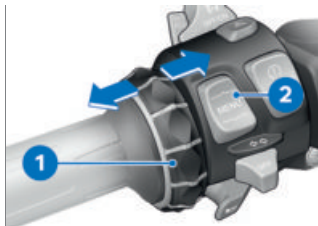

- Call up the **Media** menu.

 BMW Motorrad recommends setting the volume on the mobile end device for media and calls to maximum before setting off.

- Adjust the volume (▬▶▶ 102).
- Next track: Short-tilt Multi-Controller **1** to the right.
- Last track or start of the current track: Short-tilt Multi-Controller **1** to the left.
- Fast forward: Long-tilt Multi-Controller **1** to the right.
- Rewind: Long-tilt Multi-Controller **1** to the left.
- Call up context menu: Press bottom part of button **2**.

 Depending on the mobile device, the scope of the Connectivity functions may be restricted.

- » The following functions can be used in the context menu:
- Playback or Pause.

- Select the **Now playing**, **All artists**, **All albums** or **All tracks** category for search and playback.
- Select **Playlists**.

You can make the following adjustments in the **Audio settings** submenu:

- Switch **Shuffle** on or off.
- Select **Repeat: Off**, **One (current track)** or **All**.

TELEPHONE

Precondition

The vehicle is connected to a compatible mobile device and helmet.

Telephone calls

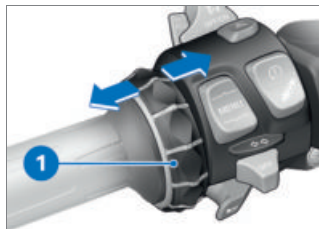

- Call up the **Telephone** menu.
- Accept call: Tilt Multi-Controller **1** to the right.
- Reject call: Tilt Multi-Controller **1** to the left.
- End call: Tilt Multi-Controller **1** to the left.

ADJUSTMENT

06

MIRRORS	118
HEADLIGHT	118
CLUTCH	119
BRAKES	120
SPRING PRELOAD	120
DAMPING	121

118 ADJUSTMENT

MIRRORS

Adjusting mirrors



- Turn the mirror to the appropriate position.

Adjusting mirror arm



- Push protective cap **1** over the threaded fastener of the mirror arm up to expose the threaded fastener.
- Slacken nut **2**.
- Turn the mirror arm to the appropriate position.
- Tighten the nut to the specified torque, while holding the mirror arm to ensure that it does not move out of position.



Mirror (locknut) to clamping piece

M10 x 1.25

22 Nm (Left-hand thread)

- Push the protective cap over the threaded fastener.

HEADLIGHT

Headlight beam throw and spring preload

Headlight beam throw is generally kept constant when spring preload is adjusted to suit load.

Spring preload adjustment might not suffice only if the motorcycle is very heavily loaded. Under these circumstances, headlight beam throw has to be adjusted to suit the weight carried by the motorcycle.



If there are doubts about the correct headlight beam throw, have the setting checked by a specialist workshop, preferably an authorised BMW Motorrad dealer.

Adjusting headlight beam throw

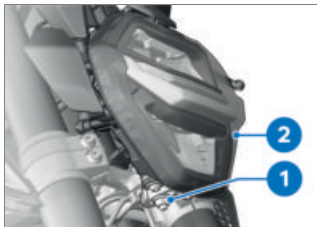

If, for a high load, the adjustment of the spring pre-load is no longer sufficient not to dazzle oncoming traffic:

- Use adjusting screws **1** on left and right to adjust beam throw for both headlights.

When the motorcycle is again ridden with a lower load:

- Return the headlight to its basic setting.
- Slacken nut **1**.
- Adjust beam throw by tilting headlight **2** slightly about its horizontal axis.
- Tighten nut **1**.

CLUTCH

Adjusting clutch lever



WARNING

Adjusting the clutch lever while riding

Risk of accident

- Adjust the clutch lever only when the motorcycle is at a standstill.



- Turn adjusting screw **1** clockwise to increase the span between the clutch lever and the handlebar grip.
- Turn adjusting screw **1** anti-clockwise to reduce the span between the clutch lever and the handlebar grip.



The adjusting screw can be turned more easily if the clutch lever is pushed forward.

120 ADJUSTMENT

BRAKES

Adjusting brake lever

WARNING

Relocated brake fluid tank

Air in the brake system

- Do not turn the handlebars or the handlebar fitting on the handlebar.

WARNING

Adjusting the handbrake lever while riding

Risk of accident

- Do not attempt to adjust the handbrake lever unless the motorcycle is at a standstill.



- Turn adjusting screw **1** anticlockwise to increase the span between the brake lever and the handlebar grip.
- Turn adjusting screw **1** clockwise to reduce the span between the brake lever and the handlebar grip.



The adjusting screw is easier to turn when the handbrake lever is pushed forward.

SPRING PRELOAD

—without Dynamic ESA^{OE}

Adjustment

It is essential to set spring preload of the rear suspension to suit the load carried by the motorcycle. Increase spring preload when the motorcycle is heavily loaded and reduce spring preload accordingly when the motorcycle is lightly loaded.

Adjusting spring preload for rear wheel

- Remove the seat (▣ 90).
- Removing the toolkit.

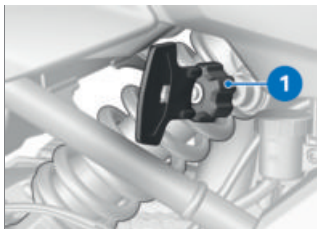
**WARNING****Spring preload setting and spring-strut damping setting not matched.**

Impaired handling.

- Adjust spring-strut damping to suit spring preload.
- If you want to increase spring preload, use the tool from the on-board toolkit to turn adjuster knob **1** clockwise.
- If you want to reduce spring preload, use the tool from the toolkit to turn adjuster knob **1** counter-clockwise.



Basic setting of spring preload, rear

Turn the adjuster knob as far as it will go counter-clockwise. (One-up riding without luggage)



Basic setting of spring preload, rear

Turn the adjuster as far as it will go counter-clockwise, then back it off 20 turns in the clockwise direction. (One-up with luggage)

Turn the knob clockwise as far as it will go. (Two-up with luggage)

- Stow the on-board toolkit in its correct position.
- Install the seat (▮▮▮ 91).

DAMPING

—without Dynamic ESA^{OE}

Adjustment

Damping must be adapted to suit the condition of the surface on which the motorcycle is ridden and to suit spring preload.

- An uneven surface requires softer damping than a smooth surface.
- An increase in spring preload requires firmer damping, a reduction in spring preload requires softer damping.

Adjusting damping for rear wheel

- Make sure the ground is level and firm and place the motorcycle on its stand.

122 ADJUSTMENT

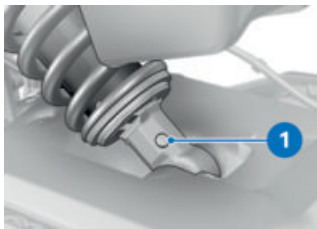

- Adjust the damping action by turning adjusting screw **1**.

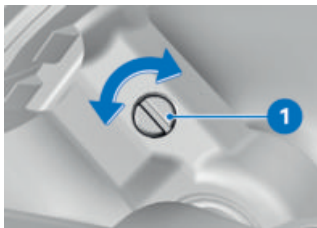

- Turn the adjusting screw **1** clockwise to harden the damping action.
- Turn the adjusting screw **1** anticlockwise to soften the damping action.

 Basic setting of rear-suspension damping characteristic

Turn the adjusting screw clockwise to the limit position, and then 0.5 turns anticlockwise. (One-up with luggage)

Turn the adjusting screw as far as it will go clockwise, then back it off 0.25 of a turn. (Two-up with luggage)

 Basic setting of rear-suspension damping characteristic

Turn the adjusting screw as far as it will go clockwise, then back it off 1.5 turns. (One-up riding without luggage)

RIDING

07

SAFETY INFORMATION	126
REGULAR CHECK	129
STARTING	130
RUNNING IN	134
SHIFTING GEAR	135
SHIFT LIGHT	136
BRAKES	136
PARKING YOUR MOTORCYCLE	138
REFUELLING	139
SECURING MOTORCYCLE FOR TRANSPORTATION	144

SAFETY INFORMATION

Rider's equipment

Do not ride without the correct clothing! Always wear

- Helmet
- Suit
- Gloves
- Boots

This applies even to short journeys, and to every season of the year. Your authorised BMW Motorrad retailer will be happy to advise you on the correct clothing for every purpose.



WARNING

Loose textiles, items of luggage or straps snagged by open rotating parts of the vehicle (wheels, drive shaft)

Risk of accident

- Make sure that loosely worn or carried textiles cannot be snagged by openly rotating parts of the vehicle.
- Keep all items of luggage and straps well clear of openly rotating parts of the vehicle.

Restricted angle of heel

—with low-slung^{OE}

A motorcycle with lowered suspension has less ground clearance and cannot corner at bank angles as extreme as those achievable by a counterpart motorcycle with standard-height suspension (see the section entitled "Technical data").



WARNING

When a motorcycle with lowered suspension is cornering, certain components can come into contact with the surface at a bank angle less than that to which the rider is accustomed.

Risk of falling

- Carefully try out the limits of the motorcycle's bank angle and adapt your style of riding accordingly.

Test your motorcycle's angle of heel in situations that do not involve risk. When riding over kerbs and similar obstacles, bear in mind that your motorcycle's ground clearance is limited.

Lowering the motorcycle's suspension shortens suspension travel. Ride comfort might be restricted as a result. Be sure to adjust spring preload accordingly, particularly for riding two-up.

Loading correctly



WARNING

Handling adversely affected by overloading and imbalanced loads

Risk of falling

- Do not exceed the permissible gross weight and be sure to comply with the instructions on loading.
- Adjusting spring preload setting and damping to the total weight.
 - with case^{OA}
- Ensure that the case volumes on the left and right are equal.
- Make sure that the weight is uniformly distributed between right and left.
- Pack heavy items at the bottom of the cases and toward the inboard side.
- Note the maximum permissible payload and maximum permissible speed, see

also the section entitled "Accessories" (▶▶▶ 202).



Payload per case

max 5 kg ◀

–with topcase^{OA}

- Note the maximum permissible payload and maximum permissible speed, see also the section entitled "Accessories" (▶▶▶ 204).



Payload of topcase

max 5 kg ◀

Speed

If you ride at high speed, always bear in mind that various boundary conditions can adversely affect the handling of your motorcycle, e.g.:

- Spring-strut and shock-absorber system not set up correctly
- Imbalanced load
- Loose clothing
- Insufficient tyre pressure
- Poor tyre tread
- Added luggage systems such as cases, topcase and tank rucksack.

128 RIDING

Risk of poisoning

Exhaust fumes contain carbon monoxide, which is colourless and odourless but highly toxic.

WARNING

Exhaust gases adversely affecting health

Risk of asphyxiation

- Do not inhale exhaust fumes.
- Do not run the engine in an enclosed space.

WARNING

Inhalation of harmful vapours

Health hazard

- Do not inhale vapours from operating fluid and plastics.
- Use the vehicle only outdoors.

Risk of burning

CAUTION

Engine and exhaust system become very hot when the vehicle is in use

Risk of burn injury

- When you park the vehicle make sure that no-one and no objects can come into contact with the hot engine and exhaust system.

WARNING

Opening radiator cap

Risk of burning

- Do not open the radiator cap when the system is hot.
- Check and, if necessary, top up the coolant in the expansion tank only.

Catalytic converter

If misfiring causes unburned fuel to enter the catalytic converter, there is a danger of overheating and damage.

The following guidelines must be observed:

- Do not run the fuel tank dry
- Do not attempt to start or run the engine with a spark-plug cap disconnected
- Stop the engine immediately if it misfires

- Use only unleaded fuel
- Comply with all specified maintenance intervals.



ATTENTION

Unburned fuel in catalytic converter

Damage to catalytic converter

- Note the points listed for protection of the catalytic converter.

Risk of overheating



ATTENTION

Engine running for prolonged period with vehicle at standstill

Overheating due to insufficient cooling; in extreme cases vehicle fire

- Do not allow the engine to idle unnecessarily.
- Ride away immediately after starting the engine.

Tampering



ATTENTION

Tampering with the motorcycle (e.g. engine management ECU, throttle valves, clutch)

Damage to the affected parts, failure of safety-relevant functions, voiding of warranty

- Do not tamper with the vehicle in any way that could result in tuned performance.

REGULAR CHECK

Comply with checklist

- At regular intervals, use the checklist below to check your motorcycle.

When load status changes:

- without Dynamic ESA^{OE}
- Adjust the spring preload for rear wheel (▮▮▮ 120).
- Adjust the damping for rear wheel (▮▮▮ 121).◀

-with Dynamic ESA^{OE}

- Adjust the suspension damping (▮▮▮ 77).◀

Always before riding off:

- Check operation of the brake system.
- Check operation of the lights and signalling equipment.

130 RIDING

- Check operation of the clutch (▣▣▣ 173).
- Check the tyre tread depth (▣▣▣ 175).
- Check the tyre pressures (▣▣▣ 175).
- Check security of cases and luggage.

Every 3rd refuelling stop:

- Check the engine oil level (▣▣▣ 167).
- Check the brake pad thickness, front brakes (▣▣▣ 169).
- Check the brake pad thickness, rear brakes (▣▣▣ 170).
- Check the brake-fluid level, front brakes (▣▣▣ 171).
- Check the brake-fluid level, rear brakes (▣▣▣ 172).
- Check the coolant level (▣▣▣ 174).
- Lubricate the chain (▣▣▣ 186).
- Check the chain tension (▣▣▣ 187).

STARTING

Starting engine



ATTENTION

Sufficient gearbox lubrication only with the engine is running.

Gearbox damage

- Do not allow the motorcycle to roll for a lengthy period of time or push it a long distance with the engine switched off.
 - Switch on the ignition (▣▣▣ 62).
 - » Pre-Ride-Check is performed. (▣▣▣ 131)
 - » ABS self-diagnosis is in progress. (▣▣▣ 132)
 - » DTC self-diagnosis is in progress. (▣▣▣ 133)
 - Select neutral or, if a gear is engaged, pull the clutch lever.
-  You cannot start the motorcycle with the side stand extended and a gear engaged. The engine will switch itself off if you start it with the gearbox in neutral and then engage a gear before retracting the side stand.



- Press starter button **1**.

 The start attempt is automatically interrupted if battery voltage is too low. Recharge the battery before you start the engine, or use jump leads and a donor battery to start.

See the subsection on jump starting in "Maintenance" for more details.



The engine starts.

» If the engine refuses to start, consult the troubleshooting chart in the section entitled "Technical data". (➡ 218)

Pre-Ride-Check

The instrument cluster runs a test of the instruments and the indicator and warning lights when the ignition is switched on. This test is known as the Pre-Ride-Check. The check is aborted if you start the engine before it completes.

Phase 1

All indicator and warning lights are switched on.

After a longer vehicle stand-still period, an animation is displayed when the system starts up.

Phase 2

The 'General' warning light changes from red to yellow.

Phase 3

All the indicator and warning lights switched on in the initial phase are switched off in reverse sequence.

The malfunction indicator lamp (MIL) does not go out until 15 seconds have elapsed.

If one of the indicator and warning lights did not switch on:

- Have the fault rectified as quickly as possible by a specialist workshop, preferably an authorised BMW Motorrad retailer.



The intervention of riding dynamics control systems can be restricted, depending on which riding mode is selected and how the selected mode is configured.

Possible restrictions are indicated by a pop-up message,

132 RIDING

for example Warning! ABS & DTC setting..

See the section entitled "Engineering details" for more information on riding dynamics control systems such as ABS and ASC/DTC.

ABS self-diagnosis

BMW Motorrad ABS performs self-diagnosis to ensure its operability. Self-diagnosis starts automatically when you switch on the ignition.

Phase 1

» Test of the diagnosis-compatible system components with the vehicle at a standstill.



ABS indicator and warning light flashes.

Phase 2

» Test of the wheel-speed sensors as the vehicle pulls away from rest.



ABS indicator and warning light flashes.

ABS self-diagnosis completed

» The ABS indicator and warning light goes out.



ABS self-diagnosis not completed

The ABS function is not available, because self-diagnosis did not complete. (The motorcycle has to reach a defined minimum speed for the wheel speed sensors to be checked: 5 km/h)

If an indicator showing an ABS fault appears when ABS self-diagnosis completes:

- You can continue to ride. Bear in mind that the ABS function is not available.
- Have the fault rectified as quickly as possible by a specialist workshop, preferably an authorised BMW Motorrad retailer.

ASC self-diagnosis

BMW Motorrad ASC performs self-diagnosis to ensure its operability. Self-diagnosis is performed automatically when you switch on the ignition.

Phase 1

» Test of the diagnosable system components with the vehicle at a standstill.



ASC indicator and warning light slow-flashes.

Phase 2

» Test of the diagnosis-compatible system components while the motorcycle is on the move.



ASC indicator and warning light slow-flashes.

ASC self-diagnosis completed

» The ASC indicator and warning light goes out.

- Observe all the indicator and warning lights.



ASC self-diagnosis not completed

The ASC function is not available, because self-diagnosis did not complete. (The motorcycle has to reach a defined minimum speed for the wheel sensors to be checked: min 5 km/h)

If an indicator showing an ASC fault appears when ASC self-diagnosis completes:

- You can continue to ride. Bear in mind that the ASC function is not available.
- Have the fault rectified as quickly as possible by a specialist workshop, preferably an authorised BMW Motorrad retailer.

DTC self-diagnosis

BMW Motorrad DTC performs self-diagnosis to ensure its operability. Self-diagnosis is performed automatically when you switch on the ignition.

Phase 1

» Test of the diagnosis-compatible system components with the vehicle at a standstill.



slow-flashes.

Phase 2

» Pullaway test of the diagnosis-compatible system components.



slow-flashes.

DTC self-diagnosis completed

» The DTC symbol no longer shows.

- Observe all the indicator and warning lights.



DTC self-diagnosis not completed

The DTC function is not available, because self-diagnosis did not complete. (The motorcycle has to reach a defined minimum speed with the engine running for the wheel-speed sensors to be checked: min 5 km/h)

134 RIDING

If an indicator showing a DTC fault appears when DTC self-diagnosis completes:

- You can continue to ride.
Bear in mind that the DTC function is not available or the functionality might be subject to certain restrictions.
- Have the fault rectified as quickly as possible by a specialist workshop, preferably an authorised BMW Motorrad retailer.

RUNNING IN

Engine

- Until the running-in check, vary the throttle opening and engine-speed range frequently; avoid riding at constant engine rpm for prolonged periods.
- Try to do most of your riding during this initial period on twisting, fairly hilly roads, avoiding high-speed main roads and highways if possible.
- Comply with the running-in speeds.



Running-in speed

<6500 min⁻¹ (Odometer reading 0...1200 km)



Running-in speed

No full load (Odometer reading 0...1200 km)

- Note the mileage after which the running-in check should be carried out.



Mileage until the first running-in check

500...1200 km

Brake pads

New brake pads have to bed down before they can achieve their optimum friction levels. You can compensate for this initial reduction in braking efficiency by exerting greater pressure on the levers.



WARNING

New brake pads

Longer stopping distance, risk of accident

- Apply the brakes in good time.

Tyres

New tyres have a smooth surface. This must be roughened by riding in a restrained manner at various heel angles until the tyres are run in. This running in procedure is essential

if the tyres are to achieve maximum grip.



WARNING

New tyres losing grip on wet roads and at extreme bank angles

Risk of accident

- Ride carefully and avoid extremely sharp inclines.

SHIFTING GEAR

–with shift assistant Pro^{OE}

Gear Shift Assistant Pro



For safety reasons, cruise control is automatically deactivated when Gear Shift Assistant Pro downshifts.



- Select the gears in the usual way by using the foot-operated gearshift lever.
- » The shift assistant assists upshifts and downshifts without the rider having to pull the clutch or close the throttle.
- This is not an automatic-shift system.
- The rider is the most important part of the system and decides when to shift gears.
- The sensor **1** on the gearshift shaft registers the gearshift request and triggers shift assistance.
- » When riding at a steady speed in a low gear at high engine rpm, an attempt to shift gear without pulling the clutch can cause a severe load-change reaction.
- BMW Motorrad recommends disengaging the clutch for shifts in these circumstances.
- It is advisable to avoid using Gear Shift Assistant Pro at engine speeds close to the limits at which the governor cuts in to limit engine rpm.
- » Shift assistance is not available in the following situations:
 - With clutch lever pulled.
 - Gearshift lever not in its initial position
 - Upshifts with the throttle valve closed (engine overrun) and when slowing.
 - Downshifts with throttle valve open and when accelerating.
- Once the gearshift has completed, the gearshift lever has to be fully released before an-

136 RIDING

other gearshift with the Gear Shift Assistant Pro can take place. More detailed information on the Gear Shift Assistant Pro (► 159).

SHIFT LIGHT

–with riding modes Pro^{OE}

Function

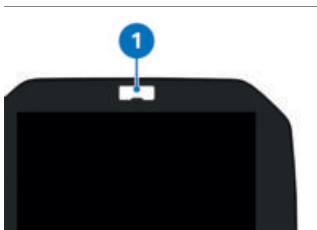

Shift light **1** indicates that the engine speed at which the rider should upshift is approaching.

- Shift light flashes at preset frequency: Approaching upshift rpm
- Shift light goes out: Engine revving at upshift rpm

The engine-speed thresholds and the way in which the shift light indicates the various states can be customised by navigating to *Settings*, *Vehicle settings*, also see the section on operation (► 86).

BRAKES

How can stopping distance be minimised?

Each time the brakes are applied, a load distribution shift takes place with the load shifting forward from the rear to the front wheel. The sharper the motorcycle decelerates, the more load is shifted to the front wheel. The higher the wheel load, the more braking force can be transmitted without the wheel locking. To optimise stopping distance, apply the front brakes rapidly and keep on increasing the force you apply to the brake lever. This makes the best possible use of the dynamic increase in load at the front wheel. Remember to pull the clutch at the same time. In the "emergency braking situations" that are trained so frequently, braking force is applied as rapidly as possible and with the rider's full force applied to the brake levers; under these circumstances the dynamic shift in load distribution cannot keep pace with the increase in deceleration and the tyres cannot transmit the full braking force to the surface of the road. Un-

der these circumstances the front wheel can lock up. BMW Motorrad ABS prevents the front wheel from locking up.

Emergency braking

If you brake sharply from a speed in excess of 50 km/h, the brake light flashes rapidly as a warning for road users behind you.

If you brake until your speed is less than 15 km/h, the hazard warning lights start to flash as well. The hazard warning lights switch off automatically as soon as you start to accelerate and vehicle speed reaches 20 km/h.

Descending mountain passes



WARNING

Braking mostly with the rear brake on mountain descents

Brake fade, destruction of the brakes due to overheating

- Use both front and rear brakes, and make use of the engine's braking effect as well.

Wet and dirty brakes

Wetness and dirt on the brake discs and the brake pads diminish braking efficiency. Delayed braking action or poor braking efficiency must be reckoned with in the following situations:

- Riding in the rain or through puddles of water.
- After the vehicle has been washed.
- Riding on salted or gritted roads.
- After work has been carried on the brakes, due to traces of oil or grease.
- Riding on dirt-covered surfaces or off-road.



WARNING

Wetness and dirt result in diminished braking efficiency

Risk of accident

- Apply the brakes lightly while riding to remove wetness and dirt, or dismount and clean the brakes.
- Think ahead and brake in good time until full braking efficiency is restored.

138 RIDING

ABS Pro

–with riding modes Pro^{OE}

Physical limits applicable to motorcycling

WARNING

Braking when cornering

Risk of crash despite ABS Pro

- Invariably, it remains the rider's responsibility to adapt riding style to riding conditions.
- Do not take risks that would negate the additional safety offered by this system.

ABS Pro is available in all riding modes except Dynamic PRO.

Possibility of a fall not precluded

Although ABS Pro provides the rider with valuable assistance and constitutes a huge advance in safety for braking with the motorcycle banked for cornering, it cannot under any circumstances be considered as re-defining the physical limits that apply to motorcycling. It is still possible for these limits to be overshoot due to misjudgement or rider error. In extreme cases this can result in a crash.

Use on public roads

ABS Pro helps make the motorcycle even safer for riding on public roads. When the brakes are applied because of an unforeseen hazard when the motorcycle is banked for cornering, within the physical limits that apply to motorcycling the system prevents the wheels from locking and skidding away.

 ABS Pro was not developed to enhance individual braking performance with the motorcycle banked into corners.

PARKING YOUR MOTORCYCLE

Side stand

- Switch off the engine.

ATTENTION

Poor ground underneath the stand

Risk of damage to parts if vehicle topples

- Always check that the ground under the stand is level and firm.

**ATTENTION****Additional weight placing strain on the side stand**

Risk of damage to parts if vehicle topples

- Do not sit or lean on the vehicle while it is propped on the side stand.

- Extend the side stand and prop the motorcycle on the stand.
- If the camber of the roadway permits, turn the handlebars all the way to the left.
- The motorcycle should always face uphill on a gradient; select 1st gear.

Centre stand

—with centre stand^{OE}

- Switch off the engine.

**ATTENTION****Poor ground underneath the stand**

Risk of damage to parts if vehicle topples

- Always check that the ground under the stand is level and firm.

**ATTENTION****Centre stand retracts due to severe movements**

Risk of damage to parts if vehicle topples

- Do not lean or sit on the vehicle with the centre stand extended.

- Extend the centre stand and lift the motorcycle on to the stand.

REFUELLING**Fuel grade****Requirement**

For optimum fuel consumption, fuel should be sulphur-free or as low-sulphur as possible.

**ATTENTION****Engine operation with leaded fuel**

Damage to catalytic converter

- Do not attempt to run the vehicle on leaded fuel or fuel with metallic additives (e.g. manganese or iron).

- Observe the maximum ethanol content of the fuel.





Fuel additives clean the fuel injection system and the combustion zone. It is advisable to use fuel additives

140 RIDING

when the engine is operated with low-grade fuel or if the vehicle is to be out of use for a lengthy period of time. More information is available from your authorised BMW Motorrad retailer.

Recommended fuel grade, F 900 R A2 (0K31)

A different fuel grade can be used for the A2 version. See the more detailed information in the "Technical data" section.

	Recommended fuel grade
	Premium unleaded (maximum 15% ethanol, E15)
	95 ROZ/RON 90 AKI
-with regular-grade fuel, unleaded ^{OE}	
Regular, unleaded (control is national-market-specific) (maximum 15% ethanol, E15) 91 ROZ/RON 87 AKI◀	

» Pay attention to the following symbols in the fuel filler cap and on the fuel pump:



Refuelling

WARNING

Fuel is highly flammable

Risk of fire and explosion

- Do not smoke. Never bring a naked flame near the fuel tank.

WARNING

Escape of fuel due to heat-induced expansion if fuel tank is overfilled

Risk of falling

- Do not overfill the fuel tank.

ATTENTION

Wetting of plastic surfaces by fuel

Damage to the surfaces (surfaces become unsightly or dull)

- Clean plastic surfaces immediately after contact with fuel.

- Make sure the ground is level and firm and place the motorcycle on its side stand.

–with centre stand^{OE}

- Make sure the ground is level and firm and place the motorcycle on its centre stand.◁





- Open protective flap **1**.
- Unlock fuel tank cap **2** by turning the ignition key clockwise and pop the cap open.



- Do not fill the tank past the bottom edge of the filler neck.

 When refuelling after running on reserve, make sure that you top up the tank to a level above reserve, so that the new level is detected and the fuel reserve indicator light is switched off.

 The "usable fuel capacity" specified in the technical data is the quantity that the fuel tank could hold if refilled after it had been run dry and the engine had cut out due to a lack of fuel.

 Fuel tank capacity

approx. 13 l

 Reserve fuel

approx. 3.5 l

- Press the fuel tank cap down firmly to close.
- Remove the ignition key and close the protective cap.

Refuelling

–with Keyless Ride^{OE}

Requirement

The steering lock is disengaged.

WARNING

Fuel is highly flammable

Risk of fire and explosion

- Do not smoke. Never bring a naked flame near the fuel tank.

- » The indicator light for the radio-operated key flashes while the search for the radio-operated key is in progress.
- Slowly pull tab **1** on the fuel filler cap up again.
- » Fuel filler cap unlocks.
- Fully open the fuel filler cap.



- Refuel with fuel of the grade stated above; do not fill the tank past the bottom edge of the filler neck.

 When refuelling after running on reserve, make sure that you top up the tank to a level above reserve, so that the new level is detected and the fuel reserve indicator light is switched off.

 The "usable fuel capacity" specified in the technical data is the quantity that the fuel tank could hold if refilled after it had been run dry and the engine had cut out due to a lack of fuel.

 Fuel tank capacity

approx. 13 l

 Reserve fuel

approx. 3.5 l

- Press down firmly on the filler cap of the fuel tank.
- » The fuel filler cap engages with an audible click.
- » The fuel filler cap locks automatically when the waiting time expires.
- » The engaged fuel filler cap locks immediately when you secure the steering lock or switch on the ignition.

Opening fuel filler cap emergency release

—with Keyless Ride^{OE}

Fuel filler cap cannot be opened.

- Have the fault rectified as quickly as possible by a specialist workshop, preferably an authorised BMW Motorrad retailer.

144 RIDING



- Remove screws **1**.
- Remove emergency release **2**.
» Fuel filler cap unlocks.
- Fully open the fuel filler cap.
- Refuel (▣▣▣ 141).
- Close the fuel filler cap emergency release (▣▣▣ 144).

Closing fuel filler cap emergency release

—with Keyless Ride^{OE}

Requirement

Fuel filler cap is in closed position.

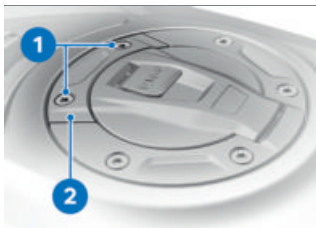

- Hold emergency release **2** in position.
- Install screws **1**.

SECURING MOTORCYCLE FOR TRANSPORTATION

- Make sure that all components that might come into contact with straps used to secure the motorcycle are adequately protected against scratching. Use adhesive tape or soft cloths, for example, for this purpose.



ATTENTION

Vehicle topples to side when being lifted on to stand

Risk of damage to parts if vehicle topples

- Secure the vehicle to prevent it toppling, preferably with the assistance of a second person.
- Push the motorcycle on to the transportation flat and hold it in position: do not place it on the side stand or centre stand.



ATTENTION

Trapping of components

Component damage

- Do not trap components such as brake lines or cable legs.
- At the front, secure the straps to the bottom fork bridge on both sides and tighten the straps.



- At the rear, secure the straps to the footrest plates on both sides and tighten the straps.
- Uniformly tighten all the straps.

ENGINEERING DETAILS

08

GENERAL NOTES	148
ANTILOCK BRAKE SYSTEM (ABS)	148
TRACTION CONTROL (ASC/DTC)	151
DYNAMIC ENGINE BRAKE CONTROL	153
DYNAMIC ESA	154
RIDING MODE	154
DYNAMIC BRAKE CONTROL	156
TYRE PRESSURE CONTROL (RDC)	157
GEAR SHIFT ASSISTANT	159
ADAPTIVE HEADLIGHT	160

GENERAL NOTES

To find out more about engineering, go to:

bmw-motorrad.com/technik

ANTILOCK BRAKE SYSTEM (ABS)

How does ABS work?

The amount of braking force that can be transferred to the road depends on factors that include the coefficient of friction of the road surface. Loose stones, ice and snow or a wet road all have much lower coefficients of friction than a clean, dry asphalt surface. The lower the coefficient of friction, the longer the stopping distance. If the rider increases braking pressure to the extent that braking force exceeds the maximum transferable limit, the wheels start to lock and the motorcycle loses its directional stability; a fall is imminent. Before this situation can occur, ABS intervenes and adapts braking pressure to the maximum transferable braking force, so the wheels continue to turn and directional stability is maintained irrespective of the condition of the road surface.

What are the effects of surface irregularities?

Humps and surface irregularities can cause the wheels to lose contact temporarily with the road surface; if this happens the braking force that can be transmitted to the road can drop to zero. If the brakes are applied under these circumstances the ABS has to reduce braking force to ensure that directional stability is maintained when the wheels regain contact with the road surface. At this instant the BMW Motorrad ABS must assume an extremely low coefficient of friction (gravel, ice, snow), so that the wheels will continue to rotate under all imaginable circumstances, because this is the precondition for ensuring directional stability. As soon as it registers the actual circumstances, the system reacts instantly and adjusts braking force accordingly to achieve optimum braking.

Rear wheel lift

Under very severe and sudden deceleration, however, under certain circumstances it is possible that the BMW Motorrad ABS will be unable to prevent the rear wheel from lifting clear of the ground. If this happens the outcome can be a highside situation in which the motorcycle can flip over.



WARNING

Rear wheel lift due to severe braking

Risk of falling

- When you brake sharply, bear in mind that ABS control cannot always be relied on to prevent the rear wheel from lifting clear of the ground.

What is the design baseline for BMW Motorrad ABS?

Within the limits imposed by physics, the BMW Motorrad ABS ensures directional stability on any surface.

At speeds above 4 km/h, within the limits imposed by physics the BMW Motorrad ABS can ensure directional stability

on any surface. Limitations inherent to the design principle mean that at lower speeds the BMW Motorrad ABS cannot provide optimum assistance on all surfaces.

The system is not optimised for special requirements that apply under extreme competitive situations off-road or on the track.

Special situations

The speeds of the front and rear wheels are compared as one means of detecting a wheel's incipient tendency to lock. If the system registers implausible values for a lengthy period the ABS function is deactivated for safety reasons and an ABS fault message is issued. Self-diagnosis has to complete before fault messages can be issued. In addition to problems with the BMW Motorrad ABS, exceptional riding conditions can lead to a fault message being issued:

- Riding for a lengthy period with the front wheel lifted off the ground (wheelie).
- Rear wheel rotating with the vehicle held stationary by ap-

150 ENGINEERING DETAILS

plication of the front brake (burn-out).

- Heating up with the motorcycle on the centre stand or an auxiliary stand, engine idling or with a gear engaged.
- Rear wheel locked by the engine brake for a lengthy period, for example while descending on a loose or slippery surface.

If a fault message is issued on account of exceptional riding conditions, you can reactivate the ABS function by switching the ignition off and on again.

What significance devolves on regular servicing?



WARNING

Brake system not regularly serviced

Risk of accident

- In order to ensure that the BMW Motorrad ABS is always maintained in optimum condition, it is essential for you to comply strictly with the specified inspection intervals.

Safety reserves

The potentially shorter braking distances which BMW Motorrad ABS permits must not be used as an excuse for careless riding. The system is primarily a means of ensuring a safety margin in genuine emergencies.

Take care when cornering!

When you apply the brakes on a corner, the vehicle's weight and momentum take over and even BMW Motorrad ABS is unable to counteract their effects.

Evolution of ABS to ABS Pro

-with riding modes Pro^{OE}

Until now, the BMW Motorrad ABS helped ensure a very high degree of safety for braking with the motorcycle upright and travelling in a straight line. Now ABS Pro offers enhanced safety for braking in corners as well. ABS Pro prevents the wheels from locking even under sharp braking. ABS Pro reduces abrupt changes in steering force, particularly in panic-braking situations, counteracting the vehicle's otherwise natural but undesirable tendency to straighten up.

ABS intervention

Technically speaking, depending on the riding situation ABS Pro adapts ABS intervention to the motorcycle's bank angle. Signals for rate of roll and rate of yaw and lateral acceleration are used to calculate bank angle. As the motorcycle is heeled over more and more as it banks into a corner, an increasingly strict limit is imposed on the brake-pressure gradient for the start of brake application. This slows the build-up of brake pressure to a corresponding degree. Additionally, pressure modulation is more uniform across the range of ABS intervention.

Advantages for the rider

The advantages of ABS Pro for the rider are sensitive response and high braking and directional stability combined with best-case deceleration of the motorcycle, even when cornering.

TRACTION CONTROL (ASC/DTC)

How does traction control work?

Traction control is available in two versions

- without** provision for the bank angle: Automatic Stability Control ASC
- ASC is a rudimentary function intended to prevent falls.
- with** provision for bank angle: Dynamic Traction Control DTC
- DTC regulation is more delicate and more comfortable thanks to the additional bank angle and acceleration information.

Traction control compares the front and rear wheel circumferential velocities. The differential is used to compute slip as a measure of the reserves of stability available at the rear wheel. If slip exceeds a certain limit, the engine management system intervenes and adapts engine torque accordingly. BMW Motorrad ASC/DTC is designed as an assistant system for the rider and for use on public roads. The extent to which the rider affects ASC/DTC control can be considerable (weight shifts when cor-

152 ENGINEERING DETAILS

nering, items of luggage loose on the motorcycle), especially when the style of riding takes rider and machine close to the limits imposed by physics. The system is not optimised for special requirements that apply under extreme competitive situations off-road or on the track. The BMW Motorrad ASC/DTC can be deactivated in these cases.



WARNING

Risky riding

Risk of accident despite ASC/DTC

- Invariably, it remains the rider's responsibility to adapt riding style to riding conditions.
- Do not take risks that would negate the additional safety offered by this system.

Special situations

In accordance with the laws of physics, the ability to accelerate is restricted more and more as the angle of heel increases. Consequently, there can be a perceptible reduction in acceleration out of very tight bends.

The speeds of the front and rear wheels are compared and DTC, unlike ASC, also takes the bank angle into account in processing data to detect the rear wheel's incipient tendency to spin or slip sideways.

–with riding modes Pro^{OE}
If the electronic processor receives values for the bank angle that it considers implausible over a lengthy period, a dummy value is used for the bank angle or the DTC function is switched off. Under these circumstances the indicator for a DTC fault shows. Self-diagnosis has to complete before fault messages can be issued.

The BMW Motorrad Traction Control can shut down automatically under the exceptional riding conditions outlined below.

Exceptional riding conditions:

- Riding for a lengthy period with the front wheel lifted off the ground (wheelie).
- Rear wheel rotating with the vehicle held stationary by application of the front brake (burn-out).
- Heating up with the motorcycle on an auxiliary stand,

in neutral or with a gear engaged.



Minimum speed for activation of DTC

min 5 km/h

–with riding modes Pro^{OE}

If the front wheel lifts clear of the ground under severe acceleration, the DTC reduces engine torque in the RAIN and ROAD riding modes until the front wheel regains contact with the ground.

Front wheel lift-off detection allows brief wheelies when the DTC setting is DYNAMIC.

In DYNAMIC PRO riding mode, front wheel lift-off detection is switched off.

BMW Motorrad recommends turning the throttle grip back slightly when lifting the front wheel in order to reach a stable driving condition again as soon as possible.

In RAIN, ROAD and DYNAMIC riding modes, the DTC setting corresponds to the riding mode.

In DYNAMIC PRO riding mode, DTC can be set differently.

DYNAMIC ENGINE BRAKE CONTROL

–with riding modes Pro^{OE}

How does dynamic engine brake control work?

The purpose of dynamic engine brake control is to prevent the unstable riding states that can be produced by excessive engine braking moment acting on the rear wheel. Depending on the road condition and riding dynamic, excessive braking torque can produce a sharp rise in rear-wheel slip and impair directional stability. Dynamic engine brake control limits this slip at the rear wheel to a safe, mode-dependent regulated slip.

Causes for excessive slip at the rear wheel:

- Riding with engine overrun on a surface with a low coefficient of friction (e.g. wet leaves).
- Rear-wheel hop when rider downshifts.
- Sharp braking during sporty riding.

In the same way as BMW Motorrad DTC dynamic traction control, dynamic engine brake control compares the wheel circumferential

154 ENGINEERING DETAILS

velocities of the front and rear wheels calculated from the wheel speeds and the tyre radius. Dynamic engine brake control uses this differential to compute slip as a measure of the reserve of stability available at the rear wheel.

If slip overshoots the applicable limit, the throttle valves are opened very slightly to increase engine torque. Slip is reduced and the vehicle is stabilised.

Effect of dynamic engine brake control

- In the RAIN and ROAD riding modes: Maximum stability.
- with riding modes Pro^{OE}
- In DYNAMIC and DYNAMIC PRO riding modes: compared with the RAIN and ROAD riding modes, reduced intervention.

DYNAMIC ESA

- with Dynamic ESA^{OE}

Dynamic ESA function

Dynamic ESA uses a ride height sensor to detect movements in the suspension and responds by adjusting the damper valve. This enables the suspension to adapt to the terrain.

Dynamic ESA calibrates itself at regular intervals to ensure the system functions correctly.

Possibilities for adjustment

Damping modes

- Road: Damping for comfortable on-road riding
- Dynamic: Damping for dynamic on-road riding

Load settings

- One-up riding
- One-up with luggage
- Two-up (with luggage)

RIDING MODE

Selection

To adjust the motorcycle to the road condition and the desired driving experience, the following riding modes can be selected:

Standard

- RAIN
- ROAD (default mode)

-with riding modes Pro^{OE}
with Pro riding modes

- DYNAMIC
- DYNAMIC PRO

For each of these riding modes, there is a matching setting for the ABS, ASC/DTC systems, for dynamic engine brake control and for throttle response.

–with Dynamic ESA^{OE}
Dynamic ESA can be parametrised independently of the selected riding mode.

ASC/DTC can be switched off in each riding mode. The explanations below always refer to the dynamic safety systems that are switched on.

Throttle response

- In RAIN riding mode: the engine's throttle response is soft.
- In ROAD riding mode: the engine's throttle response is optimum.
- In DYNAMIC riding mode: the engine's throttle response is direct.
- In DYNAMIC PRO riding mode: the engine's throttle response can be parametrised to suit the rider's individual needs and preferences.

ABS

- Rear wheel lift-off detection is active in all riding modes except in the factory default settings of the DYNAMIC PRO mode.
- Rear wheel lift-off detection is reduced in the DYNAMIC riding mode to achieve an enhanced braking effect.

–In DYNAMIC PRO riding mode, ABS can be set up differently.

–with riding modes Pro^{OE}

ABS Pro

- In the RAIN and ROAD riding modes, ABS Pro is fully available. The tendency of the motorcycle to straighten up when the brakes are applied with the machine banked for cornering is reduced to a minimum.
- In the DYNAMIC riding mode, ABS Pro is available only when the coefficient of friction is good. Assistance is less than in the RAIN and ROAD riding modes riding mode and instead, the system is set up to achieve maximised braking effect.
- In the DYNAMIC PRO riding mode, the factory default setting for ABS Pro is OFF.

ASC

- ASC is set up for on-road riding.
- In the ASC setting RAIN, ASC intervenes early to maximise riding stability.
- In the ASC setting ROAD, ASC intervenes later than in the RAIN riding mode. This

156 ENGINEERING DETAILS

prevents the rear wheel from spinning whenever possible.

–with riding modes Pro^{OE}

DTC

Tyres

–DTC is set up for on-road riding with road tyres in all riding modes.

Driving stability

–In the DTC setting RAIN, DTC intervenes early enough to achieve maximum driving stability.

–In the DTC setting ROAD, DTC intervenes later than in the RAIN riding mode. This prevents the rear wheel from spinning whenever possible.

–In the DTC settings for RAIN and ROAD, the front wheel is prevented from lifting.

–In the DTC setting DYNAMIC, DTC intervenes later than in the ROAD riding mode, so slight drift can be induced when exiting corners and brief wheelies are also possible.

In the DTC settings RAIN, ROAD and DYNAMIC the DTC setting corresponds to the riding mode.

In the DTC setting DYNAMIC PRO, DTC can be set differently.

Mode changes

The riding mode can be changed while the vehicle is stationary with the ignition on. Under the following precondition, it is also possible

to change modes while riding:

–No drive torque on the rear wheel.

–No brake pressure in the brake system.

The following steps must be taken to change the riding mode:

–Close the throttle twistgrip.

–Release the brake levers.

–Deactivate cruise control.

The desired riding mode is initially preselected. The mode change does not take place until the systems in question are all in the appropriate state.

The selection menu does not disappear from the display until the mode change has taken place.

DYNAMIC BRAKE CONTROL

–with riding modes Pro^{OE}

How Dynamic Brake Control works

The Dynamic Brake Control function assists the rider in emergency braking situations.

Detection of emergency braking

–Sudden, sharp application of the front brake is interpreted as emergency braking.

Behaviour in emergency braking

–If emergency braking occurs at a speed in excess of 10 km/h, the ABS function is further assisted by Dynamic Brake Control.

Behaviour during accidental actuation of the throttle grip

- If the throttle is accidentally opened (throttle grip position > 5 %) during emergency braking, Dynamic Brake Control ensures the desired braking effect by ignoring actuation of the throttle grip. The effectiveness of emergency braking is ensured.
- If the throttle is closed (throttle grip position < 5 %) while Dynamic Brake Control is in action, the engine torque requested by the ABS brake system is restored.
- If emergency braking ceases and the rider still has not

changed the position of the throttle grip, Dynamic Brake Control steadily ramps engine torque back to the rider's requested level.

TYRE PRESSURE CONTROL (RDC)

–with tyre pressure control (RDC)^{OE}

Function

A sensor integrated into each tyre measures the air temperature and the air pressure inside the tyre and transmits this information to the control unit. Each sensor has a centrifugal-force tripswitch that does not enable transmission of the measured values until the motorcycle has accelerated to a defined minimum speed for the first time.

	Minimum speed for transmission of the RDC measured values:
--	--

min 30 km/h

The display shows -- for each tyre until the tyre-pressure signal is received for the first time. The sensors continue to transmit the measured-value signals for some time after the vehicle comes to a stop.

 <p>Time for transmission of measured values after vehicle comes to a stop:</p>
min 15 min

An error message is issued if wheels without sensors are fitted to a vehicle equipped with an RDC control unit.

Tyre pressure ranges

The RDC control unit distinguishes between three tyre pressure ranges matched to the vehicle:

- Tyre pressure within permitted tolerance.
- Tyre pressure close to limit of permitted tolerance.
- Tyre pressure outside permitted tolerance.

Temperature compensation

Tyre pressure is a temperature-sensitive variable: pressure increases as tyre-air temperature rises and decreases as tyre-air temperature drops. Tyre-air temperature depends on ambient temperature as well as on the style of riding and the duration of the ride.

 <p>The tyre pressures are shown in the display as temperature compensated and always refer to the following tyre air temperature:</p>
20 °C

The air lines available to the public in petrol stations and motorway service areas have gauges that do not compensate for temperature; the reading shown by a gauge of this nature is the temperature-dependent tyre-air pressure. As a result, the values displayed there usually do not correspond to the values displayed in the display.

Pressure adaptation

Compare the RDC value on the display with the value in the table on the back cover of the rider's manual. Then use the air-line gauge at a service station to compensate for the difference between the RDC reading and the value in the table.

 <p>Example</p>
According to the operating instructions, the tyre pressure should be:
2.5 bar

 Example
The following value is shown in the display:
2.3 bar
So pressure is low by:
0.2 bar
The gauge on the air line shows:
2.4 bar
You must now increase tyre pressure until the value is:
2.6 bar

GEAR SHIFT ASSISTANT

–with shift assistant Pro^{OE}

Gear Shift Assistant Pro

Your vehicle is equipped with Gear Shift Assistant Pro, a system originally developed for racing and now adapted for the touring sector. It permits upshifts and downshifts without declutching or closing the throttle in virtually all load and rpm ranges.

Advantages

- 70-80 % of all gearshifts on a trip can be done without using the clutch.
- Less relative movement between rider and passenger

because the shift pauses are shorter.

- It is not necessary to close the throttle valve when shifting under acceleration.
- When braking and downshifting (throttle valve closed), engine speed is adjusted by blipping the throttle.
- Shift time is shorter than a gearshift with clutch actuation.

In order for the system to identify a request for a gearshift, the rider has to move the shift lever from its idle position in the desired direction against the force of the spring through a certain "overtravel" at ordinary speed or rapidly and keep the shift lever in this position until the gearshift is completed. It is not necessary to increase the force applied to the gearshift lever while shifting is in progress. Once the gearshift has completed the shift lever has to be fully released before another gearshift with the Pro shift assistant can take place. When shifting gears with the Gear Shift Assistant Pro, the rider has to keep load state (throttle twistgrip position) constant before and during the gearshift.

160 ENGINEERING DETAILS

A change in the position of the throttle twistgrip during a gearshift can cause the function to abort and/or lead to a missed shift. Gear Shift Assistant Pro provides no assistance for the gearshift if the rider declutches.

Downshifting

–Downshifting is assisted until maximum rpm for the target gear to be selected is reached. This prevents over-revving.



Maximum engine speed

max 9000 min⁻¹

Upshifting

–Upshifting is assisted until idle rpm for the target gear to be selected is reached.
–This prevents the engine from dropping below idle speed.



Idle speed

1250^{±50} min⁻¹ (Engine at regular operating temperature)

ADAPTIVE HEADLIGHT

–with adaptive head light^{OE}

Function

In addition to the bulbs for low beam, high beam and daytime riding light, or side light, the headlight has two separate LED elements complete with their own reflectors. The LED elements are activated as a function of bank angle in addition to the low-beam headlight, enabling the headlight to illuminate the inside of the bend as the motorcycle banks for cornering. The adaptive cornering headlight is optimised for slight to moderate bank angles. The adaptive cornering headlight is activated under the following conditions:

- Cornering at a slight to moderate bank angle.
- Speed is higher than 10 km/h.
- The low-beam headlight is switched on.

MAINTENANCE

09

GENERAL NOTES	164
TOOLKIT	165
SERVICE TOOL KIT	165
FRONT-WHEEL STAND	165
REAR-WHEEL STAND	166
ENGINE OIL	167
BRAKE SYSTEM	169
CLUTCH	173
COOLANT	174
TYRES	175
WHEEL RIMS	176
WHEELS	176
CHAIN	186
LIGHTING	189
JUMP-STARTING	190
BATTERY	191
FUSES	195
DIAGNOSTIC CONNECTOR	197

GENERAL NOTES

The Maintenance chapter describes straightforward procedures for checking and replacing certain wear parts.

Microencapsulated screws

The microencapsulation is a chemical thread-locker. An adhesive compound creates a secure connection between bolt and nut or between screw and component. Consequently, microencapsulated screws are for once-only use and are not intended for re-installation after being slackened.

After removal of the screw, clean the internal thread to remove all traces of thread-locking compound. Always use new microencapsulated screws when re-assembling. Consequently, prior to disassembly make sure that you have suitable tools for cleaning the threads and a new replacement for each screw to be removed. If the job is not done correctly there is no guarantee that the screw will remain secure, which means that you would be putting yourself at risk!

Further information

Special tightening torques are listed as applicable. The tightening torques for the threaded fasteners on your vehicle are listed in the section entitled "Technical data".

You will find information on more extensive maintenance and repair work in the repair manual on DVD for your vehicle, available from your authorised BMW Motorrad retailer.

Some of the work calls for special tools and a thorough knowledge of the technology involved. If you are in doubt, consult a specialist workshop, preferably your authorised BMW Motorrad retailer.

TOOLKIT

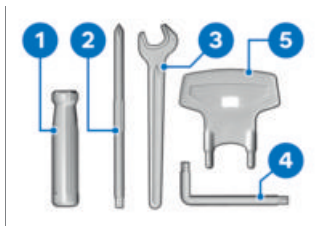

- 1** Screwdriver handle
- 2** Reversible screwdriver blade
With star-head and plain-tip ends
-Remove the battery (▶▶▶ 193).
-Adjust the damping for rear wheel (▶▶▶ 121).
- 3** Open-ended spanner
Width across flats 14 mm
-Adjust the mirror arm (▶▶▶ 118).
- 4** Torx wrench, T25/T30
T25 on short end, T30 on long end
- 5** Keys
-Adjust the spring preload for rear wheel (▶▶▶ 120).

SERVICE TOOL KIT

-with service toolkit^{OA}



BMW Motorrad has assembled a service toolkit that is ideal for carrying out extended service work (e.g. removing and installing wheels) on this motorcycle. This toolkit is available from your authorised BMW Motorrad retailer.

FRONT-WHEEL STAND

Installing front-wheel stand



ATTENTION

Use of the BMW Motorrad front-wheel stand without also using the auxiliary stand

Risk of damage to parts if vehicle topples

- Place the motorcycle on an auxiliary stand before lifting the front wheel with the BMW Motorrad front-wheel stand.

166 MAINTENANCE

- Make sure the motorcycle is standing firmly.
- Place the motorcycle on an auxiliary stand; BMW Motorrad recommends the BMW Motorrad auxiliary stand.
- Install the rear-wheel stand (▶▶▶ 166).



- See the instructions issued with the front-wheel stand for the details of the correct procedure for installation.
- BMW Motorrad offers an auxiliary stand suitable for every vehicle. Your BMW Motorrad retailer will be happy to help you with the selection of a suitable auxiliary stand.

REAR-WHEEL STAND

Installing rear-wheel stand



- The description of how to fit the rear-wheel stand correctly will be found in the instructions for the stand.
- BMW Motorrad offers an auxiliary stand suitable for every vehicle. Your BMW Motorrad retailer will be happy to help you with the selection of a suitable auxiliary stand.

ENGINE OIL

Checking engine oil level

ATTENTION

Misinterpretation of oil level reading, because oil level is temperature-dependent (the higher the temperature, the higher the oil level)

Engine damage

- Check the oil level only after a lengthy ride or when the engine is at operating temperature.
- Wipe the area around the oil filler opening clean.
- Allow the engine to idle until the fan starts up, then allow it to idle one minute longer.
- Switch off the engine.

ATTENTION

Vehicle toppling sideways

Risk of damage to parts if vehicle topples

- Secure the vehicle, preferably with the assistance of a second person, so that it cannot topple sideways.
- Make sure the engine is at operating temperature and hold the motorcycle upright. BMW Motorrad recommends

using a suitable auxiliary stand.

–with centre stand^{OE}

- Make sure the ground is level and firm and with the engine at operating temperature, place the motorcycle on its centre stand.◀

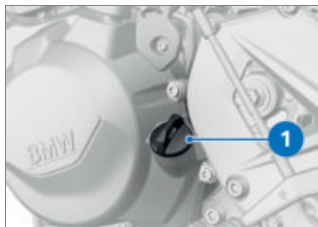

- Wait five minutes for the oil to drain into the oil pan.
- Remove oil dipstick **1**.

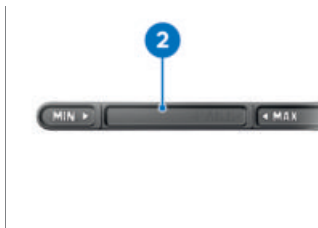

- Clean measuring area **2** with a dry cloth

168 MAINTENANCE

- Seat the oil dipstick on the oil filler neck, but do not engage the threads.
- Remove the oil dipstick and check the oil level.

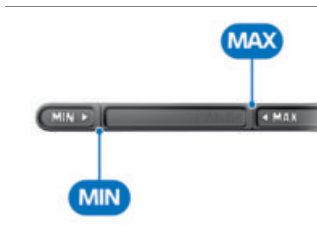

Engine oil, specified level

Between **MIN** and **MAX** marks



Engine oil, quantity for topping up

max 0.5 l (Difference between **MIN** and **MAX**)

If the oil level is below the **MIN** mark:

- Top up the engine oil (▮▮▮ 168).

If the oil level is above the **MAX** mark:

- Have the oil level corrected by a specialist workshop, preferably an authorised BMW Motorrad retailer.
- Install the oil dipstick.



To protect the environment, BMW Motorrad recommends occasionally checking the engine oil after a journey of at least 50 km.

Topping up engine oil

- Make sure the ground is level and firm and place the motorcycle on its stand.
- Wipe the area around the filler neck clean.

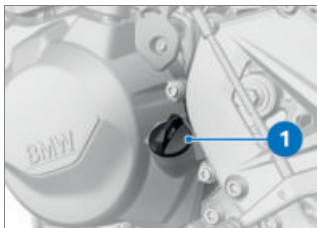

- Remove oil dipstick **1**.



ATTENTION

Use of insufficient engine oil or too much engine oil

Engine damage

- Always make sure that the oil level is correct.

- Top up the engine oil to the specified level.
- Check the engine oil level (▮▮▮ 167).
- Install the oil dipstick.

BRAKE SYSTEM

Checking operation of the brakes

- Operate the brake lever.
 - » The pressure point must be clearly perceptible.
- Press the footbrake lever.
 - » The pressure point must be clearly perceptible.

If pressure points are not clearly perceptible:



ATTENTION

Work on brake system not in compliance with correct procedure

Risk to operational reliability of the brake system

- Have all work on the brake system undertaken by trained and qualified specialists.
 - Have the brakes checked by a specialist workshop, preferably an authorised BMW Motorrad retailer.
- ### Checking brake pad thickness, front brakes
- Make sure the ground is level and firm and place the motorcycle on its stand.



- Visually inspect the left and right brake pads to ascertain their thickness. Viewing direction: Between wheel and front suspension toward brake calipers **1**.

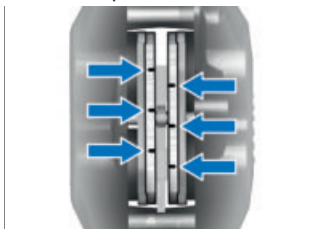

 Brake-pad wear limit, front

min 1.0 mm (Friction pad only, without backing plate. The wear indicators, i.e. the grooves, must be clearly visible.)

170 MAINTENANCE

If the wear indicating marks are no longer clearly visible:



WARNING

Brake-pad thickness less than permissible minimum

Diminished braking effect, damage to the brakes

- In order to ensure the dependability of the brake system, do not permit the brake pads to wear past the minimum permissible thickness.

- Have the brake pads replaced by a specialist workshop, preferably an authorised BMW Motorrad retailer.

Checking brake pad thickness, rear brakes

- Make sure the ground is level and firm and place the motorcycle on its stand.



- Visually inspect the brake pads to ascertain their thickness. Viewing direction: from

the rear toward brake caliper **1**.



Brake-pad wear limit, rear

min 1.0 mm (Friction pad only, without backing plate.)

If the brake pads are worn:



WARNING

Brake-pad thickness less than permissible minimum

Diminished braking effect, damage to the brakes

- In order to ensure the dependability of the brake system, do not permit the brake pads to wear past the minimum permissible thickness.

- Have the brake pads replaced by a specialist workshop, preferably an authorised BMW Motorrad retailer.

Checking brake-fluid level, front brakes



WARNING

Not enough brake fluid in brake fluid reservoir, or contaminants in brake fluid

Considerably reduced braking power due to presence of air, contaminants or water in the brake system

- Cease operation of the vehicle immediately and do not ride it until the fault has been rectified.
- Check the brake-fluid levels at regular intervals.
- Always make sure that the lid of the brake fluid reservoir and the area around the lid are cleaned before opening.
- Make sure that only fresh brake fluid from a sealed container is used.

–with centre stand^{OE}

- Make sure the ground is level and firm and place the motorcycle on its centre stand.
- Move the handlebars to the straight-ahead position.◁
- Make sure the ground is level and firm and hold the motorcycle upright.

- Move the handlebars to the straight-ahead position.



- Check the brake fluid level in brake fluid reservoir for front wheel brake **1**.



Wear of the brake pads causes the brake fluid level in the reservoir to sink.



Brake fluid level, front

Brake fluid, DOT4

It is not permissible for the brake fluid level to be below the **MIN** mark. (Brake-fluid reservoir horizontal, motorcycle upright)

172 MAINTENANCE

If the brake fluid level drops below the permitted level:

- Have the fault rectified as quickly as possible by a specialist workshop, preferably an authorised BMW Motorrad retailer.

Checking brake-fluid level, rear brakes

WARNING

Not enough brake fluid in brake fluid reservoir, or contaminants in brake fluid

Considerably reduced braking power due to presence of air, contaminants or water in the brake system

- Cease operation of the vehicle immediately and do not ride it until the fault has been rectified.
 - Check the brake-fluid levels at regular intervals.
 - Always make sure that the lid of the brake fluid reservoir and the area around the lid are cleaned before opening.
 - Make sure that only fresh brake fluid from a sealed container is used.
- Make sure the ground is level and firm and hold the motorcycle upright.

—with centre stand^{OE}

- Make sure the ground is level and firm and place the motorcycle on its centre stand. ◀

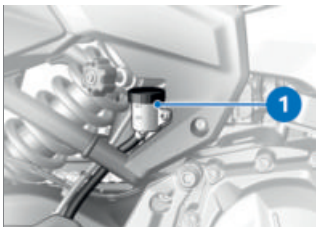

- Check the brake fluid level in brake fluid reservoir for rear wheel brake 1.

 Wear of the brake pads causes the brake fluid level in the reservoir to sink.

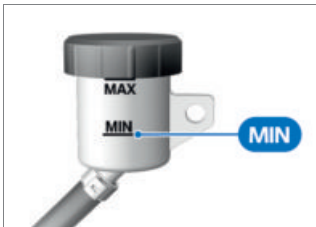

 Brake fluid level, rear (visual inspection)

Brake fluid, DOT4

It is not permissible for the brake fluid level to be below the **MIN** mark.

If the brake fluid level drops below the permitted level:

- Have the fault rectified as quickly as possible by a specialist workshop, preferably an authorised BMW Motorrad retailer.

CLUTCH

Checking operation of clutch

- Pull the clutch lever.
 - » An increase in force with increasing actuation must be perceptible.

If no increase in force with increasing actuation is perceptible:

- Have the clutch checked by a specialist workshop, preferably an authorised BMW Motorrad retailer.

Checking the clutch play

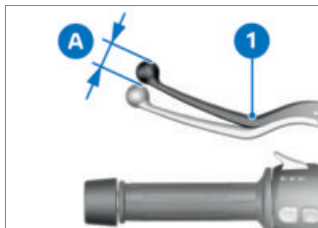

- Repeatedly pull clutch lever **1** tight against the grip.
- Pull clutch lever **1** gently until resistance is perceptible, observing the clutch play **A**.



Clutch cable play

3...5 mm (at the outer end of the handlebar lever, handlebars in straight-ahead position, engine cold)

Clutch play is out of tolerance:

- Adjust the clutch play (▶▶▶ 173).

Adjusting clutch play

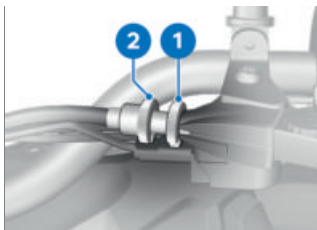

- Loosen lock nut **1**.
- To increase clutch play: Tighten adjusting screw **2** into the handlebar fitting.
- To reduce clutch play: Back off adjusting screw **2** in the handlebar fitting.



The distance between lock nut and nut (measured internally) must not exceed 14 mm.

Consult a specialist workshop, preferably an authorised BMW Motorrad Retailer, should it only be possible to

174 MAINTENANCE

set the correct clutch play by unscrewing further.

- Checking the clutch play (▣▣▣▣▶ 173).
- Tighten lock nut **1** while holding adjusting screw **2**.

COOLANT

Checking coolant level

- Make sure the ground is level and firm and place the motorcycle on its stand.

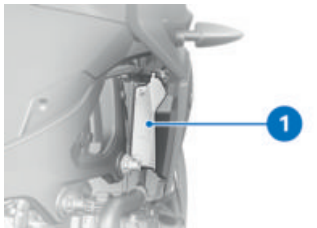

- Check the coolant level in expansion tank **1**. Viewing direction: from behind through opening in right-hand side trim panel.



Specified coolant level

Between **MIN** and **MAX** marks on the expansion tank (Engine cold)

If the coolant drops below the permitted level:

- Top up the coolant.

Topping up coolant

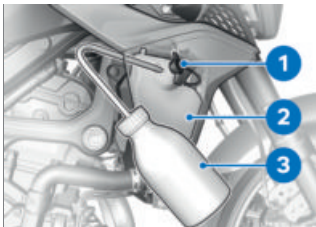

- Open cap **1** of expansion tank **2**.
- Using a suitable container such as a laboratory flask **3**, top up the coolant to the specified level.
- Check the coolant level (▣▣▣▣▶ 174).

- Close cap **1** of expansion tank **2**.

TYRES

Checking tyre pressures



WARNING

Incorrect tyre pressure

Impaired handling characteristics of the motorcycle, shorter useful tyre life

- Always check that the tyre pressures are correct.



WARNING

Tendency of valve inserts installed vertically to open by themselves at high riding speeds

Sudden loss of tyre pressure

- Install valve caps fitted with rubber sealing rings and tighten firmly.
- Make sure the ground is level and firm and place the motorcycle on its stand.
- Check tyre pressures against the data below.



Tyre pressure, front

2.5 bar (tyre cold)



Tyre pressure, rear

2.9 bar (tyre cold)

If tyre pressure is too low:

- Correct tyre pressure.

Checking tyre tread depth



WARNING

Riding with badly worn tyres

Risk of accident due to impaired handling

- If applicable, have the tyres changed in good time before they wear to the minimum tread depth permitted by law.
 - Make sure the ground is level and firm and place the motorcycle on its stand.
 - Measure the tyre tread depth in the main tread grooves with wear marks.
-  Wear indicators are built into the main profile grooves on each tyre. The tyre is worn out when the tyre tread has worn down to the level of the marks. The locations of the marks are indicated on the edge of the tyre, e.g. by the letters TI, TWI or by an arrow.

176 MAINTENANCE

If the tyre tread is worn to minimum:

- Replace tyre or tyres, as applicable.

WHEEL RIMS

Checking rims

- Place the motorcycle on its stand on firm, even ground.
- Visually inspect the rims for defects.
- Have damaged rims inspected by a specialist workshop and replaced if necessary, preferably by an authorised BMW Motorrad Retailer.

WHEELS

Tyre recommendation

For each size of tyre, BMW Motorrad tests and classifies as roadworthy certain makes. BMW Motorrad cannot assess the suitability or provide any guarantee of road safety for other tyres.

BMW Motorrad recommends using only tyres tested by BMW Motorrad.

Detailed information is available from your authorised BMW Motorrad retailer or online from

bmw-motorrad.com/service

Effect of wheel size on chassis and suspension control systems

Wheel size is very important as a parameter for the suspension control systems. In particular, the diameter and the width of a vehicle's wheels are programmed into the control unit and are fundamental to all calculations. Any change in these influencing variables, caused for example by a switch to wheels other than those installed ex-works, can have serious effects on the performance of the control systems.

The sensor rings are essential for correct road-speed calculation, and they too must match the motorcycle's control systems and consequently cannot be changed.

If you decide that you would like to fit non-standard wheels to your motorcycle, it is very important to consult a specialist workshop beforehand, preferably an authorised BMW Motorrad retailer. In some cases, the data programmed into the control units can be changed to suit the new wheel sizes.

Removing front wheel

- Make sure the ground is level and firm and place the motorcycle on its stand.

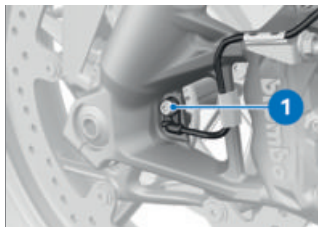

- Remove screw **1** and remove the wheel speed sensor from its bore.

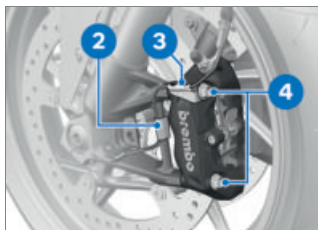

- Disengage the cable for the wheel speed sensor from holding clips **2** and **3**.
- Remove mounting bolts **4** from the left and right brake calipers.

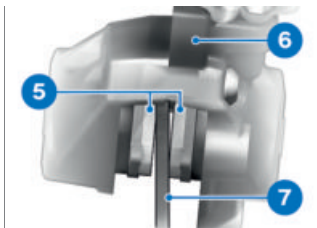

- Force brake pads **5** slightly apart by rocking brake caliper **6** back and forth against brake disc **7**.



ATTENTION

Use of hard or sharp-edged objects in proximity to component

Component damage

- Take care not to scratch components; cover or mask as necessary.
- Mask off the parts of the wheel rim that could be scratched in the process of removing the brake calipers.

ATTENTION

Unwanted inward movement of the brake pads

Component damage on attempt to install the brake caliper or because brake pads have to be forced apart

- Do not operate the brakes with a brake caliper not correctly secured.
- Carefully pull the brake calipers back and out until clear of the brake discs.
- Place the motorcycle on a suitable auxiliary stand.
- Install the rear-wheel stand (▣▣▣ 166).
–with centre stand^{OE}
- Make sure the ground is level and firm and place the motorcycle on its centre stand.◁
- Raise front of motorcycle until the front wheel can turn freely. Use a suitable front-wheel stand to lift the front of the motorcycle.
- Install the front-wheel stand (▣▣▣ 165).

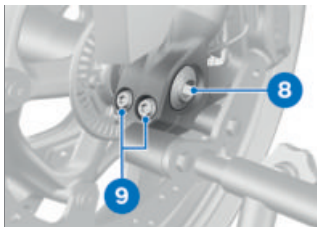

- Remove axle screw **8**.
- Slacken left axle clamping screws **9**.

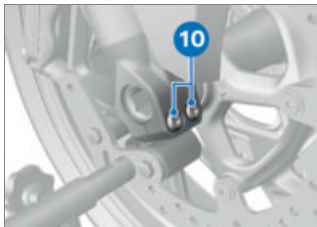

- Slacken right axle clamping screws **10**.

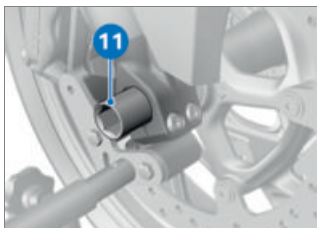

- Remove axle **11**, while supporting the wheel.
- Do not remove the grease from the axle.

- Roll the front wheel forward to remove.

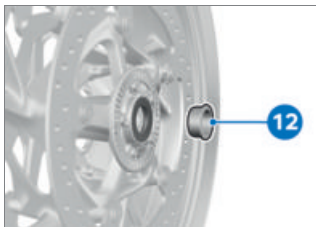

- Remove spacing bushing **12** from the left-hand side of the wheel hub.

Installing front wheel



WARNING

Use of a non-standard wheel

Malfunctions during ABS and ASC/DTC intervention

- See the information on the effect of wheel size on the ABS and ASC/DTC systems at the start of this chapter.



ATTENTION

Tightening threaded fasteners to incorrect tightening torque

Damage, or threaded fasteners work loose

- Always have the security of the fasteners checked by a specialist workshop, preferably an authorised BMW Motorrad dealer.



- Lubricate the running surface of spacer bush **12**.



Lubricant

Unirex N3

- Slip spacer bushing **12**, turned with the collar facing out, on to the wheel hub on the left-hand side.

180 MAINTENANCE



ATTENTION

Front wheel installed wrong way round

Risk of accident

- Note direction-of-rotation arrows on tyre or rim.
- Roll the front wheel into position between the forks of the front suspension.

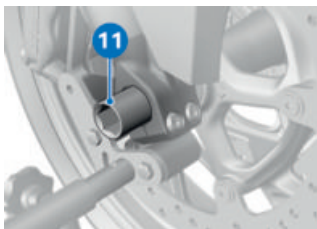

- Lubricate the quick-release axle **11**.



WARNING

Improper installation of the quick-release axle

Loosening of the front wheel

- After securing the brake calipers and relieving the front forks, tighten the quick-release axle and the axle clamping to the specified tightening torque.

- Raise the front wheel and insert quick-release axle **11** until seated.
- Remove front-wheel stand and firmly compress front forks several times. Do not operate the brake lever in this process.
- Install the front-wheel stand (▶▶▶ 165).

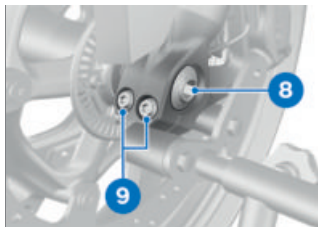

- Install axle screw **8** and tighten to the specified torque. In this process, counter-hold the quick-release axle on the right side.



Axle screw in front quick-release axle

M20 x 1.5

50 Nm

- Tighten left axle clamping screws **9** to the specified torque.



 Clamp of quick-release axle

Tightening sequence: Tighten screws six times in alternate sequence

M8 x 35

19 Nm



 Clamp of quick-release axle

Tightening sequence: Tighten screws six times in alternate sequence

M8 x 35

19 Nm

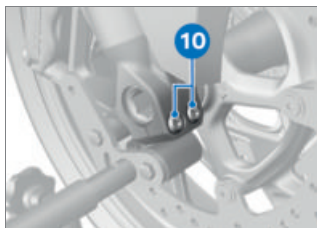

- Tighten right axle clamping screws **10** to the specified tightening torque.

- Position left and right brake calipers on the brake discs.

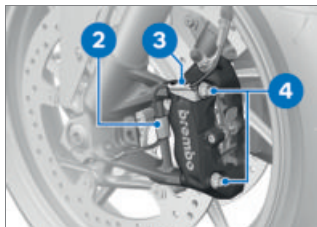

- Tighten mounting bolts **4** of the left and right brake calipers to the specified torque.

 Brake caliper to telescopic fork

M10 x 65

38 Nm

182 MAINTENANCE

- Remove the adhesive tape from the wheel rim.



WARNING

Brake pads not lying against the brake disc

Risk of accident due to delayed braking effect.

- Before driving, check that the brakes respond without delay.
- Operate the brake several times until the brake pads are bedded.
- Seat the cable for the wheel-speed sensor in holding clips **2** and **3**.

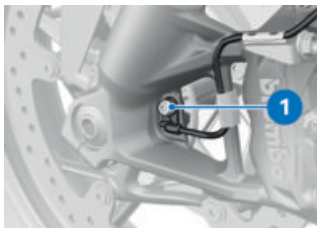

- Insert the wheel speed sensor into the bore and tighten **new** screw **1** to the specified torque.



Wheel-speed sensor, front, to fork leg

M6 x 16



Wheel-speed sensor, front, to fork leg

Thread-locking compound: micro-encapsulated

8 Nm

- Remove the front-wheel stand.
- without centre stand^{OE}
- Remove the auxiliary stand.
- Place the motorcycle on its side stand.◁

Removing rear wheel



ATTENTION

Unwanted inward movement of the brake pads

Component damage on attempt to install the brake caliper or because brake pads have to be forced apart

- Do not operate the brakes with a brake caliper not correctly secured.
- Make sure the ground is level and firm and place the motorcycle on a suitable auxiliary stand.
- Install the rear-wheel stand (▮▮▮ 166).
- with centre stand^{OE}
- Make sure the ground is level and firm and place the motorcycle on its centre stand.◁

- Slip wooden chocks or similar under the rear wheel to prevent it from dropping out after the quick-release axle has been removed.

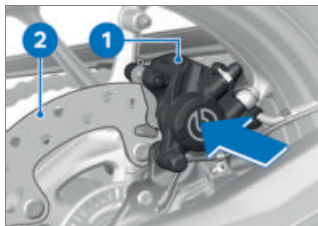

- Press the brake caliper **1** against the brake disc **2**.
» Brake pistons are pushed back.

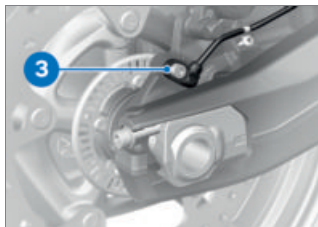

- Remove screw **3** and remove the wheel speed sensor from its bore.

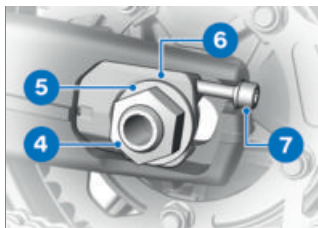

- Remove axle nut **4** and washer **5**.
- Back off adjusting screws **7** on both sides.
- Remove chain tensioner **6** and push the axle forward as far as it will go.

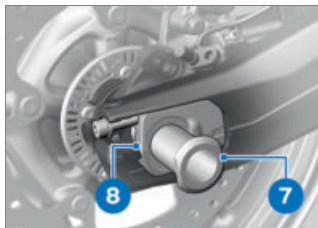

- Remove quick-release axle **7** and remove chain tensioner **8**.

184 MAINTENANCE



- Roll the rear wheel as far forward as possible and disengage chain **9** from the sprocket.

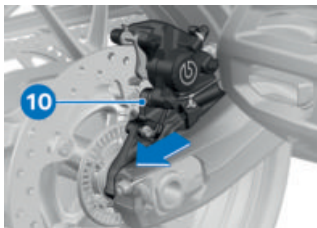

- Roll the rear wheel to the rear and clear of the swinging arm and at the same time pull brake-caliper carrier **10** back far enough to allow the rear wheel to clear it.

 The sprocket and the spacer bushes on left and right are loose fits in the wheel. Make sure that these parts are not damaged or get lost on removal.

Installing rear wheel

WARNING

Use of a non-standard wheel
Malfunctions during ABS and ASC/DTC intervention

- See the information on the effect of wheel size on the ABS and ASC/DTC systems at the start of this chapter.

ATTENTION

Tightening threaded fasteners to incorrect tightening torque

Damage, or threaded fasteners work loose

- Always have the security of the fasteners checked by a specialist workshop, preferably an authorised BMW Motorrad dealer.
- Roll the rear wheel on the support into the swinging arm as far as necessary to permit the brake-caliper carrier to be inserted.

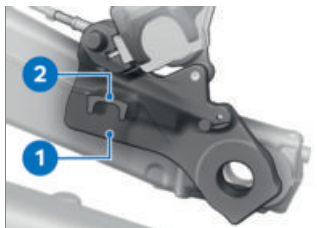

- Insert the brake-caliper carrier **1** into guide **2**.



- Roll the rear wheel as far forward as possible and loop chain **7** over the sprocket.



- Roll the rear wheel farther into the swinging arm, while pushing brake-caliper carrier **1** forward at the same time.

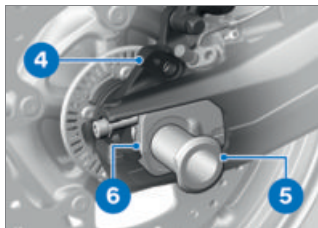

- Insert right chain tensioner **6** into the swinging arm.
- Lubricate quick-release axle **5** and install it in brake-caliper carrier **4** and the rear wheel.



Lubricant

Unirex N3

- Make sure that the axle fits into the recess of the chain tensioner.

186 MAINTENANCE

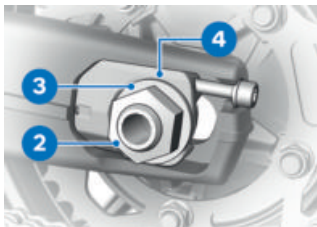

- Insert left chain tensioner **4**.
- Install washer **3** and axle nut **2**, but do not tighten yet.

–without centre stand^{OE}

- Remove the auxiliary stand.◁

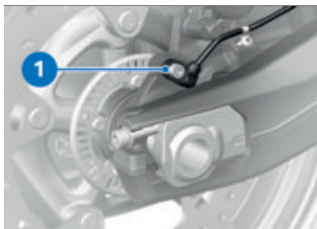

- Insert the wheel speed sensor into the bore and tighten **new** screw **1** to the specified torque.



Wheel-speed sensor,
rear, to brake caliper
carrier

M6 x 16

Thread-locking compound:
micro-encapsulated

8 Nm

WARNING

Brake pads not lying against the brake disc

Risk of accident due to delayed braking effect.

- Before driving, check that the brakes respond without delay.

- After completing work, operate the brake several times until the brake pads are bedded.
- Check the chain tension (▮▮▮▮▶ 187).
- Adjust the chain tension (▮▮▮▮▶ 187).

CHAIN

Lubricating chain

ATTENTION

Inadequate cleaning and lubrication of the drive chain

Accelerated wear

- Clean and lubricate the drive chain at regular intervals.

- Lubricate the drive chain every third fuel stop.
- Lubricate the chain more frequently if the motorcycle is ridden in wet, dusty or dirty conditions.

- Switch the ignition off and select neutral.
- Clean the drive chain with a suitable cleaning product, dry it and apply chain lubricant.
- To prolong chain life, BMW Motorrad recommends the use of BMW Motorrad chain lubricant, or:

 Lubricant
Chain spray, O-ring compatible

- Wipe off excess lubricant.

Checking chain tension

- Make sure the ground is level and firm and place the motorcycle on its stand.
- Turn the rear wheel until it reaches the position of least chain sag.

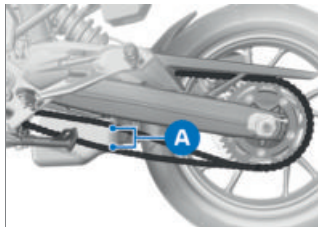

- Use a screwdriver to push the chain up and down at a point midway between the pinion and sprocket and measure difference **A**.



Chain deflection

35...45 mm (Motorcycle with no weight applied, supported on its side stand)

–with low-slung^{OE}

30...40 mm (Motorcycle with no weight applied, supported on its side stand) <

If measured value is outside permitted tolerance:

- Adjust the chain tension (→ 187).

Adjusting chain tension

- Make sure the ground is level and firm and place the motorcycle on its stand.

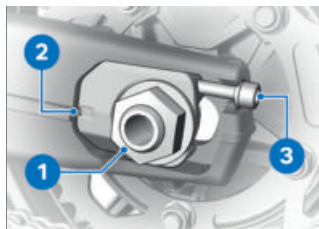

- Loosen the axle nut **1**.
- Use adjusting screws **3** on left and right to adjust chain tension.
- Check the chain tension (→ 187).
- Make sure that scale readings **2** are the same on left and right.

188 MAINTENANCE

- Tighten quick-release axle nut **1** to the specified torque.



Rear quick-release axle in swinging arm

M24 x 1.5

Thread-locking compound: mechanical

100 Nm



- Check whether the third marker line **1** can be fully seen.

Check chain length if the third marker line **1** can be fully seen:

- Engage 1st gear.
- Turn the rear wheel in the normal direction of travel until the chain is tensioned.
- Measure the length of the chain, rivet centre to rivet centre, over 10 rivets below the rear wheel swinging arm.
- Turn the rear wheel in the forward direction of travel and measure chain length at 3 different points.

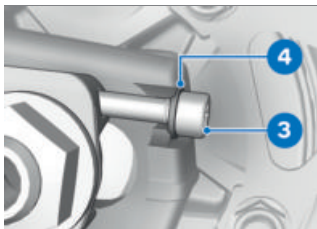

- Check that the washer **4** is lying flat against the screw head **3**, correct as necessary.

Checking chain wear Requirement

Chain tension is correct.

- Make sure the ground is level and firm and place the motorcycle on its stand.



Permissible chain length

max 144 mm (measured from the **centre** of 10 rivets, chain pulled taut)

If the chain has stretched to the maximum permissible length:

- Consult a specialist workshop, preferably an authorised BMW Motorrad retailer.

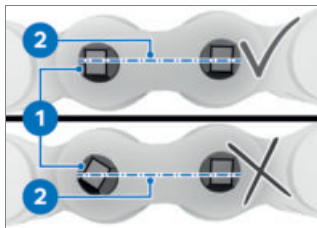

- Check whether a rivet head **1** has twisted out of line.

Rivet heads are parallel to the chain centreline **2**.

- Chain riveting is OK.

If one or more rivet heads have twisted out of line:

- Consult a specialist workshop, preferably an authorised BMW Motorrad retailer.

LIGHTING

Replacing LED light sources



WARNING

Vehicle overlooked in traffic due to failure of the lights on the vehicle

Safety risk

- Always replace a faulty bulb at the earliest possible opportunity. Consult a specialist workshop, preferably an authorised BMW Motorrad Retailer.

All light sources of the vehicle are LED light sources. The service life of the LED light sources is longer than the presumed vehicle service life. If an LED light source is faulty contact a specialist workshop, preferably an authorised BMW Motorrad retailer.

190 MAINTENANCE

JUMP-STARTING

CAUTION

Touching live parts of the ignition system when the engine is running

Electric shock

- Do not touch parts of the ignition system when the engine is running.

ATTENTION

Excessive current flowing when the motorcycle is jump-started

Wiring smoulders/ignites or damage to the on-board electronics

- If the motorcycle has to be jump-started connect the leads to the battery terminals; never attempt to jump-start the engine by connecting leads to the on-board socket.

ATTENTION

Contact between crocodile clips of jump leads and vehicle

Risk of short-circuit

- Use jump leads fitted with fully insulated crocodile clips at both ends.

ATTENTION

Jump-starting with a voltage greater than 12 V

Damage to the on-board electronics

- Make sure that the battery of the donor vehicle has a voltage rating of 12 V.
- Remove the seat (→ 90).
- When jump-starting the engine, do not disconnect the battery from the on-board electrical system.

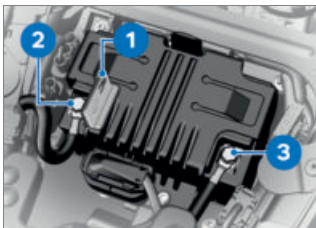

- Press in the lock and flip open positive terminal cover **1**.

- Begin by connecting one end of the red jump lead to the positive terminal of the discharged battery and the other end to the positive terminal of the donor battery (positive terminal on this vehicle: position **2**).
- Then connect one end of the black jump lead to the negative terminal of the donor battery and the other end to the negative terminal of the discharged battery (negative terminal on this vehicle: position **3**).



The spring-strut screw can be used as an alternative to the battery's negative terminal.

- Run the engine of the donor vehicle during jump-starting.
- Start the engine of the vehicle with the discharged battery in the usual way; if the engine does not start, wait a few minutes before repeating the attempt in order to protect the starter motor and the donor battery.
- Allow both engines to idle for a few minutes before disconnecting the jump leads.
- Disconnect the jump lead from the negative terminals first, then disconnect the

second lead from the positive terminals.



Do not use proprietary start-assist sprays or other products to start the engine.

- Install the seat (▣▣▣ 91).

BATTERY

Maintenance instructions

Correct upkeep, recharging and storage will prolong the life of the battery and are essential if warranty claims are to be considered.

Compliance with the points below is important in order to maximise battery life:

- Keep the surface of the battery clean and dry.
- Do not open the battery.
- Do not top up with water.
- Be sure to read and comply with the instructions for charging the battery on the following pages.
- Do not turn the battery upside down.



ATTENTION

On-board electronics (e.g. clock) draining connected battery

Battery is deep-discharged; this voids the guarantee

- Connect a float charger to the battery if the motorcycle is to remain out of use for more than four weeks.



ATTENTION

Charging the battery that is connected to the vehicle via the battery terminals

Damage to the on-board electronics

- Disconnect the battery at the battery terminals before charging.



BMW Motorrad has developed a float charger specially designed for compatibility with the electronics of your motorcycle. Using this charger, you can keep the battery charged during long periods of disuse, without having to disconnect the battery from the motorcycle's on-board systems. You can obtain additional information from your authorised BMW Motorrad dealer.

Charging battery when connected

- Disconnect devices plugged into the sockets.



ATTENTION

Unsuitable chargers connected to a socket

Damage to charger and vehicle electronics

- Use suitable BMW chargers. The suitable charger is available from your authorised BMW Motorrad dealer.

**ATTENTION****Recharging a fully discharged battery via the power socket or extra socket**

Damage to the vehicle electronics

- If a battery has discharged to the extent that it is completely flat (battery voltage less than 12 V, indicator lights and multifunction display remain off when the ignition is switched on) always charge the **disconnected** battery with the charger connected directly to the battery terminals.

- With the battery connected to the vehicle's on-board electrical system, charge via the power socket.

 The motorcycle's on-board electronics know when the battery is fully charged. The on-board socket is switched off when this happens.

- Comply with the operating instructions of the charger.

 If you are unable to charge the battery through the on-board socket, you may be using a charger

that is not compatible with your motorcycle's electronics. In this case, directly charge the battery at the terminals of the battery that has been disconnected from the vehicle.

Charging battery when disconnected

- Charge the battery using a suitable charger.
- Comply with the operating instructions of the charger.
- After charging, disconnect the charger's terminal clips from the battery terminals.



The battery has to be recharged at regular intervals in the course of a lengthy period of disuse. See the instructions for caring for your battery. Always fully recharge the battery before restoring it to use.

Removing battery

- Make sure the ground is level and firm and place the motorcycle on its stand.
- Remove the seat ( 90).
–with anti-theft alarm (DWA)^{OE}
- If applicable, switch off the anti-theft alarm. ◁
- Switch off the ignition.

194 MAINTENANCE



ATTENTION

Battery not disconnected in accordance with correct procedure

Risk of short-circuit

- Always proceed in compliance with the specified disconnection sequence.
- First disconnect negative battery cable **1**.
- Press in the lock and flip open positive terminal cover **5**.
- Then disconnect positive battery cable **4**.
- Disconnect connector **3**.
- Remove screw **2**.
- Push lock **6** to the rear.
- Remove battery holder **7**.
- Lift the battery up and out; work it slightly back and forth if it is difficult to remove.

Installing battery

 If the vehicle has been disconnected from the battery for a significant time, the current date will have to be entered in the instrument cluster to guarantee correct operation of the service display.

- Switch off the ignition.
- Insert the battery into the battery compartment, with the positive terminal on the right in the direction of travel.



- Hold battery holder **7** in position. Holder **6** engages with an audible click.
- Install screw **2**.
- Connect connector **3**.
- Flip open positive terminal cover **5**.

ATTENTION

Battery not connected in accordance with correct procedure

Risk of short-circuit

- Always proceed in compliance with specified installation sequence.

- Connect positive battery cable **4**.
- Close positive terminal cover **5**.

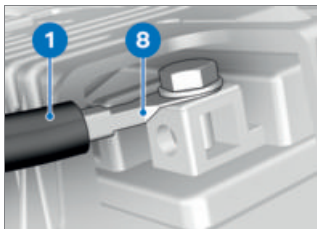

- Connect negative battery cable **1** aligned in direction **8**.
- with anti-theft alarm (DWA)^{OE}
- If applicable, switch on the anti-theft alarm.◁
 - Install the seat (▮▮▮ 91).
 - Set the clock (▮▮▮ 103).
 - Set the date (▮▮▮ 102).



FUSES

Replacing main fuse

ATTENTION

Jumpering of blown fuses

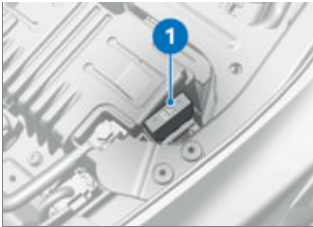
Risk of short-circuit and fire

- Never attempt to jumper a blown fuse.
 - Always replace a defective fuse with a new fuse of the same amperage.
- Switch off the ignition.
 - Make sure the ground is level and firm and place the motorcycle on its stand.
 - Remove the seat (▮▮▮ 90).
- 
- Replace blown fuse **1**.
-  If fuse defects recur frequently have the electric circuits checked by a specialist workshop, preferably an authorised BMW Motorrad dealer.

196 MAINTENANCE



Main fuse

40 A (Voltage regulator)

- Install the seat (➔ 91).

Replacing fuses

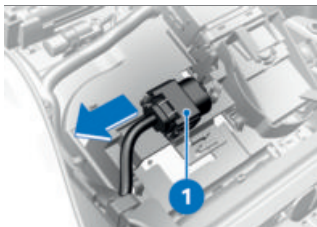

- Switch off the ignition.
- Remove the seat (➔ 90).
- Remove fuse box **1**.

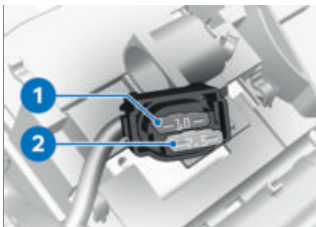

ATTENTION

Jumping of blown fuses

Risk of short-circuit and fire

- Never attempt to jumper a blown fuse.
- Always replace a defective fuse with a new fuse of the same amperage.

- Consult the fuse assignment diagram and replace blown fuse **1** or **2**.



If fuse defects recur frequently have the electric circuits checked by a specialist workshop, preferably an authorised BMW Motorrad dealer.



Fuse box

10 A (Slot 1: instrument cluster, alarm system (DWA), ignition lock, diagnostic socket, coil main relay)



Fuse box

7.5 A (Slot 2: multifunction switch left, tyre pressure control (RDC))

- Insert the fuse box.
- Install the seat (▣▣▣ 91).

DIAGNOSTIC CONNECTOR

Disengaging diagnostic socket



CAUTION

Incorrect disconnection of the diagnostic socket for on-board diagnosis

Malfunctions of the vehicle

- Do not disconnect the diagnostic socket or allow it to be disconnected except in the course of a BMW Motorrad service by a specialist workshop or by other authorised persons.
- Have the work carried out by appropriately trained personnel.
- Comply with the stipulations of the vehicle manufacturer.

- Remove the seat (▣▣▣ 90).

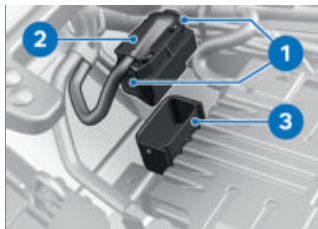

- Press locks **1** on both sides.
 - Disengage diagnostic socket **2** from holder **3**.
- » The interface to the diagnosis and information system can be connected to the diagnostic connector **2**.

Securing diagnostic socket

- Disconnect the interface for the diagnosis and information system.

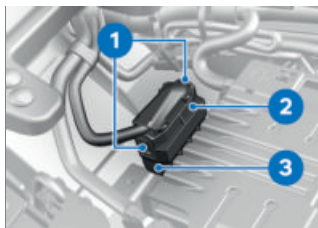

- Insert diagnostic socket **2** into holder **3**.
- » The locks **1** engage.
- Install the seat (▣▣▣ 91).

ACCESSORIES

10

GENERAL NOTES	200
POWER SOCKETS	200
SOFT CASES	201
TOPCASE	202
NAVIGATION SYSTEM	205

GENERAL NOTES



CAUTION

Use of other-make products

Safety risk

- BMW Motorrad cannot examine or test each product of outside origin to ensure that it can be used on or in connection with BMW vehicles without constituting a safety hazard. Country-specific official authorisation does not suffice as assurance. Tests conducted by these instances cannot make provision for all operating conditions experienced by BMW vehicles and, consequently, they are not sufficient in some circumstances.
- Use only parts and accessories approved by BMW for your vehicle.

BMW has conducted extensive testing of the parts and accessory products to establish that they are safe, functional and suitable. Consequently, BMW accepts responsibility for the products. BMW accepts no liability whatsoever for parts and accessories that it has not approved.

All modifications must be in compliance with legal requirements. Make sure that the vehicle does not infringe the national road-vehicle construction and use regulations applicable in your country. Your authorised BMW Motorrad retailer can offer expert advice on the choice of genuine BMW parts, accessories and other products. To find out more about accessories go to:

bmw-motorrad.com/equipment

POWER SOCKETS

Notes on use of power sockets:

Automatic shutdown

Power sockets are shut down automatically under the following circumstances:

- If battery charge state is too low to maintain the motorcycle's start capability.
- If the maximum load capacity as stated in the technical data is exceeded.
- During the starting operation.

Operating electrical accessories

You can start using electrical accessories connected to the motorcycle's sockets only when the ignition is switched on. The

accessory remains operational if the ignition is subsequently switched off. The power sockets are switched off approximately 15 minutes after the ignition is switched off, in order to prevent overloading of the on-board electrical system. Low-wattage electrical accessories might not be recognised by the vehicle's electronics. In such cases, power sockets are switched off very shortly after the ignition is turned off.

Cable routing

Note the following with regard to the routing of cables from sockets to items of electrical equipment:

- Make sure that cables do not impede the rider.
- Make sure that cables do not restrict the steering angle or obstruct handling.
- Make sure that cables cannot be trapped.

SOFT CASES

Installing soft cases

- with case holder, left/right^{OE}
- with case^{OA}

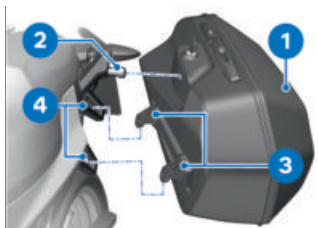

- Lower soft case **1** from above until retaining lugs **3** engage holders **4** and seat the case against latch **2**.



- Turn key **1** in the direction opposite to the direction of travel and push the soft case into the latch.
- » Soft case snaps into engagement with the latch.

Removing soft cases

- with case holder, left/right^{OE}
- with case^{OA}

202 ACCESSORIES



- Turn key **1** in the direction opposite to the direction of travel.

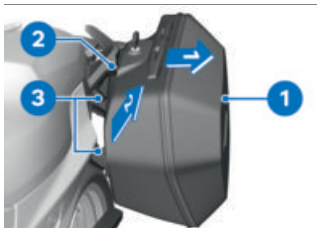

- Ease soft case **1** in direction of arrow **1** until it disengages from latch **2**. Then lift soft case **1** in direction of arrow **2** and disengage it from retaining lugs **3**.

Maximum payload and maximum speed

- with case holder, left/right^{OE}
- with case^{OA}

Note the maximum payload and the maximum permissible speed.



Maximum permissible speed for riding with cases fitted to the motorcycle

max 180 km/h



Payload per case

max 5 kg

TOPCASE

Opening topcase

- with topcase^{OA}
- with luggage carrier^{OA}

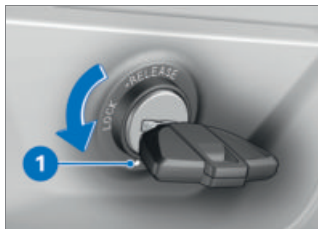

- Turn the key in the topcase lock to position **1**.



- Push lock barrel **1** forward.
» Release lever **2** pops up.
- Pull release lever **2** all the way up and open the lid of the topcase.

Closing topcase

- with topcase^{OA}
- with luggage carrier^{OA}



- Pull release lever **1** all the way up.
- Close the lid of the topcase and hold it down. Check that nothing is trapped between the lid and the case.

 The topcase can also be closed when the lock is in the **LOCK** position. Make sure

that the ignition key is not left inside the topcase.



- Push release lever **1** down until it engages.
- Turn the key in the topcase lock to the **LOCK** position and remove the key from the lock.

Removing topcase

- with topcase^{OA}
- with luggage carrier^{OA}

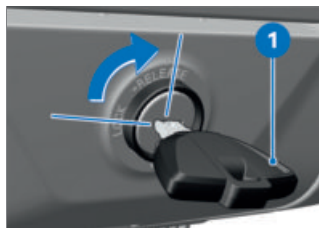

- Turn key **1** clockwise to the **RELEASE** position.
» The handle pops out.

204 ACCESSORIES



- Pull carry handle **1** up as far as it will go.
- Lift the topcase at the rear and remove it from the luggage carrier.

Installing topcase

–with topcase^{OA}

–with luggage carrier^{OA}

- Pull the carry handle up as far as it will go.



- Hook the topcase into position on the luggage carrier. Make sure that hooks **1** are securely seated in corresponding keepers **2**.



- Push carry handle **1** down until it engages.
- Turn the key in the topcase lock to the **LOCK** position and remove the key from the lock.

Maximum payload and maximum speed

–with topcase^{OA}

–with luggage carrier^{OA}

Note the maximum payload and the maximum permissible speed.



Maximum speed for riding with a loaded topcase

max 180 km/h



Payload of topcase

max 5 kg

NAVIGATION SYSTEM

–with preparation for navigation system^{OE}

Securing navigation device

 Navigation preparation is suitable from BMW Motorrad Navigator IV.

 The latching system of the Mount Cradle is not designed to protect against theft.

Always remove the navigation system and stow it away safely as soon as you finish your ride.



- Turn ignition key **1** counter-clockwise.
- Pull the lock retainer **2** to the **left**.
- Press the lock **3** in.
 - » The Mount Cradle is unlocked and cover **4** can be pivoted forward and removed.

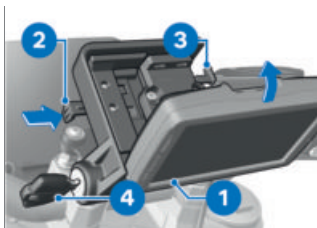

- Insert navigation device **1** at bottom and pivot it toward the rear.
 - » The navigation device engages with an audible click.
- Push the lock retainer **2** all the way to the **right**.
 - » Lock **3** is locked.
- Turn ignition key **4** clockwise.
 - » The navigation device is secured and the ignition key can be removed.

Removing navigation device and installing cover

ATTENTION

Dust and dirt on the Mount Cradle contacts

Damaged contacts

- Always reinstall the cover as soon as you finish your ride.

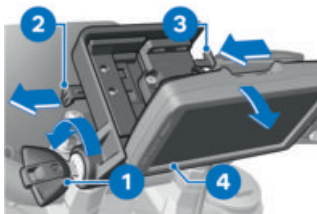

- Turn ignition key **1** counter-clockwise.
- Pull the lock retainer **2** all the way to the **left**.
 - » Lock **3** is unlocked.
- Push lock **3** all the way to the **left**.
 - » The navigation device **4** is unlocked.
- Tilt the navigation device **4** down and remove.





- Insert cover **1** in the lower section and swing to the top with a rotational movement.
 - » The cover engages with an audible click.
- Push lock retainer **2** to the **right**.

- Turn ignition key **3** clockwise.
 - » The cover **1** is secured.

Operating navigation system

 The description below is based on the BMW Motorrad Navigator V and the BMW Motorrad Navigator VI. The BMW Motorrad Navigator IV does not support all the options described here.

 Only the latest version of the BMW Motorrad communication system is supported. A software update of the BMW Motorrad communication system may be necessary. If this is the case, consult your authorised BMW Motorrad dealer.

If the BMW Motorrad Navigator is installed and the operating focus is switched to the Navigator ( 99), some of its functions can be operated without the rider removing a hand from the handlebars.

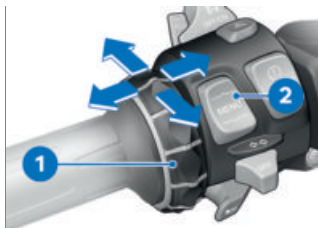

The navigation system is operated using Multi-Controller 1 and MENU rocker button 2.

Turning Multi-Controller 1 up and down

On the Compass and Mediaplayer pages: Increase or decrease the volume of a Bluetooth-connected BMW Motorrad communication system.

In the BMW special menu: Select menu item.

Short-tilting Multi-Controller 1 to the left and right

Switch between the main pages of the Navigator:

- Map view
- Compass
- Mediaplayer
- BMW special menu
- My Motorcycle page

Long-tilting Multi-Controller 1 to the left and right

Activate certain functions on the Navigator display. An arrow to the right or to the left above the corresponding button area on the display indicates a function that can be activated in this way.

 Long-push to the right to activate this function.

 Long-push to the left to activate this function.

Pressing bottom section of MENU rocker button 2

Switch operating focus to Pure Ride view.

In detail, the following functions can be controlled:

Map view

- Turn up: Zoom in.
- Turn down: Zoom out.

BMW special menu

- Speak: Repeat most recent navigation announcement.
- Waypoint: Save current location as a favourite.
- Home: Starts navigation to home address (greyed if no home address has been defined).
- Mute: Switch automatic navigation announcements off

208 ACCESSORIES

or on (off: a crossed-out lips symbol appears in the top line of the display). "Speak" will still activate navigation announcements. All other acoustic outputs remain switched on.

- Switch off display: Deactivate the display.
- Dial home number: Dials the home phone number saved in the Navigator (not shown unless a telephone is connected).
- Diversion: Activates the diversion function (not shown unless a route is active).
- Skip: Skips the next waypoint (not shown unless the route has waypoints).

My Motorcycle

- Turn: Changes the number of data shown.
- Touch a data field on the display to open the menu for selecting data.
- The values available for selection depend on the optional extras installed on the vehicle.

 The Mediaplayer function is only available when a Bluetooth device complying with the A2DP standard is used, for example a BMW Motorrad communication system.

Mediaplayer

- Long-push to the left: Play preceding track.
- Long-push to the right: Play next track.
- Turning increases or decreases the volume of a BMW Motorrad communication system connected via Bluetooth.

Indicator and warning messages

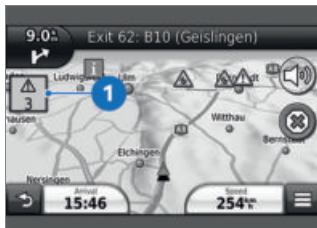

Indicator and warning messages from the motorcycle are indicated by an appropriate symbol **1** which appears at the top left in the map view.

 If a BMW Motorrad communication system is connected, warnings are accompanied by an acoustic signal.

If there are two or more active warnings the number appears below the warning triangle. Touching the warning triangle when more than one warning

is active opens a list of all the warnings. Additional information appears as soon as a message is selected.



Detailed information cannot be displayed for all warnings.

Special functions

Integration of the BMW Motorrad Navigator has produced a number of deviations from the descriptions in the operating instructions for the Navigator.

Reserve fuel level warning

The settings for the fuel gauge are not available, because the reserve warning is transmitted from the vehicle to the Navigator. Touch the message when it is active to view the locations of the nearest filling stations.

Security settings

The BMW Motorrad Navigator V and the BMW Motorrad Navigator VI can be secured against unauthorised use with a four-digit PIN (Garmin Lock). If this function is activated, while the Navigator is cradled on the vehicle and the ignition is switched on you are prompted to add the vehicle to the list of secured vehicles. If you an-

swer "Yes" at this prompt, the Navigator saves the VIN of this vehicle in its internal memory. A maximum of five VINs can be saved in this way.

It is then no longer necessary to enter the PIN when the Navigator is switched on by ignition ON on any of these vehicles.

If the Navigator is removed from the vehicle while switched on, a security prompt is issued asking for the PIN to be entered.

Screen brightness

Screen brightness is adjusted by the motorcycle while the unit is cradled. Manual input is not necessary.

Automatic setting can be switched off in the display settings for the Navigator if desired.

CARE

11

CARE PRODUCTS	212
WASHING THE VEHICLE	212
CLEANING EASILY DAMAGED COMPONENTS	213
CARE OF PAINTWORK	214
PAINTWORK PRESERVATION	215
LAYING UP MOTORCYCLE	215
RESTORING MOTORCYCLE TO USE	215

CARE PRODUCTS

BMW Motorrad recommends that you use the cleaning and care products you can obtain from your authorised BMW Motorrad retailer. The substances in BMW Care Products have been tested in laboratories and in practice; they provide optimised care and protection for the materials used in your vehicle.



ATTENTION

Use of unsuitable cleaning and care products

Damage to vehicle parts

- Do not use solvents such as cellulose thinners, cold cleaners, fuel or the like, and do not use cleaning products that contain alcohol.



ATTENTION

Use of strongly acidic or strongly alkaline cleaning agents

Damage to vehicle parts

- Dilute in accordance with the dilution ratio stated on the packaging of the cleaning agent.
- Do not use strongly acidic or strongly alkaline cleaning agents.

WASHING THE VEHICLE

BMW Motorrad recommends that you use BMW insect remover to soften and wash off insects and stubborn dirt on painted parts prior to washing the vehicle.

To prevent stains, do not wash the vehicle immediately after it has been exposed to strong sunlight and do not wash it in the sun.

Remove dirt from the fork legs at regular intervals.

Make sure that the vehicle is washed frequently, especially during the winter months.

To remove road salt, clean the motorcycle with cold water immediately after every trip.

 After a ride in the rain, when humidity is high or after the vehicle has been washed, condensation might form inside the headlight. This can cause temporary fogging on the headlight lens. If moisture is constantly present inside the headlight consult a specialist workshop, preferably an authorised BMW Motorrad retailer.

 **WARNING**

Wet brake discs and brake pads after vehicle wash, after riding through water and in rainy conditions

Diminished braking effect, risk of accident

- Apply the brakes in good time to allow the friction and heat to dry the brake discs and brake pads.

 **ATTENTION**

Effect of road salt intensified by warm water

Corrosion

- Use only cold water to wash off road salt.

 **ATTENTION**

Damage due to high water pressure from high pressure cleaners or steam cleaners

Corrosion or short circuit, damage to labels, seals, hydraulic brake system, electrical system and the motorcycle seat

- Exercise restraint when using a steam jet or high pressure cleaning equipment.

CLEANING EASILY DAMAGED COMPONENTS

Plastics

 **ATTENTION**

Use of unsuitable cleaning agents

Damage to plastic surfaces

- Do not use cleaning agents that contain alcohol, solvents or abrasives.
- Do not use insect-remover pads or cleaning pads with hard, scouring surfaces.

Trim panel components

Clean trim panel components with water and BMW Motorrad solvent cleaner.

214 CARE

Plastic windscreens and headlight lenses

Remove dirt and insects with a soft sponge and plenty of water.

 Soften stubborn dirt and insects by covering the affected areas with a wet cloth.

TFT display

Clean the TFT display with warm water and washing-up liquid. Then dry it with a clean cloth, e.g. a paper towel.

Chrome

Carefully clean chrome parts with plenty of water and motorcycle cleaner from the BMW Motorrad Care Products range. This is particularly important to counter the effects of road salt.

For an additional treatment, use BMW Motorrad metal polish.

Radiator

Clean the radiator regularly to prevent overheating of the engine due to inadequate cooling. For example, use a garden hose with low water pressure.



ATTENTION

Bending of radiator fins

Damage to radiator fins

- Take care not to bend the radiator fins when cleaning.

Rubber

Treat rubber components with water or BMW rubber-care products.



ATTENTION

Application of silicone sprays to rubber seals

Damage to the rubber seals

- Do not use silicone sprays or care products that contain silicon.

CARE OF PAINTWORK

Washing the vehicle regularly will help counteract the long-term effects of substances that can damage the paint, especially if your vehicle is ridden in areas with high air pollution or natural sources of dirt, for example tree resin or pollen. Remove particularly aggressive substances immediately, however, as otherwise the paint can be affected or become discoloured. Substances of this nature include spilt fuel,

oil, grease, brake fluid and bird droppings. For this, we recommend BMW Motorrad solvent cleaner followed by BMW Motorrad gloss polish for preservation.

Marks on the paintwork are particularly easy to see after the motorcycle has been washed. Remove stains of this kind at the earliest possible opportunity, using benzine or petroleum spirit on a clean cloth or ball of cotton wool. BMW Motorrad recommends using BMW tar remover for removing specks of tar. Then apply preserving agent to the areas treated in this way.

PAINTWORK PRESERVATION

If water no longer rolls off the paint, the paint must be preserved.

For paint preservation, BMW Motorrad recommends the use of BMW Motorrad gloss polish or agents containing carnauba wax or synthetic wax.

LAYING UP MOTORCYCLE

- Fill the motorcycle's fuel tank.



Fuel additives clean the fuel injection system and the combustion zone. It is ad-

visable to use fuel additives when the engine is operated with low-grade fuel or if the vehicle is to be out of use for a lengthy period of time. More information is available from your authorised BMW Motorrad retailer.

- Clean the motorcycle.
- Remove the battery.
- Spray the brake and clutch lever pivots and the side stand pivot mounts with a suitable lubricant.
- Coat bright metal and chrome-plated parts with an acid-free grease (e.g. Vaseline).
- Stand the motorcycle in a dry room in such a way that there is no load on either wheel (preferably using the front-wheel and rear-wheel stands from BMW Motorrad).

RESTORING MOTORCYCLE TO USE

- Remove the protective wax coating.
- Clean the motorcycle.
- Install the battery.
- Comply with checklist (📄▶ 129).

TECHNICAL DATA

12

TROUBLESHOOTING CHART	218
THREADED FASTENERS	220
FUEL F 900 R (0K11)	221
FUEL F 900 R A2 (0K31)	222
ENGINE OIL	222
ENGINE F 900 R (0K11)	223
ENGINE F 900 R A2 (0K31)	224
CLUTCH	225
TRANSMISSION	225
FINAL DRIVE	225
FRAME	226
CHASSIS AND SUSPENSION	226
BRAKES	227
WHEELS AND TYRES	227
ELECTRICAL SYSTEM	228
ANTI-THEFT ALARM	229
DIMENSIONS	230
WEIGHTS	230
PERFORMANCE FIGURES	231

218 TECHNICAL DATA

TROUBLESHOOTING CHART

The engine does not start:

Possible cause	Rectification
Side stand extended and gear engaged	Select neutral or retract the side stand.
Gear engaged and clutch not disengaged	Select neutral or pull the clutch lever.
No fuel in tank	Refuel.
Battery flat	Charge the battery when connected.
Starter motor overheating protection has tripped. The starter motor can be operated for a limited time only.	Allow the starter motor to cool down for approximately 1 minute before trying again.

The Bluetooth connection is not established.

Possible cause	Rectification
The steps required for pairing were not carried out.	Check the necessary steps for pairing in the operating instructions for the communication system.
The communication system was not connected automatically despite successful pairing.	Switch off the helmet's communication system and reconnect it after a minute or two.
Too many Bluetooth devices are saved on the helmet.	All pairing entries on the helmet are deleted (see the communication system operating instructions).
There are other vehicles with Bluetooth-capable devices in the vicinity.	Avoid simultaneously pairing with more vehicles.

Bluetooth connection is interrupted.

Possible cause	Rectification
The Bluetooth connection to the mobile device is interrupted.	Switch off energy saving mode.
The Bluetooth connection to the helmet is interrupted.	Switch off the helmet's communication system and reconnect it after a minute or two.
The volume in the helmet cannot be adjusted.	Switch off the helmet's communication system and reconnect it after a minute or two.

The telephone book is not displayed in the TFT display.

Possible cause	Rectification
The phone book was not transmitted to the vehicle.	Confirm transmission of the phone data (☰➔ 114) when pairing the mobile device.

Active route guidance is not displayed in the TFT display.

Possible cause	Rectification
Navigation from the BMW Motorrad Connected app was not transmitted.	The BMW Motorrad Connected app is opened on the connected mobile device prior to departure.
The route guidance cannot be started.	Secure the mobile device's data connection and check the map data on the mobile device.

220 TECHNICAL DATA



THREADED FASTENERS

Front wheel	Value	Valid
Wheel-speed sensor, front, to fork leg		
M6 x 16, Replace screw micro-encapsulated	8 Nm	
Front-wheel cover to telescopic fork		
M5 x 14, Replace screw micro-encapsulated	2 Nm	
Brake caliper to telescopic fork		
M10 x 65	38 Nm	
Clamp of quick-release axle		
M8 x 35	Tightening sequence: Tighten screws six times in alternate sequence	
	19 Nm	
Axle screw in front quick-release axle		
M20 x 1.5	50 Nm	
Rear wheel	Value	Valid
Wheel-speed sensor, rear, to brake caliper carrier		
M6 x 16, Replace screw micro-encapsulated	8 Nm	

Rear wheel	Value	Valid
Rear quick-release axle in swinging arm		
M24 x 1.5 mechanical	100 Nm	



Mirror arm	Value	Valid
Mirror (locknut) to clamping piece		
M10 x 1.25	Left-hand thread, 22 Nm	
Adapter to clamping block		
M10 x 14 - 4.8	25 Nm	

FUEL F 900 R (0K11)

Recommended fuel grade	 Premium unleaded (maximum 15% ethanol, E15)  95 ROZ/RON 90 AKI
-with regular-grade fuel, unleaded ^{OE}	Regular, unleaded (control is national-market-specific) (maximum 15% ethanol, E15) 91 ROZ/RON 87 AKI
Fuel tank capacity	approx. 13 l
Reserve fuel	approx. 3.5 l
Fuel consumption	4.2 l/100 km, in accordance with WMTC
CO2 emission	99 g/km, according to WMTC
Exhaust emissions standard	EU 5
-with Canada export ^{NV}	TIER 2, measured to FTP75

222 TECHNICAL DATA

FUEL F 900 R A2 (0K31)

Recommended fuel grade	 Regular unleaded (maximum 15% ethanol,  E15) 91 ROZ/RON 87 AKI
Fuel tank capacity	approx. 13 l
Reserve fuel	approx. 3.5 l
Fuel consumption	4.2 l/100 km, in accordance with WMTC
CO2 emission	99 g/km, in accordance with WMTC
Exhaust emissions standard	EU 5

ENGINE OIL

Engine oil, capacity	approx. 3.0 l, with filter change
Specification	SAE 5W-40, API SL / JASO MA2, Additives (e.g. molybdenum-based) are not permissible because they can attack coated components of the engine, BMW Motorrad recommends BMW Motorrad ADVANTEC Ultimate oil.

BMW recommends  **ADVANTEC**
ORIGINAL BMW ENGINE OIL
.....

Oil additives	BMW Motorrad recommends not using oil additives, because they can have a detrimental effect on clutch operation. Please do not hesitate to contact your authorised BMW Motorrad retailer if you have any questions relating the choice of a suitable engine oil for your motorcycle.
---------------	--

BMW recommends **ADVANTEC**
ORIGINAL BMW ENGINE OIL

ENGINE F 900 R (0K11)

Engine number location	Crankcase top section, near oil/coolant heat exchanger
Engine type	A24A09A
Engine design	Water-cooled, 2-cylinder 4-stroke engine with four valves per cylinder operated via rocker arms, two overhead camshafts and dry-sump lubrication
Displacement	895 cm ³
Cylinder bore	86 mm
Piston stroke	77 mm
Compression ratio	13.1:1
Nominal capacity	77 kW, at engine speed: 8500 min ⁻¹
–with regular-grade fuel, unleaded ^{OE}	73 kW, (control is national-market-specific) at engine speed: 8500 min ⁻¹

224 TECHNICAL DATA

Torque	92 Nm, at engine speed: 6500 min ⁻¹
-with regular-grade fuel, unleaded ^{OE}	88 Nm, (control is national-market-specific) at engine speed: 6750 min ⁻¹
Maximum engine speed	max 9000 min ⁻¹
Idle speed	1250 ^{±50} min ⁻¹ , Engine at regular operating temperature

ENGINE F 900 R A2 (0K31)

Engine number location	Crankcase top section, near oil/coolant heat exchanger
Engine type	A24A09A
Engine design	Water-cooled, 2-cylinder 4-stroke engine with four valves per cylinder operated via rocker arms, two overhead camshafts and dry-sump lubrication
Displacement	895 cm ³
Cylinder bore	86 mm
Piston stroke	77 mm
Compression ratio	13.1:1
Nominal capacity	70 kW, at engine speed: 8000 min ⁻¹
Torque	88 Nm, at engine speed: 6750 min ⁻¹
Maximum engine speed	max 9000 min ⁻¹
Idle speed	1250 ^{±50} min ⁻¹ , Engine at regular operating temperature

CLUTCH

Clutch type	Multi-plate oil-bath (anti-hopping)
-------------	-------------------------------------

TRANSMISSION

Type of transmission	Claw-shifted 6-speed manual gearbox integrated in the engine housing
Gearbox transmission ratios	1.821, Primary transmission ratio 1:2.833, 1st gear 1:2.067, 2nd gear 1:1.600, 3rd gear 1:1.308, 4th gear 1:1.103, 5th gear 1:0.968, 6th gear

FINAL DRIVE

Type of final drive	Chain drive
Chain deflection	35...45 mm, Motorcycle with no weight applied, supported on its side stand
–with low-slung ^{OE}	30...40 mm, Motorcycle with no weight applied, supported on its side stand
Permissible chain length	max 144 mm, measured from the centre of 10 rivets, chain pulled taut
Final drive, number of teeth (Pinion / sprocket)	17/44
Secondary transmission ratio	2.588

226 TECHNICAL DATA

FRAME

Frame type	Monocoque bridge-type steel frame
Type plate location	Frame, front left at steering head
Position of the vehicle identification number	Frame, front right

CHASSIS AND SUSPENSION

Front wheel

Type of front suspension	Upside-down telescopic fork
Spring travel, front	135 mm, at front wheel
–with low-slung ^{OE}	115 mm, at front wheel

Rear wheel

Type of rear suspension	Cast aluminium double swinging arm
Type of rear-wheel suspension	Central spring strut with coil spring, adjustable rebound stage damping and spring pre-load
Spring travel at rear wheel	142 mm, at rear wheel
–with low-slung ^{OE}	122 mm, at rear wheel

BRAKES

Front wheel

Type of front brake	Hydraulically operated twin disc brake with 4-piston radial brake calipers and floating brake discs
Brake-pad material, front	Sintered metal
Brake disc thickness, front	4.5 mm, When new min 4.0 mm, Wear limit
Play of brake controls (Front brake)	0.7...1.7 mm, measured at piston

Rear wheel

Type of rear brake	Hydraulically actuated disc brake with 1-piston floating caliper and fixed disc
Brake-pad material, rear	Organic material
Brake disc thickness, rear	5.0 mm, When new min 4.5 mm, Wear limit
Blow-by clearance of the foot-brake lever	2.0...3.0 mm, At right angles to direction of travel, between brake-light switch actuator and footrest plate

WHEELS AND TYRES

Recommended tyre combinations	An overview of currently approved tyres is available from your authorised BMW Motorrad retailer or on the Internet at bmw-motorrad.com .
Speed category, front/rear tyres	W, required at least: 270 km/h

228 TECHNICAL DATA

Front wheel

Front-wheel type	Aluminium cast wheel
Front-wheel rim size	3.50" x 17"
Tyre designation, front	120/70 ZR 17
Load index, front tyre	58
Permissible front-wheel imbalance	max 5 g

Rear wheel

Rear-wheel type	Aluminium cast wheel
Rear wheel rim size	5.50" x 17"
Tyre designation, rear	180/55 ZR 17
Load index, rear tyre	73
Permissible rear-wheel imbalance	max 45 g

Tyre pressure

Tyre pressure, front	2.5 bar, tyre cold
Tyre pressure, rear	2.9 bar, tyre cold

ELECTRICAL SYSTEM

Main fuse	40 A, Voltage regulator
Fuse box	10 A, Slot 1: instrument cluster, alarm system (DWA), ignition lock, diagnostic socket, coil main relay 7.5 A, Slot 2: multifunction switch left, tyre pressure control (RDC)
Electrical rating of on-board sockets	5 A

Battery

Battery type	AGM battery (Absorbent Glass Mat)
Battery rated voltage	12 V
Battery rated capacity	12 Ah
Battery type (For Keyless Ride radio-operated key)	
–with Keyless Ride ^{OE}	CR 2032

Spark plugs

Spark plugs, manufacturer and designation	NGK LMAR9J-9E
---	---------------

Lighting

Bulb for high-beam headlight	LED
Bulbs for the low-beam headlight	LED
Bulb for parking light	LED
Bulb for tail light/brake light	LED
Light source for the number plate light	Integrated in rear light
Bulbs for turn indicators	LED

ANTI-THEFT ALARM

Activation time on arming	approx. 30 s
Alarm duration	approx. 26 s
Battery type	CR 123 A

230 TECHNICAL DATA

DIMENSIONS

Length of motorcycle	2140 mm, over rear wheel
–with low-slung ^{OE}	2135 mm, over rear wheel
Height of motorcycle	1130 mm, via instrument cluster, at DIN unladen weight
–with low-slung ^{OE}	1110 mm, via instrument cluster, at DIN unladen weight
Width of motorcycle	815 mm, using the hand lever
Height of rider's seat	815 mm, without rider, at DIN unladen weight
–with seat, low ^{OE}	790 mm, without rider, at DIN unladen weight
–with seat, extra high ^{OE}	865 mm, without rider, at DIN unladen weight
–with low-slung ^{OE}	770 mm, without rider, at DIN unladen weight
Rider's inside-leg arc, heel to heel	1820 mm, without rider, at DIN unladen weight
–with seat, low ^{OE}	1785 mm, without rider, at DIN unladen weight
–with seat, extra high ^{OE}	1890 mm, without rider, at DIN unladen weight
–with low-slung ^{OE}	1755 mm, without rider, at DIN unladen weight

WEIGHTS

Vehicle kerb weight	211 kg, DIN unladen weight, ready for road, 90 % load of fuel, without optional equipment
Wheel load, front, at unladen weight	106 kg
Permissible wheel load, front	max 180 kg

Wheel load, rear, at unladen weight	105 kg
Permissible wheel load, rear	max 300 kg
Permissible gross vehicle weight	430 kg
Maximum payload	219 kg

PERFORMANCE FIGURES

Top speed	>200 km/h
-with case ^{OA}	180 km/h
-with topcase ^{OA}	180 km/h

SERVICE

13

REPORTING SAFETY-RELEVANT DEFECTS	234
BMW MOTORRAD SERVICE	235
BMW MOTORRAD SERVICE HISTORY	235
BMW MOTORRAD MOBILITY SERVICES	236
MAINTENANCE WORK	236
MAINTENANCE SCHEDULE	238
MAINTENANCE CONFIRMATIONS	239
SERVICE CONFIRMATIONS	251

REPORTING SAFETY-RELEVANT DEFECTS

–with Canada export^{NV}

If you think that your motorcycle has a fault which may cause an accident, injury or death, you must inform the NHTSA (National Highway Traffic Safety Administration) immediately and BMW of North America, LLC.

If the NHTSA receives other similar complaints, it may open an investigation. If it finds that a safety defect exists in a group of vehicles, the NHTSA may order the manufacturer to perform a recall and remedy campaign. However, the NHTSA cannot become involved in individual problems between you, your retailer, or BMW of North America, LLC.

You can contact the NHTSA by calling the Vehicle Safety hotline on 1-888-327-4236 (teletypewriter TTY for the hearing impaired: 1-800-424-9153) for free, by visiting the website at [http:// www.safercar.gov](http://www.safercar.gov) or by writing to Administrator, NHTSA, 400 Seventh Street, SW., Washington, DC 20590. Further information on vehicle safety is available at [http:// www.safercar.gov](http://www.safercar.gov).

Canadian customers who wish to report a safety-related defect to Transport Canada, Defect Investigations and Recalls can call the toll-free hotline 1-800-333-0510. You can also obtain other information about motor vehicle safety from [http:// www.tc.gc.ca/roadsafety](http://www.tc.gc.ca/roadsafety).

BMW MOTORRAD SERVICE

BMW Motorrad has an extensive network of retailers in place to look after you and your motorcycle in more than 100 countries. Authorised BMW Motorrad retailers have the technical information and the technical know-how to carry out reliably all preventive maintenance and repair work on your BMW.

You can locate the nearest authorised BMW Motorrad retailer by visiting our website: bmw-motorrad.com.



WARNING

Maintenance and repair work not in compliance with correct procedure

Risk of accident due to consequential damage

- BMW Motorrad recommends having work of this nature carried out on the vehicle by a specialist workshop, preferably an authorised BMW Motorrad dealer.

In order to help ensure that your BMW is always in optimum condition, BMW Motorrad recommends compliance with the maintenance intervals specified for your motorcycle.

Have all maintenance and repair work carried out confirmed in the "Service" chapter in this manual. Evidence of regular preventive maintenance is essential for generous treatment of claims submitted after the warranty period has expired.

Your authorised BMW Motorrad retailer can provide information on BMW Motorrad services and the work undertaken as part of each service.

BMW MOTORRAD SERVICE HISTORY

Entries

Maintenance work that has been carried out is entered in the proof of maintenance. The entries are like a Service Booklet and provide proof of regular maintenance.

When an entry is made in the electronic service booklet of the vehicle, service-relevant data is saved in the central IT

236 SERVICE

systems of BMW AG, Munich, Germany.

If there is a change in vehicle ownership, the data saved in the electronic service booklet can also be viewed by the new vehicle owner. A BMW Motorrad retailer or a specialist workshop can also view data that is stored in the electronic service booklet.

Objection

The vehicle owner can object to entries being made by the BMW Motorrad retailer or a specialist workshop in the electronic service booklet along with the corresponding storage of data in the vehicle and transfer of data to the vehicle manufacturer for the period of time that they are the vehicle owner. In this instance, no entry is made in the electronic service booklet of the vehicle.

BMW MOTORRAD MOBILITY SERVICES

As owner of a new BMW vehicle, in circumstances in which assistance is required you can benefit from the protection afforded by the various BMW Motorrad mobility services (e.g. Mobile

Service, breakdown service, vehicle recovery service). Ask your authorised BMW Motorrad retailer for information about the mobility services offered.

MAINTENANCE WORK

BMW pre-delivery check

Your authorised BMW Motorrad retailer conducts the BMW pre-delivery check before handing over the vehicle to you.

BMW Running-in Check

The BMW running-in check has to be performed when the motorcycle has covered between 500 km and 1200 km.

BMW Motorrad Service

The BMW Motorrad Service is carried out once a year; the extent of servicing can vary, depending on the age of the vehicle and the distance it has covered. Your authorised BMW Motorrad retailer confirms that the service work has been carried out and enters the date when the next service will be due.

Riders who cover long distances in a year might have to bring in their vehicles for service before the next sched-

uled date. It is to allow for these cases that a maximum odometer reading is entered as well in the confirmation of service. Servicing has to be brought forward if this odometer reading is reached before the next scheduled date for the service.

The service-due indicator in the display reminds you about one month or 1000 km in advance when the time for a service is approaching, on the basis of the programmed values.

To find out more about service go to:

bmw-motorrad.com/service

The maintenance tasks necessary for your vehicle are set out in the maintenance schedule below:

238 SERVICE

MAINTENANCE SCHEDULE

	50 000 -1200 km 300 - 750 mls	10 000 km 6 000 mls	20 000 km 12 000 mls	30 000 km 18 000 mls	40 000 km 24 000 mls	50 000 km 30 000 mls	60 000 km 36 000 mls	70 000 km 42 000 mls	80 000 km 48 000 mls	90 000 km 54 000 mls	100 000 km 60 000 mls	12 months	24 months
①	X												
②												X	
③		X	X	X	X	X	X	X	X	X	X	X ^a	
④			X		X		X		X		X		
⑤			X		X		X		X		X		
⑥			X		X		X		X		X		
⑦				X			X			X			
⑧												X ^b	X ^b

- 1 BMW Running-in check
- 2 BMW Motorrad Service, standard scope
- 3 Engine-oil change, with filter
- 4 Check valve clearances
- 5 Replace all spark plugs
- 6 Replace air-filter element
- 7 Oil change in the telescopic forks
- 8 Change brake fluid, entire system

^a annually or every 10,000 km (whichever comes first)

^b for the first time after one year, then every two years

MAINTENANCE CONFIRMATIONS

BMW Motorrad Service standard scope

The tasks included in the BMW_Motorrad Service standard scope are listed below. The actual scope of maintenance work applicable for your vehicle may vary.

- Performing vehicle test with BMW Motorrad diagnosis system
- Checking coolant level
- Checking/adjusting clutch play
- Checking front brake pads and brake discs for wear
- Checking rear brake pads and brake disc for wear
- Checking brake fluid level, front and rear
- Visual inspection of the brake lines, brake hoses and connections
- Checking tyre pressure and tread depth
- Checking and lubricating the chain drive
- Check the side stand's ease of movement
- Checking ease of movement of the centre stand
- Checking steering-head bearing
- Check lighting and signalling system
- Function test, engine start suppression
- Final inspection and check for road safety
- Setting service-due date and countdown distance with BMW Motorrad diagnosis system
- Checking battery state of charge
- Confirming BMW Motorrad service in on-board literature

240 SERVICE

BMW pre-delivery check
carried out

on _____

Stamp, signature

BMW Running-in Check
carried out

on _____

odometer reading _____

Next service

at the latest

on _____

or, when reached earlier

odometer reading _____

Stamp, signature

BMW Motorrad service

carried out

on _____

odometer reading _____

Next service

at the latest

on _____

or, when reached earlier

odometer reading _____

Work performed

	Yes	No
BMW Motorrad service	<input type="checkbox"/>	<input type="checkbox"/>
Oil change, engine, with filter	<input type="checkbox"/>	<input type="checkbox"/>
Checking valve clearance	<input type="checkbox"/>	<input type="checkbox"/>
Renewing all spark plugs	<input type="checkbox"/>	<input type="checkbox"/>
Renewing air cleaner insert	<input type="checkbox"/>	<input type="checkbox"/>
Oil change in telescopic front forks	<input type="checkbox"/>	<input type="checkbox"/>
Change brake fluid in entire system	<input type="checkbox"/>	<input type="checkbox"/>

Notes

Stamp, signature

242 SERVICE

BMW Motorrad service

carried out

on _____

odometer reading _____

Next service

at the latest

on _____

or, when reached earlier

odometer reading _____

Work performed

	Yes	No
BMW Motorrad service	<input type="checkbox"/>	<input type="checkbox"/>
Oil change, engine, with filter	<input type="checkbox"/>	<input type="checkbox"/>
Checking valve clearance	<input type="checkbox"/>	<input type="checkbox"/>
Renewing all spark plugs	<input type="checkbox"/>	<input type="checkbox"/>
Renewing air cleaner insert	<input type="checkbox"/>	<input type="checkbox"/>
Oil change in telescopic front forks	<input type="checkbox"/>	<input type="checkbox"/>
Change brake fluid in entire system	<input type="checkbox"/>	<input type="checkbox"/>

Notes

Stamp, signature

BMW Motorrad service

carried out

on _____

odometer reading _____

Next service

at the latest

on _____

or, when reached earlier

odometer reading _____

Work performed

	Yes	No
BMW Motorrad service	<input type="checkbox"/>	<input type="checkbox"/>
Oil change, engine, with filter	<input type="checkbox"/>	<input type="checkbox"/>
Checking valve clearance	<input type="checkbox"/>	<input type="checkbox"/>
Renewing all spark plugs	<input type="checkbox"/>	<input type="checkbox"/>
Renewing air cleaner insert	<input type="checkbox"/>	<input type="checkbox"/>
Oil change in telescopic front forks	<input type="checkbox"/>	<input type="checkbox"/>
Change brake fluid in entire system	<input type="checkbox"/>	<input type="checkbox"/>

Notes

Stamp, signature

244 SERVICE

BMW Motorrad service

carried out

on_____

odometer reading_____

Next service

at the latest

on_____

or, when reached earlier

odometer reading_____

Work performed

	Yes	No
BMW Motorrad service	<input type="checkbox"/>	<input type="checkbox"/>
Oil change, engine, with filter	<input type="checkbox"/>	<input type="checkbox"/>
Checking valve clearance	<input type="checkbox"/>	<input type="checkbox"/>
Renewing all spark plugs	<input type="checkbox"/>	<input type="checkbox"/>
Renewing air cleaner insert	<input type="checkbox"/>	<input type="checkbox"/>
Oil change in telescopic front forks	<input type="checkbox"/>	<input type="checkbox"/>
Change brake fluid in entire system	<input type="checkbox"/>	<input type="checkbox"/>

Notes

Stamp, signature

BMW Motorrad service

carried out

on _____

odometer reading _____

Next service

at the latest

on _____

or, when reached earlier

odometer reading _____

Work performed

	Yes	No
BMW Motorrad service	<input type="checkbox"/>	<input type="checkbox"/>
Oil change, engine, with filter	<input type="checkbox"/>	<input type="checkbox"/>
Checking valve clearance	<input type="checkbox"/>	<input type="checkbox"/>
Renewing all spark plugs	<input type="checkbox"/>	<input type="checkbox"/>
Renewing air cleaner insert	<input type="checkbox"/>	<input type="checkbox"/>
Oil change in telescopic front forks	<input type="checkbox"/>	<input type="checkbox"/>
Change brake fluid in entire system	<input type="checkbox"/>	<input type="checkbox"/>

Notes

Stamp, signature

246 SERVICE

BMW Motorrad service

carried out

on _____

odometer reading _____

Next service

at the latest

on _____

or, when reached earlier

odometer reading _____

Work performed

	Yes	No
BMW Motorrad service	<input type="checkbox"/>	<input type="checkbox"/>
Oil change, engine, with filter	<input type="checkbox"/>	<input type="checkbox"/>
Checking valve clearance	<input type="checkbox"/>	<input type="checkbox"/>
Renewing all spark plugs	<input type="checkbox"/>	<input type="checkbox"/>
Renewing air cleaner insert	<input type="checkbox"/>	<input type="checkbox"/>
Oil change in telescopic front forks	<input type="checkbox"/>	<input type="checkbox"/>
Change brake fluid in entire system	<input type="checkbox"/>	<input type="checkbox"/>

Notes

Stamp, signature

BMW Motorrad service

carried out

on_____

odometer reading_____

Next service

at the latest

on_____

or, when reached earlier

odometer reading_____

Work performed

	Yes	No
BMW Motorrad service	<input type="checkbox"/>	<input type="checkbox"/>
Oil change, engine, with filter	<input type="checkbox"/>	<input type="checkbox"/>
Checking valve clearance	<input type="checkbox"/>	<input type="checkbox"/>
Renewing all spark plugs	<input type="checkbox"/>	<input type="checkbox"/>
Renewing air cleaner insert	<input type="checkbox"/>	<input type="checkbox"/>
Oil change in telescopic front forks	<input type="checkbox"/>	<input type="checkbox"/>
Change brake fluid in entire system	<input type="checkbox"/>	<input type="checkbox"/>

Notes

Stamp, signature

248 SERVICE

BMW Motorrad service

carried out

on_____

odometer reading_____

Next service

at the latest

on_____

or, when reached earlier

odometer reading_____

Work performed

	Yes	No
BMW Motorrad service	<input type="checkbox"/>	<input type="checkbox"/>
Oil change, engine, with filter	<input type="checkbox"/>	<input type="checkbox"/>
Checking valve clearance	<input type="checkbox"/>	<input type="checkbox"/>
Renewing all spark plugs	<input type="checkbox"/>	<input type="checkbox"/>
Renewing air cleaner insert	<input type="checkbox"/>	<input type="checkbox"/>
Oil change in telescopic front forks	<input type="checkbox"/>	<input type="checkbox"/>
Change brake fluid in entire system	<input type="checkbox"/>	<input type="checkbox"/>

Notes

Stamp, signature

BMW Motorrad service

carried out

on _____

odometer reading _____

Next service

at the latest

on _____

or, when reached earlier

odometer reading _____

Work performed

	Yes	No
BMW Motorrad service	<input type="checkbox"/>	<input type="checkbox"/>
Oil change, engine, with filter	<input type="checkbox"/>	<input type="checkbox"/>
Checking valve clearance	<input type="checkbox"/>	<input type="checkbox"/>
Renewing all spark plugs	<input type="checkbox"/>	<input type="checkbox"/>
Renewing air cleaner insert	<input type="checkbox"/>	<input type="checkbox"/>
Oil change in telescopic front forks	<input type="checkbox"/>	<input type="checkbox"/>
Change brake fluid in entire system	<input type="checkbox"/>	<input type="checkbox"/>

Notes

Stamp, signature

250 SERVICE

BMW Motorrad service

carried out

on_____

odometer reading_____

Next service

at the latest

on_____

or, when reached earlier

odometer reading_____

Work performed

	Yes	No
BMW Motorrad service	<input type="checkbox"/>	<input type="checkbox"/>
Oil change, engine, with filter	<input type="checkbox"/>	<input type="checkbox"/>
Checking valve clearance	<input type="checkbox"/>	<input type="checkbox"/>
Renewing all spark plugs	<input type="checkbox"/>	<input type="checkbox"/>
Renewing air cleaner insert	<input type="checkbox"/>	<input type="checkbox"/>
Oil change in telescopic front forks	<input type="checkbox"/>	<input type="checkbox"/>
Change brake fluid in entire system	<input type="checkbox"/>	<input type="checkbox"/>

Notes

Stamp, signature

DECLARATION OF CONFORMITY	255
CERTIFICATE FOR ELECTRONIC IMMOBILISER	260
CERTIFICATE FOR KEYLESS RIDE	263
CERTIFICATE FOR TYRE PRESSURE CONTROL (RDC)	267
CERTIFICATE FOR TFT INSTRUMENT CLUSTER	268

DECLARATION OF CONFORMITY

Simplified EU Declaration of Conformity under RED (2014/53/EU).



Vehicular immobilizer system transceiver EWS4

Technical information

Frequency band: 134 kHz
 Transponder: TMS37145 / TypeDST80, TMS3705 Transponder Base Station IC
 Output Power: 50 dB μ V/m

Manufacturer

BECOM Electronics GmbH
 Technikerstraße 1, A-7442
 Hochstraß, Austria

Hereby, BECOM Electronics GmbH declares that the vehicular immobilizer system transceiver EWS4 is in compliance with Directive 2014/53/EU. The full text of the EU declaration of conformity is available at the following internet ad-

dress:

bmw-motorrad.com/certification

Keyless Ride HUF5750

Technical information

Frequency band: 434,42 MHz
 Transmission Power: 10 mW

Manufacturer

Huf Hüsbeck & Fürst GmbH & Co. KG
 Steeger Str. 17, 42551 Velbert, Germany

Hereby, Huf Hüsbeck & Fürst GmbH & Co. KG declares that the radio equipment type HUF5750 is in compliance with Directive 2014/53/EU. The full text of the EU declaration of conformity is available at the following internet address: **bmw-motorrad.com/certification**

Keyless Ride HUF8465

Technical information

Frequency band: 134,45 kHz
 Output Power: 42 dB μ V/m

Manufacturer

Huf Hüsbeck & Fürst GmbH & Co. KG
 Steeger Str. 17, 42551 Velbert, Germany

256 APPENDIX

Hereby, Huf Hüsbeck & Fürst GmbH & Co. KG declares that the radio equipment type HUF8465 is in compliance with Directive 2014/53/EU. The full text of the EU declaration of conformity is available at the following internet address:

bmw-motorrad.com/certification

Anti-theft alarm (DWA)

TXBMWMR

Technical information

Frequency band: 433.05 MHz - 434.79 MHz

Output power: 10 mW e.r.p.

Manufacturer

Meta System S.p.A.
Via Galimberti 5, 42124 Reggio Emilia, Italy

Hereby, Meta System S.p.A. declares that the radio equipment type TXBMWMR is in compliance with Directive 2014/53/EU. The full text of the EU declaration of conformity is available at the following internet address:

bmw-motorrad.com/certification

Tyre pressure control (RDC) BC5A4

Technical information

Frequency band: 433.895 - 433.945 MHz

Output Power: <10 mW e.r.p.

Manufacturer

Schrader Electronics Ltd.
Technology Park, N. Ireland
BT41 1QS Antrim, United Kingdom

Hereby, Schrader Electronics Ltd. declares that the radio equipment type BC5A4 is in compliance with Directive 2014/53/EU. The full text of the EU declaration of conformity is available at the following internet address:

bmw-motorrad.com/certification

Wireless charging device

WCA Motorrad-Ladestauaufach

Technical information

Frequency band: 110 kHz - 115 kHz

Output power: < 6 W

Manufacturer

Bury Sp. z o.o.
ul. Wojska Polskiego 4, 39-300 Mielec, Poland

Hereby, Bury Sp. z o.o. declares that the radio equipment type WCA Motorrad-Ladestafach is in compliance with Directive 2014/53/EU. The full text of the EU declaration of conformity is available at the following internet address:

bmw-motorrad.com/certification

TFT instrument cluster ICC6.5in

Technical information

BT operating frq. Range:
2402 MHz - 2480 MHz
BT version: 4.2 (no BTLE)
BT output power: < 4 dBm
WLAN operating frq. Range:
2412 MHz - 2462 MHz
WLAN standards: IEEE 802.11
b/g/n
WLAN output power: <
20 dBm

Manufacturer

Robert Bosch Car Multimedia
GmbH
Robert Bosch Str. 200, 31139
Hildesheim, Germany

Hereby, Robert Bosch Car Multimedia GmbH declares that the radio equipment type ICC6.5in is in compliance with Directive 2014/53/EU. The full text of the EU declaration of conformity is available at the

following internet address:
bmw-motorrad.com/certification

TFT instrument cluster ICC10in

Technical information

The ICC10in can operate in one of two operating modes:

1. Normal mode, with Bluetooth and WLAN on, and
2. Radio off mode (only available during vehicle manufacturing).

BT operating frq. Range:
2402 MHz - 2480 MHz
BT version: 4.2 (no BTLE)
BT output power: < +4 dBm
(internal antenna)
WLAN operating frq. Range:
2402 MHz - 2472 MHz
WLAN standards: IEEE 802.11
b/g/n
WLAN output power:
< +14 dBm (internal antenna)

Manufacturer

Robert Bosch GmbH
Robert-Bosch-Platz 1, 70839
Gerlingen, Germany

Hereby, Robert Bosch GmbH declares that the radio equipment type ICC10in is in compliance with Directive 2014/53/EU. The full text of the EU declaration of conformity is available at the following internet address:

258 APPENDIX

bmw-motorrad.com/certification

Intelligent emergency call TPM E-CALL EU

Technical information

Antenna internal:

Frequency band: 880 MHz -
915 MHz

Radiated Power [TRP]: <
22 dBm

Not accessible by user:

Frequency band: 1710 MHz -
1785 MHz

Radiated Power [TRP]: <
26 dBm

Frequency band: 1920 MHz -
1980 MHz

Radiated Power [TRP]: <
22 dBm

Frequency band: 880 MHz -
915 MHz

Radiated Power [TRP]: <
23 dBm

Manufacturer

Robert Bosch Car Multimedia
GmbH

Robert Bosch Str. 200, 31139
Hildesheim, Germany

Hereby, Robert Bosch Car Multimedia GmbH declares that the radio equipment type TPM E-CALL EU is in compliance with Directive 2014/53/EU. The full text of the EU declaration of conformity is available at the following internet ad-

dress:

bmw-motorrad.com/certification

Mid Range Radar MRRe14FCR

Technical information

Frequency band: 76 - 77 GHz
Nominal radiated power: e.i.r.p.
(peak detector): 32 dBm
Nominal radiated power:e.i.r.p.
(RMS detector): 27 dBm

Manufacturer

Robert Bosch GmbH
Robert-Bosch-Platz 1, 70839
Gerlingen, Germany

Hereby, Robert Bosch GmbH declares that the radio equipment type MRRe14FCR is in compliance with Directive 2014/53/EU. The full text of the EU declaration of conformity is available at the following internet address:

bmw-motorrad.com/certification

Audio system MCR001 Manufacturer

ALPS ALPINE CO., LTD.

Hereby, ALPS ALPINE CO., LTD. declares that the radio equipment type MCR001 is in compliance with Directive 2014/53/EU. The full text of the EU declaration of conformity is available at the following in-

ternet address:

**bmw-motorrad.com/certifica-
tion**

Declaration of Conformity

Radio equipment electronic immobiliser (EWS4)

For all countries without EU

Technical information

Frequency Band: 134 kHz
(Transponder: TMS37145 /
Type DST80, TMS3705
Transponder Base Station IC)
Output Power: 50 dB μ V/m

Manufacturer and Address

Manufacturer:
BECOM Electronics GmbH
Address: Technikerstraße 1,
A-7442 Hochstraß

Argentina

 **RAMATEL**

H-25246

Australia/New Zealand



R-NZ

Brunei



TA No: DTA-007061

United Arab Emirates

TRA
REGISTERED No:
ER89926/20

DEALER No:
DA96133I20

Philippiens



NTC

Type Approved

No.: ESD-RCE-2023298

South Africa



TA-2020/6131

APPROVED

India

ETA-SD-20200905860

Belarus



Indonesia

72790/SDPPI/2021

13349



Dilarang melakukan perubahan Spesifikasi yang dapat Menimbulkan gangguan fisik dan/atau elektromagnetik terhadap lingkungan sekitarnya

Paraguay

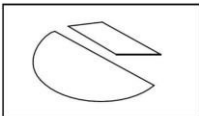

CONATEL

NR: 2020-11-I-0834

Singapore

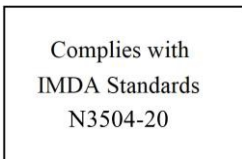

Taiwan



低功 電波 射性電機管 辦法
第十二條 經型式認證合格之低
功率射頻電 機，非經許可，公
司、商號或使用者均不得擅自
變更頻率、加大功率或變更原
設計之特性及 功能。第十四條
低功率射頻電機之使用不得影
響飛航安全及干擾合法通信；
經發現有干 擾現象時，應立即
停用，並改善至無干擾時方得
繼續使用。前項合法通信，指
依電信法規定作業之無線電通
信。

Malaysia



RFCL/47A/0920/S(20-3358)

Israel

ספר אישור אלחוטי של משרד התקשורת הוא
51-7490
סמל להחליף את האנטנה המקורית של המכשיר
לא
עשות בו כל שינוי טכני אחר

United States (USA)

Contains FCC ID:

ODE-MREWS5012

FCC § 15.19 Labelling requirements

This device complies with part 15 of the FCC Rules and Industry Canada's licence-exempt RSS standard(s). Operation is subject to the following two conditions:

- (1) this device may not cause interference, and
- (2) this device must accept any interference received, including interference that may cause undesired operation.

FCC § 15.21 Information to user

Changes or modifications not expressly approved by the party responsible for compliance could void the user's authority to operate the equipment.

RF Exposure Requirements

To comply with FCC RF exposure compliance requirements, the device must be installed to provide a separation distance of at least 20 cm from all persons.

Serbia



P1620118300

Canada

Contains IC:

10430A-MREWS5012

This device complies with part 15 of the FCC Rules and Industry Canada license-exempt RSS standard(s). Operation is subject to the following two conditions:

- (1) this device may not cause interference, and
- (2) this device must accept any interference received, including interference that may cause undesired operation.

Le présent appareil est conforme aux CNR d'Industrie Canada applicables aux appareils radio exempts de licence. L'exploitation est autorisée aux deux conditions suivantes : (1) l'appareil ne doit pas produire de brouillage, et (2) l'utilisateur de l'appareil doit accepter tout brouillage radioélectrique subi, même si le brouillage est susceptible d'en compromettre le fonctionnement.

Vietnam



A1109091120AF04A3

Certifications

BMW Keyless Ride ID Device



USA, Canada:

Product name: BMW Keyless Ride ID
Device FCC ID: YGOHUF5750
IC: 4008C-HUF5750



Any changes or modifications not expressly approved by the party responsible for compliance could void the user's authority to operate the equipment.

Canada:

Operation is subject to the following two conditions:

- (1) This device may not cause harmful interference, and
- (2) this device must accept any interference received, including interference that may cause undesired operation.

USA:

This device complies with Part 15 of the FCC rules. Operation is subject to the following two conditions:

- (1) This device may not cause harmful interference, and
- (2) this device must accept any interference received, including interference that may cause undesired operation.

Argentina:

CNC COMISIÓN NACIONAL
DE COMUNICACIONES

H-17115

Declaration Of Conformity

We declare under our responsibility that the product

BMW Keyless Ride ID Device (Model: HUF5750)

complies with the appropriate essential requirements of the article 3 of the R&TIE and the other relevant provisions, when used for its intended purpose. Applied Standards:

1. Health and safety requirements contained in article 3 (1) a)
 - EN 60950-1:2006+A11:2009+A1:2010+A12:2011; Information technology equipment-Safety
2. Protection requirements with respect to electromagnetic compatibility article 3 (1) b)
 - EN 301 489-1 (V1 .9.2, 09/2011), Electromagnetic compatibility and radio spectrum matters (ERM); Electromagnetic compatibility (EMC) standard for radio equipment and services; Part 1: Common technical requirements
 - EN 301 489-3 (V1.4.1, 08/2002) Electromagnetic compatibility and radio spectrum matters (ERM); Electromagnetic compatibility (EMC) standard for radio equipment and services; Part 3: Specific conditions for short range devices (SRD) operating on frequencies between 9 kHz and 40 GHz
3. Means of the efficient use of the radio frequency spectrum article 3 (2)
 - EN 300 220-1 & -2 (V2.4.1, 05/2012), electromagnetic compatibility and radio spectrum matters (ERM); Short range devices (SRD); Radio equipment to be used in the 25 MHz to 1000 MHz frequency range with power levels ranging up to 500 mW; Part 1: Technical characteristics and test methods. Part 2: Harmonized EN covering essential requirements under article 3.2 of the R&TIE directive

The product is labeled with the CE marking:

CE

Velbert, October 15th, 2013

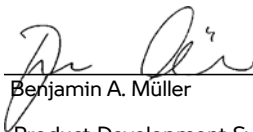

Benjamin A. Müller

Product Development Systems
Car Access and Immobilization -
Electronics Huf Hülsbeck & Fürst
GmbH & Co. KG
Steeger Straße 17, D-42551
Velbert

Certification Tire Pressure Control (TPC)

FCC ID: MRXBC54MA4
IC: 2546A-BC54MA4

FCC ID: MRXBC5A4
IC: 2546A-BC5A4

This device complies with Part 15 of the FCC Rules and with Industry Canada license-exempt RSS standard(s).

Operation is subject to the following two conditions:

- (1) This device may not cause harmful interference, and
- (2) This device must accept any interference received, including interference that may cause undesired operation.

WARNING: Changes or modifications not expressly approved by the party responsible for compliance could void the user's authority to operate the equipment. The term "IC:" before the radio certification number only signifies that Industry Canada technical specifications were met.

Le présent appareil est conforme aux CNR d'Industrie Canada applicables aux appareils radio exempts de licence. L'exploitation est autorisée aux deux conditions suivantes:

- (1) l'appareil ne doit pas produire de brouillage, et
- (2) l'utilisateur de l'appareil doit accepter tout brouillage radioélectrique subi, même si le brouillage est susceptible d'en compromettre le fonctionnement.

WARNING: Changes or modifications not expressly approved by the party responsible for compliance could void the user's authority to operate the equipment. The term "IC:" before the radio certification number only signifies that Industry Canada technical specifications were met.

Declaration of Conformity

Radio equipment TFT instrument cluster

For all Countries without EU

Technical information

BT operating frq. Range:
2402 – 2480 MHz
BT version: 4.2 (no BTLE)
BT output power: < 4 dBm
WLAN operating frq. Range:
2412 – 2462 MHz
WLAN standards:
IEEE 802.11 b/g/n
WLAN output power: < 20 dBm

Manufacturer and Address

Manufacturer:
Robert Bosch Car Multimedia
GmbH
Address: Robert Bosch Str. 200,
31139 Hildesheim, Germany

Turkey

Robert Bosch Car Multimedia
GmbH, ICC6.5in tipi telsiz
sistemini 2014/53/EU
nolu yönetmeliğe uygun olduğunu
beyan eder. AB Uygunluk
Beyanı'nın tam metni, aşağıdaki
internet adresinden görülebilir:
<http://cert.bosch-carmultimedia.net>

Argentina

 **RAMATEL**

C-24711

Brazil

Este equipamento opera em caráter secundário, isto é, não tem direito a proteção contra interferência prejudicial, mesmo de estações do mesmo tipo, e não pode causar interferência a sistemas operando em caráter primário.

Canada

This device complies with Industry Canada's licence-exempt RSSs and part 15 of the FCC Rules. Operation is subject to the following two conditions:

- (1) this device may not cause interference, and
- (2) this device must accept any interference, including interference that may cause undesired operation of the device.

Changes or modifications not expressly approved by the party responsible for compliance could void the user's authority to operate the equipment.

Le présent appareil est conforme aux CNR d'Industrie Canada applicables aux appareils radio exempts de licence. L'exploitation est autorisée aux deux conditions suivantes : (1) l'appareil ne doit pas produire de brouillage, et (2) l'appareil doit accepter tout brouillage radioélectrique subi, même si le brouillage est susceptible d'en compromettre le fonctionnement.

Korea

적합성평가에 관한 고시
R-CMM-RBR-ICC65IN
상호 : Robert Bosch Car
Multimedia GmbH모델명 :
ICC6.5in
기자재명칭 : 특정소출력 무선기
기
(무선데이터통신시스템용 무선기
기)
제조사 및 제조국가 : Robert
Bosch Car Multimedia GmbH /
포르투갈
제조년월 : 제조년월로 표기
이 기기는 업무용 환경에서 사용
할 목적으로 적합성평가를 받은
기기로서 가정용 환경에
서 사용하는 경우 전파간섭의 우
려가 있습니
다.

Mexico

La operación de este equipo está sujeta a las siguientes dos condiciones:

- (1) es posible que este equipo o dispositivo no cause interferencia perjudicial y
- (2) este equipo o dispositivo debe aceptar cualquier interferencia, incluyendo la que pueda causar su operación no deseada.

Taiwan, Republic of

根據 NCC 低功率電波輻射性電機
管理辦法 規定: 第十二條
經型式認證合格之低功率射頻電
機, 非經許可, 公司、商號或使用
者均不得擅自變更頻率、加大功率
或變更原設計之特性及功能。
第十四條
低功率射頻電機之使用不得影響飛
航安全及干擾合法通信; 經發現有
干擾現象時, 應立即停用, 並改善
至無干擾時方得繼續使用。
前項合法通信,
指依電信法規定作業之無線電通
信。
低功率射頻電機須忍受合法通信或
工業、科學及醫療用電波輻射性電
機設備之干擾。

Thailand

เครื่องโทรคมนาคมและอุปกรณ์ นี้

มีความสอดคล้องตามข้อกำหนดของ กทช.

(This telecommunication equipments is in compliance with NTC requirements)

United States (USA)

This device complies with Industry Canada's licence-exempt RSSs and part 15 of the FCC Rules. Operation is subject to the following two conditions:

- (1) this device may not cause interference, and
- (2) this device must accept any interference, including interference that may cause undesired operation of the device.

Changes or modifications not expressly approved by the party responsible for compliance could void the user's authority to operate the equipment.

Le présent appareil est conforme aux CNR d'Industrie Canada applicables aux appareils radio exempts de licence. L'exploitation est autorisée aux deux conditions suivantes : (1) l'appareil ne doit pas produire de brouillage, et (2) l'appareil doit accepter tout brouillage radioélectrique subi, même si le brouillage est susceptible d'en compromettre le fonctionnement.

272 INDEX

- A**
- Abbreviations and symbols, 4
- ABS
 - Engineering details, 148
 - Self-diagnosis, 132
 - Status indicators, 52
- Accessories
 - General notes, 200
- Adaptive Headlight, 160
 - Engineering details, 160
- Ambient temperature
 - Display, 40
 - Outside temperature warning, 40
- Anti-theft alarm
 - Indicator light, 24
 - operating, 86
 - Warning light, 44
- ASC
 - Control, 21
 - Engineering details, 151
 - Indicator and warning light, 54
 - operating, 75
 - Self-diagnosis, 132
- B**
- Battery
 - charging battery when connected, 192
 - charging the battery when disconnected, 193
 - Indicator light for vehicle voltage, 41, 42
 - installing, 194
 - Maintenance instructions, 191
 - removing, 193
 - Technical data, 229
- Best-ever lap, 85
- Bluetooth, 104
 - Pairing, 104
- Brake fluid
 - Checking fluid level, front, 171
 - Checking fluid level, rear, 172
 - Reservoir, front, 19
 - Reservoir, rear, 19
- Brake pads
 - checking front, 169
 - checking rear, 170
 - Running in, 134
- Brakes
 - ABS Pro in detail, 150
 - ABS Pro depending on riding mode, 138
 - Adjusting brake lever, 120
 - Checking operation, 169
 - Safety information, 136
 - Technical data, 227
- C**
- Care
 - Chrome, 214
 - Paintwork preservation, 215
- Cases, 201
- Chain
 - Adjusting sag, 187
 - Checking sag, 187
 - Checking wear, 188
 - Lubricating, 186
- Chassis and suspension
 - Technical data, 226
- Check control
 - Dialogue, 33
 - Display, 33
- Clock
 - adjusting, 103

- Clutch
 - Adjusting clutch lever, 119
 - Adjusting play, 173
 - Checking operation, 173
 - Checking play, 173
 - Technical data, 225
- Coolant
 - Checking fill level, 174
 - Fill-level indicator, 19
 - Indicator light for overheating, 45
 - topping up, 174
- Cruise control
 - operating, 82
- Currency, 6
- D**
- Damping
 - Adjuster, 18
- Daytime riding lights
 - automatic daytime riding light, 73
 - manual daytime riding light, 72
- Diagnostic connector
 - disengaging, 197
 - Position on the vehicle, 20
 - securing, 197
- Dimensions
 - Technical data, 230
- DTC
 - Engineering details, 151
 - Indicator and warning light, 54
 - operating, 75
 - Self-diagnosis, 133
- DWA, 45
 - Technical data, 229
- Dynamic Brake Control, 157
 - Engineering details, 156
- Dynamic engine brake control, 153
- Dynamic ESA Control, 21
 - operating, 77
- E**
- Electrical system
 - Technical data, 228
- Emergency braking, 137
- Emergency call
 - Automatically in the event of a light fall, 70
 - Automatically in the event of a severe fall, 70
 - Language, 69
 - manual, 69
 - Notes, 11
 - operating, 68
- Emergency off switch (kill switch)
 - Control, 22, 23
 - operating, 68
- Engine, 46
 - Indicator light for engine control unit, 47
 - Indicator light for engine electronics, 46
 - starting, 130
 - Technical data, 223, 224
 - Warning light, drive malfunction, 45
- Engine oil
 - Checking fill level, 167
 - Filler neck, 18
 - Oil dipstick, 18
 - Technical data, 222

274 INDEX

topping up, 168
Equipment, 5

F

Final drive
 Technical data, 225
Frame
 Technical data, 226
Front-wheel stand
 installing, 165
Fuel
 Fuel grade, 139
 refuelling, 140
 refuelling with Keyless
 Ride, 141, 142
 Technical data, 221, 222

Fuel filler cap emergency
 release, 143, 144

Fuel reserve
 Range, 102
 Warning, 56

Fuses
 Position on the vehicle, 20
 replacing, 195

G

General views
 Indicator and warning
 lights, 28
 Instrument cluster, 24
 Left multifunction switch, 21
 left side of vehicle, 18
 Multifunction switch, right, 22,
 23
 My vehicle, 107
 right side of vehicle, 19
 TFT display, 29, 30
 Underneath the seat, 20

H

Hazard warning flashers
 Control, 21
 operating, 74
Headlight
 Adjusting headlight beam
 throw, 119
 Headlight beam throw, 118
Headlight courtesy delay
 feature, 71
Heated handlebar grips
 Control, 22, 23
 operating, 90
Horn, 21

I

Ignition
 switching off, 63
 switching on, 62
Immobiliser
 Spare key, 67
Indicator lights, 24
 Overview, 28
Instrument cluster
 Ambient-light brightness
 sensor, 24
 Overview, 24

J

Jump-starting, 190

K

Keyless Ride, 41
 Battery of the radio-operated
 key is empty or loss of the
 radio-operated key, 65
 Engaging steering lock, 64
 Fuel filler cap, unlocking, 141,
 142
 Switching off ignition, 65
 Switching on ignition, 64

- Warning, 40
- Warning light, 41
- Keys, 62, 63
- L**
- Laptimer, 84
 - adjusting, 85
 - Ending timing, 85
 - Starting timing, 84
- Lighting
 - Indicator light for faulty bulb, 43
 - Replacing LED light sources, 189
 - Technical data, 229
- Lights
 - Adaptive Headlight, 160
 - automatic daytime riding light, 73
 - Control, 21
 - Headlight courtesy delay feature, 71
 - Headlight flasher, operating, 71
 - High-beam headlight, operating, 71
 - Low-beam headlight, 71
 - manual daytime riding light, 72
 - Parking lights, operating, 72
 - Side light, 71
- Lowered suspension
 - Restrictions, 126
- Luggage
 - Instructions for loading, 127

- M**
- Maintenance
 - Maintenance schedule, 238
- Maintenance confirma-
tions, 239
- Maintenance intervals, 236
- Media
 - operating, 112
- Menu
 - calling up, 98
- Mirrors
 - adjusting, 118
- Mobility services, 236
- Motorcycle
 - care, 210
 - cleaning, 210
 - lashing, 144
 - laying up, 215
 - parking, 138
 - restoring to use, 215
- Multifunction switch
 - Overview, left side, 21
 - Overview, right side, 22, 23
- N**
- Navigation
 - operating, 110
- O**
- On-board computer, 110
- On-board voltage
 - Warning light, 41, 42
- Operating focus
 - change, 99
- P**
- Pairing, 104
- Parking, 138
- Parking light, 72
- Performance figures
 - Technical data, 231

276 INDEX

- Phone
 - operating, 113
- Power socket
 - Notes on use, 200
- Pre-Ride-Check, 131
- Pure Ride
 - Overview, 29
- R**
- RDC
 - Engineering details, 157
 - Warning indicators, 48, 51
- Rear-wheel stand
 - installing, 166
- Refuelling, 140
 - Fuel grade, 139
 - with Keyless Ride, 141, 142
- Remote control
 - Replacing battery, 66
- Rev. counter, 24
 - Rev. counter, 101
- Riding mode, 79
 - Setting up riding mode PRO, 81
- Riding-mode preselection, 79
 - configure, 79
- Running in, 134
- S**
- Safety instructions
 - for brakes, 136
 - for riding, 126
- Screw connections, 220
- Seat
 - installing, 90
 - Lock, 18
 - removing, 90
- Service, 235
 - Reporting safety-relevant defects, 234
 - Service history, 235
- Service-due indicator, 57
- Shift assistant
 - Engineering details, 159
 - Gear not taught, 56
 - Riding, 135
- Shift light, 86
 - adjusting, 86
 - switching on/off, 86
- Shifting gear
 - Recommendation to upshift, 102
 - Shift light, 136
- Spark plugs
 - Technical data, 229
- Speed Limit Info
 - Switching on or off, 101
- Speedometer, 24
- Spring preload, 78
 - Adjuster, 19
 - adjusting, 120
- Starting, 130
 - Control, 22, 23
- Status line, top
 - adjusting, 99, 100
- Steering lock
 - Locking, 62
- T**
- Technical data
 - Anti-theft alarm, 229
 - Battery, 229
 - Brakes, 227
 - Chassis and suspension, 226
 - Clutch, 225
 - Dimensions, 230
 - Electrical system, 228

- Engine, 223, 224
 - Engine oil, 222
 - Final drive, 225
 - Frame, 226
 - Fuel, 221, 222
 - General notes, 5
 - Lighting, 229
 - Performance figures, 231
 - Spark plugs, 229
 - Standards, 5
 - Transmission, 225
 - Weights, 230
 - Wheels and tyres, 227
 - TFT display, 24
 - Control, 21
 - operating, 98, 99
 - Overview, 29, 30
 - Selecting display, 95
 - Toolkit
 - Position on the vehicle, 20
 - Topcase
 - operating, 202
 - Torques, 220
 - Traction control
 - ASC, 151
 - DTC, 151
 - Transmission
 - Technical data, 225
 - Troubleshooting chart, 218
 - Turn indicators
 - Control, 21
 - operating, 74
 - Type plate
 - Position on the vehicle, 19
 - Tyre pressure monitoring RDC
 - Display, 47
 - Tyres
 - Checking tread depth, 175
 - Checking tyre pressure, 175
 - Pressures, 228
 - Recommendation, 176
 - Running in, 134
 - Technical data, 227
- U**
- USB charging socket
 - Position on the vehicle, 18
- V**
- Value
 - Display, 33
 - Vehicle Identification Number
 - Position on the vehicle, 19
- W**
- Warning indicator lights, 46
 - ABS, 52
 - Anti-theft alarm, 44
 - ASC, 54
 - ASC/DTC, 54
 - Bulb faulty, 43
 - Coolant temperature, 45
 - DWA, 45
 - Engine control unit, 47
 - Engine electronics, 46
 - Fuel reserve, 56
 - Gear not taught, 56
 - Keyless Ride, 41
 - Mode of presentation, 33
 - My vehicle, 107
 - On-board voltage, 41, 42
 - Outside temperature warning, 40
 - RDC, 48, 51
 - Warning light, drive malfunction, 45
 - Warning light, drive malfunction, 45, 46
 - Warning lights, 24
 - Overview, 28
 - Warnings, overview, 35

278 INDEX

Weights

Payload table, 20

Technical data, 230

Wheels

Change of size, 176

Checking rims, 176

Installing front wheel, 179

Installing rear wheel, 184

Removing front wheel, 177

Removing rear wheel, 182

Technical data, 227

Details described or illustrated in this booklet may differ from the vehicle's actual specification as purchased, the accessories fitted or the national-market specification. No claims will be entertained as a result of such discrepancies.

Dimensions, weights, fuel consumption and performance data are quoted to the customary tolerances.



The right to modify designs, equipment and accessories is reserved.

Errors and omissions excepted.

© 2021 Bayerische Motoren Werke Aktiengesellschaft
80788 Munich, Germany
Not to be reproduced by any means whatsoever, wholly or in part, without the written permission of BMW Motorrad, After Sales.
Original rider's manual, printed in Germany.

Important data for refuelling:

Fuel

Recommended fuel grade	 Premium unleaded (maximum 15% ethanol,  E15) 95 ROZ/RON 90 AKI
–with regular-grade fuel, unleaded ^{OE}	Regular, unleaded (control is national-market-specific) (maximum 15% ethanol, E15) 91 ROZ/RON 87 AKI
Recommended fuel grade	F 900 R A2 (0K31): see the section entitled "Technical data".
Fuel tank capacity	approx. 13 l
Reserve fuel	approx. 3.5 l
Tyre pressure	
Tyre pressure, front	2.5 bar, tyre cold
Tyre pressure, rear	2.9 bar, tyre cold

For further information on all aspects of your vehicle, visit: bmw-motorrad.com

