



BMW Motorrad



The Ultimate
Riding Machine

Rider's Manual F 800 GS

Vehicle data/dealership details

Vehicle data

Model

Vehicle Identification Number

Colour code

Date of first registration

Registration number

Dealership details

Person to contact in Service department

Ms/Mr

Phone number

Dealership address/phone number (company stamp)

Welcome to BMW

We congratulate you on your choice of a vehicle from BMW Motorrad and welcome you to the community of BMW riders. Familiarise yourself with your new vehicle so that you can ride it safely and confidently in all traffic situations.

About this Rider's Manual

Please read this Rider's Manual carefully before starting to use your new BMW. It contains important information on how to operate the controls and how to make the best possible use of all your BMW's technical features. In addition, it contains information on maintenance and care to help you maintain your vehicle's reliability and safety, as well as its value.

Suggestions and criticism

If you have questions concerning your motorcycle, your authorised BMW Motorrad dealer will gladly provide advice and assistance.

We hope you will enjoy riding your BMW and that all your journeys will be pleasant and safe

BMW Motorrad.

01 41 8 565 501



Table of Contents

1 General instructions 5	Fuel level..... 25	Damping 51
Overview 6	Fuel reserve..... 25	Electronic Suspension Ad-justment ESA 52
Abbreviations and symbols 6	Service-due indicator..... 26	Tyres..... 54
Equipment 7	Ambient temperature..... 26	Headlight 54
Technical data 7	Warnings 27	Seat 55
Actuality..... 7	4 Operation..... 35	Helmet holder..... 56
2 General views 9	Ignition switch 36	Rider's Manual 57
General view, left side 11	Electronic immobiliser 37	5 Anti-theft alarm
General view, right side 13	Clock..... 37	DWA 59
Underneath the seat 14	Reading 38	Overview 60
Underneath the trim panel 15	Stopwatch..... 39	Activation 60
Multifunction switch, left 16	Lights 41	Alarm function..... 62
Multifunction switch, right 18	Turn indicators 42	Deactivation 63
Instrument panel 19	Hazard warning flashers..... 42	Programming..... 64
3 Status indicators 21	Emergency off switch (kill switch) 43	Registration of the remote control 66
Multifunction display 22	Heated handlebar grips 43	Synchronising 67
Meaning of symbols..... 23	BMW Motorrad ABS 44	Battery 68
Warning and telltale lights 24	BMW Motorrad ASC 45	6 Riding..... 69
	Riding mode 46	Safety instructions 70
	Clutch 48	Comply with checklist 73
	Brakes 49	Starting..... 73
	Mirrors 50	
	Spring preload 50	

Running in	76	9 Maintenance	105	Restoring motorcycle to use	144
Speed	77	General instructions	106	11 Technical data	145
Off-roading	78	Toolkit.....	106	Troubleshooting chart.....	146
Brakes	79	Engine oil	107	Threaded fasteners	147
Parking your motorcycle	80	Brake system	109	Engine	149
Refuelling	80	Coolant.....	113	Fuel	150
Secure motorcycle for transportation	82	Clutch.....	114	Engine oil	151
7 Engineering details.....	85	Rims and tyres	115	Clutch	152
Riding mode	86	Chain.....	116	Transmission.....	152
Brake system with		Wheels	118	Transmission.....	152
BMW Motorrad ABS	87	Front-wheel stand.....	127	Rear-wheel drive	153
Electronic engine management with BMW Motorrad		Bulbs.....	128	Running gear.....	153
ASC	89	Body panels.....	134	Brakes	154
8 Accessories	91	Air filter.....	135	Wheels and tyres.....	154
General instructions	92	Jump-starting	136	Electrics	156
Power sockets	92	Battery	137	Frame	157
Luggage	93	10 Care	141	Dimensions	157
Auxiliary headlights	93	Care products.....	142	Weights	158
Cases	94	Washing the vehicle.....	142	Riding specifications	159
Topcase.....	97	Cleaning easily damaged		12 Service	161
Aluminium case	100	components.....	143	BMW Motorrad Service ...	162
Aluminium topcase.....	102	Paint care	143	BMW Motorrad Mobility	
		Laying up the motorcycle	144	services	162
		Protective wax coating	144	Maintenance work.....	162
				Maintenance schedule	165

Standard BMW service....	166
Confirmation of maintenance work	167
Confirmation of service....	172
13 Appendix.....	175
Certificate for electronic immobiliser	176
14 Index	178

General instructions

Overview	6
Abbreviations and symbols	6
Equipment	7
Technical data	7
Actuality	7

Overview

Chapter 2 of this Rider's Manual will provide you with an initial overview of your motorcycle. All maintenance and servicing work on the vehicle is documented in Chapter 11. This record of the maintenance work you have had performed on your vehicle is a precondition for generous treatment of goodwill claims.

When the time comes to sell your BMW, please remember to hand over this Rider's Manual; it is an important part of the motorcycle.

Abbreviations and symbols

 **CAUTION** Low-risk hazard. Non-avoidance can lead to slight or moderate injury.

 **WARNING** Medium-risk hazard. Non-avoidance can lead to fatal or severe injury.

 **DANGER** High-risk hazard. Non-avoidance leads to fatal or severe injury.

 **ATTENTION** Special notes and precautionary measures. Non-compliance can lead to damage to the vehicle or accessory and, consequently, to voiding of the warranty.

 **NOTICE** Specific instructions on how to operate, control, adjust or look after items of equipment on the vehicle.

◀ Indicates the end of an item of information.

• Instruction.

» Result of an activity.

 Reference to a page with more detailed information.

◁ Indicates the end of a passage relating to specific accessories or items of equipment.

 Tightening torque.

 Technical data.

OE Optional extras. The vehicles are assembled complete with all the BMW Motorrad optional extras originally ordered.

- OA Optional accessories. You can obtain BMW Motorrad optional accessories through your authorised BMW Motorrad dealer; optional accessories have to be retrofitted to the vehicle.
- EWS Electronic immobiliser.
- DWA Anti-theft alarm (Diebstahlwarnanlage).
- ABS Anti-lock brake system.
- ASC Automatic Stability Control.
- ESA Electronic Suspension Adjustment.

Equipment

When you ordered your BMW motorcycle, you chose various items of custom equipment. This Rider's Manual describes optional extras (OE) offered by BMW and selected optional accessories (OA). This explains why the manual may also contain descriptions of equipment which you have not ordered. Please note, too, that your motorcycle might not be exactly as illustrated in this manual on account of country-specific differences. If your BMW was supplied with equipment not described in this Rider's Manual, you will find these features described in separate manuals.

Technical data

All dimensions, weights and power ratings stated in the Rider's Manual are quoted to the standards and comply with the tolerance requirements of the Deutsches Institut für Normung e.V. (DIN). Versions for individual countries may differ.

Actuality

The high safety and quality standards of BMW motorcycles are maintained by constant development work on designs, equipment and accessories. Because of this, your motorcycle may differ from the information supplied in the Rider's Manual. Nor can BMW Motorrad entirely rule out errors and omissions. We hope you will appreciate that no claims can be entertained on the basis of the data, illustrations or descriptions in this manual.

General views

General view, left side	11
General view, right side	13
Underneath the seat	14
Underneath the trim panel	15
Multifunction switch, left	16
Multifunction switch, right	18
Instrument panel	19



General view, left side

- 1 Power socket (→ 92)
- 2 Seat lock (→ 55)
- 3 Engine-oil filler neck and oil dipstick (→ 107)



General view, right side

- 1 Fuel filler neck (▣▣▣ 81)
- 2 Adjuster, spring preload (▣▣▣ 50)
- 3 Brake-fluid reservoir, rear (▣▣▣ 112)
- 4 Brake-fluid reservoir, front (▣▣▣ 111)
- 5 VIN, type plate (on steering-head bearing)
- 6 Coolant level indicator (behind side panel) (▣▣▣ 113)
- 7 Adjuster for damping characteristic (▣▣▣ 51)

Underneath the seat

- 1 Stowage
– with first-aid kit^{OA}
Location of the first-aid kit
- 2 Standard tool kit (►► 106)
- 3 Payload table
- 4 Table of tyre pressures
- 5 Helmet holder (►► 56)
- 6 Rider's Manual (in rear of vehicle)
– with alarm system
(DWA)^{OE}
Rider's Manual (below control unit) (►► 57)
- 7 Tool for adjusting spring preload (►► 50)

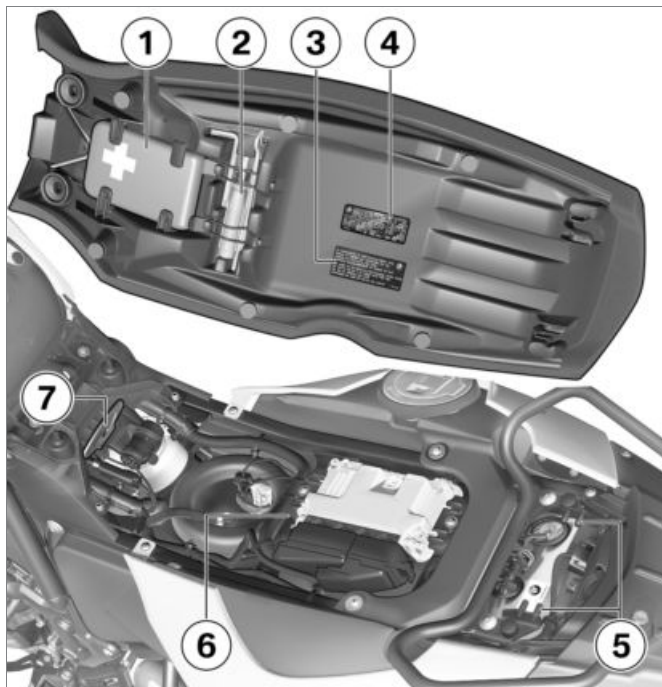

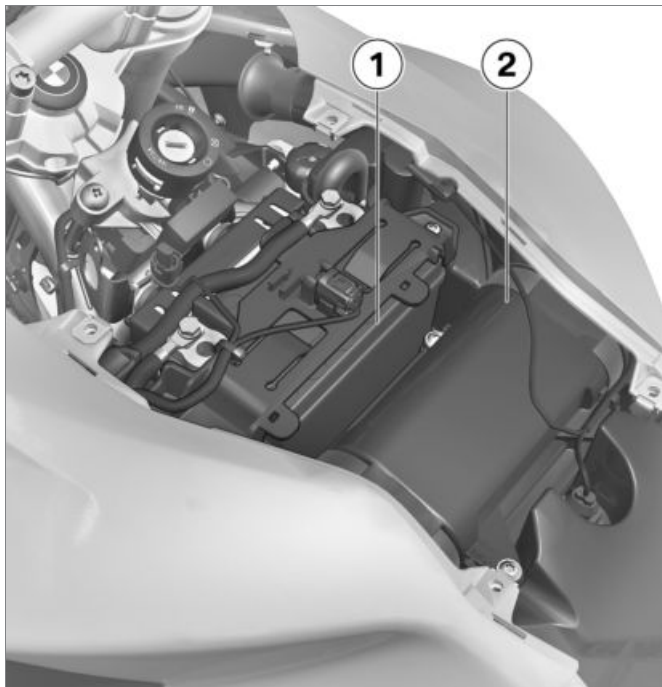



Underneath the trim panel

- 1 Battery (➡ 137)
- 2 Air-filter housing (➡ 135)

Multifunction switch, left

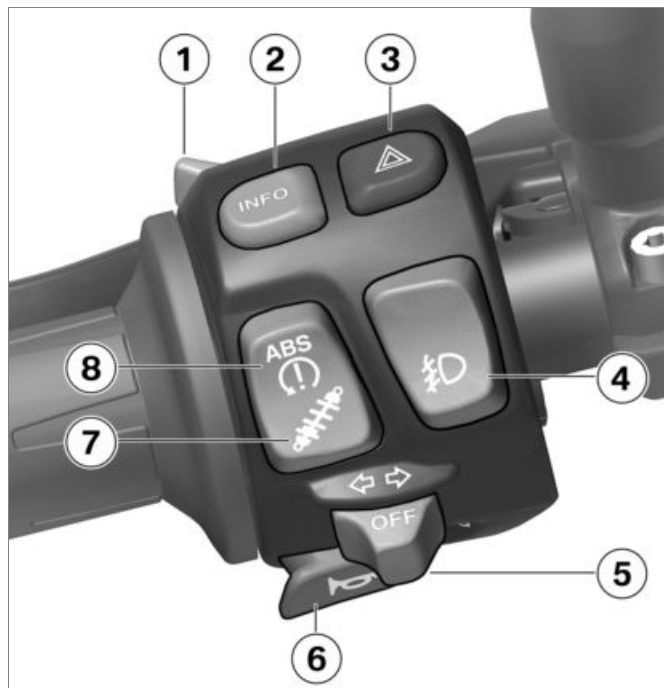
- 1 High-beam headlight and headlight flasher (➡ 41)
- 2 Select display (➡ 38).
– with on-board computer^{OE}
Resetting the average values (➡ 39).
- 3 Hazard warning flashers (➡ 42)
- 4 – with LED auxiliary headlights^{OA}
Operation of the auxiliary headlights (➡ 93)
- 5 Operation of the flashing turn indicators (➡ 42)
- 6 Horn
- 7 – with Electronic Suspension Adjustment (ESA)^{OE}
Operating ESA (➡ 52)
- 8



- 8** Operating the ABS
( 44)
– with Automatic Stability
Control (ASC)^{OE}
Operating ASC ( 45)

Multifunction switch, right

- 1 – with heated handlebar grips^{OE}
Grip heating control (→ 43)
- 2 – with off-road mode ABS and ASC^{OE}
Off-road mode (→ 47)
- 3 Starter button (→ 73)
- 4 Emergency off switch (kill switch) (→ 43)



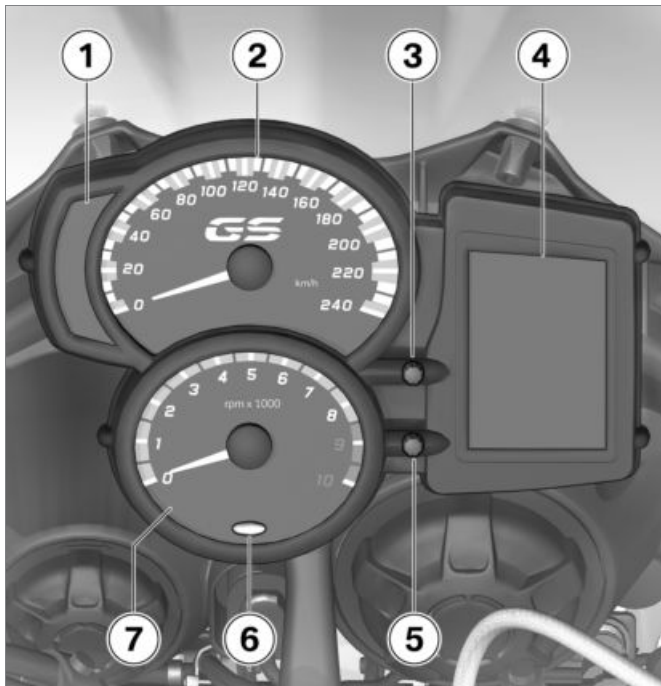

Instrument panel

- 1 Warning and telltale lights (➡ 24)
- 2 Speedometer
- 3 Setting clock (➡ 37).
– with on-board computer^{OE}
Operation of the stopwatch (➡ 39)
- 4 Multifunction display (➡ 22)
- 5 Select display (➡ 38).
Resetting tripmeter (➡ 39).

- 6** Ambient-light brightness sensor (for adapting the brightness of the instrument lighting)
- with alarm system (DWA)^{OE}
- Anti-theft alarm telltale light (see the instructions for use for the anti-theft alarm)
- with on-board computer^{OE}
- Redline warning (▣➔ 77)
- 7** Rev. counter

Status indicators

Multifunction display	22
Meaning of symbols	23
Warning and telltale lights.....	24
Fuel level	25
Fuel reserve	25
Service-due indicator	26
Ambient temperature	26
Warnings	27

Multifunction display

- 1 Warning for engine electronics (►► 31)
- 2 – with heated handlebar grips^{OE}
Display showing chosen level of grip heating (►► 43)
- 3 – with on-board computer^{OE}
Stopwatch (►► 39)
- 4 Time (►► 37)
- 5 Warning for coolant temperature (►► 30)
- 6 Service due (►► 26)
- 7 Value range of the odometer (►► 38)
- 8 Without indicator
– with on-board computer^{OE}
On-board computer readings (►► 38)
Symbols of the on-board computer (►► 23)



- 9** Coolant temperature display
- 10** Without indicator
– with on-board computer^{OE}
Gear indicator; "N" indicates neutral
- 11** Fuel level (▬▶ 25)
- 12** Setting riding mode
– with off-road mode ABS and ASC^{OE}
Adjust off-road mode (▬▶ 47).
- 13** A warning appears where the odometer reading is shown (▬▶ 27)
- 14** A tripmeter reading is displayed (▬▶ 38)

Meaning of symbols

– with on-board computer^{OE}



Distance travelled after fuel down to reserve (▬▶ 25)



Average consumption



Average speed



Current consumption



Ambient temperature (▬▶ 26)

Warning and telltale lights

- 1 ABS warning light (►► 32)
- 2 – with Automatic Stability Control (ASC)^{OE}
ASC warning light (►► 33)
- 3 Warning light for fuel down to reserve (►► 25) (►► 30)
- 4 General warning light, in combination with warnings in the display (►► 27)
- 5 High-beam headlight telltale light
- 6 Telltale light for right turn indicators
- 7 – with LED auxiliary headlights^{OA}
Telltale light for the auxiliary headlights (►► 93)
- 8 Telltale light for neutral indicators
- 9 Telltale light for left turn indicators





NOTICE

The ABS symbol might differ, depending on the specifics of national regulations.◀

Fuel level

Due to the complex shape of the fuel tank, it is impossible to determine the fuel level when the tank is approaching capacity. For this reason, the fill-level indicator only displays the bottom half of the filling capacity in detail.

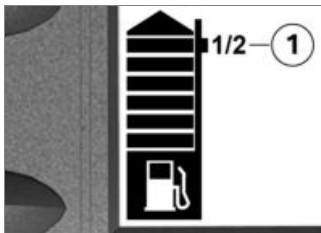

If the fill-level indicator reaches the 1 / 2-mark **1**, the fuel tank is half-full. From then on, the fill-level will be displayed more precisely.

If the fuel reserve is reached, the fuel warning light will come on.

Fuel reserve

The amount of fuel present in the fuel tank when the fuel warning light is switched on is dependent on vehicle dynamics. The more the fuel moves inside the tank (due to regularly changing angles of heel, frequent braking and acceleration), the more difficult it becomes to determine the reserve volume. For this reason, the fuel reserve volume cannot be displayed exactly.

– with on-board computer^{OE}



After the fuel warning light comes on, the distance that has travelled since this time is displayed.

The distance that can still be travelled using the reserve volume depends on the style of driving (usage) and the amount of fuel remaining at the time the light came on.

The odometer for the fuel reserve is reset when the amount of fuel is greater than the reserve volume.

Service-due indicator



If the next service is due in less than one month, the date for the next service **1** is shown briefly after the Pre-Ride Check completes. The month and year are displayed with two and four digits respectively, separated by a colon. In the example, the display represents “June 2014”.



If the vehicle covers long distances in the course of the year, under certain circumstances it might be necessary to have it serviced at a date in advance of the forecast due date. When the countdown distance to the odometer reading at which a service is due drops below 1000 km, the distance is counted down in steps of 100 km **1** and is shown briefly after the Pre-Ride Check completes.



If service is overdue, the due date or the odometer reading at which service was due

is accompanied by the 'General' warning light showing yellow. The word "Service" remains permanently visible.



NOTICE

If the service-due indicator appears more than a month before the service date, the date saved in the instrument cluster must be adjusted. This situation can occur if the battery was disconnected for a prolonged period of time.

If you want to have the date set consult a specialist workshop, preferably an authorised BMW Motorrad dealer. ◀

Ambient temperature

– with on-board computer^{OE}



When the motorcycle is at a standstill the heat of the engine can falsify the ambient-temperature reading. If the effect

of the engine's heat becomes excessive, -- temporarily appears on the display.

If ambient temperature drops below 3 °C the temperature display flashes to draw your attention to the risk of black ice forming. The display automatically switches from any other mode to the temperature reading when the temperature drops below this threshold for the first time.

Warnings

Mode of presentation

Warnings are indicated by the corresponding warning lights.

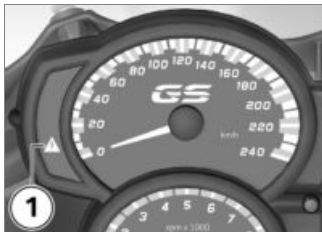

Warnings that do not have warning lights of their own are indicated by 'general' warning light **1** showing in combination with a text warning or a warning symbol in the multifunction display. The 'General' warning light shows red or yellow, depending on the urgency of the warning.

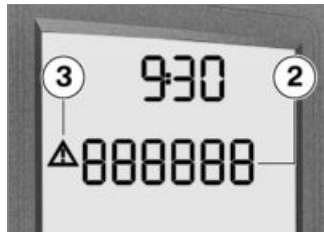

A reading in values area **2** that constitutes a warning is accompanied by warning triangle **3**. These warnings can alternate with the odometer readings (►► 38).













The status of the 'General' warning light matches the most urgent warning.

The possible warnings are listed on the next page.

Warnings, overview

Warning and telltale lights







Warning symbols in the display

		Warning symbols in the display	Meaning
	lights up yellow	 + "EWS" appears on the display	Electronic immobiliser active (►► 30)
	lights up		Fuel down to reserve (►► 30)
	lights up red	 flashes	Coolant temperature too high (►► 30)
	lights up yellow	 appears on the display	Engine in emergency-operation mode (►► 31)
	lights up yellow	 + "LAMP" appears on the display	Bulb defective (►► 31)
		"x . x °C" flashes	Outside temperature warning (►► 32)
	lights up yellow	 + "DWA" appears on the display	DWA battery flat (►► 32)
	flashes		ABS self-diagnosis not completed (►► 32)

Warning and telltale lights

Warning symbols in the display

Meaning

	lights up	ABS deactivated (▬▬▬▶ 33)
	lights up	ABS fault (▬▬▬▶ 33)
	quick-flashes	ASC intervention (▬▬▬▶ 33)
	slow-flashes	ASC self-diagnosis not completed (▬▬▬▶ 33)
	lights up	ASC deactivated (▬▬▬▶ 33)
	lights up	ASC fault (▬▬▬▶ 34)

Electronic immobiliser active



General warning light shows yellow.



+ "EWS" appears on the display.

Possible cause:

The key being used is not authorised for starting, or communication between key and engine electronics is disrupted.

- Remove all other vehicle keys from the same ring as the ignition key.
- Use the reserve key.
- Have the defective key replaced, preferably by an authorised BMW Motorrad dealer.

Fuel down to reserve



Warning light for fuel down to reserve shows.



WARNING

Irregular engine operation or engine shutdown due to lack of fuel.

Risk of accident. Damage to catalytic converter.

- Do not run the fuel tank dry. ◀

Possible cause:

The fuel tank contains no more than the reserve quantity of fuel.



Reserve fuel

min 2.7 l

- Refuelling (▣ 81).

Coolant temperature too high



General warning light shows red.



Temperature symbol flashes.



ATTENTION

Riding with overheated engine.

Engine damage

- Compliance with the information set out below is essential. ◀

Possible cause:

If the coolant level is too low.

- Checking coolant level (▣ 113).

If the coolant level is too low:

- Topping up coolant (▣ 114).

Possible cause:

The coolant temperature is too high.

- If possible, ride in the part-load range to cool down the engine.
- In traffic jams, switch off the engine, but leave the ignition switched on so that the radiator fan continues to operate.

- If the coolant temperature is frequently too high, have the fault rectified as soon as possible by a specialist workshop, preferably an authorised BMW Motorrad dealer.

Engine in emergency-operation mode



General warning light shows yellow.



Engine symbol appears on the display.



WARNING

Unusual ride characteristics when engine running in emergency-operation mode.

Risk of accident

- Adapt your style of riding accordingly.
- Avoid accelerating sharply and overtaking.◀

Possible cause:

The engine control unit has diagnosed a fault. In exceptional cases, the engine stops and refuses to start. Otherwise, the engine runs in emergency operating mode.

- You can continue to ride, but bear in mind that the usual engine performance might not be available.
- Have the fault rectified as quickly as possible by a specialist workshop, preferably an authorised BMW Motorrad dealer.

Bulb defective



General warning light shows yellow.



+ "LAMP" appears on the display.



WARNING

Failure of lights on the vehicle adds to possibility of other road users overlooking the vehicle.

Safety risk

- Replace defective bulbs as soon as possible; always carry a complete set of spare bulbs if possible.◀

Possible cause:

Bulb defective.

- Visually inspect to ascertain which bulb is defective.
- Replacing low-beam and high-beam headlight bulb (►► 128).
- Replacing parking-light bulb (►► 129).
- Replacing LED for brake light and tail light (►► 131).
- Replacing bulbs for front and rear turn indicators (►► 131).

- with LED auxiliary headlights^{OA}
- Replace auxiliary headlights (▶▶▶ 133).

Outside temperature warning

- with on-board computer^{OE}

"x . x °C" (ambient temperature) flashes.

Possible cause:

The air temperature measured at the motorcycle is lower than 3 °C.



WARNING

Risk of black ice forming at temperatures above 3 °C, even though no ambient-temperature warning is issued.

Risk of accident due to icy surface.

- Always take extra care when temperatures are low; remember that there is

particular danger of black ice forming on bridges and where the road is in shade.◀

- Ride carefully and think well ahead.

DWA battery flat

- with alarm system (DWA)^{OE}



General warning light shows yellow.



+ "DWA" appears on the display.



NOTICE

This error message shows briefly only after the Pre-Ride-Check completes.◀

Possible cause:

The integral battery in the anti-theft alarm has lost its entire original capacity. There is no assurance that the anti-theft alarm

will be operational if the vehicle's battery is disconnected.

- Seek the advice of a specialist workshop, preferably an authorised BMW Motorrad dealer.

ABS self-diagnosis not completed



ABS telltale and warning light flashes.

Possible cause:

The ABS function is not available, because self-diagnosis did not complete. The motorcycle has to move forward a few metres for the wheel sensors to be tested.

- Pull away slowly. Bear in mind that the ABS function is not available until self-diagnosis has completed.

ABS deactivated



ABS telltale and warning light shows.

Possible cause:

The rider has switched off the ABS system.

- Activate ABS function (▣▣▣ 45).

ABS fault



ABS telltale and warning light shows.

Possible cause:

The ABS control unit has detected a fault.

- You can continue to ride. Bear in mind that the ABS function is not available. Bear in mind the more detailed information on certain situations that can lead to ABS fault messages (▣▣▣ 88).
- Have the fault rectified as quickly as possible by a specialist workshop, preferably

an authorised BMW Motorrad dealer.

ASC intervention

- with Automatic Stability Control (ASC)^{OE}



ASC telltale and warning light quick-flashes.

The ASC has detected a degree of instability at the rear wheel and has intervened to reduce torque. The warning light flashes for longer than ASC intervention lasts. This affords the rider visual feedback on control intervention even after the critical situation has been dealt with.

ASC self-diagnosis not completed

- with Automatic Stability Control (ASC)^{OE}



ASC telltale and warning light slow-flashes.

Possible cause:

Self-diagnosis did not complete, so the ASC function is not available. The engine must be running and the motorcycle must reach a speed of at least 5 km/h in order for ASC self-diagnosis to complete.

- Pull away slowly. Bear in mind that the ASC function is not available until self-diagnosis has completed.

ASC deactivated

- with Automatic Stability Control (ASC)^{OE}



ASC telltale and warning light shows.

Possible cause:

The rider has switched off the ASC system.

- Activate ASC

ASC fault

– with Automatic Stability Control (ASC)^{OE}



ASC telltale and warning light shows.

Possible cause:

The ASC control unit has detected a fault. The ASC function is not available.

- You can continue to ride. Bear in mind that the ASC function is not available. Bear in mind the more detailed information on situations that can lead to an ASC fault (▮▮▮▮▶ 89).
- Have the fault rectified as quickly as possible by a specialist workshop, preferably

an authorised BMW Motorrad dealer.

Operation

Ignition switch	36	Brakes	49
Electronic immobiliser	37	Mirrors	50
Clock	37	Spring preload	50
Reading.....	38	Damping.....	51
Stopwatch	39	Electronic Suspension Adjustment ESA	52
Lights.....	41	Tyres	54
Turn indicators.....	42	Headlight	54
Hazard warning flashers.....	42	Seat	55
Emergency off switch (kill switch).....	43	Helmet holder	56
Heated handlebar grips	43	Rider's Manual.....	57
BMW Motorrad ABS.....	44		
BMW Motorrad ASC.....	45		
Riding mode	46		
Clutch	48		

Ignition switch

Keys

You receive 2 ignition keys. Please consult the information on the electronic immobiliser (EWS) if a key is lost or mislaid (►► 37). Ignition switch, fuel filler cap lock and seat lock are all operated with the same key.

- with cases^{OA}
- with topcase^{OA}

If you wish you can arrange to have the cases and the topcase fitted with locks that can be opened with this key as well. Consult a specialist workshop, preferably an authorised BMW Motorrad dealer.

Switching on ignition

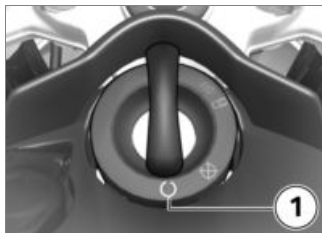

- Turn the key to position **1**.
 - » Parking lights and all function circuits switched on.
 - » Engine can be started.
 - » Pre-Ride-Check is performed (►► 74).
 - » ABS self-diagnosis is in progress (►► 75).
- with Automatic Stability Control (ASC)^{OE}
 - » ASC self-diagnosis is performed (►► 75).◀

Switch off the ignition



- Turn the key to position **2**.
 - » Lights switched off.
 - » Handlebars not locked.
 - » Key can be removed.
 - » Electrically powered accessories remain operational for a limited period of time.
 - » The battery can be recharged via the on-board socket.

Locking handlebars

- Turn the handlebars all the way to left



engine to be started if the key is identified as “authorised”.

NOTICE

A spare key attached to the same ring as the ignition key used to start the engine could “irritate” the electronics, in which case the enabling signal for starting is not issued. The EWS warning appears in the multifunction display.

Always keep the spare key separately from the ignition key. ◀

If you lose a key, you can have it barred by your authorised BMW Motorrad dealer. If you wish to do this, you will need to bring all other keys for the motorcycle with you.

The engine cannot be started by a barred key, but a key that has been barred can subsequently be reactivated.

- Turn the key to position **3**, while moving the handlebars slightly.
- » Ignition, lights and all function circuits switched off.
- » Handlebars locked.
- » Key can be removed.

Electronic immobiliser

The electronic design of the motorcycle allows it to access data stored in the ignition key by means of a ring antenna located in the ignition switch. The engine control unit will only allow the en-

You can obtain emergency/extra keys only through an authorised BMW Motorrad dealer. The keys are part of an integrated security system, so the dealer is under an obligation to check the legitimacy of all applications for replacement/extra keys.

Clock

Setting clock

WARNING

Adjusting the clock while riding.

Risk of accident

- Set the clock only when the motorcycle is stationary. ◀
- Switch on the ignition.

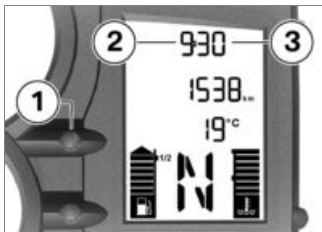

- Press and hold down button **1** until the hours number **2** flashes.
- Repeatedly press the button until the hours number is correct.
- Press and hold down the button until the minutes number **3** flashes.
- Repeatedly press the button until the minutes number is correct.
- Hold down the button until the minutes number stops flashing.
- » This completes the process.

Reading

Select display



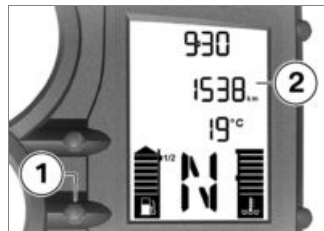

- Switch on the ignition.



- Press button **1** to select the reading in values area **2**.
- The following values can be displayed:
- Odometer (shown)
 - Tripmeter 1 (Trip I)
 - Tripmeter 2 (Trip II)
 - Warnings, if applicable

– with on-board computer^{OE}



- Press button **1** to select the reading in values area **2**.
- The following values can be displayed:
- Ambient temperature (°C)
 -  Average speed in km/h
 -  Average consumption in l/100 km
 -  Current consumption in l/100 km
 -  distance travelled after fuel down to reserve in km<

Resetting tripmeter

- Switch on the ignition.
- Select the desired tripmeter.

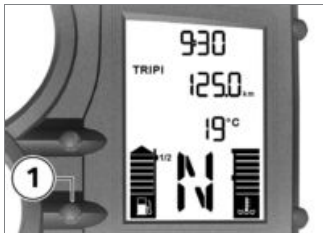

- Press and hold down button **1** until the tripmeter reading is reset.

Resetting the average values

– with on-board computer^{OE}

- Switch on the ignition.
- Select average consumption or average speed.



- Press and hold down button **1** until the value shown is reset.

Stopwatch

– with on-board computer^{OE}

Stopwatch

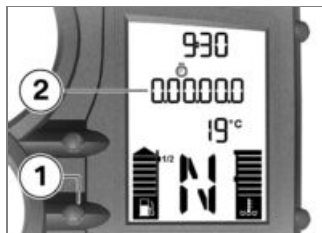

You can switch from the odometer reading to a stopwatch **2**. The readout is in hours, minutes, seconds and tenths of a second, with dots as separators. By swapping the functions of button **1** and the INFO button on the handlebar fitting you can make the stopwatch easier to use (as a lap timer) as you ride. If you swap the functions in this way the stopwatch and the odometer are operated by means of the INFO button and you must

use button **1** to operate the on-board computer.

The stopwatch continues to time in the background if you switch back temporarily to the odometer reading. Similarly, the stopwatch continues timing if you temporarily switch off the ignition.

Operating stopwatch

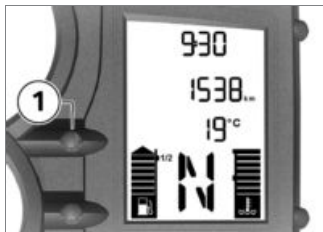

- If necessary, use button **1** to switch from the odometer to the stopwatch.

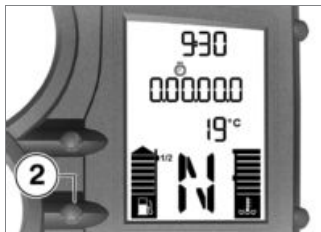

- When the stopwatch is stopped, press button **2** to start timing with the stopwatch.
- When the stopwatch is running, press button **2** to stop timing with the stopwatch.
- Press and hold down button **2** to reset the stopwatch.

Changing button functions

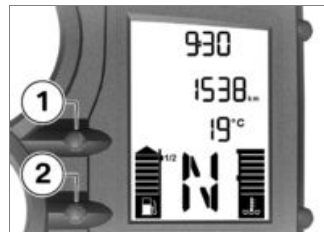

- Press button **1** and button **2** at the same time and hold them down until the reading changes.
 - » FLASH (redline warning) appears, along with ON or OFF.
- Press button **2**.
 - » LAP (Lap-Timer) and ON or OFF appear.
- Repeatedly press button **1** until the reading shows the mode you want.

- » ON: Stopwatch operated by means of the INFO button on the handlebar fitting.
- » OFF: Stopwatch operated by means of button **2** in the instrument panel.
- To save the setting, press button **1** and button **2** at the same time and hold them down until the reading changes.

Lights

Side light

The side lights switch on automatically when the ignition is switched on.



NOTICE

The side lights place a strain on the battery. Do not switch the ignition on for longer than absolutely necessary.◀

Low-beam headlight

The low-beam headlight comes on automatically under the following conditions:

- If the engine is started
- If the vehicle is pushed while the ignition is on.



NOTICE

When the engine is not running you can switch on the lights by switching on the ignition and either switching on the high-beam headlight or operating the headlight flasher.◀

High-beam headlight and headlight flasher



- Push switch **1** forward to switch on the high-beam headlight.
- Pull switch **1** back to operate the headlight flasher.

Parking light

- Switch off the ignition.



- Immediately after switching off the ignition, push button **1** to the left and hold it in this position until the parking lights come on.
- Switch the ignition on and off again to switch off the parking lights.

Turn indicators

Operating the turn indicators

- Switch on the ignition.



NOTICE

The turn indicators are cancelled automatically after the defined time and distance. The defined time and distance can be set by an authorised BMW Motorrad dealer. ◀



- Push button **1** to the left to switch on the left turn indicators.
- Push button **1** to the right to switch on the right turn indicators.

- Operate centre button **1** to cancel the turn indicators.

Hazard warning flashers

Operate hazard warning flashers

- Switch on the ignition.



NOTICE

The hazard warning flashers place a strain on the battery. Do not use the hazard warning flashers for longer than absolutely necessary. ◀



NOTICE

If you press a turn-indicator button with the hazard warning flashers switched on, the turn-indicator function is activated instead of the hazard warning flashers, and remains active until you release the button.

The hazard warning flashers recommence flashing as soon as the button is released.◀



- Press button **1** to switch on the hazard warning flashers.
» Ignition can be switched off.
- Press button **1** again to switch off the hazard warning flashers.

Emergency off switch (kill switch)



- 1** Emergency off switch (kill switch)

WARNING

Operation of the kill switch while riding.

Risk of fall due to rear wheel locking.

- Do not operate the kill switch when riding.◀

The emergency off switch is a kill switch for switching off the engine quickly and easily.



- a** Engine switched off
b Normal operating position (run)

Heated handlebar grips

– with heated handlebar grips^{OE}

Operating heated handlebar grips

- Start the engine.

NOTICE

The heating in the heated handlebar grips can be activated only when the engine is running.◀

NOTICE

The increase in power consumption caused by having the heated handlebar grips switched on can drain the battery if you are riding at low engine speeds. If the charge level is low, the heated handlebar grips are switched off to ensure the battery's starting capability.◀

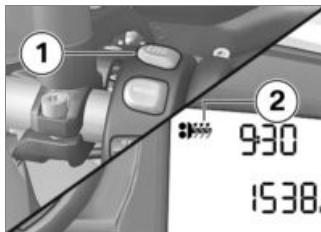

- Repeatedly press button **1** until desired heating stage **2** appears on the display.



The handlebar grips have two-stage heating. Stage two **2** is for heating the grips quickly: it is advisable to switch back to

stage one as soon as the grips are warm.



50 % heating power



100 % heating power

» The selected heating stage will be saved if you allow a certain length of time to pass without making further changes.

BMW Motorrad ABS **Deactivate ABS function**

- Bring the motorcycle to a stop or, if the motorcycle is at a standstill, switch on the ignition.



- Press and hold down button **1** until the ABS warning light changes status.

 ABS telltale and warning light shows.

– with Automatic Stability Control (ASC)^{OE}

- » Initially, the ASC symbol changes status. Press and hold down button **1** until the ABS warning light responds. Under these circumstances there is no change in the ASC setting.◀

- Release button **1** within two seconds.

 ABS telltale and warning light remains on.

- » The ABS function is deactivated.

Activate ABS function



- Press and hold down button **1** until the ABS warning light changes status.

 ABS telltale and warning light goes out; if self-diagnosis has not completed it starts flashing.

- Release button **1** within two seconds.

 ABS telltale and warning light remains off or continues to flash.

- » The ABS function is activated.
- You also have the option of switching the ignition off and then on again.



NOTICE

An ABS fault has occurred if the ABS telltale and warning light shows when the motorcycle accelerates to a speed in excess of 5 km/h after the ignition was switched off and then on again.◀

BMW Motorrad ASC

– with Automatic Stability Control (ASC)^{OE}



Deactivate ASC function

- Switch on the ignition.

NOTICE

You have the option of deactivating the ASC function while the motorcycle is on the move. ◀





- Press and hold down button **1** until the ASC warning light changes status.
-  ASC telltale and warning light shows.
- Release button **1** within two seconds.
-  ASC telltale and warning light remains on.

» The ASC function is deactivated.

Activate ASC function



- Press and hold down button **1** until the ASC warning light changes status.
-  ASC telltale and warning light goes out; if self-diagnosis has not completed it starts flashing.
- Release button **1** within two seconds.
-  ASC telltale and warning light remains off or continues to flash.

» The ASC function is activated.

- You also have the option of switching the ignition off and then on again.

NOTICE

An ASC fault has occurred if the ASC telltale and warning light shows when the motorcycle accelerates to a speed in excess of 5 km/h after the ignition was switched off and then on again. ◀

Riding mode

Riding mode

– with off-road mode ABS and ASC^{OE}

BMW Motorrad has developed two operational scenarios for your motorcycle from which you can select the scenario suitable for your situation:

- ROAD: On-road riding
- ENDURO: Off-road mode

In both the ABS and ASC systems, the level of wheel slip is optimised for each riding surface.

NOTICE

Detailed information regarding the off-road mode can be found in the section entitled "Engineering details". ◀

Adjust off-road mode

- with off-road mode ABS and ASC^{OE}

Prerequisite: On-road riding is active.

ATTENTION

Activation of the off-road mode (Enduro) when riding on-road.

Risk of crash due to lack of stability when the vehicle brakes or

accelerates in the control range of ABS or ASC.

- Switch on the off-road mode (enduro) for off-roading only. ◀
- Switching on ignition (III → 36).

NOTICE

If a riding mode was selected prior to switching the ignition off, it remains further active after a new starting. ◀



- Press button **1**.
 - » Mode adjustment is activated.
 - » Symbol for on-road riding **2** flashes.

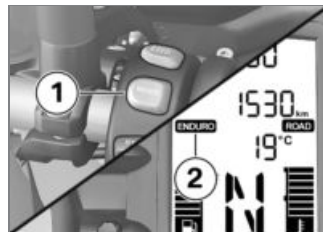

- Operate button **1** again.
 - » Symbol for off-road mode **2** flashes.
 - » **While riding:** If the prerequisites for riding mode adjustments mentioned below are met, the off-road mode is activated:
 - Throttle twistgrip in idle position
 - Brake not applied
 - Clutch pulled
 - » **At standstill:** Activation takes place after approx. 2 seconds.
 - » Symbol for off-road mode **2** is continuously displayed.

» Symbol for on-road riding is suppressed.

Adjust on-road riding

– with off-road mode ABS and ASC^{OE}

Prerequisite: Off-road mode is active.

• Switching on ignition (➡ 36).

NOTICE

If a riding mode was selected prior to switching the ignition off, it remains further active after a new starting. ◀

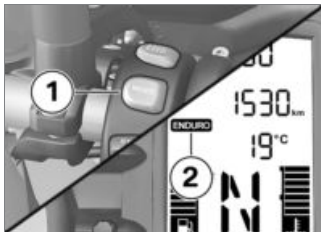

- Press button **1**.
- » Mode adjustment is activated.
- » Symbol for off-road mode **2** flashes.

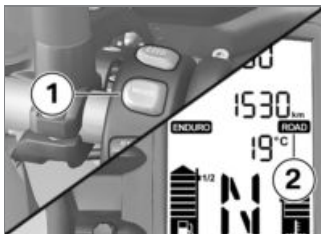

- Operate button **1** again.

» Symbol for on-road riding **2** flashes.

» **While riding:** If the prerequisites for riding mode adjustments mentioned below are met, the on-road mode is activated:

- Throttle twistgrip in idle position
- Brake not applied
- Clutch pulled
- » **At standstill:** Activation takes place after approx. 2 seconds.
- » Symbol for on-road riding **2** is continuously displayed.
- » Symbol for off-road mode is suppressed.

Clutch

Adjusting clutch lever

! WARNING

Adjusting the clutch lever while riding.

Risk of accident

- Do not attempt to adjust the clutch lever unless the motorcycle is at a standstill.◀

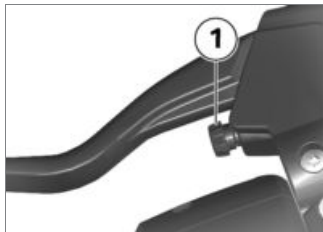

- Turn adjusting screw **1** clockwise to increase the span between the clutch lever and the handlebar grip.
- Turn adjusting screw **1** counter-clockwise to reduce the span between the clutch lever and the handlebar grip.

 **NOTICE**

The adjusting screw is easier to turn if you push the clutch lever forward.◀

Brakes

Adjust the handbrake lever

 **WARNING**

Changed position of the brake fluid reservoir.

Air in the brake system.

- Do not turn the handlebars or the handlebar fitting on the handlebar.◀

 **WARNING**

Adjusting the brake lever while riding.

Risk of accident

- Do not attempt to adjust the brake lever unless the motorcycle is at a standstill.◀

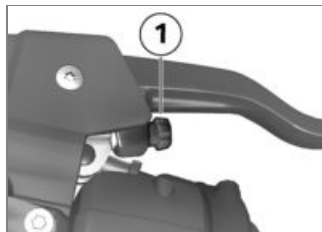

- Turn adjusting screw **1** clockwise to increase the span between the brake lever and the handlebar grip.
- Turn adjusting screw **1** counter-clockwise to reduce the span between the brake lever and the handlebar grip.

 **NOTICE**

The adjusting screw is easier to turn if you push the brake lever forward.◀

Mirrors

Adjusting mirrors



- Turn the mirror to the desired position.

Adjusting mirror arm



- Push protective cap **1** up over the threaded fastener on the mirror arm.
- Slacken nut **2**.
- Turn the mirror arm to the appropriate position.
- Tighten the nut to the specified tightening torque, while holding the mirror arm to ensure that it does not move out of position.



Locknut (mirror) to clamping piece

Joining compound: Multi-wax spray

20 Nm

- Push the protective cap over the threaded fastener.

Spring preload

Setting

It is essential to set spring preload of the rear suspension to suit the load carried by the motorcycle. Increase spring preload when the motorcycle is heavily loaded and reduce spring preload accordingly when the motorcycle is lightly loaded.

Adjust spring preload for rear wheel

- Removing seat (▶▶▶ 55).

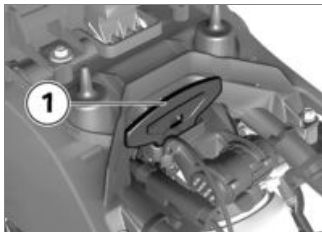

- Remove on-board toolkit **1**.



! WARNING

Spring preload setting and spring-strut damping setting not matched.

Impaired handling.

- Adjust spring-strut damping to suit spring preload.◀
- If you want to increase spring preload, use the tool from the on-board toolkit to turn knob **2** clockwise.
- If you want to reduce spring preload, use the tool from the on-board toolkit to turn knob **2** counter-clockwise.



Basic setting of spring preload, rear

Turn the dial counter-clockwise as far as it will go (One-up riding without luggage)

Turn the dial counter-clockwise as far as it will go, then make 12 clockwise rotations (One-up riding with luggage)

Turn the dial clockwise as far as it will go (Two-up riding and luggage)

- Stow the on-board toolkit in its correct position.
- Installing seat (▶▶▶ 56).

Damping Setting

Damping must be adapted to suit the condition of the surface on which the motorcycle is ridden and to suit spring preload.

- An uneven surface requires softer damping than a smooth surface.
- An increase in spring preload requires firmer damping, a reduction in spring preload requires softer damping.

Adjust the damping for rear wheel

- Make sure the ground is level and firm and place the motorcycle on its stand.

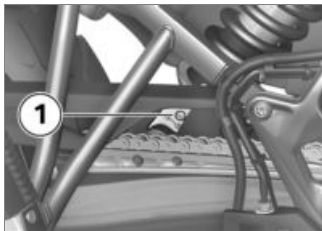

- Adjust the damping characteristic by turning adjusting screw **1**.



- If you want a harder damping characteristic, turn adjusting

screw **1** in the direction indicated by the H arrow.

- If you want a softer damping characteristic, turn adjusting screw **1** in the direction indicated by the S arrow.



Basic setting of rear-suspension damping characteristic

– without Electronic Suspension Adjustment (ESA)^{OE}

Turn the adjusting screw as far as it will go in the clockwise direction and then back it off one and a half turns (One-up without luggage)

Turn the adjusting screw as far as it will go in the clockwise direction and then back it off one and a half turns (One-up with luggage)



Basic setting of rear-suspension damping characteristic

Turn the adjusting screw as far as it will go in the clockwise direction and then back it off 1 turn (Two-up with luggage) <

Electronic Suspension Adjustment ESA

– with Electronic Suspension Adjustment (ESA)^{OE}

Possible settings

With the help of Electronic Suspension Adjustment (ESA), you can calibrate the rear-wheel damping to the terrain with ease. Three settings are available for damping.

Call up settings

- Switch on the ignition.



- Press button **1** to view the current setting.

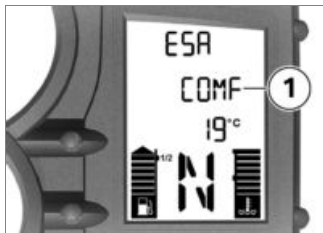

The currently selected damping is shown on the multifunction

display at **1**. The meanings of the readings are as follows:

- COMF Comfortable damping characteristic
- NORM Normal damping characteristic
- SPORT Sporty damping characteristic

» The setting shows briefly, then disappears automatically.

Adjust the chassis and suspension

- Switch on the ignition.



- Press button **1** to view the current setting.

To make different adjustment to the damping:

- Repeatedly press button **1** until the setting you want to use appears on the display.



NOTICE

You can adjust the damping characteristic while the motorcycle is on the move. ◀

» The setting shown on the display is automatically accepted as the damping characteristic if you allow a

- certain length of time to pass without pressing button **1**.
- » The ESA indicator disappears from the display as soon as adjustment completes.

Tyres

Checking tyre pressure



WARNING

Incorrect tyre pressure.

Impairment of the motorcycle's handling characteristics. Shorter useful tyre life.

- Always check that the tyre pressures are correct. ◀



WARNING

Tendency of valve inserts installed vertically top open by themselves at high riding speeds.

Sudden loss of tyre pressure.

- Install valve caps fitted with rubber sealing rings and tighten firmly. ◀
- Make sure the ground is level and firm and place the motorcycle on its stand.
- Check tyre pressures against the data below.



Tyre pressure, front

2.2 bar (one-up, tyre cold)

2.5 bar (two-up and/or with luggage, tyre cold)



Tyre pressure, rear

2.5 bar (one-up, tyre cold)

2.9 bar (two-up and/or with luggage, tyre cold)

If tyre pressure is too low:

- Correct tyre pressure.

Headlight

Adjusting headlight for driving on left/driving on right

If the motorcycle is ridden in a country where the opposite rule of the road applies, its asymmetric low-beam headlight will tend to dazzle oncoming traffic. Have the headlight set accordingly by a specialist workshop, preferably an authorised BMW Motorrad dealer.

Headlight beam throw and spring preload

Headlight beam throw is generally kept constant when spring preload is adjusted to suit load. Spring preload adjustment might not suffice only if the motorcycle is very heavily loaded. Under these circumstances, headlight beam throw has to be adjusted

to suit the weight carried by the motorcycle.

NOTICE

If there are doubts about the correct headlight beam throw, have the setting checked by a specialist workshop, preferably an authorised BMW Motorrad dealer. ◀

Adjusting headlight beam throw



- Slacken screws **1** on left and right.

- Adjust beam throw by tilting the headlight slightly about its horizontal axis.
- Tighten screws **1** on left and right.

Beam-throw basic setting

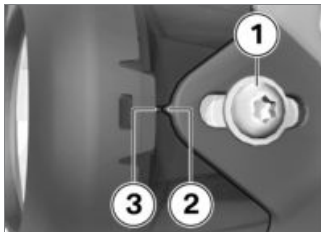

- Slacken screws **1** on left and right.
- Tilt the headlight slightly about its horizontal axis until arrowhead **2** is pointing toward marker **3**.
- Tighten screws **1** on left and right.

Seat

Removing seat

- Make sure the ground is level and firm and place the motorcycle on its stand.



- Turn the key to the left in seat lock **1** and hold it in this position while pressing down the front part of the seat.

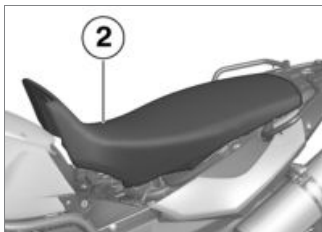

- Lift seat **2** at the front and release the key.
- Remove the seat and place it, rubber buffers down, on a clean surface.

Installing seat



- Engage the seat in holders **3**.
 - Firmly press down on the seat at the front.
- » The seat engages with an audible click.

Helmet holder

Securing helmet to motorcycle

- Removing seat (🔗 55).



- Use a plastic-sheathed steel cable to secure the helmet to helmet holder **1** on left or right.



ATTENTION

Attachment of the helmet on the left side of the vehicle.

Damage due to hot rear silencer.

- Attach the helmet on the right-hand side of the vehicle. ◀



ATTENTION

Incorrect positioning of the helmet lock.

Scratch marks on trim panel.

- Make sure the lock is out of the way when you hook the helmet into position. ◀

- Pass the steel cable through the helmet and the holder and position cable and helmet as shown here.
- Installing seat (→ 56).

Rider's Manual

Stowing the Rider's Manual

- Tuck the Rider's Manual(s) into the pocket provided.



- Make the opening side of the pocket as narrow as possible, then fasten the velcro **1**.

- Stowing the pocket in the rear of the vehicle.

– with alarm system (DWA)^{OE}

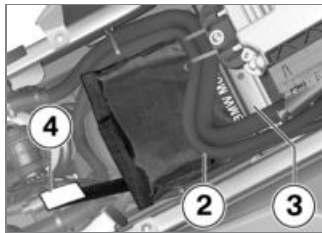

- Slightly raise the leads **2**.
- Push the pocket backwards underneath the cables and rear frame strut **3** until the rolled-up edge of the pocket is below the rear frame strut.
- Remove protective film **4** and attach the velcro to the pocket in such a way that it cannot slide around any further. ◀

Anti-theft alarm DWA

Overview	60
Activation	60
Alarm function	62
Deactivation	63
Programming	64
Registration of the remote control	66
Synchronising.....	67
Battery.....	68

Overview

– with alarm system (DWA)^{OE}

General information about the anti-theft alarm (DWA)

Any attempt to move the vehicle, change its position, start it without an authorised key or disconnect the starter battery will trigger the alarm. The sensitivity of the system is parameterised so that slight vibrations will not trigger the alarm. Once the system has been activated, any attempt to tamper with the vehicle is indicated acoustically by the siren and visually by all four turn indicators flashing in unison.

You can change some of your DWA alarm system's parameters to suit your personal preferences.

Conserving power in the vehicle's starter battery

In order to conserve the power of the starter battery and ensure that the vehicle will start, the DWA anti-theft alarm automatically switches off the alarm function a few days after being activated. In most cases, however, the system will remain active for at least 10 days.

Radio interference

Radio systems or devices transmitting on the same frequency as the remote control of the DWA anti-theft alarm can interfere with operation of the system. If problems of this nature occur, point the remote control toward the vehicle from another direction.

Controls

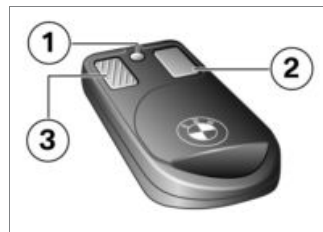

- 1 LED
- 2 Right button (▣ 62)
- 3 Left button (ribbed) (▣ 61)

Activation

– with alarm system (DWA)^{OE}

Activation with motion sensor



- The alarm function is activated
- by pressing button **1** on the remote control once, or
 - by switching off the ignition (if programmed); when the ignition is switched off 30 seconds elapse before the start of the activation phase.

Activation is confirmed

- by the turn indicators flashing twice and
- by the alarm tone sounding twice.

If you want to activate the alarm function more than one minute after switching off the ignition, you must press button **1** for longer than one second.

Activation phase

The anti-theft alarm needs 15 seconds to achieve fully active status. No alarm is triggered during this time.

Conserving battery power in the control unit (anti-theft alarm activated)



If you want to activate the alarm function more than one minute after switching off the ignition, you must press button **1** for longer than one second. If it remains deactivated for approximately one hour, the anti-theft alarm shuts down in order not to draw power unnecessarily from the battery. If you want to activate the alarm function after the anti-theft alarm has shut down in

this way, you have to switch the ignition on and then off again.

Motion sensor when motorcycle is to be transported

If you want to transport your motorcycle by train or on a trailer, for example, it is advisable to switch off the motion sensor. If the motion sensor is not switched off the severe movements occurring in transit could trigger the alarm.

Deactivating motion sensor



- Press button **1** on the remote control a second time during the activation phase.
 - » Turn indicators flash three times.
 - » Alarm tone sounds three times.
 - » Motion sensor is deactivated.

Alarm function

- with alarm system (DWA)^{OE}

Alarm triggers

An alarm can be triggered by:

- the motion sensor
- attempt to switch on the ignition with an unauthorised key
- disconnection of the anti-theft alarm (DWA) from the vehicle's battery (DWA internal battery in the anti-theft alarm provides power).

Alarm



An alarm lasts for 26 seconds. The system is active again another 12 seconds later. You can interrupt an alarm at any time by pressing button **1** on the remote

control. This function does not change the status of the anti-theft alarm.

While an alarm is in progress an alarm tone sounds and the turn indicators flash. You can program the type of alarm tone.

Reason for an alarm

Once you have deactivated the alarm function, the anti-theft alarm LED is active for a period of one minute to show you reasons for alarms, if any, that were triggered in your absence:

- Flashes 1x: Motion sensor; motorcycle was rocked forward/back
- Flashes 2x: Motion sensor; motorcycle was rocked to the side
- Flashes 3x: Ignition switched on with unauthorised key
- Flashes 4x: Disconnection of the anti-theft alarm from the vehicle's battery

Information on alarm triggering

If an alarm was triggered after the last activation of the alarm function, the rider is notified accordingly by an alarm tone sounding once when the ignition is switched on.

Deactivation

– with alarm system (DWA)^{OE}

Deactivating alarm function



- Press button **1** on the remote control once **or** switch on the ignition with an authorised key.



NOTICE

Note that you can deactivate the alarm function with the ignition key only when the kill switch is in the RUN position. ◀



NOTICE

If the alarm function is deactivated by the remote control and

the ignition is not subsequently switched on, the alarm function automatically goes active again after 30 seconds if "Activation after ignition OFF" is programmed. ◀

- » Turn indicators flash once.
- » Alarm tone sounds once (if programmed).
- » Alarm function is deactivated.

Conserving battery power (anti-theft alarm deactivated)

Approximately one hour after the alarm is armed, the receiver for the remote control in the anti-theft alarm shuts down in order not to draw power unnecessarily from the battery. If you want to deactivate the alarm function after the receiver has shut down in this way, you have to switch the ignition on.

Programming

- with alarm system (DWA)^{OE}

Programming options

You can customise the following parameters of your anti-theft alarm:

- Confirmation alarm tone after activation/deactivation of the anti-theft alarm in addition to visual confirmation by turn indicators flashing
- Rising and falling or intermittent alarm tone
- Automatic activation of the alarm function after the ignition is switched off

Default settings

- The anti-theft alarm ships with the following default settings:
- Confirmation alarm tone after activation/deactivation of the anti-theft alarm: No
 - Alarm tone: Intermittent

- Automatic activation of the alarm function after the ignition is switched off: No

Programming anti-theft alarm



- Deactivate the alarm function.
- Switch on the ignition.
- Press button **1** three times.
 - » Acknowledgement tone sounds once.
- Within ten seconds, switch off the ignition.
- Press button **2** three times.
 - » Acknowledgement tone sounds once.

- Within ten seconds, switch on the ignition.
- » Acknowledgement tone sounds three times.
- » The programming function is active.

Programming is a four-step process, although no function is allocated to step 2. The number of times the anti-theft alarm LED on the vehicle flashes corresponds to the active programming step. An alarm tone sounds by way of confirmation when button **1** is pressed, and an acknowledgement tone sounds when button **2** is pressed.

- **Step 1:** Do you want a confirmation tone to sound after activation/deactivation of the anti-theft alarm?

Yes:

- Press button **1**.

No:

- Press button **2**.

- **Step 2:**

No function allocated to this step.

- Press button **1** or button **2**.

- **Step 3:** Which alarm tone would you like the alarm to sound?

Rising and falling:

- Press button **1**.

intermittent:

- Press button **2**.

- **Step 4:** Do you want to have the alarm function activated automatically when you switch off the ignition?

Yes:

- Press button **1**.

No:

- Press button **2**.

Under what circumstances is programming aborted?

There are two ways in which programming can be cancelled:

- if the ignition is switched off before completion of the last step in the programming sequence.
- automatically if more than 30 seconds are allowed to elapse between any two consecutive steps in the programming routine.

The new settings are not saved if programming is aborted.

Saving programming

There are two ways in which programming can be saved:

- if the ignition is switched off after completion of the last step in the programming sequence

– automatically 30 seconds after completion of the last step in the programming routine

The anti-theft alarm LED goes out and four acknowledgement tones sound.

Registration of the remote control

– with alarm system (DWA)^{OE}

When is it necessary to register a remote control?

If you want to register an additional remote control or register a remote control as a replacement for one that has been mislaid, you must always register all the remote control units with the anti-theft alarm. You can register a maximum of four remote control units.

Registering remote control



- Deactivate the alarm function.
- Switch on the ignition.
- Press button **2** three times.
 - » Acknowledgement tone sounds once.
- Within ten seconds, switch off the ignition.
- Press button **2** three times.
 - » Acknowledgement tone sounds once.
- Within ten seconds, switch on the ignition.

» Acknowledgement tone sounds twice.

You can now register a maximum of four remote control units with the anti-theft alarm. Registration is a three-step process and has to be repeated for each remote control unit.

- Press and hold down button **1** and button **2**.
 - » LED flashes for ten seconds.
- As soon as the LED goes out, release button **1** and button **2**.
 - » LED lights up.
- Press button **1** or button **2**.
 - » Alarm tone sounds once.
 - » LED goes out.
 - » Remote control has been registered.
- Repeat this three-step procedure for each additional remote control.

Termination of registration

Registration is terminated in the following situations:

- 4 remote control units have been logged on.
- Ignition is switched OFF.
- 30 seconds elapse without a button being pressed after the ignition has been switched off.
- 30 seconds elapse without a button being pressed after a remote control unit has been registered.

When registration terminates the LED flashes and the acknowledgement tone sounds three times.

Synchronising

- with alarm system (DWA)^{OE}

When is it necessary to synchronise the remote control?

The remote control has to be synchronised if the buttons of the remote control have been pressed more than 256 times outside the receiver's range. Once this limit has been reached, the receiver on the vehicle will no longer react to the signals from the remote control.

Synchronising remote control



- Press and hold down button **1** and button **2**.
 - » LED flashes for ten seconds.
 - As soon as the LED goes out, release button **1** and button **2**.
 - » LED lights up.
 - Press button **1** or button **2**.
 - » LED goes out.
- Remote control has been synchronised.

Battery

– with alarm system (DWA)^{OE}

When does the battery have to be changed?

The batteries in the remote control are due to be changed after approximately 2-3 years. You can tell that the battery is weak if the LED does not light up or lights up only briefly when a button is pressed.

Changing battery

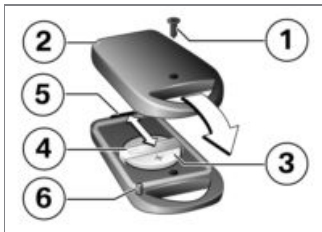

- Remove screw **1** and remove bottom part of housing **2**.

- Slide old battery **3** forward from under retainer **4**.



ATTENTION

Batteries unsuitable or not inserted in compliance with correct procedure.

Component damage

- Use only the specified type of battery (see "Technical Data").
- When inserting the battery, always make sure polarity is correct. ◀
- Slip the new battery into position, making sure that the positive terminal of the battery is facing up.
- Position the bottom part of the housing at projection **5** of the front edge and close the housing, noting two guide pins **6**.
- Install the screw.
- » The LED on the remote control lights up, indicating that the

remote control has to be activated.

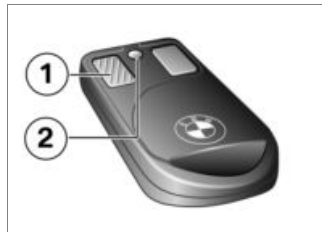

- To activate the remote control, make sure that it is within range of the receiver and press button **1** twice.
 - » LED **2** starts flashing and then goes out after a few seconds.
 - » The remote control is again ready for use.

Riding

Safety instructions	70
Comply with checklist.....	73
Starting	73
Running in	76
Speed	77
Off-roading	78
Brakes	79
Parking your motorcycle	80
Refuelling	80
Secure motorcycle for transporta- tion	82

Safety instructions

Rider's equipment

The following clothing will protect you for every journey:

- Helmet
- Motorcycling jacket and trousers
- Gloves
- Boots

This applies even to short journeys, and to every season of the year. Your authorised BMW Motorrad dealer will be glad to advise you on the correct clothing for every purpose.

Restricted angle of heel

- with lowered suspension^{OE}

A motorcycle with lowered suspension has less ground clearance and cannot corner at angles of heel as extreme as those achievable by a counterpart motorcycle with

standard-height suspension (see the section entitled "Technical data").



WARNING

When a motorcycle with lowered suspension is cornering, certain components can come into contact with the surface at a bank angle less than that to which the rider is accustomed.

Risk of falling

- Carefully try out the limits of the motorcycle's bank angle and adapt your style of riding accordingly.◀

Test your motorcycle's angle of heel in situations that do not involve risk. When riding over kerbs and similar obstacles, bear in mind that your motorcycle's ground clearance is limited.

Lowering the motorcycle's suspension shortens suspension travel. Ride comfort might be restricted as a result. Be sure to adjust spring preload accordingly, particularly for riding two-up.

Load correctly



WARNING

Handling adversely affected by overloading and imbalanced loads.

Risk of falling

- Do not exceed the permissible gross weight and be sure to comply with the instructions on loading.◀
- Adjusting spring preload setting and damping to the total weight.
- with cases^{OA}
- Ensure that the case volumes on the left and right are equal.◀

- with cases^{OA}
or
 - with aluminium cases^{OA}
 - Make sure that the weight is uniformly distributed between right and left.
 - Pack heavy items at the bottom of the cases and toward the inboard side.
 - Note the maximum permissible payload and the speed limit for riding with cases fitted, as stated on the label inside the case (see also the section entitled "Accessories").<
- with topcase^{OA}
or
 - with aluminium topcase^{OA}
 - Note the maximum permissible payload and the speed limit for riding with topcase fitted, as stated on the label inside the case (see also the section entitled "Accessories").<

- with tank rucksack^{OA}
- Note the maximum permissible payload of the tank rucksack (see also the section entitled "Accessories").

 Payload of tank bag
max 5 kg<

- with rear softbag^{OA}
- Note the maximum permissible payload of the rear softbag (see also the section entitled "Accessories").

 Payload of rear softbag
max 1.5 kg<

Speed

If you ride at high speed, always bear in mind that various boundary conditions can adversely af-

fect the handling of your motorcycle, e.g.:

- Spring-strut and shock-absorber system not set up correctly
- Imbalanced load
- Loose clothing
- Insufficient tyre pressure
- Poor tyre tread
- Added luggage systems such as cases, topcase and tank rucksack.

Maximum speed with knobbly tyres or winter tyres

 **DANGER**

Top speed of the motorcycle higher than the permissible maximum rated speed of the tyres.

Risk of accident due to tyre damage at high speed.

- Comply with the tyre-specific speed restrictions.◀

Always bear the maximum permissible speed of the tyres in mind when riding a motorcycle fitted with knobby tyres or winter tyres.

Affix a label stating the maximum permissible speed to the instrument panel in the rider's field of vision.

Risk of poisoning

Exhaust fumes contain carbon monoxide, which is colourless and odourless but highly toxic.



WARNING

Exhaust gases adversely affecting health.

Risk of asphyxiation

- Do not inhale exhaust fumes.
- Do not run the engine in an enclosed space.◀

Risk of burn injury



CAUTION

Engine and exhaust system become very hot when the vehicle is in use.

Risk of burn injury

- When you park the vehicle make sure that no-one and no objects can come into contact with the hot engine and exhaust system.◀

Catalytic converter

If misfiring causes unburned fuel to enter the catalytic converter, there is a danger of overheating and damage.

The following guidelines must be observed:

- Do not run the fuel tank dry
- Do not attempt to start or run the engine with a spark-plug cap disconnected

- Stop the engine immediately if it misfires
- Use only unleaded fuel
- Comply with all specified maintenance intervals.



ATTENTION

Unburned fuel in catalytic converter.

Damage to catalytic converter.

- Note the points listed for protection of the catalytic converter.◀

Risk of overheating



ATTENTION

Engine running for prolonged period with vehicle at standstill.

Overheating due to insufficient cooling. In extreme cases, the motorcycle could catch fire.

- Do not allow the engine to idle unnecessarily.
- Ride away immediately after starting the engine.◀

Tampering



ATTENTION

Tampering with the motorcycle (e.g. engine management ECU, throttle valves, clutch).

Damage to the affected parts, failure of safety-relevant functions. Damage due to tampering is not covered by the warranty.

- Do not tamper with the vehicle in any way that could result in tuned performance.◀

Comply with checklist

- At regular intervals, use the checklist below to check your motorcycle.

Always before riding off:

- Operation of the brake system
- Operation of the lights and signalling equipment
- Checking clutch function (▣▣▣ 114).
- Check the tyre tread depth (▣▣▣ 115).
- Cases correctly installed and luggage secured

Every 3rd refuelling stop:

- without Electronic Suspension Adjustment (ESA)^{OE}
 - Adjust spring preload for rear wheel (▣▣▣ 50).
 - Adjust the damping for rear wheel (▣▣▣ 51).◀
- with Electronic Suspension Adjustment (ESA)^{OE}
 - Adjust the chassis and suspension (▣▣▣ 53).◀
 - Check engine oil level (▣▣▣ 107).

- Check front brake pad thickness (▣▣▣ 109).
- Check rear brake pad thickness (▣▣▣ 110).
- Check brake-fluid level, front brakes (▣▣▣ 111).
- Check the brake-fluid level, rear brakes (▣▣▣ 112).
- Checking coolant level (▣▣▣ 113).
- Lubricate the chain (▣▣▣ 116).
- Check chain sag (▣▣▣ 116).

Starting

Start engine



ATTENTION

Sufficient gearbox lubrication only with the engine is running.

Gearbox damage

- Do not allow the motorcycle to roll for a lengthy period of time or push it a long distance with the engine switched off.◀

- Switch on the ignition.
- » Pre-ride check is performed (▣▣▣ 74)
- » ABS self-diagnosis is in progress. (▣▣▣ 75)
- with Automatic Stability Control (ASC)^{OE}
- » ASC self-diagnosis is performed. (▣▣▣ 75)◀
- Select neutral or, if a gear is engaged, pull the clutch lever.



NOTICE

You cannot start the motorcycle with the side stand extended and a gear engaged. The engine will switch itself off if you start it with the gearbox in neutral and then engage a gear before retracting the side stand.◀

- When starting a cold engine at low ambient temperatures: disengage the clutch and turn

the twistgrip slightly to open the throttle.



- Press starter button **1**.



NOTICE

The start attempt is automatically interrupted if battery voltage is too low. Recharge the battery before you start the engine, or use jump leads and a donor battery to start.

See the subsection on jump starting in "Maintenance" for more details.◀

- » The engine starts.

- » If the engine refuses to start, consult the troubleshooting chart in the section entitled "Technical data" (▣▣▣ 146)

Pre-ride check

The instrument panel runs a test of the instruments and the telltale and warning lights when the ignition is switched on: this is the so-called "Pre-Ride-Check". The test is aborted if you start the engine before it completes.

Phase 1

The rev. counter and speedometer needles both swing to the limit values on their scales. At the same time, all the warning lights and telltale lights are switched on in succession.

Phase 2

The general warning light changes from yellow to red.

Phase 3

The rev. counter and speedometer needles both swing to the starting position on their scales. At the same time, all the warning lights and telltale lights switched on in the initial phase are switched off in reverse sequence.

If a needle did not move or if a warning light or telltale light did not show:

- Have the fault rectified as quickly as possible by a specialist workshop, preferably an authorised BMW Motorrad dealer.

ABS self-diagnosis

BMW Motorrad ABS performs self-diagnosis to ensure its operability. Self-diagnosis is performed automatically when you switch on the ignition. The motorcycle has to move forward a

few metres for the wheel-speed sensors to be tested.

Phase 1

Test of the diagnosable system components with the vehicle at a standstill.



ABS telltale and warning light flashes.

Phase 2

Test of the wheel-speed sensors as the vehicle pulls away from rest.



ABS telltale and warning light flashes.

ABS self-diagnosis completed

The ABS telltale and warning light goes out.

- Check all the telltale and warning lights.

After the ABS self-diagnosis completes, an indicator showing an ABS fault will appear.

- You can continue to ride. Bear in mind that the ABS function is not available.
- Have the fault rectified as quickly as possible by a specialist workshop, preferably an authorised BMW Motorrad dealer.

ASC self-diagnosis

– with Automatic Stability Control (ASC)^{OE}

BMW Motorrad ASC performs self-diagnosis to ensure its operability. Self-diagnosis is performed automatically when you switch on the ignition.

Phase 1

- » Test of the diagnosis-compatible system components with the vehicle at a standstill.



ASC telltale and warning light slow-flashes.

Phase 2

» Test of the diagnosis-compatible system components while the motorcycle is on the move (speed at least 5 km/h).



ASC telltale and warning light slow-flashes.

ASC self-diagnosis completed

» The ASC telltale and warning light goes out.

If an indicator showing an ASC fault appears when ASC self-diagnosis completes:

- You can continue to ride. Bear in mind that the ASC function is not available.
- Have the fault rectified as quickly as possible by a specialist workshop, preferably

an authorised BMW Motorrad dealer.

Running in

Engine

- Until the first running-in check, vary the throttle opening and engine-speed range frequently; avoid riding at constant engine rpm for prolonged periods.
- Try to do most of your riding during this initial period on twisting, fairly hilly roads, avoiding high-speed main roads and highways if possible.
- Comply with the rpm limits for running in.



Running-in speed

<5000 min⁻¹

- Do not omit the first running-in check after 500 - 1200 km.

Brake pads

New brake pads have to bed down before they can achieve their optimum friction levels. You can compensate for this initial reduction in braking efficiency by exerting greater pressure on the levers.



WARNING

New brake pads.

Longer stopping distance. Risk of accident.

- Apply the brakes in good time. ◀

Tyres

New tyres have a smooth surface. This must be roughened by riding in a restrained manner at various heel angles until the tyres are run in. This running in procedure is essential if the tyres are to achieve maximum grip.

WARNING

New tyres losing grip on wet roads and at extreme bank angles.

Risk of accident

- Ride carefully and avoid extremely sharp inclines. ◀

Speed

– with on-board computer^{OE}

Redline warning



The redline warning indicates that engine revolutions have reached the rev. counter's red segment. The anti-theft alarm telltale light **1** flashes red to indicate that the engine is redlining.

The signal remains active until you shift up or reduce engine speed. You can activate or deactivate the redline warning.

Activating redline warning

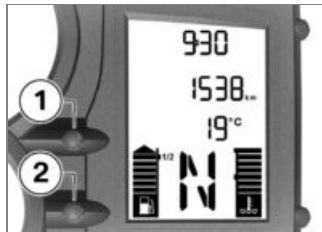

- Press button **1** and button **2** at the same time and hold them down until the reading changes.
 - » FLASH (redline warning) appears, along with ON or OFF.
- Repeatedly press button **1** until the reading shows the mode you want.
 - » ON: Redline warning activated.
 - » OFF: Redline warning deactivated.
- To save the setting, press button **1** and button **2** at the same time and hold

them down until the reading changes.

Off-roading

After off-roading

BMW Motorrad recommends checking the following after riding the motorcycle off-road:

Tyre pressure



WARNING

Riding on surfaced roads with tyre pressures lowered for off-roading.

Risk of accident due to impaired handling characteristics.

- Always check that the tyre pressures are correct. ◀

Brakes



WARNING

Riding on unsurfaced roads or dirty road surfaces.

Delayed braking effect due to dirty brake discs and brake pads.

- Apply the brakes in good time until the brakes have been cleaned. ◀



ATTENTION

Riding on unsurfaced roads or dirty road surfaces.

Increased brake-pad wear.

- Check the thickness of the brake pads more frequently and replace the brake pads in good time. ◀

Spring preload and shock-absorber settings



WARNING

Changed values for spring preload and spring-strut damping for riding off-road.

Impaired handling characteristics on surfaced roads.

- If you have been off-roading, be sure to correct spring preload and spring-strut damping characteristics before you return to surfaced roads. ◀

Rims

BMW Motorrad recommends checking the rims for damage after off-roading.

Air filter element



ATTENTION

Dirty air-filter element.

Engine damage

- If you ride in dusty terrain check the air filter element for clogging at shorter intervals; clean or replace as necessary. ◀

Operation in very dusty conditions (desert, steppes, or the like) necessitates the use of air filter elements specially designed for conditions of this nature.

Brakes

How can stopping distance be minimised?

Each time the brakes are applied, a load distribution shift takes place with the load shifting forward from the rear to the front wheel. The sharper the vehicle decelerates, the more load is shifted to the front wheel. The higher the wheel load, the more braking force can be transmitted without the wheel locking.

To optimise stopping distance, apply the front brakes rapidly and keep on increasing the force you apply to the brake lever. This makes the best possible use of the dynamic increase in load at the front wheel. Remember to pull the clutch at the same time. In the "panic braking situations" that are trained so frequently, braking force is applied as rapidly as possible and with the

rider's full force applied to the brake levers; under these circumstances, the dynamic shift in load distribution cannot keep pace with the increase in deceleration and the tyres cannot transmit the full braking force to the surface of the road. Under these circumstances the front wheel can lock up.

BMW Motorrad ABS prevents the front wheel from locking up.

Descending mountain passes



Braking only with the rear brake on mountain descents.

Brake fade. Destruction of the brakes due to overheating.

- Use both front and rear brakes, and make use of the engine's braking effect as well. ◀

Wet and dirty brakes

Wetness and dirt on the brake discs and the brake pads diminish braking efficiency.

Delayed braking action or poor braking efficiency must be reckoned with in the following situations:

- Riding in the rain or through puddles of water
- After the vehicle has been washed
- Riding on salted or gritted roads
- After work has been carried on the brakes, due to traces of oil or grease
- Riding on dirt-covered surfaces or off-road.



Moisture and dirt.

Diminished braking effect.

- Apply the brakes lightly while riding to remove wetness and

dirt, or dismount and clean the brakes.

- Think ahead and brake in good time until full braking efficiency is restored.◀

Parking your motorcycle

Side stand

- Switch off the engine.



ATTENTION

Poor ground underneath the stand.

Risk of damage to parts if vehicle topples.

- Always check that the ground under the stand is level and firm.◀



ATTENTION

Additional weight placing strain on the side stand.

Risk of damage to parts if vehicle topples.

- Do not sit or lean on the vehicle while it is propped on the side stand.◀
- Extend the side stand and prop the motorcycle on the stand.
- If the camber of the roadway permits, turn the handlebars all the way to the left.
- On a gradient, the motorcycle should always face uphill; select 1st gear.

Centre stand

– with centre stand^{OE}

- Switch off the engine.



ATTENTION

Poor ground underneath the stand.

Risk of damage to parts if vehicle topples.

- Always check that the ground under the stand is level and firm.◀



ATTENTION

Centre stand retracts due to severe movements.

Risk of damage to parts if vehicle topples.

- Do not lean or sit on the vehicle with the centre stand extended.◀
- Extend the centre stand and lift the motorcycle onto the stand.
- On a gradient, the motorcycle should always face uphill; select 1st gear.

Refuelling

Fuel grade

For optimum fuel consumption, fuel should be sulphur-free or with the lowest sulphur content possible.



ATTENTION

Leaded fuel.

Damage to catalytic converter.

- Do not attempt to run the vehicle on leaded fuel or fuel with metallic additives, e.g. manganese or iron. ◀
- You can run the engine on fuel with a maximum ethanol content of 10 %, i.e. E10.



Recommended fuel grade

Super unleaded (max. 10 % ethanol, E10)
95 ROZ/RON
89 AKI

– with regular unleaded^{OE}



Recommended fuel grade

Regular unleaded (slight power- and consumption-related restrictions) (max. 10 % ethanol, E10)
91 ROZ/RON
87 AKI◀

Refuelling



WARNING

Fuel is highly flammable.

Risk of fire and explosion.

- Do not smoke. Never bring a naked flame near the fuel tank. ◀



WARNING

Escape of fuel due to heat-induced expansion if fuel tank is overfilled.

Risk of falling

- Do not overfill the fuel tank. ◀



ATTENTION

Fuel attacks plastic surfaces.

Surfaces become unsightly or dull.

- Clean plastic parts immediately after contact with fuel. ◀
- Make sure the ground is level and firm and place the motorcycle on its side stand.



NOTICE

The volume of the tank can be utilised to the full only when the motorcycle is propped on its side stand. ◀

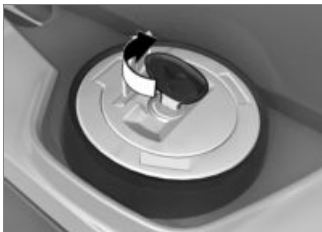

- Open the protective cap.
- Use the ignition key to unlock the fuel filler cap and pop the cap open.



- Do not fill the tank past the bottom edge of the filler neck.

**NOTICE**

When refuelling after running on reserve, make sure that you top up the tank to a level above reserve, as otherwise the new level will not be registered and the fuel warning light indicating that the level is down to reserve will not be switched off. ◀

**NOTICE**

The "usable fuel capacity" specified in the technical data is the quantity that the fuel tank could hold if it had been run dry and the engine had cut out due to a lack of fuel. ◀



Usable fuel capacity

approx. 16 l



Reserve fuel

min 2.7 l

- Press the fuel tank cap down firmly to close.
- Remove the key and close the protective cap.

Secure motorcycle for transportation

- Make sure that all components that might come into contact with straps used to secure the motorcycle are adequately protected against scratching. Use adhesive tape or soft cloths, for example, for this purpose.



ATTENTION

Vehicle topples to side when being lifted on to stand.

Risk of damage to parts if vehicle topples.

- Secure the vehicle to prevent it toppling, preferably with the assistance of a second person.◀
- Push the motorcycle onto the transportation flat and hold it in position: do not place it on the side stand or centre stand.

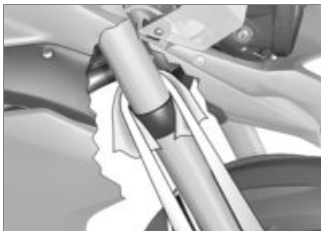

ATTENTION

Trapping of components.

Component damage

- Do not trap components such as brake lines or cable legs.◀
- At the front, secure the straps to the bottom fork bridge on both sides and tighten the straps.



- At the rear, secure the straps to the rear frame on both sides and tighten the straps.
- Tighten all the straps uniformly; the vehicle's suspension should be compressed as tightly as possible front and rear.

Engineering details

Riding mode	86
Brake system with BMW Motorrad ABS	87
Electronic engine management with BMW Motorrad ASC.....	89

Riding mode

- with off-road mode ABS and ASC^{OE}

Selection

In order to adjust the motorcycle to the road condition, two riding modes can be selected:

- ROAD: On-road riding
- ENDURO: Off-road riding

For each of the two riding modes aligned settings for the ABS and ASC systems are available.

ABS and/or ASC can be switched off in each mode: the explanations below invariably apply to the behaviour of the motorcycle with these systems active.

ABS

- The rear wheel lift assistant is active in both modes.

- In the ROAD mode ABS has been adjusted to on-road riding.
- In ENDURO mode ABS has been adjusted to off-road riding using massive-bar tyres.

ASC

- The front wheel lift assistant is active in both modes.
- In ROAD mode the ASC is configured for on-road riding.
- In ENDURO mode the ASC is configured for off-road riding.

Mode changes

A changeover of the ABS and ASC functions while riding is possible only in certain operating states:

- No drive torque at the rear wheel
- No brake pressure in the brake system.

In order to achieve this state:

- The throttle twistgrip must be in the fully closed position,
- The brake levers must be in the released positions,
- The clutch lever must be pulled and the clutch disengaged

or

- The motorcycle must be at a standstill with the ignition switched on.

The desired riding mode is initially preselected. The mode change does not take place until the systems in question are all in the appropriate state.

Brake system with BMW Motorrad ABS

How does ABS work?

The amount of braking force that can be transferred to the road depends on factors that include the coefficient of friction of the road surface. Loose stones, ice and snow or a wet road all have much lower coefficients of friction than a clean, dry asphalt surface. The lower the coefficient of friction, the longer the braking distance.

If the rider increases braking pressure to the extent that braking force exceeds the maximum transferable limit, the wheels start to lock and the motorcycle loses its directional stability; a fall is imminent. Before this situation can occur, ABS intervenes and adapts braking pressure to the maximum transferrable braking force, so the wheels continue

to turn and directional stability is maintained irrespective of the condition of the road surface.

What are the effects of surface irregularities?

Humps and surface irregularities can cause the wheels to lose contact temporarily with the road surface; if this happens the braking force that can be transmitted to the road can drop to zero. If the brakes are applied under these circumstances the ABS has to reduce braking force to ensure that directional stability is maintained when the wheels regain contact with the road surface. At this instant the BMW Motorrad ABS must assume an extremely low coefficient of friction, so that the wheels will continue to rotate under all imaginable circumstances, because this is the precondition for ensuring directional stability.

As soon as it registers the actual circumstances, the system reacts instantly and adjusts braking force accordingly to achieve optimum braking.

Rear wheel lift

Under very severe and sudden deceleration, however, under certain circumstances it is possible that the BMW Motorrad ABS will be unable to prevent the rear wheel from lifting clear of the ground. If this happens the outcome can be a highside situation in which the motorcycle can flip over.

WARNING

Rear wheel lift due to severe braking.

Risk of falling

- When you brake sharply, bear in mind that ABS control cannot always be relied on to pre-

vent the rear wheel from lifting clear of the ground.◀

What is the design baseline for BMW Motorrad ABS?

Within the limits imposed by physics, BMW Motorrad ABS ensures directional stability on any surface. The system is not optimised for special requirements that apply under extreme competitive situations off-road or on the track.

Special situations

The speeds of the front and rear wheels are compared as one means of detecting a wheel's incipient tendency to lock. If the system registers implausible values for a lengthy period the ABS function is deactivated for safety reasons and an ABS fault message is issued. Self-dia-

gnosis has to complete before fault messages can be issued. In addition to problems with the BMW Motorrad ABS, exceptional riding conditions can lead to a fault message being issued.

Exceptional riding conditions:

- Riding for a lengthy period with the front wheel lifted off the ground (wheelie).
- Rear wheel rotating with the vehicle held stationary by applying the front brake (burn-out).
- Heating up with the motorcycle on the centre stand or an auxiliary stand, engine idling or with a gear engaged.
- Rear wheel locked for a lengthy period, for example while descending off-road.

If a fault message should be triggered due to one of the above-described driving

conditions, the ABS function can be re-activated by switching the ignition off and then on again.

What significance devolves on regular maintenance?



WARNING

Brake system not regularly serviced.

Risk of accident

- In order to ensure that the BMW Motorrad ABS is always maintained in optimum condition, it is essential for you to comply strictly with the specified inspection intervals.◀

Reserves for safety

The potentially shorter braking distances which BMW Motorrad ABS permits must not be used as an excuse for careless riding. ABS is primarily a means of en-

sureing a safety margin in genuine emergencies.

Take care when cornering! When you apply the brakes on a corner, the motorcycle's weight and momentum take over and even BMW Motorrad ABS is unable to counteract their effects.

Electronic engine management with BMW Motorrad ASC

– with Automatic Stability Control (ASC)^{OE}

How does ASC work?

The BMW Motorrad ASC system compares the speed of rotation of the front wheel and the rear wheel. The differential is used to compute slip as a measure of the reserves of stability available at the rear wheel. If slip exceeds a certain limit the engine control in-

tervenes, adapting engine torque accordingly.

What is the design baseline for BMW Motorrad ASC?

BMW Motorrad ASC is designed as an assistant system for the rider and for use on public roads. The extent to which the rider affects the ASC can be considerable (weight shifts when cornering, items of luggage loose on the motorcycle), especially when style of riding takes rider and machine close to the limits imposed by physics.

The system is not optimised for special requirements that apply under extreme competitive situations off-road or on the track. You have the option of deactivating the BMW Motorrad ASC system for these circumstances.

WARNING

Risky riding.

Risk of accident despite ASC.

- Invariably, it remains the rider's responsibility to adapt riding style to riding conditions.
- Do not take risks that would negate the additional safety offered by this system. ◀

Special situations

In accordance with the laws of physics, the ability to accelerate is restricted more and more as the angle of heel increases. Consequently, there can be a perceptible lag in acceleration out of very tight bends.

The speeds of the front and rear wheels are compared as one means of detecting the rear wheel's incipient tendency to spin or slip sideways. If the system registers implausible values

for a lengthy period the ASC function is deactivated for safety reasons and an ASC fault message is issued. Self-diagnosis has to complete before fault messages can be issued.

The BMW Motorrad ASC can shut down automatically under the exceptional riding conditions outlined below.

Exceptional riding conditions:

- Riding for a lengthy period with the rear wheel lifted off the ground (wheelie) with ASC deactivated
- Rear wheel rotating with the vehicle held stationary by applying the front brake (burn-out)
- Heating up with the motorcycle on the centre stand or an auxiliary stand, engine idling or with a gear engaged

Accelerating the motorcycle to a speed in excess of 5 km/h after switching the ignition off and then on again reactivates the ASC.

If the front wheel lifts clear of the ground under severe acceleration, the ASC reduces engine torque until the front wheel regains contact with the ground. Under these circumstances, BMW Motorrad recommends rolling the throttle slightly closed so as to restore stability with the least possible delay.

When riding on a slippery surface, never snap the throttle twistgrip fully closed without pulling the clutch at the same time. Engine braking torque can cause the rear wheel to lock, with a corresponding loss of stability. The BMW Motorrad ASC is un-

able to control a situation of this nature.

Accessories

General instructions.....	92
Power sockets	92
Luggage	93
Auxiliary headlights.....	93
Cases.....	94
Topcase	97
Aluminium case	100
Aluminium topcase	102

General instructions

BMW Motorrad recommends the use of parts and accessories for your motorcycle that are approved by BMW for this purpose. Your BMW Motorrad authorised dealer will offer you professional advice in your selection of original BMW parts and accessories and other products approved by BMW.

These parts and products have been tested by BMW for safety, function and suitability. BMW accepts product liability for them. BMW is unable to accept any liability whatsoever for parts and accessories which it has not approved.

Also bear in mind the information on the effect of wheel size on running-gear control systems (►► 118).



CAUTION

Use of other-make products.

Safety risk

- BMW Motorrad cannot examine or test each product of outside origin to ensure that it can be used on or in connection with BMW vehicles without constituting a safety hazard. Country-specific official authorisation does not suffice as assurance. Tests conducted by these instances cannot make provision for all operating conditions experienced by BMW vehicles and, consequently, they are not sufficient in some circumstances.
- Use only parts and accessories approved by BMW for your vehicle. ◀

Whenever you are planning modifications, comply with all the legal requirements. Make

sure that the vehicle does not infringe the national road-vehicle construction and use regulations applicable in your country.

Power sockets

Notes on use of power sockets:

Automatic shutdown

Power sockets are shut down automatically under the following circumstances:

- If battery charge state is too low to maintain the motorcycle's start capability
- If maximum load capability as stated in the technical data is exceeded
- When the engine is being cranked on the starter.

Operating electrical accessories

You can start using electrical accessories connected to the motorcycle's sockets only when

the ignition is switched on. The accessory remains operational if the ignition is subsequently switched off. Approximately 15 minutes after ignition is turned off, power sockets are switched off to lessen the burden on the on-board electrical system. Low-wattage electrical accessories might not be recognised by the vehicle's electronics. In such cases, power sockets are switched off very shortly after the ignition is turned off.

Cable routing

The cables from the power sockets to the auxiliary devices must be routed in such a way that they:

- Do not impede the rider,
- Do not restrict the steering angle or obstruct handling,
- Cannot be trapped.

Luggage

Lashing luggage

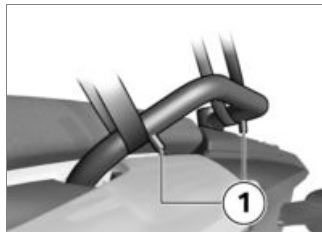

- Loop the luggage straps over the bar between the motorcycle and stops **1**.



- Position luggage strap **2** as shown here with a stuffbag as example.
- Check that the luggage is secure.

Auxiliary headlights

– with LED auxiliary headlights^{OA}

Operating auxiliary headlights



NOTICE

The auxiliary headlights have approval as fog lights and their use is permissible in bad weather

conditions only. Always comply with the road traffic regulations in force in the country in which the vehicle is used.◀

- Start the engine.



- Press button **1** to switch on the auxiliary headlights.



The telltale light for the auxiliary headlights is on.

- » If the auxiliary headlights were turned on before the motor was switched off, they will be automatically switched back off.

- Press button **1** again to switch off the auxiliary headlights.

Cases

Opening cases

– with cases^{OA}



- Turn key **1** in the case lock to right angles with the forward direction of travel.
- Keep the yellow latch **2** held and fold out the carry handle **3**.

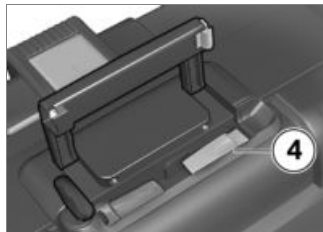

- Push yellow button **4** down and at the same time open the lid of the case.

Close cases

– with cases^{OA}

- Turn the lock with the key until it is at right angles to the forward direction of travel.
- Close the case lid.
- » The lid engages with an audible click.

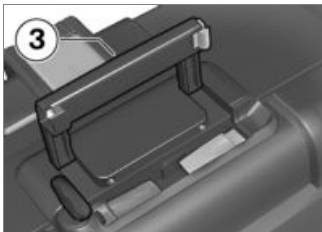

ATTENTION

Closure of carrying handle with case lock latched.

Damage to locking tab.

- Make sure that the case lock is at right angles to the forward direction of travel when you close the carry handle. ◀
- Close carry handle **3**.
- Turn the key in the case lock in line with the forward direction of travel and remove the key from the lock.

Adjusting case volume

– with cases^{OA}

- Open the case and remove all its contents.



- Engage pivot lever **1** at the top limit position to set the case to minimum volume.
- Engage pivot lever **1** at the bottom limit position to set the case to maximum volume.
- Close the case.

Removing cases

– with cases^{OA}



- Turn key **1** in the case lock to right angles to the forward direction of travel.
- Keep the yellow latch **2** held and fold out the carry handle **3**.

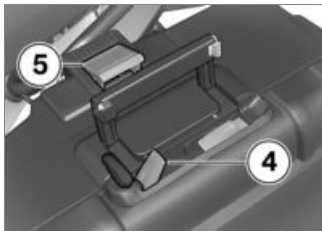

- Pull red release lever **4** up.
» Latching flap **5** pops up.
- Fully open the latching flap.
- Take a firm grip of the handle and lift the case out of the holder.

Installing cases

– with cases^{OA}

- Turn the lock with the key until it is at right angles to the forward direction of travel.

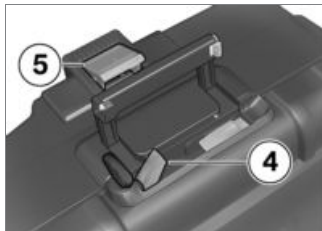

- Fully open latching flap **5**, if necessary pulling up red release lever **4**.

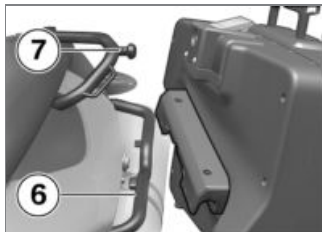

- Position the case in case carrier **6**, then pivot it until it is seated at mount **7**.

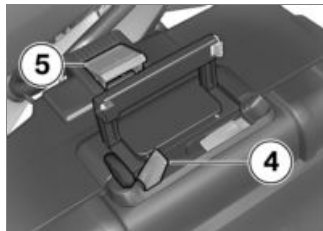

- Push latching flap **5** down as far as it will go and hold it in this position.
- Push red release lever **4** down.
» Latching flap **5** engages.



ATTENTION

Closure of carrying handle with case lock latched.

Damage to locking tab.

- Make sure that the case lock is at right angles to the forward direction of travel when you close the carry handle.◀
- Close the carry handle.

- Turn the key parallel with the direction of travel and remove.

Maximum payload and maximum permissible speed

Note the maximum permissible payload and the speed limit for riding with cases fitted, as stated on the label inside the case.

Contact your authorised BMW Motorrad dealer if you cannot find your combination of vehicle and cases on the label.

The values for the combination described here are as follows:



Maximum permissible speed for riding with cases fitted to the motorcycle

max 180 km/h



Payload per case

max 10 kg

Topcase

Opening topcase

– with topcase^{OA}



- Turn key **1** in the topcase lock to the vertical position.
- Keep the yellow latch **2** held and fold out the carry handle **3**.



- Push yellow button **4** forward and at the same time push the topcase lid up.

Closing topcase

– with topcase^{OA}

- Turn key in the topcase lock to the vertical position.



- Press down firmly on the topcase lid to close.



ATTENTION

Closure of carrying handle with case lock latched.

Damage to locking tab.

- Make sure that the topcase lock is vertical when you close the carry handle. ◀
- Close carry handle **3**.
- » The handle engages with an audible click.
- Turn the key in the topcase lock to the horizontal position

and remove the key from the lock.

Adjusting topcase volume

– with topcase^{OA}

- Open the topcase and remove all its contents.



- Engage pivot lever **1** at the front limit position to set the case to maximum volume.
- Engage pivot lever **1** at the rear limit position to set the case to minimum volume.
- Close the topcase.

Removing the topcase

– with topcase^{OA}



- Turn key **1** in the topcase lock to the vertical position.
- Keep the yellow latch **2** held and fold out the carry handle **3**.



- Pull back red release lever **4**.
» Latching flap **5** pops up.
- Fully open latching flap **5**.
- Take a firm grip of the handle and lift the topcase out of the holder.

Installing topcase

– with topcase^{OA}

- Turn key in the topcase lock to the vertical position.



- Fully open latching flap **5**, if necessary pulling red release lever **4** to the rear.

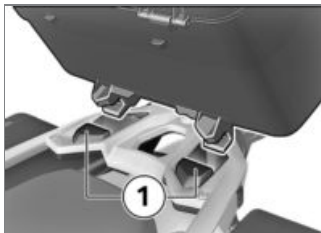

- Engage the topcase in front holders **1** of the topcase carrier plate.

- Press the topcase onto the topcase carrier plate at the rear.



- Push latching flap **5** fully closed and hold it in this position.
- Push red release lever **4** forward.
» The latching flap engages.



ATTENTION

Closure of carrying handle with case lock latched.

Damage to locking tab.



- Make sure that the topcase lock is vertical when you close the carry handle.◀
- Close the carry handle.
- Turn the key to the horizontal position and remove.

Maximum payload and maximum permissible speed

Note the maximum permissible payload and the speed limit for riding with topcase fitted, as stated on the label inside the topcase.

Contact your authorised BMW Motorrad dealer if you cannot find your combination of vehicle and topcase on the label.

The values for the combination described here are as follows:

	Maximum permissible speed for riding with topcase fitted to the vehicle
max 180 km/h	
	Payload of topcase
max 5 kg	

Aluminium case

Opening cases

– with aluminium cases^{OA}

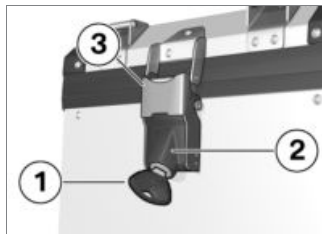

- Turn key **1** counter-clockwise.



NOTICE

The case lid can be opened at either the left or the right latch.◀

- Push lock housing **2** upwards in order to release the catch **3**.
- Pull the latch **3** to one side and open the lid.

Closing cases

– with aluminium cases^{OA}

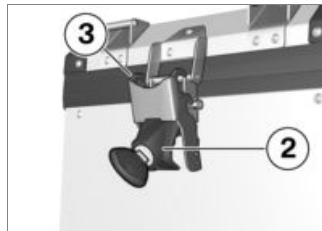

- Close the case lid.
- Set the latch **3** on the lid.

- Push lock housing **2** down, making sure that the latch toggle grips firmly in the lid.
- To secure the lock, turn the key clockwise and remove.

Removing case lid

– with aluminium cases^{OA}

- Open one latch of the case lid.



- Disengage retainer **1**.
- Close the case lid.
- Open the second catch of the case lid.
- Remove the case lid.

Installing case lid

– with aluminium cases^{OA}

- Place the case lid on the case.
- Close one latch of the case lid.
- Open the case lid at the fastened side.



- Engage retainer **1**.
- Close the case lid.
- Close the second latch of the case lid.

Removing cases

– with aluminium cases^{OA}

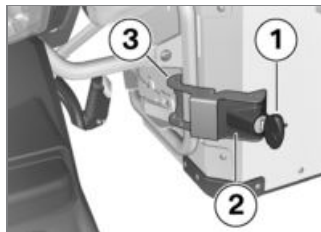

- Turn key **1** counter-clockwise.
- Push lock housing **2** to one side in order to release the catch **3**.
- Push the latch **3** to one side while holding the case.

CAUTION

Heat build-up of the left case and case carrier on long rides.

Risk of burn injury

- Allow the case and the case carrier to cool down before removing the case.◀
- Pull the case back as far as it will go and then out to remove.

Installing cases

– with aluminium cases^{OA}

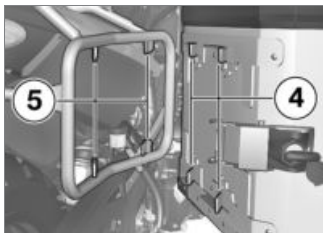

- Set the case on the case carrier and push it forward in such a way that mounts on case carrier **5** and on case **4** engage each other.

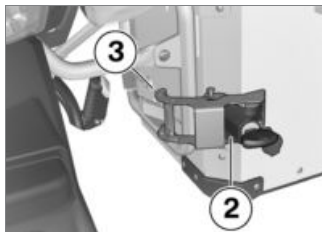



- Place the latch **3** on the case carrier while holding the case.
- Push lock housing **2** to the side, making sure that the latch toggle grips firmly on the carrier.
- Turn the key clockwise and remove.

Maximum payload and maximum permissible speed

Note the maximum permissible payload and the speed limit for riding with cases fitted, as stated on the label inside the case.

Contact your authorised BMW Motorrad dealer if you cannot find your combination of vehicle and cases on the label.

The values for the combination described here are as follows:

	Maximum permissible speed for riding with cases fitted to the motorcycle
max 180 km/h	
	Payload per case
max 10 kg	

Aluminium topcase

Topcase and off-roading

– with aluminium topcase^{OA}

It is advisable to either remove the topcase or fit the backrest cushion available as an optional accessory if you intend off-roading.

Opening topcase

– with aluminium topcase^{OA}

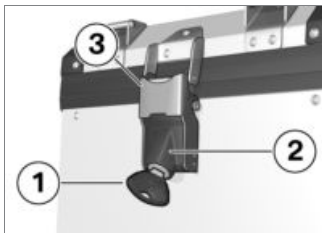

- Turn key **1** counter-clockwise.
- Push lock housing **2** upwards in order to release the catch **3**.
- Pull the latch **3** backwards and open the lid.

Closing topcase

– with aluminium topcase^{OA}



- Close the topcase lid.
- Set the latch **3** on the lid.
- Push lock housing **2** down, making sure that the latch toggle grips firmly in the lid.
- To secure the lock, turn the key clockwise and remove.

Removing topcase

– with aluminium topcase^{OA}

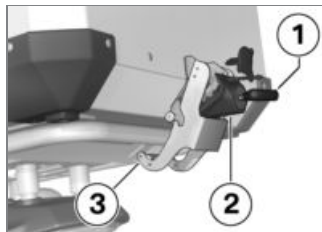

- Turn key **1** counter-clockwise.
- Push lock housing **2** downwards in order to release the catch **3**.
- Pull the latch **3** backwards.
- Pull the topcase to the rear and then lift it up to remove.

Installing topcase

– with aluminium topcase^{OA}

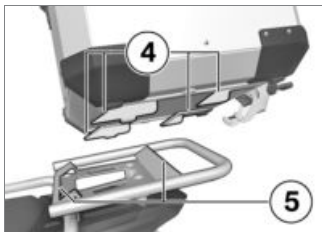

- Set the topcase on the topcase rack and push it forward in such a way that mounts on topcase rack **5** and on topcase **4** engage each other.

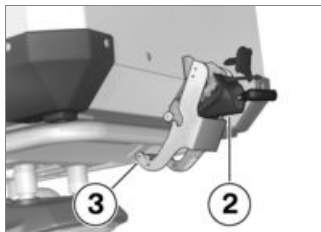



- Set the latch **3** on the topcase holders.
- Push lock housing **2** up, making sure that the latch toggle grips firmly on the carrier.
- To secure the lock, turn the key clockwise and remove.

Maximum payload and maximum permissible speed

Note the maximum permissible payload and the speed limit for riding with topcase fitted, as stated on the label inside the topcase.

Contact your authorised BMW Motorrad dealer if you cannot find your combination of vehicle and topcase on the label. The values for the combination described here are as follows:

	Maximum permissible speed for riding with topcase fitted to the vehicle
max 180 km/h	
	Payload of topcase
max 5 kg	

Maintenance

General instructions.....	106
Toolkit	106
Engine oil	107
Brake system	109
Coolant	113
Clutch	114
Rims and tyres.....	115
Chain	116
Wheels	118
Front-wheel stand	127
Bulbs	128
Body panels	134
Air filter	135
Jump-starting.....	136
Battery.....	137

General instructions

The "Maintenance" chapter describes straightforward procedures for checking and replacing certain wear parts.

Special tightening torques are listed as applicable. The tightening torques for the threaded fasteners on your vehicle are listed in the section entitled "Technical data".

You will find information on more extensive maintenance and repair work in the Repair Manual on DVD for your vehicle, which is available from your authorised BMW Motorrad dealer.

Some of the work calls for special tools and a thorough knowledge of the technology involved. If you are in doubt consult a specialist workshop, preferably your authorised BMW Motorrad dealer.

Toolkit

Standard tool kit

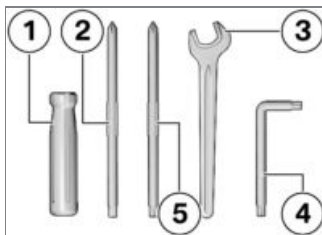

- 1 Screwdriver handle
- 2 Reversible screwdriver blade
With star-head and plain-tip ends
 - Replacing bulbs for front and rear turn indicators (►► 131).
 - Replacing number-plate light bulbs (►► 132).
 - Removing battery (►► 139).

- 3 Open-ended spanner
Width across flats 17
– Adjusting mirror arm (►► 50).
- 4 Torx wrench, T40
– Adjusting headlight beam throw (►► 55).
- 5 Reversible screwdriver blade
Phillips PH1 and Torx T25
– Removing centre trim panel (►► 134).

Service toolkit

- with service toolkit^{OA}

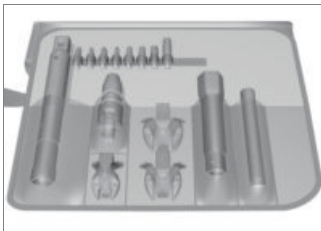

BMW Motorrad has assembled a service toolkit that is ideal for carrying out extended service work (e.g. removing and installing wheels) on this motorcycle. You can obtain the tools set from your authorised BMW Motorrad dealer.

Engine oil

Check engine oil level



ATTENTION

The oil level varies with the temperature of the oil. The higher the temperature, the

higher the level of oil in the sump.

Misinterpretation of the oil level

- Check the oil level only after a lengthy ride or when the engine is at operating temperature.◀
- Wipe the area around the oil filler neck clean.
- Allow the engine to idle until the fan starts up, then allow it to idle one minute longer.
- Switch off the engine.
- Make sure the engine is at operating temperature and hold the motorcycle upright.
 - with centre stand^{OE}
- Check that the engine is at operating temperature, make sure the ground is level and firm and place the motorcycle on its centre stand.<

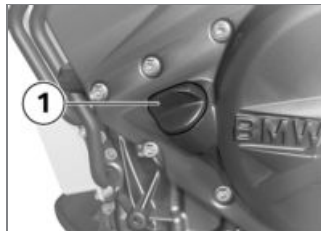

ATTENTION

Vehicle topples to side when being lifted on to stand.

Risk of damage to parts if vehicle topples.

- Secure the vehicle to prevent it toppling, preferably with the assistance of a second person.◀
- Remove oil dipstick **1**.

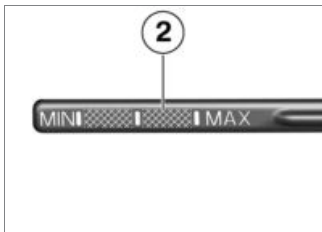

- Use a dry cloth to wipe gauge length **2** clean
- Seat the oil dipstick on the oil filler neck, but do not engage the threads.
- Remove the oil dipstick and check the oil level.

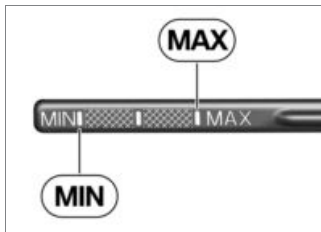

Engine oil, specified level

Between MIN and MAX marks



Engine oil, quantity for topping up

Viscosity class

max 0.4 l (Difference between MIN and MAX)

If the oil level is below the MIN mark:

- Top up the engine oil (➡ 108).

If the oil level is above the MAX mark:

- Have the oil level corrected by a specialist workshop, preferably an authorised BMW Motorrad dealer.
- Install the oil dipstick.

Top up the engine oil

- Make sure the ground is level and firm and place the motorcycle on its stand.
- Wipe the area around the filler neck clean.



- Remove oil dipstick **1**.

ATTENTION

Not enough or too much engine oil.

Engine damage

- Always make sure that the oil level is correct.◀
- Top up the engine oil to the specified level.
- Check engine oil level (▮▮▮▶ 107).
- Install the oil dipstick.

Brake system

Check operation of brakes

- Pull the front brake lever.
 - » The pressure point must be clearly perceptible.
- Press the footbrake lever.
 - » The pressure point must be clearly perceptible.

If pressure points are not clearly perceptible:

ATTENTION

Work on brake system not in compliance with correct procedure.

Risk to operational reliability of the brake system.

- Have all work on the brake system undertaken by trained and qualified specialists.◀
- Have the brakes checked by a specialist workshop, preferably an authorised BMW Motorrad dealer.

Check front brake pad thickness

- Make sure the ground is level and firm and place the motorcycle on its stand.



- Visually inspect the left and right brake pads to ascertain their thickness. Viewing direction: between wheel and front suspension toward brake calipers **1**.

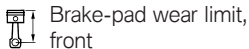
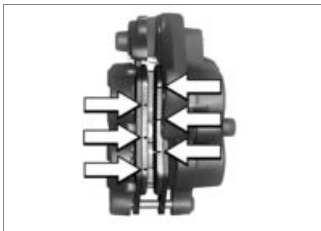

Brake-pad wear limit,
front

min 1.0 mm (Friction pad only, without backing plate. The wear indicators, i.e. the grooves, must be clearly visible.)

If the wear indicating marks are no longer clearly visible:



WARNING

Brake-pad thickness less than permissible minimum.

Diminished braking effect. Damage to the brakes.

- In order to ensure the dependability of the brake system, do not permit the brake pads to wear past the minimum permissible thickness.◀
- Have the brake pads replaced by a specialist workshop, preferably an authorised BMW Motorrad dealer.

Check rear brake pad thickness

- Make sure the ground is level and firm and place the motorcycle on its stand.



- Visually inspect the brake pads to ascertain their thickness. Viewing direction: from the rear toward brake caliper **1**.



Brake-pad wear limit,
rear

min 1.0 mm (Friction pad only, without backing plate.)

If the brake pads are worn:



WARNING

Brake-pad thickness less than permissible minimum.

Diminished braking effect. Damage to the brakes.

- In order to ensure the dependability of the brake system, do not permit the brake pads to wear past the minimum permissible thickness.◀
- Have the brake pads replaced by a specialist workshop, preferably an authorised BMW Motorrad dealer.

Check brake-fluid level, front brakes

- Make sure the ground is level and firm and hold the motorcycle upright.
 - with centre stand^{OE}
- Make sure the ground is level and firm and place the motorcycle on its centre stand.◀
- Move the handlebars to the straight-ahead position.



WARNING

Not enough brake fluid in brake fluid reservoir.

Considerably reduced braking power due to air in the brake system.

- Check the brake-fluid level at regular intervals.◀
- Check the brake fluid level in front reservoir **1**.

NOTICE

Wear of the brake pads causes the brake fluid level in the reservoir to sink.◀



 Brake fluid level, front (visual inspection)

Brake fluid, DOT4

It is impermissible for the brake fluid level to drop below the MIN mark.

If the brake fluid level drops below the permitted level:

- Have the defect rectified as quickly as possible by a specialist workshop, preferably an authorised BMW Motorrad dealer.

Check the brake-fluid level, rear brakes

- Make sure the ground is level and firm and hold the motorcycle upright.
- with centre stand^{OE}
- Make sure the ground is level and firm and place the motorcycle on its centre stand.◀

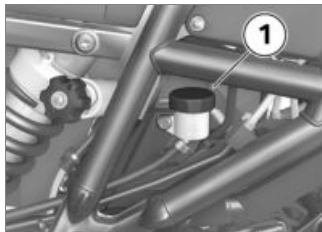

WARNING

Not enough brake fluid in brake fluid reservoir.

Considerably reduced braking power due to air in the brake system.

- Check the brake-fluid level at regular intervals.◀
- Check the brake fluid level in rear reservoir **1**.

NOTICE

Wear of the brake pads causes the brake fluid level in the reservoir to sink.◀



 Brake fluid level, rear (visual inspection)

Brake fluid, DOT4

It is impermissible for the brake fluid level to drop below the MIN mark.

If the brake fluid level drops below the permitted level:

- Have the defect rectified as quickly as possible by a specialist workshop, preferably an authorised BMW Motorrad dealer.

Coolant

Checking coolant level

- Make sure the ground is level and firm and place the motorcycle on its stand.
- Turn the handlebars all the way to the right.



- Check the coolant level in expansion tank **1**. Viewing direction: From in front, between windscreen and right side panel.

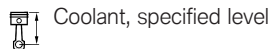

Antifreeze and corrosion inhibitor

between MIN and MAX marks on the expansion tank

If the coolant drops below the permitted level:

- Top up the coolant.

Topping up coolant

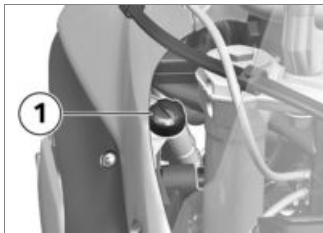

- Open cap **1** of the expansion tank.
- Using a suitable funnel, top up with coolant until the level is correct.
- Close the cap of the expansion tank.

Clutch

Checking clutch function

- Pull the clutch lever.
- » The pressure point must be clearly perceptible.

If the pressure point is not clearly perceptible:

- Have the clutch checked by a specialist workshop, preferably an authorised BMW Motorrad dealer.

Check the clutch play

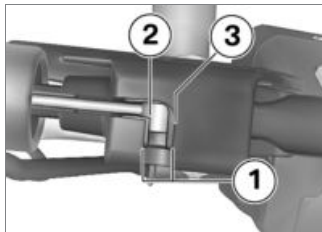

- Operate the clutch lever until resistance can be felt whilst observing the notch **1** in the manual valve.
- » The edge **2** of the brake cable should be able to move up to the edge **3** of the manual valve.



Clutch cable play

5 mm (Handlebars in straight-ahead position)

Clutch play is out of tolerance:

- Adjusting clutch play (►► 114).

Adjusting clutch play

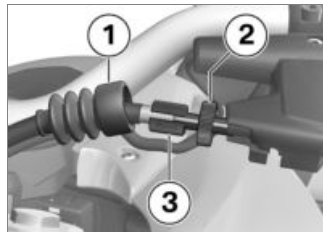

- Move the rubber grommet **1** to one side.
- Slacken nut **2**.
- To increase clutch play: Screw the adjusting screw **3** into the manual valve.

- To reduce clutch play: Unscrew the adjusting screw **3** from the manual valve.
- Check the clutch play (▣▶ 114).
- Tighten nut **2** while holding the adjusting screw **3** in position.
- Fasten the rubber grommet **1** over the nuts.

Rims and tyres

Checking rims

- Make sure the ground is level and firm and place the motorcycle on its stand.
- Visually inspect the rims for defects.
- Have any damaged rims inspected by a specialist workshop and replaced if necessary, preferably by an authorised BMW Motorrad dealer.

Check spokes

- Make sure the ground is level and firm and place the motorcycle on its stand.
- Draw the handle of a screwdriver or a similar instrument across the spokes and listen to the notes of the individual spokes.

If the notes vary:

- Have the spokes checked by a specialist workshop, preferably an authorised BMW Motorrad dealer.

Check the tyre tread depth



WARNING

Riding with badly worn tyres

Risk of accident due to impaired handling

- If applicable, have the tyres changed in good time before

they wear to the minimum tread depth permitted by law.◀

- Make sure the ground is level and firm and place the motorcycle on its stand.
- Measure the tyre tread depth in the main tread grooves with wear marks.



NOTICE

Wear indicators are built into the main profile grooves on each tyre. The tyre is worn out when the tyre tread has worn down to the level of the marks. The locations of the marks are indicated on the edge of the tyre, e.g. by the letters TI, TWI or by an arrow.◀

If the tyre tread is worn to minimum:

- Replace tyre or tyres, as applicable.

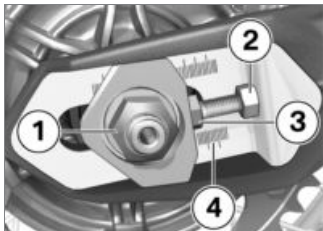

- Slacken quick-release axle nut **1**.
- Slacken locknuts **2** on left and right.
- Use adjusting screws **3** on left and right to adjust chain sag.
- Check chain sag (▣→ 116).
- Make sure that scale readings **4** are the same on left and right.
- Tighten locknuts **2** on left and right to the specified tightening torque.

 Locknut of the final-drive chain tensioning screw

19 Nm

- Tighten quick-release axle nut **1** to the specified tightening torque.

 Rear quick-release axle in swinging arm

100 Nm

Checking the chain wear

- Make sure the ground is level and firm and place the motorcycle on its stand.
- Engage 1st gear.
- Turn the rear wheel in the normal direction of travel until the chain is tensioned.
- Measure the length of the chain over 9 rivets below the rear wheel swinging arm.

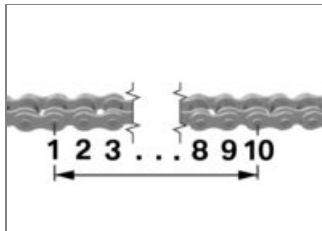

 Permissible chain length

max 144.30 mm (measured **centre to centre** over 10 pins, chain pulled taut)

If the chain has stretched to the maximum permissible length:

- Seek the advice of a specialist workshop, preferably an authorised BMW Motorrad dealer.

Wheels

Tyre recommendation

For each size of tyre, BMW Motorrad tests and classifies as roadworthy certain makes. BMW Motorrad cannot assess the suitability or provide any guarantee of road safety for other tyres.

BMW Motorrad recommends using only tyres tested by BMW Motorrad.

It is absolutely essential to observe the maximum permissible speed and load-capacity ratings (see "Technical data").

Comply with the instructions regarding maximum speed for riding with knobby tyres or winter tyres fitted (► 71).

You can obtain detailed information from your authorised BMW Motorrad dealer or on the Internet at www.bmw-motorrad.com.

Effect of wheel size on chassis and suspension control systems

Wheel size is very important as a parameter for the running-gear control systems ABS and ASC. In particular, the diameter and the width of a vehicle's wheels are programmed into the control unit and are fundamental to all calculations. Any change in these influencing variables, caused for example by a switch to wheels other than those installed ex-works, can have serious effects on the performance of the control systems.

The sensor rings are essential for correct road-speed calculation, and they too must match the motorcycle's control systems and consequently cannot be changed.

If you decide that you would like to fit non-standard wheels to your motorcycle, it is very im-

portant to consult a specialist workshop beforehand, preferably an authorised BMW Motorrad dealer. In some cases, the data programmed into the control units can be changed to suit the new wheel sizes.

Removing front wheel

- Make sure the ground is level and firm and place the motorcycle on its stand.



- Remove screw **1** and remove the ABS sensor from its bore.

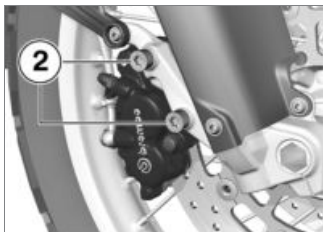

- Remove screws **2** from the right brake caliper.

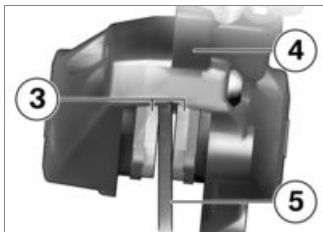

- Force the brake pads **3** slightly apart by rocking brake caliper **4** back and forth against brake disc **5**.

- Mask off the parts of the wheel rim that could be scratched in the process of removing the brake calipers.

ATTENTION

Brake pads pushed together with brake caliper removed.

It is not possible to slip the brake caliper over the brake disc.

- Do not operate the brake lever while a brake caliper has been removed.◀
- Carefully pull the brake calipers back and out until clear of the brake discs.
- Place the motorcycle on a suitable auxiliary stand.
 - with centre stand^{OE}
- Make sure the ground is level and firm and place the motorcycle on its centre stand.<
- Raise front of motorcycle until the front wheel can turn freely.

BMW Motorrad recommends the BMW Motorrad front-wheel stand for lifting the motorcycle.

- Install the front-wheel stand (▶▶ 127).

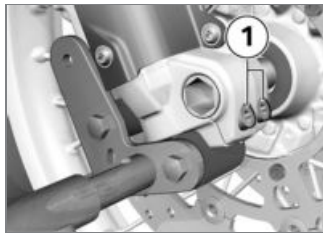

- Slacken right axle clamping screws **1**.

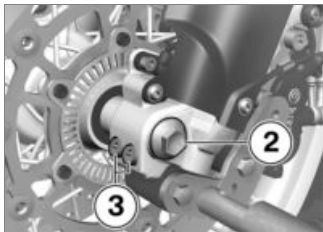

- Remove axle screw **2**.
- Slacken left axle clamping screws **3**.
- Push the axle in as far as it will go.

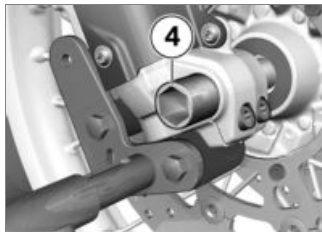

- Remove axle **4**, while supporting the wheel.
- Do not remove the grease from the axle.
- Roll the front wheel forward to remove.

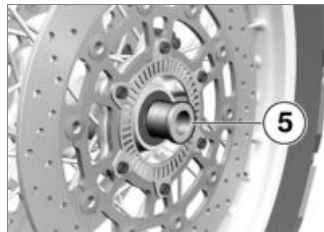

- Remove spacing bushing **5** from the left-hand side of the wheel hub.

Installing front wheel



WARNING

Use of a non-standard wheel.

Malfunctions in operation of ABS and ASC.

- See the information on the effect of wheel size on the ABS and ASC systems at the start of this chapter. ◀

ATTENTION

Tightening threaded fasteners to incorrect tightening torque.

Damage, or threaded fasteners work loose.

- Always have the security of the fasteners checked by a specialist workshop, preferably an authorised BMW Motorrad dealer. ◀

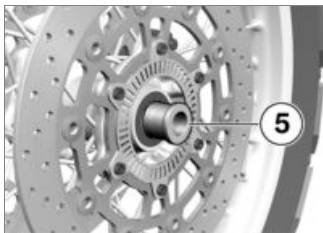

- Slip spacing bushing **5** onto the left-hand side of the wheel hub.

ATTENTION

Front wheel installed wrong way round.

Risk of accident

- Note direction-of-rotation arrows on tyre or rim. ◀
- Roll the front wheel into position between the forks, making sure that the brake disc passes between the brake pads of the brake caliper on the left.

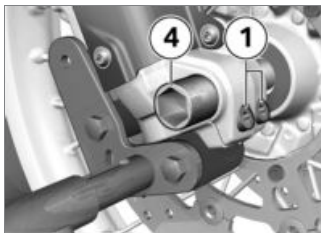

- Raise the front wheel and insert axle **4** until seated.

- Tighten right axle clamping screws **1** to the specified tightening torque or install a suitable tool to counter-hold for the next step in the assembly procedure.

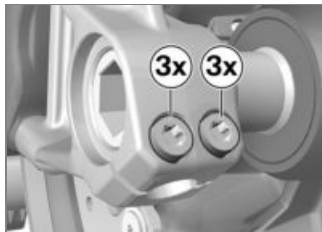

 Clamp of quick-release axle

Tightening sequence: Tighten screws six times in alternate sequence

19 Nm

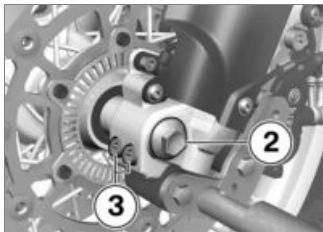

- Install axle screw **2** and tighten to the specified tightening torque.



Axle screw in quick-release axle, front

30 Nm

- Tighten left axle clamping screws **3** to the specified tightening torque.



Clamp of quick-release axle

Tightening sequence: Tighten screws six times in alternate sequence

19 Nm

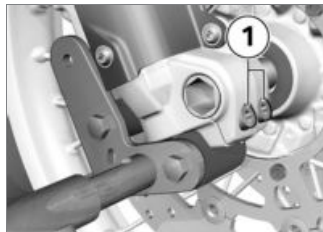

- If fully tightened beforehand, slacken right axle clamping screws **1** again.
- Remove the front-wheel stand.
 - without centre stand^{OE}
- Remove the auxiliary stand.◁
- Ease the right brake caliper onto the brake disc.

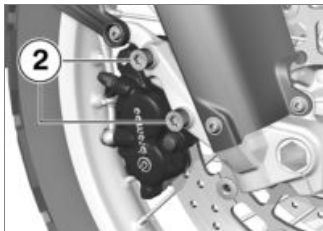

- Tighten screws **2** to the specified tightening torque.



Brake caliper to telescopic fork

38 Nm



- Insert the ABS sensor into its bore and install screw **1**.
- Remove the adhesive tape from the wheel rim.
- Operate the brake several times until the brake pads are bedded.
- Firmly compress the front forks several times.

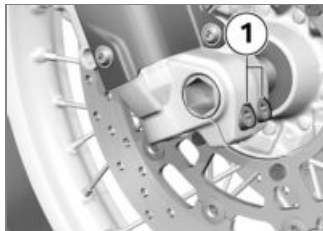

- Tighten right axle clamping screws **1** to the specified tightening torque.



Clamp of quick-release axle

Tightening sequence: Tighten screws six times in alternate sequence

19 Nm

Removing rear wheel

- Make sure the ground is level and firm and place the motorcycle on a suitable auxiliary stand.

– with centre stand^{OE}

- Make sure the ground is level and firm and place the motorcycle on its centre stand.◁

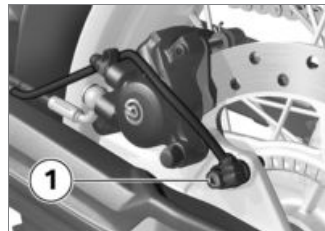

- Remove screw **1** and remove the pulse sensor from its bore.

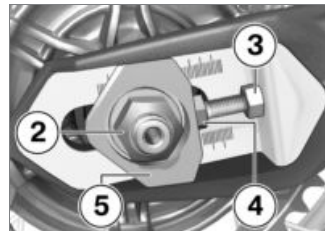

- Remove axle nut **2**.
- Slacken locknuts **3** on left and right by turning them counter-clockwise.
- Back off adjusting screws **4** on left and right by turning them counter-clockwise.
- Remove adjusting plate **5** and push the axle in as far as it will go.



- Remove quick-release axle **6** and remove adjusting plate **7**.

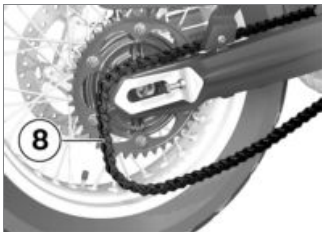

- Roll the rear wheel as far forward as possible and disengage chain **8** from the sprocket.

- Roll the rear wheel back until it is clear of the swinging arm.

NOTICE

The sprocket and the spacer sleeves on left and right are loose fits in the wheel. Take care when removing to ensure that no parts are damaged or mislaid.◀

Install the rear wheel

WARNING

Use of a non-standard wheel.

Malfunctions in operation of ABS and ASC.

- See the information on the effect of wheel size on the ABS and ASC systems at the start of this chapter.◀

ATTENTION

Tightening threaded fasteners to incorrect tightening torque.

Damage, or threaded fasteners work loose.

- Always have the security of the fasteners checked by a specialist workshop, preferably an authorised BMW Motorrad dealer.◀
- Roll the rear wheel into the swinging arm, making sure that the brake disc passes between the brake pads.

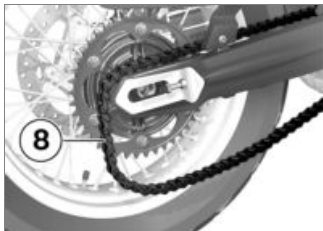

- Roll the rear wheel as far forward as possible and loop chain **8** over the sprocket.

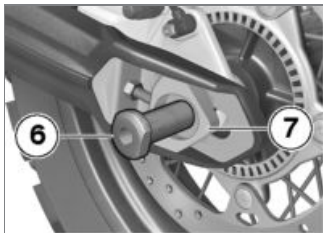

- Seat left adjusting plate **7** in the swinging arm and install quick-release axle **6** in the

brake caliper and the rear wheel.

- Make sure that the axle fits into the recess of the adjusting plate.



- Install right adjusting plate **5**.

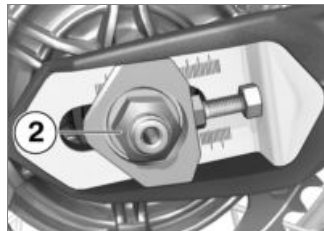

- Install nut **2**, but do not tighten it at this point.

– without centre stand^{OE}

- Remove the auxiliary stand.<

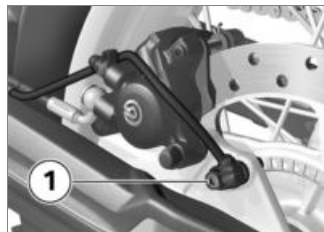

- Insert the impulse sensor into the bore and install screw **1**.

- Adjust chain sag (▮➔ 116).

Front-wheel stand

Install the front-wheel stand

ATTENTION

Use of the BMW Motorrad front wheel stand without also accompanying use of auxiliary stand.

Risk of damage to parts if vehicle topples.

- Place the motorcycle on an auxiliary stand before lifting the front wheel with the BMW Motorrad front-wheel stand.◀
- Place the motorcycle on a suitable auxiliary stand.
 - with centre stand^{OE}
- Make sure the ground is level and firm and place the motorcycle on its centre stand.<

- Use basic stand with tool number (83 30 0 402 241) in combination with front-wheel adapter (83 30 0 402 242).

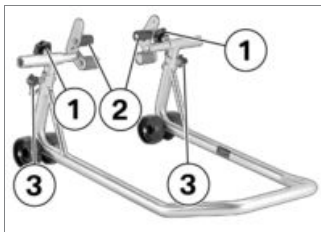

- Slacken securing screws **1**.
- Push the two adapters **2** apart until the front forks fit between them. Adjust the adapter studs to suit the front suspension.
- Use locating pins **3** to set the front-wheel stand to the desired height.
- Centre the front-wheel stand relative to the front wheel and push it against the front axle.

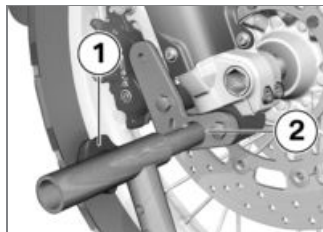

- Align the two adapters **2** so that the front forks are securely seated.
- Tighten securing screws **1**.



- Apply uniform pressure to push the front-wheel stand down and raise the motorcycle.

– with centre stand^{OE}



ATTENTION

Centre stand retracts if vehicle lifted too high.

Risk of damage to parts if vehicle topples.

- When raising the vehicle, make sure that the centre stand remains on the ground.
- If necessary, adjust the height of the front-wheel stand. ◀

- Make sure the motorcycle is standing firmly. ◀

Bulbs

Replacing low-beam and high-beam headlight bulb

- Make sure the ground is level and firm and place the motorcycle on its stand.
- Switch off the ignition.

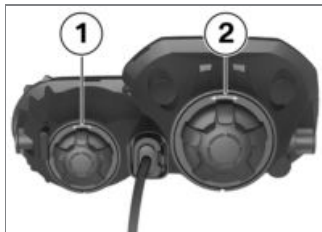

- Remove cover **1** for the high-beam headlight or cover **2** for the low-beam headlight.

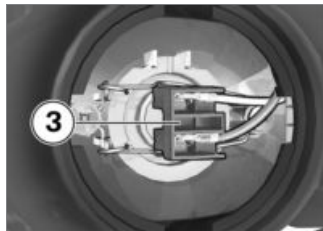

- Disconnect plug **3**.

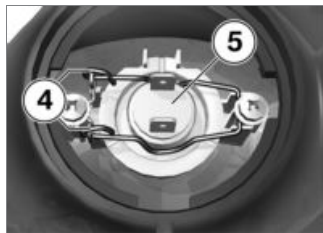

- Disengage spring clips **4** from the fastenings and swing them aside.
- Remove bulb **5**.

- Replace the defective bulb.



H7 / 12 V / 55 W

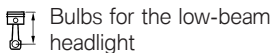

H7 / 12 V / 55 W

- Hold the new bulb by the base only, in order to keep the glass free of foreign matter.

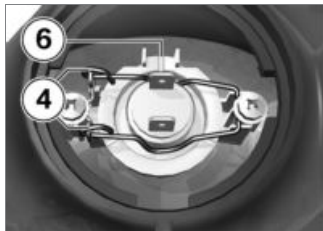

- Install the bulb, making sure that alignment is correct at position **6**.

- Close and lock spring clips **4**.

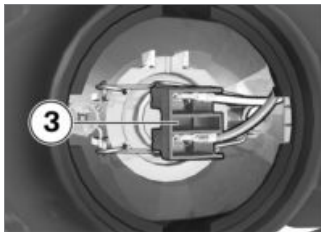

- Connect plug **3**.

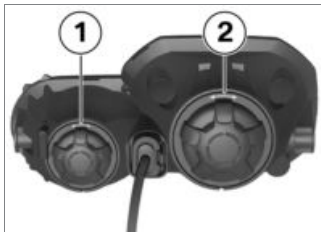

- Install cover **1** or cover **2**, as applicable.

Replacing parking-light bulb

- Make sure the ground is level and firm and place the motorcycle on its stand.
- Switch off the ignition.



- Remove cover **2**.

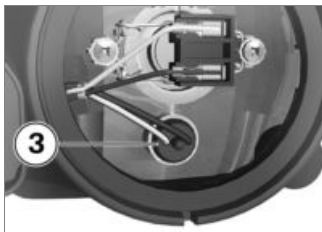

- Pull socket **3** out of the headlight housing.



- Pull the bulb out of the bulb socket.

- Replace the defective bulb.



Bulb for parking light

W5W / 12 V / 5 W



- Push the bulb into the bulb socket.

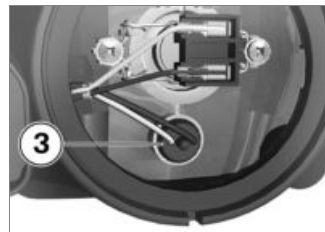

- Insert socket **3** into the headlight housing.



- Install cover **2**.

Replacing LED for brake light and tail light

- The LED rear light can be replaced only as a complete unit. Consult a specialist workshop, preferably an authorised BMW Motorrad dealer.

Replacing bulbs for front and rear turn indicators

– with LED turn indicators^{OE}

- The LED flashing turn indicators can be replaced only as a complete unit. Consult a specialist workshop, preferably an authorised BMW Motorrad dealer.◀

– without LED turn indicators^{OE}

- Make sure the ground is level and firm and place the motorcycle on its stand.
- Switch off the ignition.



- Remove screw **1**.



- Pull the glass out of the reflector housing at the threaded-fastener side.

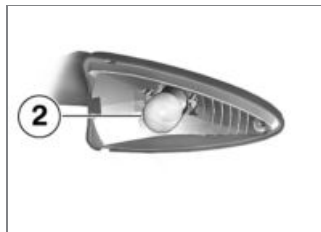

- Turn bulb **2** counter-clockwise and remove it from the light housing.
- Replace the defective bulb.

 Bulbs for flashing turn indicators, front

R10W / 12 V / 10 W

- Use a clean, dry cloth to hold the new bulb in order to keep the glass free of foreign matter.

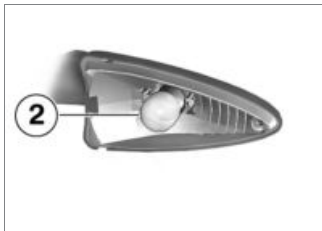

- Turn bulb **2** clockwise to install it in the bulb housing.



- Working from the inboard side, insert the glass into the light housing and close the housing.



- Install screw **1**.

Replacing number-plate light bulbs

- Make sure the ground is level and firm and place the motorcycle on its stand.
- Switch off the ignition.



- Remove screw **1** from the mudguard cover and remove the cover.

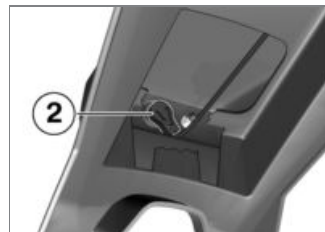

- Pull bulb holder **2** out of the light carrier.



- Pull the bulb out of the bulb socket.
- Replace the defective bulb.

 Bulb for number-plate light

W5W / 12 V / 5 W

- Use a clean, dry cloth to hold the new bulb in order to keep the glass free of foreign matter.



- Insert the bulb into the bulb socket.

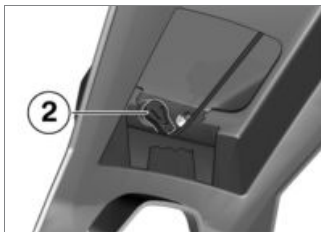

- Seat bulb holder **2** in the light carrier.



- Hold the mudguard cover in position and install screw **1**.

Replace auxiliary headlights

– with LED auxiliary headlights^{OA}

- An auxiliary headlight can only be replaced in its entirety. Consult a specialist workshop, preferably an authorised BMW Motorrad dealer.

Body panels

Removing centre trim panel

- Removing seat (→ 55).



- Remove screws **1** on left and right.

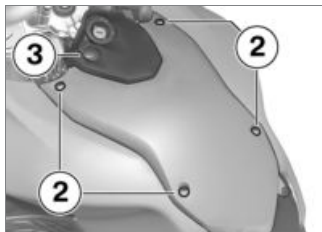

- Remove four screws **2**.
- Disconnect the plug from socket **3**.
- Remove the centre trim panel.

Installing centre trim panel

- Connect the plug to the socket.

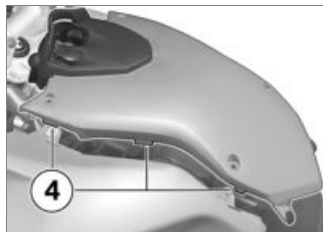

- Manoeuvre the centre trim panel into position. Make sure that all three tabs **4** on left and right engage the side panels.

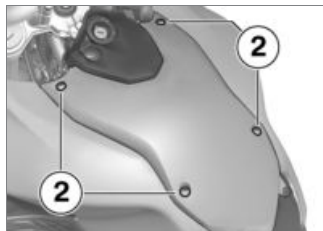

- Install four screws **2**.



- Install screws **1** on left and right.
- Installing seat (➡ 56).

Air filter

Removing air filter

- Removing centre trim panel (➡ 134).

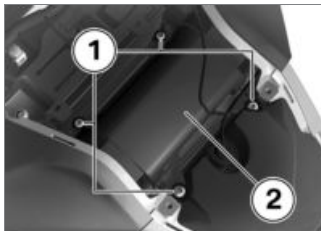

- Remove four screws **1**.
- Remove the air filter cover **2**, slightly pushing the side trim panel outwards to do so.

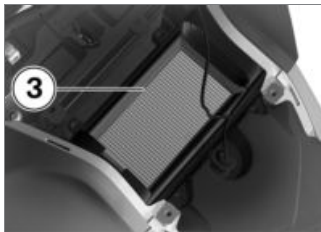

- Remove air filter **3**.

Install air filter

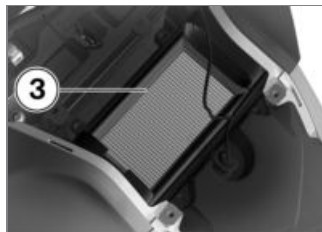

- Install air filter **3**.

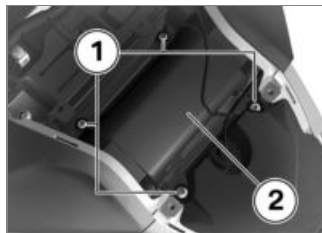

- Place air filter cover **2** in position, easing the side trim panels out slightly to do so.

- Install screws **1** with the washers.
- Installing centre trim panel (▮▮▮ 134).

Jump-starting



ATTENTION

Excessive current flowing when the motorcycle is jump-started

Wiring smoulders/ignites or damage to the on-board electronics

- If the motorcycle has to be jump-started connect the leads to the battery terminals; never attempt to jump-start the engine by connecting leads to the on-board socket.◀



ATTENTION

Contact between crocodile clips of jump leads and vehicle.

Risk of short-circuit

- Use jump leads fitted with fully insulated crocodile clips at both ends.◀



ATTENTION

Jump-starting with a voltage greater than 12 V.

Damage to the on-board electronics.

- Make sure that the battery of the donor vehicle has a voltage rating of 12 V.◀
- Removing centre trim panel (▮▮▮ 134).
- When jump-starting the engine, do not disconnect the battery from the on-board electrical system.

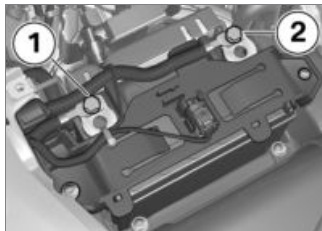

- Begin by connecting one end of the red jump lead to the positive terminal of the discharged battery and the other end to the positive terminal of the donor battery (positive on this vehicle: position **2**).
- Then connect one end of the black jump lead to the negative terminal of the donor battery and the other end to the negative terminal of the discharged battery (negative on this vehicle: position **1**).

 **NOTICE**

The spring-strut screw can be used as an alternative to the battery's negative terminal.◀

- Run the engine of the donor vehicle during jump-starting.
- Start the engine of the vehicle with the discharged battery in the usual way; if the engine does not start, wait a few minutes before repeating the attempt in order to protect the starter motor and the donor battery.
- Allow both engines to idle for a few minutes before disconnecting the jump leads.
- Disconnect the jump lead from the negative terminals first, then disconnect the second lead from the positive terminals.

 **NOTICE**

Do not use proprietary start-assist sprays or other products to start the engine.◀

- Installing centre trim panel (➔ 134).

Battery

Maintenance instructions

Correct upkeep, recharging and storage will prolong the life of the battery and are essential if warranty claims are to be considered.

Compliance with the points below is important in order to maximise battery life:

- Keep the surface of the battery clean and dry.
- Do not open the battery.
- Do not top up with water.
- Be sure to read and comply with the instructions for char-

ging the battery on the following pages.

- Do not turn the battery upside down.

 **ATTENTION**

On-board electronics (e.g. clock) draining connected battery.

Battery is deep-discharged; this voids the guarantee.

- Connect a float charger to the battery if the motorcycle is to remain out of use for more than four weeks.◀

 **NOTICE**

BMW Motorrad has developed a float charger specially designed for compatibility with the electronics of your motorcycle. Using this charger, you can keep the battery charged during long periods of disuse, without having

to disconnect the battery from the motorcycle's on-board systems. You can obtain additional information from your authorised BMW Motorrad dealer.◀

Charge battery when connected

- Disconnect devices plugged into the sockets.

ATTENTION

Charging connected battery via the battery terminals.

Damage to the on-board electronics.

- Disconnect the battery at the battery terminals before charging.◀

ATTENTION

Unsuitable battery chargers connected to an on-board socket.

Damage to charger and to frame and suspension electronics.

- Use suitable BMW chargers. The suitable charger is available from your authorised BMW Motorrad dealer.◀

ATTENTION

Charging a fully discharged battery via the on-board socket or the extra socket.

Damage to the on-board electronics.

- If a battery has discharged to the extent that it is completely flat (battery voltage less than 9 V, status-indicator lights and multifunction display remain off when the ignition is switched on) **it has to be disconnected from the on-board circuits** and re-charged with the charger connected directly to the battery posts.◀

- Charge via the charging socket, with the battery connected to the motorcycle's on-board electrical system.

NOTICE

The motorcycle's on-board electronics know when the battery is fully charged. The on-board socket is switched off when this happens.◀

- Comply with the operating instructions of the charger.

NOTICE

If you are unable to charge the battery through the on-board socket, you may be using a charger that is not compatible with your motorcycle's electronics. If this happens, disconnect the battery from the on-board systems and connect the charger directly to the battery.◀

Charging battery when disconnected

- Charge the battery using a suitable charger.
- Comply with the operating instructions of the charger.
- After charging, remove the pole terminal of the charger from the battery posts.

NOTICE

The battery has to be recharged at regular intervals in the course of a lengthy period of disuse. See the instructions for caring for your battery. Always fully recharge the battery before restoring it to use.◀

Removing battery

- Removing seat (➡ 55).
- Removing centre trim panel (➡ 134).

- Make sure the ground is level and firm and place the motorcycle on its stand.
 - with alarm system (DWA)^{OE}
- If applicable, switch off the anti-theft alarm.◀
- Switch off the ignition.

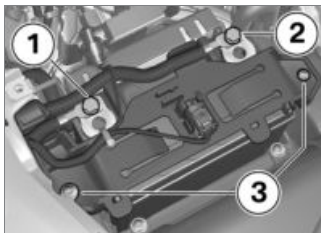

ATTENTION

Battery not disconnected in accordance with correct procedure.

Risk of short-circuit

- Always proceed in compliance with the specified disconnection sequence.◀
- Disconnect negative lead **1** first.
- Then disconnect positive lead **2**.
- Remove the screws **3** on left and right and pull the battery holder forward, away from the battery.
- Lift the battery up and out; work it slightly back and forth if it is difficult to remove.

Installing battery

NOTICE

If the battery was disconnected from the motorcycle for a prolonged period of time it will be necessary to enter the current date in the instrument panel, in order to ensure that the service-due indicator functions correctly.

If you want to have the date set consult a specialist workshop, preferably an authorised BMW Motorrad dealer.◀

- Switch off the ignition.
- Insert the battery into the battery compartment, with the positive terminal on the right in the direction of travel.

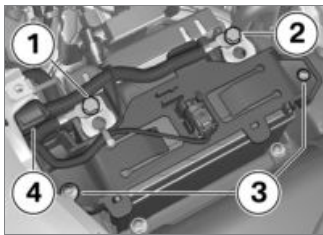

- Place the battery holder in position, making sure that the leads are correctly routed at position **4**.
- Install screws **3** on left and right.



ATTENTION

Battery not connected in accordance with correct procedure.

Risk of short-circuit

- Always proceed in compliance with the specified installation sequence.◀
- Connect positive lead **2** to the battery's positive terminal.
- Connect negative lead **1** to the battery's negative terminal.
- Installing centre trim panel (▣▣▣ 134).
- Installing seat (▣▣▣ 56).
- Setting clock (▣▣▣ 37).

Care

Care products	142
Washing the vehicle	142
Cleaning easily damaged components.....	143
Paint care	143
Laying up the motorcycle	144
Protective wax coating	144
Restoring motorcycle to use	144

Care products

BMW Motorrad recommends that you use the cleaning and care products you can obtain from your authorised BMW Motorrad dealer. The substances in BMW Care Products have been tested in laboratories and in practice; they provide optimised care and protection for the materials used in your vehicle.



ATTENTION

Use of unsuitable cleaning and care products.

Damage to vehicle parts.

- Do not use solvents such as cellulose thinners, cold cleaners, fuel or the like, and do not use cleaning products that contain alcohol. ◀

Washing the vehicle

BMW Motorrad recommends that you use BMW insect remover to soften and wash off insects and stubborn dirt on painted parts prior to washing the motorcycle.

To prevent stains, do not wash the vehicle immediately after it has been exposed to strong sunlight and do not wash it in the sun.

Make sure that the vehicle is washed frequently, especially during the winter months.

To remove road salt, clean the motorcycle with cold water immediately after every trip.



WARNING

Wet brake discs and brake pads after vehicle wash, after riding through water and in rainy conditions.

Diminished braking effect.

- Apply the brakes in good time to allow the friction and heat to dry the brake discs and brake pads. ◀



ATTENTION

Effect of road salt intensified by warm water.

Corrosion

- Use only cold water to wash off road salt. ◀



ATTENTION

Damage due to high water pressure from high pressure cleaners or steam cleaners.

Corrosion or short-circuit, damage to seals, to the hydraulic brake system, to the electrics and the seat.

- Exercise restraint when using a steam jet or high-pressure cleaning equipment. ◀

Cleaning easily damaged components

Plastics

ATTENTION

Use of unsuitable cleaning agents.

Damage to plastic surfaces.

- Do not use cleaning agents that contain alcohol, solvents or abrasives.
- Do not use insect-remover pads or cleaning pads with hard, scouring surfaces.◀

Body panels

Clean the trim panels with water and BMW plastic care emulsion.

Windscreens and lenses made of plastic

Clean off dirt and insects with a soft sponge and plenty of water.

NOTICE

Soften stubborn dirt and insects by covering the affected areas with a wet cloth.◀

Chrome

Use plenty of water and BMW shampoo to clean chrome, particularly if it has been exposed to road salt. Use chrome polish for additional treatment.

Radiator

Clean the radiator regularly to prevent overheating of the engine due to inadequate cooling. For example, use a garden hose with low water pressure.

ATTENTION

Radiator fins easily bent.

Damage to radiator fins.

- Take care not to bend the radiator fins when cleaning.◀

Rubber

Treat rubber components with water or BMW rubber-care products.

ATTENTION

Application of silicone sprays to rubber seals.

Damage to the rubber seals.

- Do not use silicone sprays or care products that contain silicon.◀

Paint care

Washing the vehicle regularly will help counteract the long-term effects of substances that can damage the paint, especially if your vehicle is ridden in areas with high air pollution or natural sources of dirt, for example tree resin or pollen.

Remove particularly aggressive substances immediately, however, as otherwise the paint can

be affected or become discoloured. Substances of this nature include spilt fuel, oil, grease, brake fluid and bird droppings. We recommend BMW vehicle polish or BMW paint cleaner for this purpose.

Marks on the paintwork are particularly easy to see after the motorcycle has been washed. Remove stains of this kind immediately, using cleaning-grade benzene or petroleum spirit on a clean cloth or ball of cotton wool. BMW Motorrad recommends BMW tar remover for removing specks of tar. Remember to wax the parts treated in this way.

Laying up the motorcycle

- Clean the motorcycle.
- Fill the motorcycle's fuel tank.
- Removing battery (☞ 139).

- Spray the brake and clutch lever pivots and the main and side stand pivots with a suitable lubricant.
- Coat bright metal and chrome-plated parts with an acid-free grease (e.g. Vaseline).
- Stand the motorcycle in a dry room in such a way that there is no load on either wheel (preferably using the front-wheel and rear-wheel stands from BMW Motorrad).

Protective wax coating

BMW Motorrad recommends applying only BMW car wax or products containing carnauba wax or synthetic wax.

It is time to rewax the paintwork when water "puddles" on the surface, instead of forming beads.

Restoring motorcycle to use

- Remove the protective wax coating.
- Clean the motorcycle.
- Installing battery (☞ 139).
- Comply with checklist (☞ 73).

Technical data

Troubleshooting chart	146
Threaded fasteners	147
Engine	149
Fuel.....	150
Engine oil	151
Clutch	152
Transmission	152
Rear-wheel drive.....	153
Running gear	153
Brakes	154
Wheels and tyres	154
Electrics	156
Frame	157
Dimensions	157
Weights.....	158

Riding specifications	159
-----------------------------	-----

Troubleshooting chart

Engine does not start or is difficult to start:

Possible cause	Rectification
Kill switch activated	Set emergency-off switch (kill switch) to operating position.
Side stand extended and gear engaged	Select neutral or retract the side stand.
Gear engaged and clutch not disengaged	Select neutral or pull the clutch lever.
No fuel in tank	Refuelling (▣▶ 81).
Battery flat	Charge battery when connected (▣▶ 138).

Threaded fasteners

Front wheel	FR	Valid
Brake caliper to telescopic fork		
M10 x 40	38 Nm	
Clamp of quick-release axle		
M8 x 25	Tighten screws six times in alternate sequence	
	19 Nm	
Axle screw in quick-release axle, front		
M14 x 1.5	30 Nm	
Rear wheel	FR	Valid
Locknut of the final-drive chain tensioning screw		
M8	19 Nm	
Rear quick-release axle in swinging arm		
M16 x 1.5	100 Nm	

Mirror arm	FR	Valid
Locknut (mirror) to clamping piece		
M10 x 1.5 Multi-wax spray	20 Nm	
Clamping piece (mirror) to clamping block		
M10	30 Nm	

Engine

Engine design	Two-cylinder four-stroke, DOHC, 4 valves operated by cam followers, liquid-cooled cylinders and heads, integral coolant pump, 6-speed gearbox and dry sump lubrication
Displacement	798 cm ³
Cylinder bore	82 mm
Piston stroke	75.6 mm
Compression ratio	12 : 1
Nominal output	63 kW, - at engine speed: 7500 min ⁻¹
– with regular unleaded ^{OE}	61 kW, - at engine speed: 7500 min ⁻¹
– with power reduction to 35 kW ^{OE}	35 kW, - at engine speed: 7000 min ⁻¹
– with power reduction to 25 kW ^{OE}	25 kW, - at engine speed: 7000 min ⁻¹
Torque	83 Nm, - at engine speed: 5750 min ⁻¹
– with regular unleaded ^{OE}	81 Nm, - at engine speed: 5750 min ⁻¹
– with power reduction to 35 kW ^{OE}	63 Nm, - at engine speed: 4000 min ⁻¹
– with power reduction to 35 kW ^{OE} – with regular unleaded ^{OE}	61 Nm, - at engine speed: 4000 min ⁻¹
– with power reduction to 25 kW ^{OE}	55 Nm, - at engine speed: 3500 min ⁻¹
Maximum engine speed	max 9000 min ⁻¹

Idle speed	1250 ⁺⁵⁰ min ⁻¹ , vehicle at standstill
------------	---

Fuel

Recommended fuel grade	Super unleaded (max. 10 % ethanol, E10) 95 ROZ/RON 89 AKI
- with regular unleaded ^{OE}	Regular unleaded (slight power- and consumption-related restrictions) (max. 10 % ethanol, E10) 91 ROZ/RON 87 AKI
Usable fuel capacity	approx. 16 l
Reserve fuel	min 2.7 l

Clutch

Clutch type	Multiplate clutch running in oil bath
-------------	---------------------------------------

Transmission

Gearbox type	Claw-shift 6-speed transmission, integrated into engine block
Gearbox transmission ratios	1.943 (35/68 teeth), Primary transmission ratio 1:2.462 (13/32 teeth), 1st gear 1:1.750 (16/28 teeth), 2nd gear 1:1.381 (21/29 teeth), 3rd gear 1:1.174 (23/27 teeth), 4th gear 1:1.042 (24/25 teeth), 5th gear 1:0.960 (25/24 teeth), 6th gear

Rear-wheel drive

Type of final drive	Chain drive
Type of rear suspension	Two-arm cast-aluminium swinging arm
Final drive, number of teeth (Pinion / sprocket)	16/42

Running gear

Front wheel

Type of front suspension	Upside-down fork
Spring travel, front	230 mm, At wheel
– with lowered suspension ^{OE}	190 mm, At wheel

Rear wheel

Type of rear suspension	Two-arm cast-aluminium swinging arm
Type of rear suspension	Direct-pivot central spring strut with steplessly adjustable rebound-stage damping
Spring travel at rear wheel	215 mm, At wheel
– with lowered suspension ^{OE}	190 mm, At wheel

Brakes

Front wheel

Type of front brake	Hydraulically operated twin disc brake with 2-piston floating calipers and floating brake discs
Brake-pad material, front	Sintered metal

Rear wheel

Type of rear brake	Hydraulically actuated disc brake with 1-piston floating caliper and fixed disc
Brake-pad material, rear	Organic material

Wheels and tyres

Recommended tyre sets	Your authorised BMW Motorrad dealer will be happy to supply an up-to-date list of the approved wheel/tyre combinations, or you can check the information posted on the bmw-motorrad.com website.
Speed category, front/rear tyres	V, required at least: 240 km/h

Front wheel

Front wheel type	Spoked wheel, MT H2
Front wheel rim size	2.15" x 21"
Tyre designation, front	90 / 90 - 21
Load index, front tyre	min. 42
Permissible front-wheel imbalance	max. 5 g

Rear wheel

Rear-wheel type	Spoked wheel, MT H2
Rear wheel rim size	4.25" x 17"
Tyre designation, rear	150 / 70 - 17
Load index, rear tyre	min. 66
Permissible rear-wheel imbalance	max. 45 g

Tyre pressure

Tyre pressure, front	2.2 bar, one-up, tyre cold 2.5 bar, two-up and/or with luggage, tyre cold
Tyre pressure, rear	2.5 bar, one-up, tyre cold 2.9 bar, two-up and/or with luggage, tyre cold

Electrics

Electrical rating of on-board sockets	5 A
Fuses	Electronic fuses protect all the circuits. If an electronic fuse trips and de-energises a circuit, the circuit is active as soon as the ignition is switched on after the fault has been rectified.

Battery

Battery type	AGM (Absorbent Glass Mat) battery
Battery rated voltage	12 V
Battery rated capacity	12 Ah

Spark plugs

Spark plugs, manufacturer and designation	NGK DCPR 8 E
Electrode gap of spark plug	0.8...0.9 mm, when new

Lighting

Bulb for high-beam headlight	H7 / 12 V / 55 W
Bulbs for the low-beam headlight	H7 / 12 V / 55 W
Bulb for parking light	W5W / 12 V / 5 W
Bulb for tail light/brake light	LED

Maximum number of defective LEDs in rear-light unit	6, Brake light/rear light
Bulb for number-plate light	W5W / 12 V / 5 W
Bulbs for flashing turn indicators, front	R10W / 12 V / 10 W
Bulbs for flashing turn indicators, rear	R10W / 12 V / 10 W

Frame

Frame type	Tubular spaceframe
Type plate location	Steering head, front top
Position of the Vehicle Identification Number	Frame, front right, on steering head

Dimensions

Length of motorcycle	2300 mm, across front wheel to number-plate carrier
Height of motorcycle	1345 mm, across windscreen, without rider at unladen weight (as per DIN standard)
– with lowered suspension ^{OE}	1315 mm, across windscreen, without rider at unladen weight (as per DIN standard)
Width of motorcycle	890 mm, across handlebars without mirrors

Front-seat height	880 mm, Without rider at unladen weight
– with Comfort seat ^{OE}	895 mm, Without rider at unladen weight
– with seat, low ^{OE}	850 mm, Without rider at unladen weight
– with lowered suspension ^{OE}	820 mm, Without rider at unladen weight
Rider's inside-leg arc, heel to heel	1930 mm, Without rider at unladen weight
– with seat, low ^{OE}	1880 mm, Without rider at unladen weight
– with Comfort seat ^{OE}	1960 mm, Without rider at unladen weight
– with lowered suspension ^{OE}	1790 mm, Without rider at unladen weight

Weights

Unladen weight	214 kg, DIN unladen weight, ready for road, 90 % load of fuel, without OE
Permissible gross weight	444 kg
Maximum payload	230 kg

Riding specifications

Top speed	>200 km/h
– with power reduction to 35 kW ^{OE}	165 km/h
– with power reduction to 25 kW ^{OE}	136 km/h

Service

BMW Motorrad Service	162
BMW Motorrad Mobility services	162
Maintenance work	162
Maintenance schedule	165
Standard BMW service	166
Confirmation of maintenance work	167
Confirmation of service	172

BMW Motorrad Service

BMW Motorrad has an extensive network of dealerships in place to look after you and your motorcycle in more than 100 countries. Authorised BMW Motorrad dealerships have the technical information and the technical know-how to reliably carry out all maintenance and repair work on your BMW.

Visit our website www.bmw-motorrad.com to find out where the nearest authorised BMW Motorrad dealership is located.



WARNING

Maintenance and repair work not in compliance with correct procedure.

Risk of accident due to subsequent damage.

- BMW Motorrad recommends you to have all the associated

work on your motorcycle carried out by a specialist workshop, preferably an authorised BMW Motorrad dealer. ◀

In order to help ensure that your BMW is always in optimum condition, BMW Motorrad recommends compliance with the maintenance intervals specified for your motorcycle. Have all maintenance and repair work carried out confirmed in the "Service" chapter in this manual. For generous treatment of claims submitted after the warranty period has expired, evidence of regular maintenance is essential.

Your authorised BMW Motorrad dealer can provide information on BMW services and the work undertaken as part of each service.

BMW Motorrad Mobility services

As owner of a new BMW motorcycle, in circumstances in which assistance is required you can benefit from the protection afforded by the various BMW Motorrad mobility services (e.g. Mobile Service, breakdown service, vehicle recovery service). Your authorised BMW Motorrad dealer will be happy provide information about the mobility services available to you.

Maintenance work

BMW Pre-delivery Check

Your authorised BMW Motorrad dealer conducts the BMW pre-delivery check before handing over the vehicle to you.

BMW Running-in Check

The BMW running-in check has to be performed when the vehicle has covered between 500 km and 1200 km.

BMW Service

The BMW Service is carried out once a year; the extent of servicing can vary, depending on the age of the vehicle and the distance it has covered. Your authorised BMW Motorrad dealer confirms that the service work has been carried out and enters the date when the next service will be due.

Riders who cover long distances in a year might have to bring in their vehicles for service before the next scheduled date. It is to allow for these cases that a maximum odometer reading is entered as well in the confirmation of service. Servicing has to be brought forward if this odo-

meter reading is reached before the next scheduled date for the service.

The service-due indicator in the multifunction display reminds you about one month or 1000 km in advance when the time for a service is approaching, on the basis of the programmed values.

To find out more about service go to:

bmw-motorrad.com/service

The maintenance tasks necessary for your vehicle are set out in the maintenance schedule below:

Maintenance schedule

- 1** BMW Running-in check
- 2** Standard BMW service
( 166)
- 3** Engine-oil change, with filter
- 4** Check valve clearance
- 5** Replace all spark plugs
- 6** Replace air-filter element
- 7** Check or replace air-filter element
- 8** Oil change in the telescopic forks
- 9** Change brake fluid, entire system
 - a** annually or every 10,000 km (whichever comes first)
 - b** if vehicle is used off-road, annually or every 10,000 km (whichever comes first)
 - c** for the first time after one year, then every two years

Standard BMW service

A standard BMW service consists of the following maintenance work:

- Perform vehicle test with the BMW Motorrad diagnosis system.
- Check the coolant level.
- Check/adjust the clutch play.
- Check the freedom of movement of the throttle cable and check for kinks and chafing.
- Check the front and rear brake pads and brake discs for wear.
- Check the front and rear brake-fluid levels.
- Visually inspect the brake pipes, brake hoses and connections.
- Check the spoke tension, adjust if necessary.
- Check the tyre pressures and tread depth.
- Check and lubricate the chain drive.
- Check the ease of movement of the side stand.
- Check the ease of movement of the centre stand (if vehicle fitted with the "centre stand" optional extra).
- Check the steering-head bearing.
- Check the lights and signalling equipment.
- Check that the engine start suppression system is in working order.
- Perform final inspection and check of roadworthiness.
- Set the service-due date and service countdown distance.
- Check the battery charge state.
- Confirm BMW service in the on-board documentation.

Confirmation of maintenance work

BMW Pre-delivery Check

Completed

on _____

Stamp, signature

BMW Running-in Check

Completed

on _____

Odometer reading _____

Next service
at the latest

on _____

or, if logged beforehand,

Odometer reading _____

Stamp, signature

BMW Service

Completed

on _____

Odometer reading _____

Next service
at the latest

on _____

or, if logged beforehand,

Odometer reading _____

Stamp, signature**BMW Service**

Completed

on _____

Odometer reading _____

Next service
at the latest

on _____

or, if logged beforehand,

Odometer reading _____

Stamp, signature**BMW Service**

Completed

on _____

Odometer reading _____

Next service
at the latest

on _____

or, if logged beforehand,

Odometer reading _____

Stamp, signature

BMW Service

Completed

on _____

Odometer reading _____

Next service
at the latest

on _____

or, if logged beforehand,

Odometer reading _____

Stamp, signature**BMW Service**

Completed

on _____

Odometer reading _____

Next service
at the latest

on _____

or, if logged beforehand,

Odometer reading _____

Stamp, signature**BMW Service**

Completed

on _____

Odometer reading _____

Next service
at the latest

on _____

or, if logged beforehand,

Odometer reading _____

Stamp, signature

BMW Service

Completed

on _____

Odometer reading _____

Next service
at the latest

on _____

or, if logged beforehand,

Odometer reading _____

Stamp, signature**BMW Service**

Completed

on _____

Odometer reading _____

Next service
at the latest

on _____

or, if logged beforehand,

Odometer reading _____

Stamp, signature**BMW Service**

Completed

on _____

Odometer reading _____

Next service
at the latest

on _____

or, if logged beforehand,

Odometer reading _____

Stamp, signature

BMW Service

Completed

on _____

Odometer reading _____

Next service
at the latest

on _____

or, if logged beforehand,

Odometer reading _____

Stamp, signature**BMW Service**

Completed

on _____

Odometer reading _____

Next service
at the latest

on _____

or, if logged beforehand,

Odometer reading _____

Stamp, signature**BMW Service**

Completed

on _____

Odometer reading _____

Next service
at the latest

on _____

or, if logged beforehand,

Odometer reading _____

Stamp, signature

Confirmation of service

The table is intended as a record of maintenance and repair work, the installation of optional accessories and, if appropriate, special campaign (recall) work.

Item	Odometer reading	Date

Item	Odometer reading	Date

Appendix

Certificate for electronic immobiliser	176
--	-----

FCC Approval

Ring aerial in the ignition switch



To verify the authorization of the ignition key, the electronic immobilizer exchanges information with the ignition key via the ring aerial.

This device complies with Part 15 of the FCC rules. Operation is subject to the following two conditions:

- (1) This device may not cause harmful interference, and
- (2) this device must accept any interference received, including interference that may cause undesired operation.



Any changes or modifications not expressly approved by the party responsible for compliance could void the user's authority to operate the equipment. ◀

Approbation de la FCC

Antenne annulaire présente dans le commutateur d'allumage



Pour vérifier l'autorisation de la clé de contact, le système d'immobilisation électronique échange des

informations avec la clé de contact via l'antenne annulaire.

Le présent dispositif est conforme à la partie 15 des règles de la FCC. Son utilisation est soumise aux deux conditions suivantes :

- (1) Le dispositif ne doit pas produire d'interférences nuisibles, et
- (2) le dispositif doit pouvoir accepter toutes les interférences extérieures, y compris celles qui pourraient provoquer une activation inopportune.



Toute modification qui n'aurait pas été approuvée expressément par l'organisme responsable de l'homologation peut annuler l'autorisation accordée à l'utilisateur pour utiliser le dispositif. ◀

A

- Abbreviations and symbols, 6
- ABS
 - Control, 16
 - Engineering details, 87
 - Operation, 44
 - Self-diagnosis, 75
 - Warnings, 32
- Accessories
 - General instructions, 92
- Actuality, 7
- Air filter
 - Installation, 135
 - Position on the vehicle, 15
 - Removal, 135
- Aluminium case
 - Operation, 100
- Aluminium topcase
 - Operation, 102
- Ambient temperature
 - Outside temperature warning, 32
 - Reading, 26

ASC

- Control, 16
 - Engineering details, 89
 - Operation, 45
 - Self-diagnosis, 75
 - Warnings, 33
- Auxiliary headlights
- Operation, 93
- Average values
- Resetting, 39

B

- Battery
- Charging battery when connected, 138
 - Charging battery when disconnected, 139
 - Installation, 139
 - Maintenance instructions, 137
 - Position on the vehicle, 15
 - Removal, 139
 - Technical data, 156

Brake fluid

- Checking fluid level, front, 111
 - Checking fluid level, rear, 112
 - Reservoir, front, 13
 - Reservoir, rear, 13
- Brake pads
- Checking front, 109
 - Checking rear, 110
 - Running in, 76
- Brakes
- Adjusting handlebar lever, 49
 - Checking operation, 109
 - Safety instructions, 79
 - Technical data, 154
-
- C**
- Cases
- Operation, 94
- Chain
- Adjusting sag, 116
 - Checking sag, 116
 - Checking wear, 117
 - Lubricating, 116
- Checklist, 73

- Clock
 - adjusting, 37
 - Control, 19
- Clutch
 - Adjusting handlebar lever, 48
 - Adjusting play, 114
 - Checking operation, 114
 - Checking play, 114
 - Technical data, 152
- Confirmation of maintenance work, 167
- Coolant
 - Checking fill level, 113
 - Fill-level indicator, 13
 - Topping up, 114
 - Warning for overtemperature, 30
- D**
 - Damping
 - Adjuster, 13
 - adjusting, 51
 - Dimensions
 - Technical data, 157
- DWA
 - Telltale light, 19
 - Warnings, 32
- E**
 - Electrics
 - Technical data, 156
 - Emergency off switch (kill switch), 18
 - Operation, 43
 - Engine
 - starting, 73
 - Technical data, 149
 - Warning for engine electronics, 31
 - Engine oil
 - Checking fill level, 107
 - Filler neck, 11
 - Oil dipstick, 11
 - Technical data, 151
 - Topping up, 108
 - Equipment, 7
 - ESA
 - Control, 16
 - Operation, 52
- F**
 - First-aid kit
 - Stowage, 14
 - Frame
 - Technical data, 157
 - Front-wheel stand
 - Installing, 127
 - Fuel
 - Filler neck, 13
 - Fill-level indicator, 25
 - Refuelling, 81
 - Reserve volume, 25
 - Technical data, 150
 - Fuel reserve
 - Warning, 30
 - Fuses, 156
- G**
 - General views
 - Instrument panel, 19
 - Left side of vehicle, 11
 - Multifunction display, 22
 - Multifunction switch, left, 16
 - Right handlebar fitting, 18
 - Right side of motorcycle, 13
 - Underneath the seat, 14

Underneath the trim panel, 15
Warning and telltale lights, 24

H

Hazard warning flashers
Control, 16
Operation, 42

Headlight

Adjusting headlight beam
throw, 55
Beam throw, 54
Driving on right/driving on
left, 54

Heated handlebar grips

Control, 18
Operation, 43

Helmet holder

Helmet, securing, 56
Position on the motorcycle, 14

Horn, 16

I

Ignition

Switching off, 36
Switching on, 36

Immobiliser

Reserve key, 37
Warning, 30

Instrument panel

Ambient-light brightness
sensor, 19
Overview, 19

J

Jump starting, 136

K

Keys, 36

L

Lighting

Replace auxiliary
headlights, 133
Replacing brake and tail light
bulb, 131
Replacing high-beam headlight
bulb, 128
Replacing low-beam headlight
bulb, 128
Replacing number-plate light
bulbs, 132

Replacing side-light bulb, 129

Replacing turn indicator
bulbs, 131

Technical data, 156

Warning for bulb failure, 31

Lights

Control, 16
Headlight flasher, operating, 41
High-beam headlight,
operating, 41
Low-beam headlight, 41
Parking lights, operating, 41
Side light, 41

Lowered suspension

Restrictions, 70

Luggage

Instructions for loading, 70
Lashing, 93

M

Maintenance

General instructions, 106
Maintenance schedule, 165

Maintenance intervals, 162

Mirrors
 adjusting, 50

Mobility services, 162

Motorcycle
 Care, 141
 Cleaning, 141
 Lashing, 82
 Laying up, 144
 Parking, 80

Multifunction display, 19
 Control, 16
 Meaning of symbols, 23
 Overview, 22
 Select display, 38

Multifunction switch
 General view, left side, 16
 General view, right side, 18

O

Odometer
 Control, 19
 Resetting, 39

Off-road mode
 adjusting, 46
 Control, 18
 Engineering details, 86

Off-roading, 78

P

Parking, 80

Power socket
 Notes on use, 92
 Position on the vehicle, 11

Pre-Ride-Check, 74

R

Rear-wheel drive
 Technical data, 153

Redline warning
 Switching on, 77
 Warning light, 19

Refuelling, 81

Rev. counter, 19

Rider's Manual
 Position on the motorcycle, 14
 Stowage, 57

Riding mode, 46

Running gear
 Technical data, 153

Running in, 76

S

Safety instructions
 For brake, 79
 For riding, 70

Seat
 Installation, 55
 Lock, 11
 Removal, 55

Service, 162

Service-due indicator, 26

Spark plugs
 Technical data, 156

Speedometer, 19

Spring preload
 Adjuster, 13
 adjusting, 50
 Tools, 14

Starting, 73
 Control, 18

Steering lock
 Locking, 36

- Stopwatch
 - Operation, 39
- Symbols
 - Meaning, 23

T

- Technical data
 - Battery, 156
 - Brakes, 154
 - Bulbs, 156
 - Clutch, 152
 - Dimensions, 157
 - Electrics, 156
 - Engine, 149
 - Engine oil, 151
 - Frame, 157
 - Fuel, 150
 - Rear-wheel drive, 153
 - Running gear, 153
 - Spark plugs, 156
 - Standards, 7
 - Transmission, 152
 - Weights, 158
 - Wheels and tyres, 154

- Telltale lights
 - Overview, 24
- Toolkit
 - Contents, 106
 - Position on the motorcycle, 14
- Topcase
 - Operation, 97
- Torques, 147
- Transmission
 - Technical data, 152
- Trim panels
 - Installing centre trim panel, 134
 - Removing centre trim panel, 134
- Troubleshooting chart, 146
- Turn indicators
 - Control, 16
 - Operation, 42
- Type plate
 - Position on the motorcycle, 13
- Tyres
 - Checking inflation pressure, 54
 - Checking tread depth, 115
 - Pressures, 155
 - Recommendation, 118

- Running in, 76
- Table of tyre pressures, 14
- Technical data, 154
- Top speed, 71

V

- Vehicle
 - Restoring to use, 144
- Vehicle Identification Number
 - Position on the motorcycle, 13

W

- Warning lights
 - Overview, 24
- Warnings
 - ABS, 32
 - Anti-theft alarm, 32
 - ASC, 33
 - Bulb defect, 31
 - Coolant temperature, 30
 - Engine electronics, 31
 - Fuel reserve, 30
 - Immobiliser, 30
 - Mode of presentation, 27

- Outside temperature warning, 32
- Warnings, overview, 28
- Weights
 - Payload table, 14
 - Technical data, 158
- Wheels
 - Change of size, 118
 - Check spokes, 115
 - Checking rims, 115
 - Install the rear wheel, 125
 - Installing front wheel, 120
 - Removing front wheel, 118
 - Removing rear wheel, 124
 - Technical data, 154

Details described or illustrated in this booklet may differ from the vehicle's actual specification as purchased, the accessories fitted or the national-market specification. No claims will be entertained as a result of such discrepancies.

Dimensions, weights, fuel consumption and performance data are quoted to the customary tolerances.

The right to modify designs, equipment and accessories is reserved.

Errors and omissions excepted.

© 2015 Bayerische Motoren Werke Aktiengesellschaft
80788 Munich, Germany
Not to be reproduced by any means whatsoever, wholly or in part, without the written permission of BMW Motorrad, After Sales.

Original rider's manual, printed in Germany.

