



**BMW
MOTORRAD**

RIDER'S MANUAL (US MODEL) CE 04



MAKE LIFE A RIDE

Vehicle data

Model

Vehicle identification number

Color number

First registration

License plate

Retailer data

Contact in Service

Ms./Mr.

Phone number

Retailer's address/Phone (company stamp)

YOUR BMW.

We are pleased that you have chosen a BMW Motorrad vehicle and welcome you to the family of BMW riders. Familiarize yourself with your new vehicle so that you can ride safely and confidently in all traffic situations.

About these operating instructions

Read these operating instructions before starting your new BMW. It contains important notes about operating the vehicle that will enable you to make full use of the technical assets of your BMW.

You will also obtain preventive maintenance and care instructions, which are beneficial to operating and road safety and help retain the value of your vehicle as much as possible.

If you should decide to sell your BMW one day, please remember to hand over these operating instructions as well. They are an important part of your vehicle.

We wish you many miles of safe and enjoyable riding with your BMW

BMW Motorrad.

01 GENERAL INSTRUCTIONS	2	04 OPERATION	52
Quick & easy reference	4	Standby	54
Abbreviations and symbols	4	Emergency-off switch	58
Equipment	5	Reversing	59
Technical data	6	Lighting	60
Currentness of this manual	6	Riding mode	62
Additional sources of information	6	Anti-theft alarm system (DWA)	63
Certificates and operating permits	7	Tire Pressure Monitor (TPM)	66
Data memory	7	Heating	66
		Storage compartment	67
		Helmet compartment	69
02 OVERVIEWS	12	05 TFT DISPLAY	72
Overall view, left side	14	General notes	74
Overall view, right side	15	Principle	75
Multifunction switch, left	16	Pure Ride view	81
Multifunction switch, right	17	Pure view	82
Instrument cluster	18	Split screen	82
		General settings	83
		Bluetooth®	85
		Wi-Fi	87
		My Vehicle	88
		Trip computer	91
03 DISPLAYS	20	Navigation	92
Indicator and warning lights	22	Media	94
TFT display in Pure Ride view	23	Telephone	95
TFT display in the Menu view	24	Displaying software version	96
TFT display in Charge view	25	Displaying license information	96
Indicator lights	26		

06 SETTING	98	09 TECHNOLOGY IN DETAIL	132
Mirrors	100	General notes	134
Headlights	100	Antilock braking system (ABS)	134
Spring preload	101	Traction control (ASC/DTC)	137
07 BMW EPOWER	104	Recuperation Stability Control (RSC)	139
Principle	106	Riding mode	139
General notes	106	Dynamic Brake Control	141
Charging cable	108	Tire Pressure Monitor (RDC)	142
Charging procedure	110	Adaptive headlight	143
08 RIDING	118	10 MAINTENANCE	146
Safety instructions	120	General notes	148
Observe checklist	121	Standard tool kit	149
Always before riding off	121	Brake system	149
At every 10th Charging procedure	122	Coolant	153
Establishing ride readiness	122	Tires	154
Riding the electric scooter	124	Rims and tires	155
Breaking in	127	Light sources	156
Brakes	127	Trim panel components	156
Parking the E-Scooter	128	Battery	158
Fastening the E-Scooter for transportation	129	Fuses	162
		Diagnostic socket	164
		11 ACCESSORIES	166
		General notes	168
		Sockets	168
		Topcase	169

12 CARE 174

Care products	176
Washing the vehicle	176
Cleaning sensitive vehicle parts	177
Care of paintwork	178
Paint preservation	179
Storing the E-Scooter	180
Putting the E-Scooter into operation	180

13 TECHNICAL DATA 182

Troubleshooting chart	184
Charging	187
Drivetrain	188
Transmission	188
Rear-wheel drive	188
Frame	188
Running gear	189
Brakes	189
Wheels and tires	190
Electrical system	191
Anti-theft alarm system	192
Dimensions	192
Weights	193
Performance data	193

14 SERVICE 194

Reporting safety defects	196
Recycling	197
BMW Motorrad Service	197

BMW Motorrad Service History	198
BMW Motorrad Mobility Services	198
Maintenance work	198
Maintenance schedule	200
BMW Motorrad break-in service	201
Maintenance confirmations	202
Service confirmations	214

APPENDIX 216

Certificate for electronic immobilizer	217
Certificate for Keyless Ride	220
Certificate for Keyless Ride	222
Certificate for Keyless Ride	224
Certificate for Keyless Ride	226
Certificate for Tire Pressure Monitor	228
Certificate for TFT instrument cluster	229

INDEX 234

GENERAL INSTRUCTIONS

01

QUICK & EASY REFERENCE	4
ABBREVIATIONS AND SYMBOLS	4
EQUIPMENT	5
TECHNICAL DATA	6
CURRENTNESS OF THIS MANUAL	6
ADDITIONAL SOURCES OF INFORMATION	6
CERTIFICATES AND OPERATING PERMITS	7
DATA MEMORY	7

4 GENERAL INSTRUCTIONS

QUICK & EASY REFERENCE

This rider's manual has been designed to provide quick and efficient orientation. The quickest way for you to find information on specific topics is to consult the comprehensive index at the end of the rider's manual. If you would like to start with a quick overview of your electric scooter, this information has been provided in chapter 2. All preventive maintenance and repair procedures carried out on your motorcycle will be documented in the "Service" chapter. Documentation of the maintenance work performed is a prerequisite for generous treatment of claims.





Warning signs on vehicle parts

The warning signs on vehicle parts inform you that the improper use of high-voltage technology or high-voltage

components could result in serious injury as a result of electric shock.

ABBREVIATIONS AND SYMBOLS

 **CAUTION** Hazard with low risk. Failure to avoid this hazard can result in minor or moderate injury.





 **WARNING** Hazard with moderate risk. Failure to avoid this hazard can result in death or serious injury.

 **DANGER** Hazard with high risk. Failure to avoid this hazard results in death or serious injury.

 **ATTENTION** Special instructions and precautionary measures. Non-compliance can cause damage to the vehicle or accessories and warranty claims may be denied as a result.

 Special information on operating and inspecting your motorcycle as well as maintenance and adjustment procedures.

- Instruction.
- » Result of a repair procedure.

	Reference to a page with more detailed information.
	Indicates the end of accessory or equipment-dependent information.
	Tightening torque.
	Technical data.
NV	National-market version.
OE	Optional equipment. BMW Motorrad optional equipment is already completely installed during motorcycle production.
OA	Optional accessories. BMW Motorrad optional accessories can be purchased and retrofitted at your authorized BMW Motorrad retailer.
ABS	Anti-Lock Brake System.
ASC	Automatic Stability Control.

DTC	Dynamic Traction Control.
DWA	Anti-theft alarm.
EWS	Electronic immobilizer.
TPC	Tire Pressure Control (TPC).
RSC	Recuperation Stability Control

EQUIPMENT

When you ordered your E-Scooter, you chose various custom equipment items. This Rider's Manual describes optional equipment (OE) offered by BMW and selected optional accessories (OA). This explains why the manual may also contain descriptions of equipment which you have not ordered. Please note, too, that your vehicle might not be exactly as illustrated in this manual on account of country-specific differences.

If your E-Scooter was supplied with equipment not described in this rider's manual, you will find these features described in a separate rider's manual.

6 GENERAL INSTRUCTIONS

TECHNICAL DATA

All dimensions, weights and performance data contained in this rider's manual refer to the German Institute for Standardization i.e. DIN (Deutsches Institut für Normung e. V.) and comply with their tolerance specifications.

The technical data and specifications in this rider's manual serve as points of reference.

The vehicle-specific data may vary, for instance due to the selected optional equipment, national-market version or country-specific measuring procedures. Detailed values can be obtained from the registration documents or requested from your BMW Motorrad retailer or other qualified service partner or repair shop. The information on the vehicle documents always takes precedence over the information in this rider's manual.

CURRENTNESS OF THIS MANUAL

The high BMW E-Scooter safety and quality level is maintained by consistent, ongoing development efforts in the design, equipment, and

accessories. For this reason, some aspects of your vehicle may vary from the descriptions in this rider's manual. In addition, BMW Motorrad cannot guarantee the total absence of errors. We hope you will appreciate that no claims can be recognized that are based on the data, illustrations or descriptions in this manual.

ADDITIONAL SOURCES OF INFORMATION

Authorized BMW Motorrad retailer

Your BMW Motorrad retailer is always happy to answer any of your questions.

Internet

The rider's manual for your vehicle, the operating and installation instructions for optional accessories and general BMW Motorrad information related to the technology or other features are available at bmw-motorrad.com/manuals.

CERTIFICATES AND OPERATING PERMITS

The certificates for the vehicle and the official operating permits for possible accessories are available at bmw-motorrad.com/certification.

DATA MEMORY

General information

Control units are installed in the vehicle. Control units process data received from vehicle sensors, self-generated data or data exchanged between control units, for example. Some control units are required for safe vehicle operation or provide riding assistance, such as rider assistance systems. Control units also make comfort and infotainment functions possible.

Information about the stored or exchanged data can be obtained from the vehicle manufacturer, such as in the form of a separate booklet.

Personal references

Every vehicle is marked with a unique vehicle identification number. Depending on the country, the vehicle owner can be identified using the

vehicle identification number and license plate and with the help of the relevant authorities. There are also other ways to trace data obtained from the vehicle back to the rider or vehicle owner, such as via the ConnectedDrive Account that was used.

Data privacy laws

In accordance with applicable data privacy laws, vehicle users have certain rights over the vehicle manufacturer or company that collects or processes personal data.

Vehicle users have the right to obtain comprehensive information without charge from the locations that store the vehicle user's personal data.

These locations may be:

- The vehicle manufacturer
- Qualified service partners
- Specialist workshops
- Service providers

Vehicle users may request information about the type of personal data that is stored, the purpose for which the data will be used and the source of the data. This information can only be obtained by a registered owner or a person with written

8 GENERAL INSTRUCTIONS

proof authorizing use of the vehicle.

The right to information also includes information related to data transmitted to other companies or locations.

The vehicle manufacturer's website contains the appropriate privacy policy notices. The privacy policy notices contain information on the right to delete or correct data. The vehicle manufacturer also provides the manufacturer contact information and the contact information of the data security officer on the Internet.

The vehicle owner can have a BMW Motorrad retailer or other qualified service partner or specialist workshop read out the data stored in the vehicle for a fee if required.

The vehicle data is read out via the vehicle's legally mandated diagnostic socket.

Legal requirements for the disclosure of data

The vehicle manufacture is required by the law applicable in this context to provide authorities with the data stored by the manufacturer. The provision of this data within the scope required is on a case-by-case

basis, for instance to clarify a criminal offense.

Government agencies are authorized by the law applicable in this context to read out the data from the vehicle themselves in individual cases.

Operating data in the vehicle

Control units process data so that the vehicle can run.

Examples of this include:

- Status messages from the vehicle and its individual components, such as wheel RPM, wheel centrifugal velocity and deceleration
- Ambient conditions, such as temperature

The data is processed only in the vehicle itself and is usually temporary. The data is not stored beyond the period in which the vehicle is operating. Electronic components such as control units contain components for storing technical information. This may be information about the vehicle's condition, component load, events or faults stored temporarily or permanently.

This information generally documents the condition of a component, module, system or the surrounding area; for example:

- Operating conditions of system components, such as fill levels and tire pressure
- Malfunctions and faults in key system components, such as lights and brakes
- Vehicle responses in specific riding situations, such as the activation of riding dynamics systems
- Information about events causing damage to the vehicle

The data is necessary for providing control unit functions. In addition, it is used by the vehicle manufacturer to detect and eliminate malfunctions as well as to optimize vehicle functions.

The majority of this data is temporary and is processed only within the vehicle itself. Only a small amount of event-driven data is stored in the event data recorder and fault memory.

When a vehicle is serviced, such as for repairs, servicing processes, warranty cases and quality assurance measures, this technical information can be read out from the vehicle together with the vehicle identification number.

The information can be read out by a BMW Motorrad retailer or other qualified service partner or specialist workshop. The vehicle's legally mandated diagnostic socket is used to read out the data.

The data is collected, processed and used by the respective service network locations. The data documents the vehicle's technical states and helps with fault finding, compliance with warranty obligations and quality improvements.

The manufacturer also has product monitoring obligations arising from product liability law. The vehicle manufacturer requires technical data from the vehicle in order to fulfill these obligations. The data from the vehicle can also be used to verify customer warranty and guarantee claims. The fault memory and event data recorder in the vehicle can be reset by a BMW Motorrad retailer or other qualified service partner or specialist workshop as part of a repair or servicing.

10 GENERAL INSTRUCTIONS

Data input and data transfer in the vehicle

General information

Depending on the equipment, comfort settings and individualized settings in the vehicle can be saved and changed or reset at any time.

It is possible to introduce data into the vehicle entertainment and communication system via a smartphone, for instance.

Depending on the individual equipment, this includes:

- Multimedia data, such as music for playback
- Address book data for use in combination with a communication system or integrated navigation system
- Entered destinations
- Data about the use of Internet services. This data can be stored locally in the vehicle or is on a device connected to the vehicle, such as a smartphone, USB stick or MP3 player. If this data is saved in the vehicle, it can be deleted at any time.

This data is transmitted to third parties only upon personal request as part of the use of online services. The data transmitted depends on the selected

settings when using the services.

Incorporating mobile end devices

Depending on the equipment, mobile end devices connected to the vehicle, such as smartphones, are controlled using the vehicle's operating elements.

This enables audio and visual output from mobile end devices through the multimedia system. At the same time, certain information is transmitted to the mobile end device. This includes, for instance, position data and other general vehicle information, depending on the type of incorporation, and makes it possible to optimize the use of selected apps, such as those for navigation or audio playback.

The way the data is processed further is determined by the provider of the particular app used. The range of possible settings depends on the particular app and the operating system of the mobile end device.

Services

General information

If the vehicle has a mobile phone connection, this connection makes it possible to exchange data between the vehicle and other systems. The mobile phone connection is made possible through the vehicle's transmitter and receiver or via personally integrated mobile end devices such as smartphones. Online functions, as they are called, are used over this mobile phone connection. These include online services and apps provided by the vehicle manufacturer or other providers.

Vehicle manufacturer services

In the case of the vehicle manufacturer's online services, the particular functions are described at the appropriate location, such as in the rider's manual or on the manufacturer's website. The relevant legal information on data privacy is also provided there. Personal data may be used in order to provide online services. The data is exchanged over a secure connection, i.e. with the vehicle manufacturer's IT sys-

tems which are intended for this purpose.

Any collection, processing and use of personal data that goes beyond the provision of services take place only as permitted by law, on the basis of a contractual agreement or as a result of consent. It is also possible to have the entire data connection activated or deactivated. This is not the case for legally prescribed functions.

Services of other providers

When using the online services of other providers, these services are subject to the responsibility and the term of data protection and use of the respective provider. The vehicle manufacturer has no control over the content exchanged via these services. Information about the type, scope and purpose of collecting and using personal data as part of third-party services can be obtained from the particular service provider.

OVERVIEWS

02

OVERALL VIEW, LEFT SIDE	14
OVERALL VIEW, RIGHT SIDE	15
MULTIFUNCTION SWITCH, LEFT	16
MULTIFUNCTION SWITCH, RIGHT	17
INSTRUMENT CLUSTER	18

14 OVERVIEWS

OVERALL VIEW, LEFT SIDE

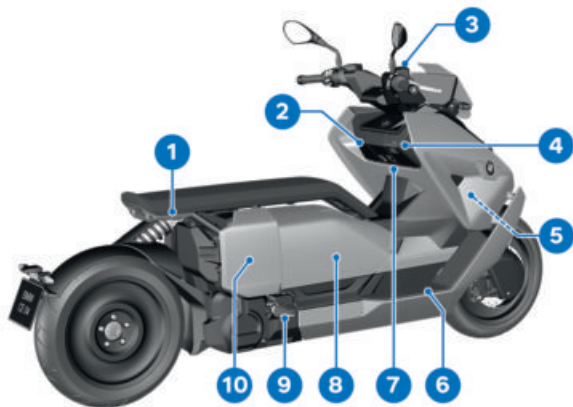

- | | |
|---|---------------------------------|
| <p>1 Behind the front-fairing panel:
Diagnostic connector (➡ 164)
Headlight range adjustment (➡ 100)
Coolant tank (➡ 153)
Onboard tool kit, Torx T25 (➡ 149)</p> <p>2 Brake fluid reservoir for the rear wheel brake (➡ 151)</p> <p>3 Passenger grab handle</p> <p>4 Adjust spring preload on the suspension strut (➡ 101)</p> <p>5 Passenger footrest</p> | <p>6 Rider footboard</p> |
|---|---------------------------------|

OVERALL VIEW, RIGHT SIDE

- | | |
|--|--|
| <p>1 Passenger grab handle</p> <p>2 Storage compartment
(➡ 67)</p> <p>3 Brake fluid reservoir for the front wheel brake
(➡ 151)</p> <p>4 Charging compartment
(➡ 111)</p> <p>5 Vehicle identification number (main frame, right front bottom)
Nameplate (frame, right front, at the steering head)</p> <p>6 Rider footboard</p> <p>7 12 V socket</p> | <p>8 Helmet compartment
(➡ 69)
Onboard vehicle tool kit for spring preload
(➡ 149)
Payload table and tire pressure table (on the inside of the helmet compartment flap)</p> <p>9 Passenger footrest</p> <p>10 Behind the side trim panel:
Battery (➡ 158)
Fuses (➡ 162)</p> |
|--|--|

16 OVERVIEWS

MULTIFUNCTION SWITCH, LEFT

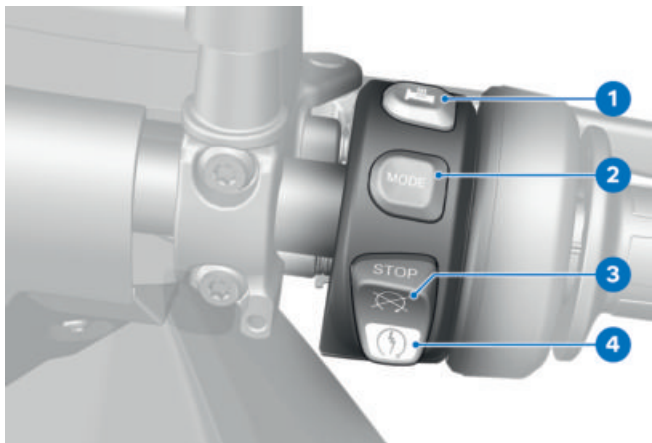

- 1 High beams and headlight flasher (☞ 60)
- 2 Hazard warning system (☞ 61)
- 3 Programmable memory buttons (☞ 81)
- 4 Reversing (☞ 59)
- 5 Turn signals (☞ 61)
- 6 Horn
- 7 MENU rocker button
- 8 Multi-Controller

MULTIFUNCTION SWITCH, RIGHT

- 1 Heating (➡ 66)
- 2 Riding mode (➡ 62)
- 3 Emergency-off switch (➡ 58)
- 4 Starter button (➡ 125)

18 OVERVIEWS

INSTRUMENT CLUSTER

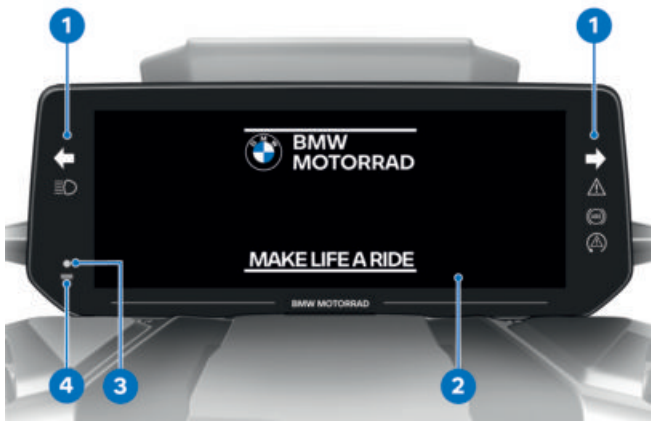

- 1 Indicator and warning lights (➡ 22)
- 2 TFT display (➡ 23) (➡ 24)
- 3 DWA LED
-with anti-theft alarm system (DWA)^{OE}
Alarm signal (➡ 63)
Indicator light for radio-operated key
Turn on standby mode. (➡ 54)
- 4 Photodiode (for adjusting brightness of instrument lighting)

DISPLAYS

03

INDICATOR AND WARNING LIGHTS	22
TFT DISPLAY IN PURE RIDE VIEW	23
TFT DISPLAY IN THE MENU VIEW	24
TFT DISPLAY IN CHARGE VIEW	25
INDICATOR LIGHTS	26



22 DISPLAYS

INDICATOR AND WARNING LIGHTS



- 1 Turn signal, left (➡ 61)
- 2 High beams (➡ 60)
- 3 General warning light (➡ 26)
- 4 Turn signal, right (➡ 61)
- 5 ASC (➡ 44)
—with riding modes Pro^{OE}
DTC (➡ 44)
- 6 ABS (➡ 50)

TFT DISPLAY IN PURE RIDE VIEW

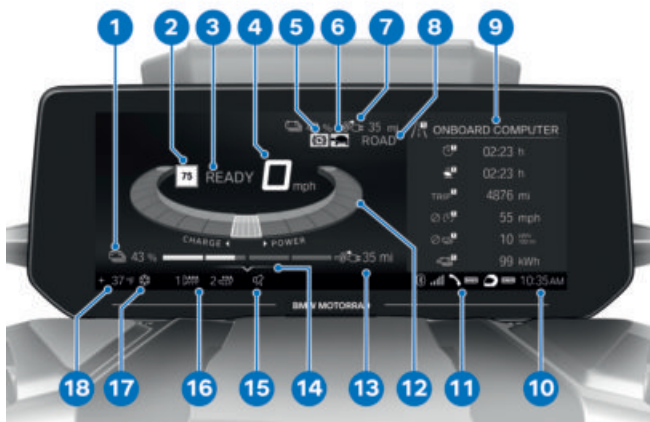

- | | |
|--|---|
| 1 Battery state of charge (➡ 82) | 12 Drive display (➡ 81) |
| 2 Speed Limit Info (➡ 80) | 13 Range (➡ 82) |
| 3 Ride readiness indicator (➡ 125) | 14 Operating assistance |
| 4 Speedometer | 15 Muting (➡ 83) |
| 5 Energy recovery limitation (➡ 81) | 16 Heating (➡ 66) |
| 6 Power limitation (➡ 81) | 17 External temperature warning (➡ 34) |
| 7 Rider info. status line (➡ 79) | 18 Outside temperature |
| 8 Riding mode (➡ 62) | |
| 9 Split screen (➡ 82) | |
| 10 Clock (➡ 83) | |
| 11 Connection status (➡ 86) | |

24 DISPLAYS

TFT DISPLAY IN THE MENU VIEW

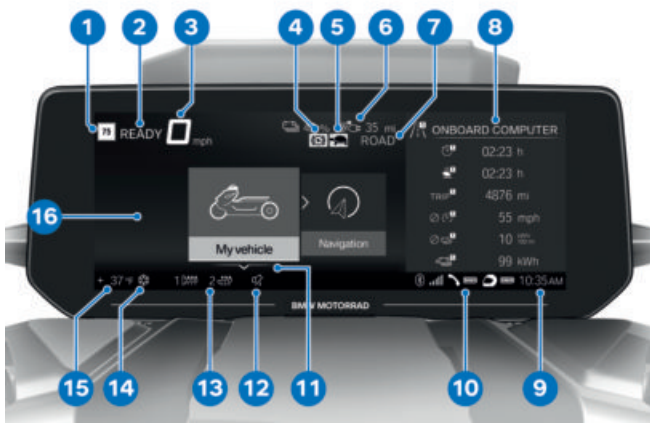

- | | |
|--|---|
| 1 Speed Limit Info (►► 80) | 12 Muting (►► 83) |
| 2 Ride readiness indicator
Turn on ride readiness.
(►► 125) | 13 Heating (►► 66) |
| 3 Speedometer | 14 External temperature
warning (►► 34) |
| 4 Energy recovery limitation
(►► 81) | 15 Outside temperature |
| 5 Power limitation (►► 81) | 16 Menu area |
| 6 Rider info. status line
(►► 79) | |
| 7 Riding mode (►► 62) | |
| 8 Split screen (►► 82) | |
| 9 Clock (►► 83) | |
| 10 Connection status
(►► 86) | |
| 11 Operating assistance | |

TFT DISPLAY IN CHARGE VIEW

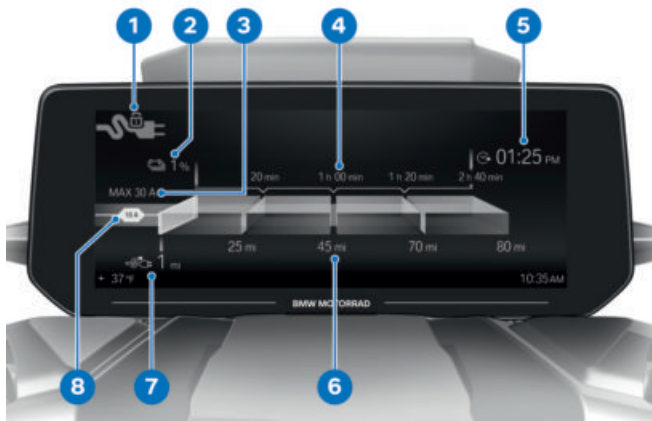

- 1 Status of charging plug
- 2 State of charge
- 3 Maximum available charge current level
- 4 Charging time prediction
- 5 Target time for 100% charging process
- 6 Range prediction
- 7 Range
- 8 Active charging current limit

26 DISPLAYS

INDICATOR LIGHTS

Layout

Warnings are indicated by the corresponding warning light. Warnings are indicated by the general warning light in combination with a dialog in the TFT display. The general warning light lights up in either yellow or red, depending on the urgency of the warning.

 The general warning light lights up for whichever warning is most urgent at the current time.

You will find an overview of the potential warnings on the following pages.



Check Control display

The messages in the display are shown differently in the display. Different colors and characters are used depending on the priority:

- Green CHECK OK **1**: No message, optimal values.
- White circle with lowercase "i" **2**: information.
- Yellow warning triangle **3**: warning, value not optimal.
- Red warning triangle **3**: warning, value critical



Value display

The icons **4** are displayed differently. Different colors are used depending on the assessment of value. Instead of numerical values **8** with units **7**, texts **6** are also displayed:

Color of the icon

- Green: (OK) Current value is optimal.
- Blue: (Cold!) Current temperature is low.
- Yellow: (Low!/High!) Current value is too low or too high.
- Red: (Hot!/High!) Current temperature or value is too high.

–White: (---) There is no valid value. Instead of the value, dashes **5** are displayed.

 The evaluation of the individual values is possible in part only after a certain riding duration or speed. If a measured value cannot yet be displayed due to unfulfilled measurement conditions, dashes are displayed instead as placeholders. As long as no valid measured value is available, no evaluation is carried out in the form of a colored symbol.

- If the icon **2** is active, you can acknowledge this by tilting the Multi-Controller to the left.
- Check Control messages are dynamically added to the screens in the *My vehicle* menu as additional tabs ( 77). You can go back to the message as long as the fault is present.

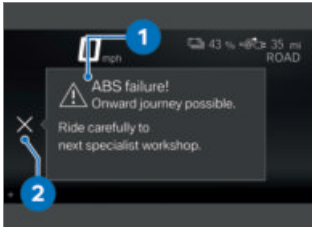

















Check Control dialog



















Messages are output as Check Control dialog **1**.

- If several Check Control messages of the same priority are present, the messages change in the order in which they occur, until they are acknowledged.



















28 DISPLAYS





















Overview of warning indicators

Indicator and warning lights	Display text	Meaning
	 is displayed.	External temperature warning (▬▬▬▬▶▶▶▶ 34)
 is lit yellow.	 Remote key not in range.	Radio-operated key outside reception range (▬▬▬▬▶▶▶▶ 34)
 is lit yellow.	 Keyless Ride failure!	Keyless Ride malfunction (▬▬▬▬▶▶▶▶ 35)
 is lit yellow.	 Remote key battery at 50%.	Replacing the battery of the radio-operated key
	 Remote key battery low.	(▬▬▬▬▶▶▶▶ 35)
 is lit yellow.	 The faulty light source is displayed.	Faulty light source (▬▬▬▬▶▶▶▶ 35)
 is lit yellow.	 Light control failure!	Light control unit failed (▬▬▬▬▶▶▶▶ 36)
	 Anti-theft alarm batt. capacity low.	Anti-theft alarm system battery is weak (▬▬▬▬▶▶▶▶ 37)
	 Anti-theft alarm battery discharged.	Anti-theft alarm system battery discharged (▬▬▬▬▶▶▶▶ 37)
	 Anti-theft alarm system failure.	DWA malfunction (▬▬▬▬▶▶▶▶ 37)
 is lit yellow.	 No communication with drive electronics.	Communication fault in the EME (▬▬▬▬▶▶▶▶ 37)































Indicator and warning lights	Display text	Meaning
 lights up.		Communication fault in the EME (▣▣▣ 37)
 is lit yellow.	 Insulation fault in high-voltage system.	Insulation fault in the high-voltage system (▣▣▣ 38)
 is lit red.	 Insulation fault in high-voltage system.	Severe insulation fault in the high-voltage system (▣▣▣ 38)
	 Charge level low.	Low state of charge (▣▣▣ 38)
 is lit yellow.	 Charge level critical.	Critical state of charge (▣▣▣ 39)
	 lights up.	
 is lit yellow.	 Fault in E-drive: Output reduced.	Fault in the electric drive: Output reduced (▣▣▣ 39)
	 lights up.	
 is lit yellow.	 Fault in electric drive.	High-voltage system cannot be switched on in addition or switched off (▣▣▣ 39)
 is lit yellow.	 Fault in the electric drive.	Fault in electric drive (▣▣▣ 39)
 is lit yellow.	 Connector lock faulty.	Connector fastener fault (▣▣▣ 40)





30 DISPLAYS

Indicator and warning lights	Display text	Meaning
 blinks red.	 Serious fault in electric drive!	Severe fault in electric drive (▬▬▬ 40)
 is lit yellow.	 Drive system too hot: Power reduced.	Drive too hot (▬▬▬ 40)
 is lit yellow.	 Charging interruption, charg.sys. overheated.	Charging system overheated (▬▬▬ 41)
 is lit yellow.	 Energy recovery limited.	Energy recovery limited (▬▬▬ 41)
	 lights up.	
 is lit yellow.	 High-voltage safety plug disconnected.	High-voltage safety plug disconnected (▬▬▬ 41)
	 Chg.target not reached. Chg.power reduced	Reduced charging capacity (▬▬▬ 41)
 is lit yellow.	 Fault in the charging infrastructure.	Fault in charging infrastructure (▬▬▬ 42)
 is lit yellow.	 Fault in charging sys.	Fault in the charging system (▬▬▬ 42)
 is lit yellow.	 On-board battery state.	State of vehicle battery (12 V battery) (▬▬▬ 43)

Indicator and warning lights	Display text	Meaning
 is lit yellow.	 is displayed in yellow.	Voltage of the vehicle electrical system low (▣▣▣ 43)
	 Vehicle voltage low.	
 is lit yellow.	 is displayed in yellow.	Voltage of the vehicle electrical system is critical (▣▣▣ 43)
	 Vehicle voltage critical!	
 blinks rapidly.		ASC/DTC intervention (▣▣▣ 44)
 is lit yellow.	 Traction control limited.	Limited ASC/DTC availability (▣▣▣ 44)
 lights up.		
 is lit yellow.	 Traction control systems failed!	ASC/DTC malfunction (▣▣▣ 44)
 lights up.		
 is lit yellow.	 is displayed in yellow.	Tire pressure is the limit range of approved tolerance (▣▣▣ 46)
	 Tire pressure not at set-point.	
 blinks red.	 is displayed in red.	Tire pressure is outside the approved tolerance range (▣▣▣ 46)
	 Tire pressure not at set-point.	
	 Tire Press. Monitor. Loss of pressure.	

32 DISPLAYS

Indicator and warning lights	Display text	Meaning
	 "----"	Transmission fault ( 47)
 is lit yellow.	 "----"	Sensor faulty or system fault ( 48)
 is lit yellow.	 TPM sensors battery low.	Battery of the tire pressure sensor weak ( 48)
 is lit yellow.	 Tire Press. Monitor failure!	Tire Pressure Monitor (TPM) malfunction ( 48)
 is lit yellow.	 Side stand monitoring defective.	Side stand monitoring faulty ( 49)
 flashes regularly.		ABS self-diagnosis not completed ( 49)
 is lit yellow.	 Limited ABS availability!	ABS fault ( 49)
 lights up.		
 is lit yellow.	 ABS failure!	ABS failure ( 50)
 lights up.		
 is lit yellow.	 ABS Pro failure!	ABS Pro failure ( 50)
 lights up.		
	 is displayed in white.	Service due ( 51)

Indicator and warning lights	Display text	Meaning
	Service due!	Service due ( 51)
 is lit yellow.	 is displayed in yellow.	Service appointment overdue
	Service overdue!	( 51)

34 DISPLAYS

Outside temperature

The outside temperature is displayed in the status line of the TFT display.

Engine heat can lead to spurious measurement readings of the outside temperature when the vehicle is stationary. If the effect of the motor heat becomes excessive, dashes are temporarily displayed instead of the value.



If the outside temperature falls below the limit value of Approx. 37 °F (Approx. 3 °C), there is a risk of black ice formation.

The first time the temperature drops below this value, the outside temperature display and ice crystal symbol will blink in the status line of the TFT display.

External temperature warning



is displayed.

Possible cause:



The outside temperature measured on the vehicle is less than:

Approx. 37 °F (Approx. 3 °C)



WARNING

Risk of black ice, even above Approx. 37 °F (Approx. 3 °C)

Risk of accident

- At a low outside temperature, icy conditions must be expected on bridges and in shady road areas.

- Use caution when riding.

Radio-operated key outside reception range



is lit yellow.



Remote key not in range. It is not possible to turn on the ignition again.

Possible cause:

The communication between the radio-operated key and the engine electronics is faulty.

- Check the battery in the radio-operated key.
- Replace the battery of the radio-operated key. (► 57)
- Use the spare key for further travel.
- Battery of radio-operated key is dead or radio-operated key is lost. (► 56)
- If the Check Control dialog appears while riding, remain

calm. You can continue riding; the ride readiness will not turn off.

- Have any faulty radio-operated keys replaced by a BMW Motorrad retailer.

Keyless Ride malfunction



is lit yellow.



Keyless Ride failure! Do not stop engine. Engine restart may not be possible.

Possible cause:

The Keyless Ride control unit has diagnosed a communication fault.

- Do not turn off ride readiness. Visit a repair shop immediately if possible, ideally an authorized BMW Motorrad retailer.
- » Ride readiness can no longer be turned on using Keyless Ride.
- » DWA can no longer be activated.

Replacing the battery of the radio-operated key



is lit yellow.



Remote key battery at 50%. No functional limitation.



Remote key battery low. Function limited. Change battery.

Possible cause:

- The battery for the radio-operated key is no longer charged to full capacity. Operation of the radio-operated key is only ensured for a limited time.
- Replace the battery of the radio-operated key. (→ 57)

Faulty light source



is lit yellow.



The faulty light source is displayed:



High beam faulty!



Turn indicator front left faulty! or Turn indicator front right faulty!



Low beam faulty!



Front parking lamp faulty!





Tail light faulty!



Brake light faulty!

36 DISPLAYS

 Rear left turn signal faulty! or Rear right turn signal faulty!

 License plate light faulty!

–Have checked by a specialist workshop.

WARNING

Overlooking the vehicle in traffic due to a defective light source on the vehicle

Safety risk

- Replace defective bulbs as soon as possible; it is best always to carry a complete set of spare bulbs on the motorcycle.

Possible cause:

One or more light sources are faulty.

- Locate defective bulb with visual check.
- Have the LED light source replaced in full; for details please contact a specialist workshop, preferably an authorized BMW Motorrad retailer.

Light control unit failed

 is lit yellow.

 Light control failure! Have checked by a specialist workshop.

WARNING

Overlooking the vehicle in traffic due to failure of the vehicle lighting

Safety risk

- Have the malfunction corrected as soon as possible at a specialist workshop, preferably an authorized BMW Motorrad retailer.

The vehicle lighting has failed partially or completely.

Possible cause:

The light control unit has diagnosed a communication error.

- Have the malfunction corrected as soon as possible at a specialist workshop, preferably an authorized BMW Motorrad retailer.

Anti-theft alarm system battery is weak

—with anti-theft alarm system (DWA)^{OE}

 Anti-theft alarm batt. capacity low. No limitations. Arrange an appointment at a specialist workshop.

 This fault message is only shown for a short time immediately following the Pre-Ride-Check.

Possible cause:

The DWA battery no longer has its full capacity. The operation of the anti-theft alarm system is only ensured for a limited time with the vehicle battery disconnected.

- Contact a specialist workshop, preferably an authorized BMW Motorrad retailer.

Anti-theft alarm system battery discharged

—with anti-theft alarm system (DWA)^{OE}

 Anti-theft alarm battery discharged. No independent alarm. Arrange an appointment at a specialist workshop.

 This fault message is only shown for a short time immediately following the Pre-Ride-Check.

Possible cause:

The anti-theft alarm system battery is completely discharged. Operation of the anti-theft alarm system is no longer ensured when the vehicle battery is disconnected.

- Contact a specialist workshop, preferably an authorized BMW Motorrad retailer.

DWA malfunction

 Anti-theft alarm system failure. Have checked by a specialist workshop.

Possible cause:

The DWA control unit has diagnosed a communication fault.

- Contact a specialist workshop, preferably an authorized BMW Motorrad retailer.
- » DWA can no longer be activated or deactivated.
- » False alarm possible.

Communication fault in the EME

 is lit yellow.

38 DISPLAYS

 lights up.

 No communication with drive electronics. Multiple systems affected. Have vehicle checked by a specialist workshop.

Possible cause:

The electrical machine electronics have diagnosed a communication fault.

- Have the malfunction corrected as soon as possible at a repair shop, preferably an authorized BMW Motorrad retailer.

Insulation fault in the high-voltage system

 is lit yellow.

 Insulation fault in high-voltage system. Mod. continuation possible. Drive carefully to the nearest workshop.

Possible cause:

An isolation fault has been detected. A high-voltage cable or a high-voltage component has been damaged.

- Modifications and work on the high-voltage system should only be performed by

an authorized BMW Motorrad retailer with appropriately trained staff.

Severe insulation fault in the high-voltage system

 is lit red.

 Insulation fault in high-voltage system. New start after engine stop not possible. Visit workshop immediately.

Possible cause:

A severe insulation fault has been detected. A high-voltage cable or a high-voltage component has been damaged. After the end of the ride, the vehicle cannot be restarted. Damage to the vehicle can be the result.

- Immediately contact an authorized BMW Motorrad retailer with appropriately trained staff.

Low state of charge

 Charge level low. Go to charging station.

Possible cause:

The state of charge of the vehicle is low.

- Ride up to the charging station and charge the vehicle.

Critical state of charge

is lit yellow.



Charge level critical. Power reduced. Go to charging station.



lights up.

**WARNING****Unusual handling when the electric drive is in emergency operation**

Accident hazard

- Avoid rapid acceleration and passing maneuvers.

**Fault in the electric drive:
Output reduced**

is lit yellow.



Fault in E-drive: Output reduced. Mod. continuation possible. Drive carefully to the nearest workshop.



lights up.

**WARNING****Unusual handling when the electric drive is in emergency operation**

Accident hazard

- Avoid rapid acceleration and passing maneuvers.

Contact a repair shop, preferably an authorized BMW Motorrad retailer.

High-voltage system cannot be switched on in addition or switched off

is lit yellow.



Fault in electric drive. Have vehicle checked by a specialist workshop.

Possible cause:

The high-voltage system cannot be switched on in addition or switched off

- Contact a specialist workshop, preferably an authorized BMW Motorrad retailer.

Fault in electric drive

is lit yellow.



Fault in the electric drive. Limited onward journey possible.

40 DISPLAYS

Drive carefully to the nearest workshop.

Contact a repair shop, preferably an authorized BMW Motorrad retailer.

Connector fastener fault



is lit yellow.



Connector lock faulty. Reconnect cable. If this happens again, contact a specialist workshop.

Possible cause:

Charging cable cannot be unlocked.

- Perform emergency release of charging plug. (▣▣▣ 116)

Possible cause:

Charging cable cannot be locked.

- Insert cable completely.
- If the fault persists, contact a specialist workshop, preferably an authorized BMW Motorrad retailer.

Severe fault in electric drive



blinks red.



Serious fault in electric drive! Stop immediately! Have vehicle checked by a specialist workshop.

Possible cause:

A severe fault was detected in the electric drive. Irregular vehicle handling may occur. Continued riding can result in damage to the vehicle.

- Stop immediately.
- Contact a repair shop, preferably an authorized BMW Motorrad retailer.

Drive too hot



is lit yellow.



Drive system too hot: Power reduced. Limited onward journey possible.

Possible cause:

Coolant level is too low.

- Check the coolant level. (▣▣▣ 153)

If coolant level is too low:

- Let cool down drivetrain and cooling system.
- Topping up coolant (▣▣▣ 153).
- If this occurs repeatedly, have the cooling system checked at a specialist workshop, preferably by an authorized BMW Motorrad retailer.

Possible cause:

A high temperature in the drivetrain or cooling system was detected.

- Ride in the partial load range if possible to cool the drivetrain.
- If the drive system temperature is frequently too high, have the fault rectified as quickly as possible by a specialist workshop, preferably an authorized BMW Motorrad retailer.

Charging system overheated



is lit yellow.



Charging interruption, charg.sys. overheated. Check coolant level. If this happens again, have checked by workshop.

Possible cause:

Coolant level is too low.

- Check the coolant level. (▣▣▣▣▶ 153)
- If coolant level is too low:
- Let cool down drivetrain and cooling system.
 - Topping up coolant (▣▣▣▣▶ 153).
 - If this occurs repeatedly, have the cooling system checked at a specialist workshop,

preferably by an authorized BMW Motorrad retailer.

Energy recovery limited



is lit yellow.



Energy recovery limited. Lim.onward journey possible. Drive carefully to the nearest specialist workshop.



lights up.

Contact a repair shop, preferably an authorized BMW Motorrad retailer.

High-voltage safety plug disconnected



is lit yellow.



High-voltage safety plug disconnected. Not ready to ride. Have vehicle checked by a specialist workshop.

Contact a repair shop, preferably an authorized BMW Motorrad retailer.

Reduced charging capacity



Chg.target not reached. Chg.power reduced Check charge level. More information in the Owner's Manual.

42 DISPLAYS

Possible cause:

The vehicle does not charge at full power.

- Check temperature, charging infrastructure and charging cable.

Possible cause:

The charging process was canceled at a state of charge below 90%.

- Check state of charge.

Fault in charging infrastructure



is lit yellow.



Fault in the charging infrastructure. Check the charging cable and mains connection or use another mains connection.

Possible cause:

Due to a fault in the charging infrastructure, the charging operation has been aborted or the charging operation could not be started.

- Check charging cable and power connection; use different power connection if available.

Fault in the charging system



is lit yellow.



Fault in charging sys. Charging not possible. Drive carefully to nearest specialist workshop.

Possible cause:

Due to a fault in the vehicle, the charging operation has been aborted or the charging operation could not be started. The DC/DC converter is faulty.

- Turn on standby mode.
- Detach the charging cable.
- Wait two minutes.
- » Vehicle has gone to sleep.
- Turn off standby mode.
- Plug in charging cable.
- » New attempt at charging operation is started.
- If this occurs again, contact a specialist workshop, preferably an authorized BMW Motorrad retailer.

Possible cause:

If the fault occurs while the vehicle is in motion: The DC/DC converter is faulty, and the 12 V battery cannot be recharged.

- Have the malfunction corrected as soon as possible at a specialist workshop,

preferably an authorized BMW Motorrad retailer.

- » Continued riding is possible until the battery is completely discharged, however it is not recommended.

State of vehicle battery (12 V battery)



is lit yellow.



On-board battery state. No restrictions. Have battery checked by a specialist workshop.

Possible cause:

The vehicle battery cannot sustain the voltage any longer and should be replaced as soon as possible.

- Contact a specialist workshop, preferably an authorized BMW Motorrad retailer.

Voltage of the vehicle electrical system low



is lit yellow.



is displayed in yellow.



Vehicle voltage low. Switch off unneeded consumers.

Possible cause:

Too many electrical consumers are turned on.

- Charge 12 V battery. (►► 159)

If the 12 V battery is no longer fully charging:

- Contact a specialist workshop, preferably an authorized BMW Motorrad retailer.

Voltage of the vehicle electrical system is critical



is lit yellow.



is displayed in yellow.



Vehicle voltage critical! Consumers were switched off Check battery condition. or Battery is not charged. Check battery condition.

12 V battery no longer has sufficient voltage to supply all components.

Possible cause:

Too many electrical consumers are turned on.

- Charge 12 V battery. (►► 159)

If the 12 V battery is no longer fully charging:

- Contact a specialist workshop, preferably an authorized BMW Motorrad retailer.

44 DISPLAYS

ASC/DTC intervention



blinks rapidly.

Possible cause:

ASC/DTC has detected instability at the rear wheel and responded by reducing the torque.

The indicator and warning light flashes longer than the ASC/DTC intervention lasts. This provides the rider with visual feedback for the control action that was taken even after the critical riding situation has passed.

- You may continue riding. Use caution when riding.

Limited ASC/DTC availability



is lit yellow.



lights up.



Traction control limited. Onward journey possible.

Ride carefully to next specialist workshop.

Possible cause:

The ASC/DTC control unit has detected a fault.

- Note that the ASC/DTC function is available with limitations only.

- You may continue riding. Observe additional information on situations that can lead to an ASC/DTC fault (▣▣▣ 137).
- Have the malfunction corrected as soon as possible at a specialist workshop, preferably an authorized BMW Motorrad retailer.

ASC/DTC malfunction



is lit yellow.



lights up.



Traction control systems failed! Limited onward journey possible. Drive carefully to the nearest workshop.

Possible cause:

The ASC/DTC control unit has detected a fault.

- Do not damage the angular rate sensor.
- It must be noted that the ASC/DTC function is not available at all or is restricted.
- You may continue riding. Observe additional information on situations that can lead to an ASC/DTC fault (▣▣▣ 137).
- Have the malfunction corrected as soon as possible at a specialist workshop,

preferably an authorized BMW Motorrad retailer.

Tire pressure

—with tire pressure monitor (TPM)^{OE}

In addition to the MY VEHICLE menu screen and the Check Control messages, there is also the TIRE PRESSURE screen to display the tire pressures:



The values on the left refer to the front wheel, and the values on the right refer to the rear wheel.

The pressure differential is indicated by the current and set-point tire pressure.

Immediately after standby mode is turned on, only dashes are displayed. The transmission of the tire pressure values does not begin until the following minimum speed is exceeded for the first time:



RDC sensor is not active

min 19 mph (min 30 km/h)
(The RDC sensor transmits its signal to the vehicle only once the minimum speed has been exceeded.)



The tire pressures are shown in the TFT display with temperature compensation and are always based on the following tire air temperature:

68 °F (20 °C)



If the tire icon appears yellow or red at the same time, the display is a warning. The pressure differential is highlighted with an exclamation mark of the same color.



If the value in question is within the limit range of the permitted tolerance, the general warning light also lights up yellow.



If the determined tire pressure is outside the permitted tolerance, the general warning light blinks red.

46 DISPLAYS

For more information about the BMW Motorrad TPM, see the "Technology in detail" chapter starting on page (▣▣▣ 142).

Tire pressure is the limit range of approved tolerance



is lit yellow.



is displayed in yellow.



Tire pressure not at setpoint. Check tire pressure.

Possible cause:

The measured tire pressure is within the limit range of the permissible tolerance.

- Correct the tire pressure.
- Before adjusting the tire pressure, check the information on temperature compensation and tire pressure adjustment in the chapter "Technology in detail":

–with tire pressure monitor (TPM)^{OE}

» Temperature compensation (▣▣▣ 143)◁

–with tire pressure monitor (TPM)^{OE}

» Tire pressure adjustment (▣▣▣ 143)◁

» The target tire pressures can be found in the following locations:

–On the back cover of the Rider's Manual

–Instrument cluster in the TIRE PRESSURE view

–Sign on the inside of the helmet compartment flap

Tire pressure is outside the approved tolerance range



blinks red.



is displayed in red.



Tire pressure not at setpoint. Stop immediately! Check tire pressure.



Tire Press. Monitor. Loss of pressure. Stop immediately! Check tire pressure.



WARNING

Tire pressure is outside the approved tolerance range.

Risk of accident, deterioration in the handling characteristics of the vehicle.

- Adjust the driving style.

Possible cause:

The measured tire pressure is outside of the permissible tolerance.

- Check tire for damage and handling.

If the tire can still be handled:

- Correct the tire pressure at the next opportunity.
- Before adjusting the tire pressure, check the information on temperature compensation and tire pressure adjustment in the chapter "Technology in detail":

–with tire pressure monitor (TPM)^{OE}

» Temperature compensation (▣▣▣▣ 143)◁

–with tire pressure monitor (TPM)^{OE}

» Tire pressure adjustment (▣▣▣▣ 143)◁

» The target tire pressures can be found in the following locations:

–On the back cover of the Rider's Manual

–Instrument cluster in the **TIRE PRESSURE** view

- Have the tire checked by a specialist workshop for damage, preferably by an authorized BMW Motorrad retailer.

If you are unsure whether the tire is rideable:

- Do not continue riding.
- Contact roadside service.

Transmission fault

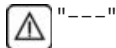

Possible cause:

The vehicle has not reached the minimum speed (▣▣▣▣ 142).



RDC sensor is not active

min 19 mph (min 30 km/h)
(The RDC sensor transmits its signal to the vehicle only once the minimum speed has been exceeded.)

- Observe the TPM display at higher speed.



This is a permanent fault only when the general warning light also lights up. In this case:

- Have the malfunction corrected at a specialist workshop, preferably an authorized BMW Motorrad retailer.

Possible cause:

The radio link to the TPM sensors is disrupted. There are radio installations in the surrounding area that are causing interference to the connection between the TPM and the sensors.

48 DISPLAYS

- Observe the TPM display in different surroundings.

 This is a permanent fault only when the general warning light also lights up. In this case:

- Have the malfunction corrected at a specialist workshop, preferably an authorized BMW Motorrad retailer.

Sensor faulty or system fault

 is lit yellow.

 "----"

Possible cause:

Wheels without TPM sensors are installed.

- Retrofit wheel set with TPM sensors.

Possible cause:

1 or 2 TPM sensors have malfunctioned or there is a system fault.

- Have the malfunction corrected at a specialist workshop, preferably an authorized BMW Motorrad retailer.

Battery of the tire pressure sensor weak

 is lit yellow.

 TPM sensors battery low. Function limited. Have checked by a specialist workshop.

 This fault message is only shown for a short time immediately following the Pre-Ride-Check.

Possible cause:

The battery for the tire pressure sensor is no longer charged to full capacity.

Operation of the RDC is only ensured for a limited time.

- Contact a specialist workshop, preferably an authorized BMW Motorrad retailer.

Tire Pressure Monitor (TPM) malfunction

—with tire pressure monitor (TPM)^{OE}

 is lit yellow.

 Tire Press. Monitor failure! Function limited. Have checked by a specialist workshop.

Possible cause:

The TPM control unit has diagnosed a communication fault.

- Contact a specialist workshop, preferably an authorized BMW Motorrad retailer.

» Tire pressure warnings not available.

Side stand monitoring faulty



is lit yellow.



Side stand monitoring defective. Engine stop at low speed! Have checked by a specialist workshop.

Possible cause:

The side support switch or its wiring is damaged. The electrical machine is switched off when the speed falls below 3mph (5 km/h), and the ride cannot be resumed.

- Contact a specialist workshop, preferably an authorized BMW Motorrad retailer.

ABS self-diagnosis not completed



blinks.

Possible cause:



ABS self-diagnosis not completed

The ABS function is not available, as the self-diagnosis function has not been completed. (The E-Scooter must reach a specified minimum speed before the system can check operation of the wheel speed sensors: min 3 mph (min 5 km/h))

- Ride off slowly. Please note that the ABS function is only available after the self-diagnosis has completed.

ABS fault



is lit yellow.



lights up.



Limited ABS availability! Onward journey possible. Ride carefully to next specialist workshop.

Possible cause:

The ABS control unit has detected an error. The ABS function is limited.

- You may continue riding. Take note of additional information on special situations that can lead to

50 DISPLAYS

an ABS fault memory entry (▣▶ 135).

- Have the malfunction corrected as soon as possible at a specialist workshop, preferably an authorized BMW Motorrad retailer.

ABS failure

 is lit yellow.

 lights up.

 ABS failure! Onward journey possible.

Ride carefully to next specialist workshop.

Possible cause:

The ABS control unit has detected an error. The ABS function is not available.

- You may continue riding. Take note of additional information on special situations that can lead to an ABS fault memory entry (▣▶ 135).
- Have the malfunction corrected as soon as possible at a specialist workshop, preferably an authorized BMW Motorrad retailer.

ABS Pro failure

 is lit yellow.

 lights up.

 ABS Pro failure! Onward journey possible. Ride carefully to next specialist workshop.

Possible cause:

—with riding modes Pro^{OE}

The ABS Pro control unit has detected a fault. The ABS Pro function is not available. The ABS function remains available. ABS only supports braking in straight-ahead riding.

- You may continue riding. Take note of additional information on special situations which can lead to an ABS Pro fault memory entry (▣▶ 135).
- Have the malfunction corrected as soon as possible at a specialist workshop, preferably an authorized BMW Motorrad retailer.

Service display

 If service is overdue, the service date or the distance covered at which service should have been completed

is accompanied by the general warning light in yellow.

If service is overdue, a yellow Check Control message is displayed. The displays for service, service appointment, and remaining distance are also highlighted with exclamation marks in the menu windows MY VEHICLE and SERVICE REQUIREMENTS.

 If the service display appears more than a month before the service date, the current day's date must be reset in the instrument cluster. This situation can occur if the battery was disconnected.

Service due



is displayed in white.

Service due! Have a service performed at a specialist workshop.
Possible cause:

Service is due because of the mileage or the date.

- Have service performed regularly by a specialist workshop, preferably an authorized BMW Motorrad retailer.
- » The operating safety and road safety of the vehicle remains unchanged.

» The best-possible value retention of the vehicle is ensured.

Service appointment overdue



is lit yellow.



is displayed in yellow.

Service overdue! Have a service performed at a specialist workshop.

Possible cause:

Service is overdue because of the riding performance or the date.

- Have service performed regularly by a specialist workshop, preferably an authorized BMW Motorrad retailer.
- » The operating safety and road safety of the vehicle remains unchanged.
- » The best-possible value retention of the vehicle is ensured.

OPERATION

04

STANDBY	54
EMERGENCY-OFF SWITCH	58
REVERSING	59
LIGHTING	60
RIDING MODE	62
ANTI-THEFT ALARM SYSTEM (DWA)	63
TIRE PRESSURE MONITOR (TPM)	66
HEATING	66
STORAGE COMPARTMENT	67
HELMET COMPARTMENT	69



- There are **two** variants for turning on standby mode.

Version 1:

- Briefly press button **1**.
 - » Parking lights and all function circuits are turned on.
 - » Pre-Ride-Check is carried out. (▮▮▮▮ 122)
 - » ABS self-diagnosis is performed. (▮▮▮▮ 123)

Version 2:

- Steering lock is locked; press and hold button **1**.
 - » Steering lock is unlocked.
 - » Parking lights and all function circuits turned on.
 - » Pre-Ride-Check is carried out. (▮▮▮▮ 122)
 - » ABS self-diagnosis is performed. (▮▮▮▮ 123)

Standby turned off Requirement

Radio-operated key is within reception area.



- There are **two** variants for turning off standby mode.

Version 1:

- Briefly press button **1**.
 - » Light is turned off.
 - » Steering lock is not locked.

Version 2:

- Turn handlebars to left.
- Press and hold button **1**.
 - » Light is turned off.
 - » Steering lock is locked.

Electronic immobilizer EWS

The electric scooter's electronics monitor the data stored in the ignition key through a ring antenna incorporated in the vehicle lock. The engine control unit does not enable ride readiness until this key has been recognized as "authorized".



An additional radio-operated key fastened to the same ring as the radio-operated key used to start the engine could confuse the electronics, in which case the en-

56 OPERATION

abling signal for ride readiness is not issued.

Always keep the radio-operated keys separate from each other.

If you lose an ignition key, you can have it disabled by your authorized BMW Motorrad retailer.

For this purpose, you should also bring all of the electric scooter's remaining ignition keys with you. The electrical machine can no longer be started by a disabled vehicle key; however, a disabled vehicle key can be enabled again. Spare keys are available only through an authorized BMW Motorrad retailer. The vehicle keys are part of an integrated safety system, so the retailer is under obligation to check the legitimacy of all applications for spare keys.

Battery of radio-operated key is dead or radio-operated key is lost

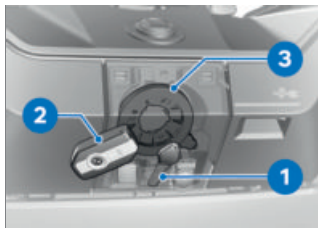

- If you lose your keys, refer to the notes regarding the electronic immobilizer (**EWS**).
- If you lose the radio-operated key while riding, you can start the vehicle by using the spare key.
- If the battery of the radio-operated key is dead, you can start the vehicle by touching the cover between the storage compartment flap and charging compartment flap with the radio-operated key.
- Hold the spare key **1** or the empty radio-operated key **2** against the cover between the storage compartment flap and charging compartment flap at the height of the antenna **3**.

58 OPERATION

ulations. Do not dispose of the battery in the household waste.

ATTENTION

Unsuitable or improperly inserted batteries

Component damage

- Use a battery compliant with the manufacturer's specifications.
 - When inserting the battery, make sure that the polarity is correct.
-
- Insert the new battery with the positive terminal facing up.



Battery type

For Keyless Ride radio-operated key

CR 2032

- Install battery cover **2**.
- » Red LED in instrument cluster blinks.
- » The radio-operated key is working again.

EMERGENCY-OFF SWITCH



- 1** Emergency-off switch
- The emergency-off switch **1** can be used to turn off the electric drive quickly.



- A** Electric drive turned off
- B** E-Scooter operational

REVERSING

Using reversing



WARNING

Reduced awareness of the E-Scooter in electric mode.

Accident hazard

- With driving in electric mode, pedestrians and others on the road may not be aware of the E-Scooter because of its lack of engine noise.
- Drive with particular care.

- Turn on ride readiness. (▮▮▮▮▶ 125)



- Press and hold button **1** during the entire reversing process.

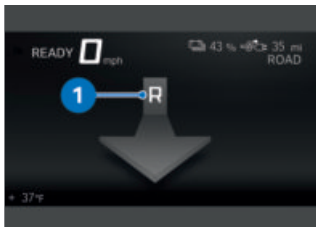

- The release is indicated in the display by a **R** with a down arrow icon **1**.
 - Carefully actuate the E-gas electronic throttle twistgrip and reverse.
- » The E-Scooter moves in reverse at a maximum of 2 mph (3 km/h).



- During reversing, the arrow icon **1** lights up.

60 OPERATION

LIGHTING

Low beams and parking lights

The parking lights are automatically turned on as soon as the E-Scooter is operational. The parking lights then continue to glow for a short time.

The low beams are automatically switched on as soon as the E-Scooter is ready to go.

High beams and headlight flasher

- Turn on standby mode. (▶▶▶ 54)



- Press switch **1** forward to turn on high beams.
- Pull switch **1** toward rear to actuate headlight flasher.

Headlight courtesy delay feature

- Turn off standby mode.



- Immediately after turning off standby mode, pull switch **1** back and hold it until the pathway lighting turns on.
 - » The vehicle lighting lights up for one minute and then turns off automatically.
 - This can be used, for example, to light the path to your front door after the vehicle is parked.

Roadside parking lights

- Turn off standby mode. (▶▶▶ 55)



- Immediately after turning off standby mode, push button **1**

to the left and hold it until the parking lights turn on.

- Switch standby mode on and then off again to switch off parking lights.

Operating the hazard warning system

- Turn on standby mode. (▶▶▶ 54)

 The hazard warning flashers place a strain on the battery. Do not use the hazard warning flashers for longer than absolutely necessary.

 If a turn indicator button is pressed when hazard warning lights are on, the turn indicator function replaces the hazard warning light function for the duration of turn indicator operation. Once the turn indicator button is no longer being pressed, the hazard warning light function will resume.



- Press button **1** to turn on the hazard warning system.

» Standby can be turned off.

- Turn on standby mode and press button **1** again to turn off the hazard warning system.

Operating turn signals

- Turn on standby mode. (▶▶▶ 54)
- Go to menu Settings, Vehicle settings, Lights.
- Turn Comfort turn indicator on or off.



- Press button **1** to the left to turn on the left-side turn signals.
- Press button **1** to the right to turn on the right-side turn signals.
- Press button **1** to turn off the turn signals.
- » If the comfort turn signal is turned on, the turn signals switch off automatically after the speed-dependent distance covered has been reached.

62 OPERATION

RIDING MODE

Use of the riding modes

BMW Motorrad has developed riding scenarios for your electric scooter from which you can select the one matching your situation:

- ECO: Range-optimized riding.
- RAIN: Riding on wet roads.
- ROAD: Riding on dry roads.

- with riding modes Pro^{OE}
- DYNAMIC: Brisk riding on dry roads.

The optimum interaction between engine characteristics, ASC/DTC control, and energy recovery stability control (RSC) is provided for each of these scenarios.

Setting riding mode

- Turn on standby mode.
( 54)



- Press button 1.

 You can find more detailed information regarding the selectable riding modes in the "Technology in detail" chapter.

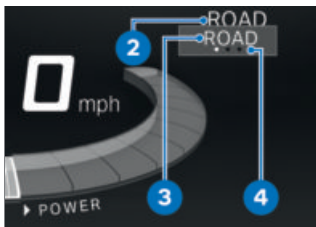

The active riding mode 2 fades into the background, and the first selectable riding mode 3 is displayed. The guide 4 shows how many riding modes are available.



- Press the button 1 repeatedly until the desired riding mode is shown next to the selection arrow.

- » The selected riding mode is activated after approx. 2 seconds.

ANTI-THEFT ALARM SYSTEM (DWA)

–with anti-theft alarm system (DWA)^{OE}

Activation

- Turn on standby mode. (▮▮▮▮▶ 54)
- Adjust the anti-theft alarm system. (▮▮▶ 65)



- Turn off standby mode.
- Press button **1** on the radio-operated key twice.
 - » Activation takes approximately 30 seconds to complete.
 - » Turn signals flash twice.
 - » Confirmation tone sounds twice (if programmed).
 - » Anti-theft alarm system is active.



- To deactivate the tilt sensor (for example, if you are about to transport the electric scooter on a train and the strong movement of the moving train could trip the alarm), press button **1** on the radio-operated key again during the activation phase.
 - » Turn signals flash three times.
 - » Confirmation tone sounds three times (if programmed).
 - » Tilt sensor is deactivated.

Alarm signal

The DWA alarm signal can be triggered by:

- Tilt sensor
- Switch-on attempt with an unauthorized ignition key.
- Disconnection of the DWA from the vehicle battery (DWA battery takes over the power supply – alarm tone only, turn signals do not flash)

64 OPERATION

 If the radio-operated key is within the reception area, any alarm signal triggered by the tilt alarm sensor is suppressed.

If the DWA battery is discharged, all functions remain operational; the only difference is that the alarm cannot be triggered if the system is disconnected from the vehicle battery.

The duration of the alarm signal is approx. 26 seconds. During the alarm signal, an alarm tone sounds and the turn signals blink. The type of alarm tone can be set by an authorized BMW Motorrad retailer.



You can cancel a triggered alarm signal at any time by pressing the button **1** of the radio-operated key without deactivating the DWA.

If an alarm signal has been triggered while the motorcycle was unattended, the rider is notified accordingly by an alarm tone sounding once when standby mode is turned on. Then the DWA LED indicates the reason for the alarm signal for one minute.

Light signals on indicator light:

- 1 blink: Tilt sensor 1
- 2 blinks: Tilt sensor 2
- 3 blinks: Standby mode is turned on using unauthorized ignition key.
- 4 blinks: Anti-theft alarm system disconnected from vehicle battery
- 5 blinks: Tilt sensor 3

Deactivation

Version 1:

- Emergency-off switch in operating position.
- Turn on standby mode.
( 54)
- » Turn signals flash once.
- » Confirmation tone sounds once (if programmed).
- » DWA is turned off.



Version 2:

- Press the button **1** on the radio-operated key once.

 If the alarm function is deactivated using the radio-operated key and standby is not then turned on, the alarm function will be reactivated automatically after approximately 30 seconds if *Arm automatically* is turned on.

- » Turn signals flash once.
- » Confirmation tone sounds once (if programmed).
- » DWA is turned off.

Adjusting the anti-theft alarm system

- Turn on standby mode. (▶▶▶ 54)
- Go to menu *Settings, Vehicle settings, Alarm system*.
- » The following settings are available:
 - Adapting Warning signal

- Turning Tilt sensor on and off
- Turning Arming tone on and off
- Turning Arm automatically on and off
- » Adjustment options (▶▶▶ 65)

Adjustment options

Warning signal: Set increasing and decreasing or intermittent alarm tone.

Tilt sensor: Activate the tilt sensor to monitor the inclination of the vehicle. The anti-theft alarm system responds, for example, in the event of attempted wheel theft or towing away.

 Deactivate the tilt sensor when transporting the vehicle to avoid triggering the DWA.

Arming tone: Confirmation alarm tone after activating/deactivating the DWA in addition to the turn signals lighting up.

Arm automatically: Automatic activation of the alarm function when standby mode is turned off.

66 OPERATION

TIRE PRESSURE MONITOR (TPM)

—with tire pressure monitor (TPM)^{OE}

Switching setpoint pressure warning on or off

- If the minimum tire pressure is reached, a target pressure warning can be displayed.
- Go to menu **Settings**, **Vehicle settings**, **RDC**.
- Turn **Target pressure warn. on or off**.

HEATING

Operating heated grips

—with heated grips^{OE}
—without seat heating^{OE}

 The heated grips are active only when standby is turned on.

- Turn on ride readiness. (▶▶▶ 125)





- Press the button **1** repeatedly until the desired heating

level **2** is shown in front of the heated grip icon **3**.

The handlebar grips can be heated at three different levels:

 Low heater output

 Medium heater output

 High heater output

» The high heating level is used for fast heat-up of the grips; then the switch should be switched back to the 1st level.

» If no further changes are made, the selected heating level is set.

- To turn off the heated grips, press the button **1** repeatedly until the heated grip icon **3** disappears.

Operating the heating

—with heated grips^{OE}
—with seat heating^{OE}

 The heated grips and the seat heating are active only when standby is turned on.

- Turn on ride readiness. (▶▶▶ 125)



- Press button **1**.
 - » The HEATING menu opens.
- Select Heated handlebar grips or Seat heating.
- Select the desired heating level and confirm.
 - » The selected heating level is shown in the display to the left of the heating symbols **2**.
- Press the **1** button to close the HEATING menu.
- To switch the heater off or on again using the previously selected heating levels, press and hold the **1** button.

 The heating level settings are retained even after standby is turned off.

STORAGE COMPARTMENT

Using the storage compartment Requirement

Standby mode is turned on.



ATTENTION

High temperatures in the storage compartments, especially in summer

Damage to objects housed here, particularly electronic devices such as mobile phones

- Do not place objects that are sensitive to heat in the storage compartment during the summer.
- Ask the manufacturer about possible limits of use and observe them.



ATTENTION

Vibrations during riding

Damage to stored mobile phones

- Make sure that the stored mobile phone is suitable for use on the motorcycle. To do so, ask the manufacturer about limits of use and observe them.

68 OPERATION



- Open the storage compartment flap **1** by pressing the button **2**.

» The open storage compartment flap is not suitable for storage of objects.

- To close, press the storage compartment flap **1** into the locking mechanism with firm pressure.

Ventilation

Starting from a temperature of 95 °F (35 °C), a fan is turned on in the storage compartment to ensure sufficient air circulation. The fan switches off again as soon as the temperature in the storage compartment is below 86 °F (30 °C).

Charging a smartphone Requirement

Standby mode is turned on.

- Open storage compartment.



- Insert the smartphone **2** into the cradle **1** with the display facing up.

» The smartphone is fastened in place.



- Connect the charging cable with the smartphone **2** and USB-C connection **3**.

 BMW Motorrad recommends the use of the BMW Motorrad USB cable for charging smartphones in the storage compartment. The space in the storage compartment may be insufficient for commercially available charg-

ing cables, which may be damaged.



- Close the storage compartment flap **4**.

Notes about use

The storage compartment is suitable for smartphones with dimensions up to a maximum of 6.2 in (158 mm) x 3.1 in (78 mm) x 0.39 in (10 mm). For small mobile phones that might not be held securely by the holder, BMW Motorrad recommends the use of a BMW Motorrad smartphone case.

Charge current

This is a 5 V USB-C charging socket providing a maximum charge current of 1.5 A (maximum charge power of 7.5 W).

HELMET COMPARTMENT

Using the helmet compartment

- Turn on standby mode.

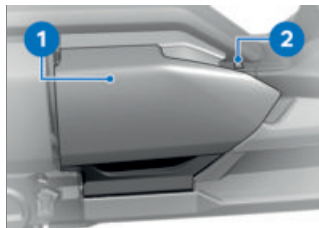

- Open helmet compartment flap **1** with button **2**.



The lighting of the storage compartment is turned on when standby is turned on. After standby is turned off, the storage compartment lighting remains on for a brief period.



Payload of the helmet compartment

max 18 lbs (max 8 kg)

- » The open helmet compartment flap is not suitable for storage of objects.
- To close it, press the center of the helmet compartment flap **1** into the locks with firm pressure.
- » The helmet compartment flap will audibly engage with both lock hooks.

70 OPERATION

Perform emergency release of helmet compartment

- Remove side panel. (▶▶▶ 157)

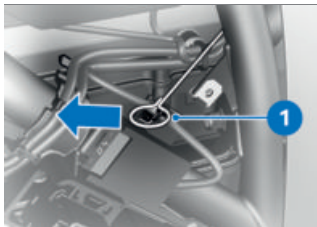

- Pull tab **1** in arrow direction, if necessary, using the on-board vehicle tool kit.
 - » Helmet compartment unlocked.
- Install side panel. (▶▶▶ 157)

TFT DISPLAY

05

GENERAL NOTES	74
PRINCIPLE	75
PURE RIDE VIEW	81
PURE VIEW	82
SPLIT SCREEN	82
GENERAL SETTINGS	83
BLUETOOTH®	85
WI-FI	87
MY VEHICLE	88
TRIP COMPUTER	91
NAVIGATION	92
MEDIA	94
TELEPHONE	95
DISPLAYING SOFTWARE VERSION	96
DISPLAYING LICENSE INFORMATION	96

Currentness of this manual

After the editorial deadline, there may be updates to the TFT display. For this reason, some aspects of your vehicle may vary from the descriptions in this rider's manual. Updated information is available at bmw-motorrad.com/service.

PRINCIPLE

Operating elements

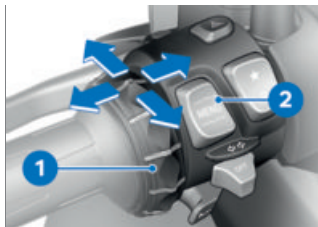

All content on the display is controlled by the Multi-Controller **1** and the rocker button **MENU 2**.

The following functions are possible depending on the context.

Functions of the Multi-Controller

Turn the Multi-Controller up:

- Move the cursor up in lists.
- Make settings.
- Increase volume.

Turn the Multi-Controller down:

- Move the cursor down in lists.
- Make settings.
- Reduce volume.

Tilt Multi-Controller to the left:

- Activate the function according to the operating feedback.
- Activate function to the left or back.
- After settings, return to menu view.
- In Menu view: Change a hierarchy level up.
- In the *My vehicle* menu: Browse to the next menu screen.
- In Pure Ride view: Browse to the previous split screen display.

Tilt Multi-Controller to the right:

- Activate the function according to the operating feedback.
- Confirm selection.
- Confirm settings.
- Browse to the next menu step.
- Scroll to right in lists.
- In the *My vehicle* menu: Browse to the next menu screen.

76 TFT DISPLAY

-In Pure Ride view: Browse to the next split screen display.

Rocker button MENU functions

 Navigation instructions are displayed as a dialog if the Navigation menu has not been called up. Operation of the MENU rocker button is temporarily restricted.

Briefly press the MENU up:

- In Menu view: Change a hierarchy level up.
- In Pure (Ride) view: Change the status line display.

MENU long press up:

- In Menu view: Open Pure Ride view.

MENU short press down:

- Change a hierarchy level down.
- No function when lowest hierarchy level is reached.

MENU long press down:

- Return to the last menu, after a menu change has been previously carried out by long press of the rocker button MENU at the top.

Operating instructions in the main menu

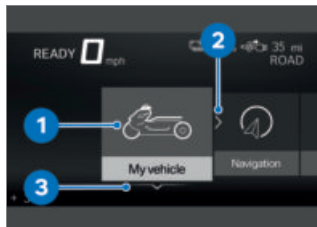

The operating instructions indicate whether and which interactions are possible.

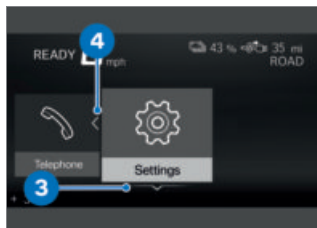

Meaning of the operating instructions:

- Operating instructions 1: The left end has been reached.
- Operating instructions 2: You can browse to the right.
- Operating instructions 3: You can browse down.
- Operating instructions 4: You can browse to the left.

Operating instructions in submenus

In addition to the operating instructions in the main menu, there are additional operating instructions in submenus.

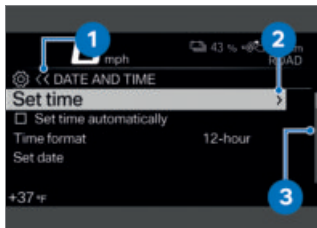

Meaning of the operating instructions:

- Operating instructions **1**: The current display is in a hierarchical menu. One icon indicates one submenu level. Two icons indicate two or more submenu levels. The color of the icon changes depending on whether there is an option to return to the top.
- Operating instructions **2**: You can go to another submenu level.
- Operating instructions **3**: There are more entries than can be displayed.

Turning functions on and off

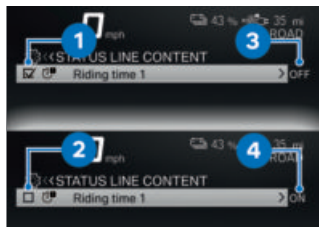

Some menu items are preceded by a box. The box indicates whether the function is turned on or off. Action icons after the menu items illustrate what is switched by briefly tilting the Multi-Controller to the right.

Examples for turning on and off:

- Icon **1** indicates that the function is turned on.
- Icon **2** indicates that the function is turned off.
- Icon **3** indicates that the function can be turned off.
- Icon **4** indicates that the function can be turned on.

Show Pure (Ride) view

- Press and hold the top of the rocker button MENU.

78 TFT DISPLAY

Go to the menu

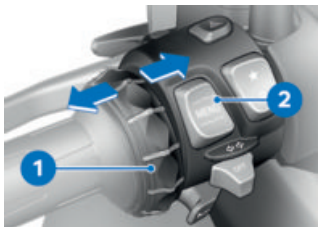

- Show Pure (Ride) view. (▣▣▣ 77)
- Briefly press button **2** downward.

You can go to the following menus:

- My vehicle
- Navigation
- Media
- Telephone
- Settings

- Press Multi-Controller **1** repeatedly briefly to the right until the desired menu item is marked.
- Briefly press button **2** downward.

 The Settings menu can only be called up when stationary.

Moving the cursor in lists

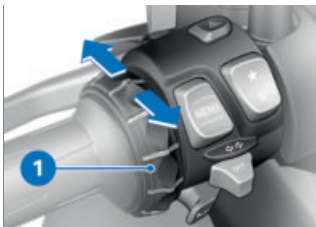

- Go to the menu. (▣▣▣ 78)
- To move the cursor down in lists, turn the Multi-Controller **1** down until the desired entry is selected.
- To move the cursor up in lists, turn the Multi-Controller **1** up until the desired entry is selected.

Confirming the selection

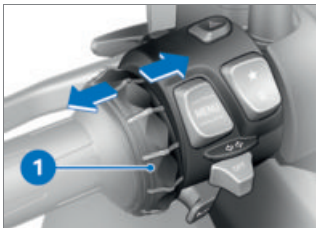

- Select desired entry.
- Multi-Controller **1** short press to right.

Go to the last menu used

- In Pure Ride view: Press and hold the bottom of the MENU rocker button.
- » The last used menu is called up. The last marked entry is selected.

Changing the status line display

Requirement









The vehicle is stationary. The Pure (Ride) view is displayed.

- Turn on standby mode. (▮▮▮▮▶ 54)
- » All of the information necessary for operating the vehicle on public roads is made available from the on-board computer (e.g. TRIP 1) and travel on-board computer (e.g. TRIP 2) in the TFT display. The information can be displayed in the upper status line.
- with tire pressure monitor (TPM)^{OE}
- » In addition, information from the Tire Pressure Monitor can be displayed.◀
- Select content of upper status line. (▮▮▮▮▶ 80)



- Press and hold button 1 to display the Pure Ride view.
- Press button 1 briefly to select the value in the upper status line 2.

The following values can be displayed:

-  Total distance
-  Current distance 1
-  Current distance 2
-  Consumption 1 (average)
-  Consumption 2 (average)
-  Recuper. 1
-  Recuper. 2
-  Riding time 1

80 TFT DISPLAY

 Riding time 2

 Break 1

 Break 2

 Speed 1 (average)

 Speed 2 (average)

—with tire pressure monitor (TPM)^{OE}

 Tire pressure<

Selecting content of upper status line

- Go to menu Settings, Display, Status line content.
- Turn on desired displays.
- » It is possible to change between the selected displays in the upper status line. If no displays are selected, the state of charge and the range are displayed:

 Battery state of charge

 Range

Making settings

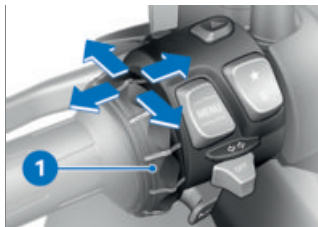

- Select desired settings menu and confirm.
- Turn Multi-Controller **1** down until the desired setting is marked.
- If operating instructions are present, tilt the Multi-Controller **1** to the right.
- If no operating instructions are present, tilt the Multi-Controller **1** to the left.
- » The setting is saved.

Turning Speed Limit Info on or off

Requirement

The vehicle is connected to a compatible mobile end device. The BMW Motorrad Connected app is installed on the mobile end device.

- Speed Limit Info displays the currently permitted maximum speed insofar as this information is provided by the

editor of the maps in the navigation system.

- Call up menu **Settings**, **Display**.
- Turn **Speed Limit Info** on or off.

Programmable memory buttons



- In the menu **Settings**, **System settings**, **Favourite button**, select **Star**.
 - Select the desired function or **Not assigned**.
- » Each time you press the button **1**, it calls up the selected function.

PURE RIDE VIEW

Drive display



- 1 Range of energy recovery torque
- 2 Current energy recovery or drive torque
- 3 Range of drive torque

Limitations



Mark **1** indicates that the energy recovery is limited.

Mark **4** indicates that the power is limited.

In connection with limitations, the following icons can appear in the top right of the display:

Icon **2**: Energy recovery is severely limited

82 TFT DISPLAY

Icon **3**: Power is severely limited

Limitations can have various causes. The cause of the limitation is indicated by the color of the mark **1** or **4**:

- Gray: limitation is the result of the riding mode
- Yellow: System limitations, e.g. due to temperature, state of charge, continuous load or system fault.

 Temporary limitation of available power under excessive continuous load prevents the battery from aging prematurely.

Range and state of charge



The range **2** indicates the distance you can cover with the remaining state of charge **1**.

PURE VIEW

Display

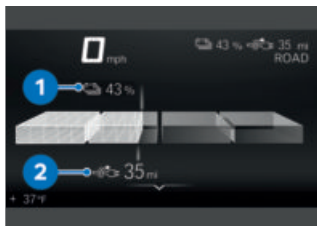



If the vehicle is not ready to ride, the Pure view appears in the display instead of the Pure Ride view.

The state of charge **1** and range **2** are displayed.

SPLIT SCREEN

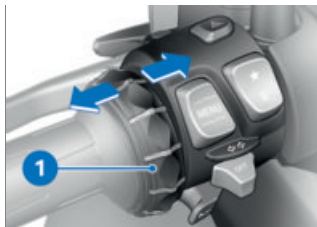
Turning on the split screen and selecting a display



- Show Pure (Ride) view. ( 77)
- Briefly press the Multi-Controller **1** to the left or right repeatedly until the desired display appears.

- Alternative: Press the Multi-Controller **1** to the right and hold it to return to the last selected display in the split screen.

The following displays can be selected:

- ONBOARD COMPUTER
- TRIP COMPUTER
- Navigation
- MEDIA

» The selected display remains even after standby mode is turned off.

Turning off split screen

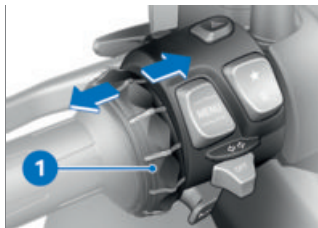

- Show Pure (Ride) view. (▮▮▮▮ 77)
- Briefly press the Multi-Controller **1** to the left repeatedly until the split screen disappears.
- Alternative: Press the Multi-Controller **1** to the left and hold it.

GENERAL SETTINGS

Adjusting the volume

- Connect the rider's helmet and the passenger helmet. (▮▮▮▮ 86)
- Increase volume: Turn the Multi-Controller up.
- Decrease volume: Turn the Multi-Controller down.
- Mute: Turn the Multi-Controller all the way down.
- » When set to Mute, media playback is paused.

Setting the date

- Turn on standby mode. (▮▮▮▮ 54)
- Go to menu Settings, System settings, Date and time, Set date.
- Set Day, Month, and Year.
- Confirm setting.

Adjusting the date format

- Go to menu Settings, System settings, Date and time, Date format.
- Select desired setting.
- Confirm setting.

Setting the clock

- Turn on standby mode. (▮▮▮▮ 54)
- Go to menu Settings, System settings, Date and time, Set time.

84 TFT DISPLAY

- Set Hour and Minute.

Setting the time format

- Go to menu Settings, System settings, Date and time, Time format.
- Select desired setting.
- Confirm setting.

Setting the units of measurement

- Go to menu Settings, System settings, Units.

The following units of measurement can be set:

- with tire pressure monitor (TPM)^{OE}
- Pressure◀
- Temperature
- Consumption

Setting the language

- Go to menu Settings, System settings, Language.

The following languages can be set:

- German
- English (UK)
- English (US)
- Spanish
- French
- Italian
- Dutch
- Polish
- Portuguese (Brazil)
- Portuguese (Portugal)
- Turkish

- Russian
- Ukrainian
- Chinese
- Japanese
- Korean
- Thai
- Romanian

Adjusting brightness

- Go to menu Settings, Display, Brightness.
 - Adjust brightness.
- » The brightness of the display is dimmed to the set value if ambient brightness falls below a defined value.

Resetting all settings

- All settings in the Settings menu can be reset to the factory settings.
- Go to the Settings menu.
- Select Reset all and confirm.

The settings of the following menus are reset:

- Vehicle settings
- System settings
- Connections
- Display
- Information

- » Existing Bluetooth connections are not deleted.

BLUETOOTH®

Short-range radio technology

Bluetooth is a close-range wireless technology. Bluetooth devices are short-range devices (transmitting with a limited range) on the license-free ISM band (Industrial, Scientific, Medical) between 2.402...2.480 GHz. They can be operated anywhere in the world without a license being required.

Although Bluetooth is designed for establishing robust connections over short distances, faults are possible as with any other wireless technology. Connections can be subject to interference, can be briefly interrupted or lost entirely. Especially when several devices are operated in one Bluetooth network, there is no guarantee for smooth operation in every situation.

Possible sources of interference:

- Interference fields due to transmission towers and similar.
- Devices with incorrectly implemented Bluetooth radio standard.

- By nearby Bluetooth-capable devices.
- Shielding by metals or bodies.

Pairing

Two Bluetooth devices have to recognize each other before they can communicate. This process of mutual recognition is known as pairing. When two devices have paired they remember each other, so the pairing process is conducted only once, on initial contact.

 On some mobile devices, e.g. with operating system iOS, the BMW Motorrad Connected App must be called up before using.

During the pairing process, the TFT display searches for other Bluetooth-compatible devices within its reception range. The conditions that have to be satisfied before a device can be detected are as follows:

- The Bluetooth® function of the device must be activated
- The device must be "visible" to others
- Other Bluetooth-capable devices must be OFF (e.g. mobile phones and navigation systems).

86 TFT DISPLAY

Please consult the operating instructions for your communication system.

Carrying out pairing

- Call up menu `Settings, Connections`.
- » Bluetooth connections can be established, managed, and deleted in the `CONNECTIONS` menu. The following Bluetooth connections are displayed:

- Mobile device
- Rider's helmet
- Passenger helm.

The connection status for mobile end devices is displayed.

Connecting a mobile end device

- Carry out pairing. (▶▶▶ 86)
- Activate the Bluetooth function of the mobile end device (see operating instructions for the mobile end device).
- Select `Mobile device` and confirm.
- Select `Pair new mobile device` and confirm.

Mobile end devices are searched for.



blinks in the lower status line during pairing.

Visible mobile end devices are displayed.

- Select the mobile end device and confirm.
- Observe the instructions for the mobile end device.
- Confirm that the codes match.
- » The connection is established and the connection status is updated.
- » If the connection is not established, the troubleshooting chart may provide assistance. (▶▶▶ 184)
- » Depending on the mobile end device, telephone data is transferred to the vehicle automatically.
- » Telephone data (▶▶▶ 96)
- » If the phone book is not displayed, the troubleshooting chart may provide assistance. (▶▶▶ 185)
- » If the Bluetooth connection does not work as expected, the troubleshooting chart may provide assistance. (▶▶▶ 185)

Connect the rider's helmet and the passenger helmet

- Carry out pairing. (▶▶▶ 86)
- Select `Rider's helmet` or `Passenger helm.` and confirm.
- Show the communication system of the helmet.

- Select **Pair new rider's helmet** or **Pair new passenger helmet** and confirm. Helmets are searched for.



blinks in the lower status line during pairing.

Visible helmets are displayed.

- Select helmet and confirm.
 - » The connection is established and the connection status is updated.
 - » If the connection is not established, the troubleshooting chart may provide assistance. (▶▶▶▶▶ 184)
 - » If the Bluetooth connection does not work as expected, the troubleshooting chart may provide assistance. (▶▶▶▶▶ 185)

Deleting connections

- Call up menu **Settings, Connections**.
- Select **Delete connections**.
- To delete an individual connection, select the connection and confirm.
- To delete all connections, select **Delete all connections** and confirm.

WI-FI

WiFi connection

A WiFi connection is used to transmit the map view from a mobile phone to the TFT display. To enable the full scope of function, WiFi must be enabled on the mobile phone. More information on activating WiFi can be found in the operating instructions of the mobile phone.

Depending on local conditions, such as a high number of WiFi networks, temporary limitations and connection dropouts can occur.

88 TFT DISPLAY

MY VEHICLE START SCREEN



- 1 Check Control display Layout (➡ 26)
- 2 Status of coolant temperature (➡ 40)
- 3 Range (➡ 82)
- 4 Odometer
- 5 Service display (➡ 50)
- 6 Rear tire pressure (➡ 45)
- 7 Status of high-voltage energy storage system temperature
- 8 Front tire pressure (➡ 45)

Operating instructions



- Operating instructions **1**: Tabs that show how far to the left or right you can browse.
- Operating instructions **2**: Tab that shows the position of the current menu screen.

Browsing through menu screens

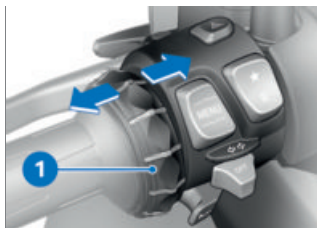

- Go to the **My vehicle** menu.
- To browse to the right, briefly press the Multi-Controller **1** to the right.
- To browse to the left, briefly press the Multi-Controller **1** to the left.

The following screens are included in the **My vehicle** menu:

- MY VEHICLE
- ONBOARD COMPUTER
- TRIP COMPUTER
- with tire pressure monitor (TPM)^{OE}
- TIRE PRESSURE<
- SERVICE REQUIREMENTS
- CHECK CONTROL MESSAGE (if present)
- More information about tire pressure and Check Control messages can be found in the "Displays" chapter.



Check-Control messages are dynamically added to the menu screens in the **My vehicle** menu as additional tabs.

On-board computer and travel on-board computer

The ONBOARD COMPUTER and TRIP COMPUTER menu windows show the vehicle and journey data, e.g. average values.

90 TFT DISPLAY

Service requirement

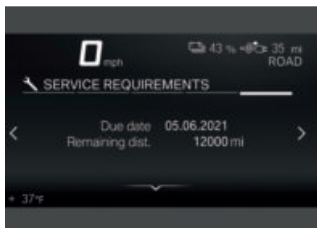

If the time remaining until the next service is less than a month, or if the next service is due within 700 mi (1000 km), a white Check Control message is displayed.

TRIP COMPUTER

Calling up the on-board computer

- Go to the `My vehicle` menu.
- Scroll to the right until the `ONBOARD COMPUTER` menu screen is displayed.
 - » As an alternative, the on-board computer can also be displayed on the split screen.
- Turn on the split screen and select a display. (▣▣▣▣ 82)

Resetting the on-board computer

- Go to the on-board computer. (▣▣▣▣ 91)
- Press `MENU` rocker button down.
- Select `Reset all values` or `Reset individual values` and confirm.

The following values can be reset individually:



Journey



Current



Speed



Consump.



Recuper. 1

Calling up the travel on-board computer

- Go to the on-board computer. (▣▣▣▣ 91)
- Scroll to the right until the `TRIP COMPUTER` menu screen is displayed.
 - » As an alternative, the travel on-board computer can also be displayed on the split screen.
- Turn on the split screen and select a display. (▣▣▣▣ 82)

Resetting the travel on-board computer

- Go to the travel on-board computer. (▣▣▣▣ 91)
- Press `MENU` rocker button down.
- Select `Automatic reset` or `Reset all values` and confirm.
 - » If `Automatic reset` is selected, the travel on-board computer is automatically reset if at least 6 hours have passed since standby mode was turned off and the date has changed.

Entering destination address

- Connect mobile terminal.
(▶▶▶▶ 86)
- Go to the BMW Motorrad Connected app and start the guidance.
- Go to menu *Navigation* in the TFT display.
 - » Active destination guidance is displayed.
 - If WiFi is not activated on the mobile end device, route guidance is displayed as an arrow view.
 - » If the active route guidance is not displayed, the troubleshooting chart may provide assistance. (▶▶▶▶ 185)

Select destination from most recent destinations

- Call up menu *Navigation*, *Recent destinations*.
- Select destination and confirm.
- Select *Start route guidance*.

Select destination from favorites

- The *FAVORITES* menu shows all destinations that have been saved as a favorite in the BMW Motorrad Connected app. It is not possible to create new favorites on the TFT display.

- Call up menu *Navigation*, *Favorites*.
- Select destination and confirm.
- Select *Start guidance*.

Entering special destinations

- Special destinations, e.g. landmarks, can be displayed on the map.
- Call up menu *Navigation*, *POIs*.

The following locations can be selected:

- At current location
- At destination
- Along the route
- Select in which location you want to search for special destinations.

The following point of interest can be selected:

- Filling station
- Select special destination and confirm.
- Select *Start route guidance* and confirm.

Specifying route criteria

- Call up menu *Navigation*, *Route criteria*.

The following criteria can be selected:

- *Route type*
- *Avoid*
- Select desired *Route type*.

94 TFT DISPLAY

- Turn desired *Avoid* on or off. The number of enabled avoidances is displayed in brackets.

Display route info

- Go to the *Navigation, Settings* menu, then select the *Route info* menu item. You can select between the following options:
 - *Destination*
 - *Waypoint*
- Select desired option.
 - » The remaining distance and time are displayed.

Editing guidance

- Call up menu *Navigation, New destination*. You can select between the following destinations:
 - *Recent destinations*
 - *Favorites*
 - *POIs*
- Select destination from one of the three destination categories.
- Select *Edit route guidance* in the destination entry.
- Select *Add stop* to add the selected destination as a waypoint.
- Select *Start guidance* to overwrite the current destination.

Ending route guidance

- Call up menu *Navigation, Active route guidance*.
- Select and confirm *End route guidance* or tilt the *Multi-Controller* to the left.

Switching spoken instructions on or off

- Connect the rider's helmet and the passenger helmet. (🔊▶ 86)
- The navigation can be read out by a computer voice. To do this, the *Spoken instructions* must be turned on.
- Call up menu *Navigation, Active route guidance*.
- Turn *Spoken instructions* on or off.

Repeating the last spoken instruction

- Call up menu *Navigation, Active route guidance*.
- Select *Current instruction* and confirm.

MEDIA

Prerequisite

The vehicle is connected to a compatible mobile end device and a compatible helmet.

Controlling audio playback

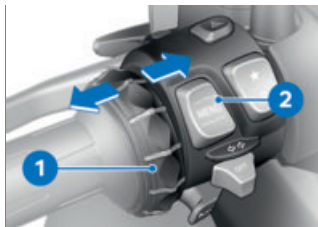

- Go to the **Media** menu.

 BMW Motorrad recommends setting the volume for media and conversations via mobile end devices to the maximum before starting a journey.

- Adjust the volume. (▶▶▶ 83)
- Next title: Briefly tilt Multi-Controller **1** to the right.
- Last title or beginning of the current title: Briefly tilt Multi-Controller **1** to the left.
- Go to context menu: Press button **2** downward.

 Depending on the mobile end device, the scope of the Connectivity functions may be limited.

- » The following functions can be used in the context menu:
 - Playback or Pause.
 - For search and playback, select the category *Now playing*, *All artists*, *All albums*, or *All tracks*.

- Select Playlists.

In the **Audio** settings sub-menu you can adjust the following settings:

- Turn **Shuffle** on or off.
- Repeat: Select **Off**, **One** (current track), or **All**.

» If the playlist is not displayed on the TFT display, the troubleshooting chart may provide assistance. (▶▶▶ 186)

TELEPHONE

Prerequisite

The vehicle is connected to a compatible mobile end device and a compatible helmet.

Making a phone call

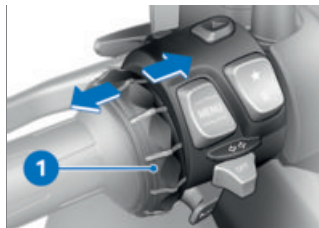

- Go to the **Telephone** menu.

 When a call comes in, a pop-up opens.

- Accepting a call: Tilt Multi-Controller **1** to the right.
- Rejecting a call: Tilt Multi-Controller **1** to the left.

96 TFT DISPLAY

- Ending a call: Tilt Multi-Controller **1** to the left.

Mute

The microphone in the helmet can be muted during active conversations.

Conversations with multiple users

A second telephone call can be accepted during a conversation. The first conversation will be put on hold. The number of active telephone calls is displayed in the Telephone menu. It is possible to switch between two conversations.

Telephone data

Depending on the mobile end device, telephone data is transferred to the vehicle automatically after pairing (►► 85).

Phone book: List of contacts saved in the mobile end device

Call list: List of telephone calls with the mobile end device

Favorites: List of favorites saved in the mobile end device

DISPLAYING LICENSE INFORMATION

- Go to menu Settings, Information, Licenses.

DISPLAYING SOFTWARE VERSION

- Go to menu Settings, Information, Software version.

SETTING

06

MIRRORS	100
HEADLIGHTS	100
SPRING PRELOAD	101

100 SETTING

MIRRORS

Adjusting the mirrors



- Move mirror into desired position by pressing it lightly.

 If the adjustment range of the mirror is insufficient for correct alignment, the position of the mirror arm must be adapted.

Adjusting the mirror arm



- Slide the protective cap **1** upwards over the threaded connection on the mirror arm.
- Unscrew nut **2** with suitable tool.
- Turn the mirror arm into the desired position.

- Tighten the nut **2** to the specified torque while holding the mirror arm in place.

 Left mirror (lock nut) to adapter

M10

16 lb/ft (22 Nm) (Left-hand thread)

- Slide protective cap **1** over threaded connection.

HEADLIGHTS

Headlight range and spring preload

The headlight range generally remains constant due to the adjustment of the spring preload to the load status.

If you are not sure about the correct headlight range setting, contact a BMW Motorrad partner.

Adjusting the headlight range

- Remove the front-fairing panel. (→ 156)

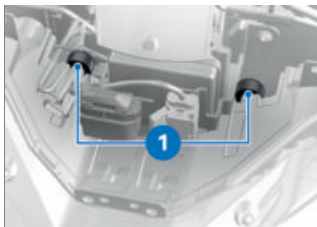

In case of a high payload, you have to adjust the spring preload to maintain the correct beam height and avoid dazzling oncoming traffic. If the spring preload adjustment is insufficient, then the headlight range must also be corrected at the headlight.

- Adjust the headlight range using the adjustment screws **1**.
- Install the front-fairing panel. (▮▮▮▮ 156)

If the electric scooter is again ridden with a lower payload:

- Have the headlight base setting restored by a repair shop, preferably an authorized BMW Motorrad retailer.

SPRING PRELOAD

Setting

It is essential to set the spring preload at the rear wheel to suit the load carried by the E-Scooter. Increase spring preload if the payload increases and reduce spring preload accordingly if the payload decreases.

Adjust spring preload on the suspension strut

- Park the E-Scooter, making sure it is on level and firm ground.

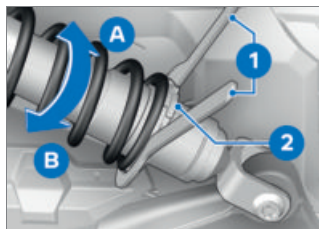

- Loosen lock nut **2**.
- To increase the spring preload, turn the adjusting ring in the arrow direction **A** using the onboard toolkit **1**.
- To decrease the spring preload, turn the adjusting ring in the arrow direction **B** using the onboard toolkit **1**.

102 SETTING

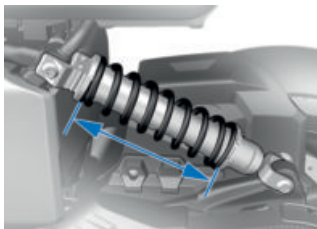

Basic setting of spring
preload, rear

Spring length in base setting
257.5 mm (with an 85 kg
rider)

Spring length in base setting
257.5 mm (One-up without
load)

Spring length in base set-
ting 247.5 mm (One-up with
load)

Spring length in base setting
227.5 mm (Two-up mode
with load)

- Tighten lock nut **2**.

BMW EPOWER

07

PRINCIPLE	106
GENERAL NOTES	106
CHARGING CABLE	108
CHARGING PROCEDURE	110

PRINCIPLE

The vehicle can be operated completely emission-free thanks to its electrical drive system.

The special high-voltage energy storage system supplies the electrical machine with power. The high-torque electrical machine ensures dynamic handling characteristics in all driving situations, such as, starting, accelerating and driving at high speeds.

The high-voltage energy storage system is charged via a charging cable, when parked, for example, or through energy recovery while riding.

Special power supplies allow for especially fast charging. But it is also possible to charge the vehicle using a common household power outlet, such as those found in residential buildings.

Energy recovery

The high-voltage energy storage system is charged during the journey through energy recovery. Energy recovery ensures that very little energy is lost during deceleration. When the vehicle slows down the electrical machine becomes

a generator and converts into electricity some or all of the energy of motion released. This partly recharges the high-voltage energy storage system, enabling the maximum possible range. This charging can occur while the vehicle is in motion with the throttle position closed or in energy recovery operation.

For detailed information on energy recovery by braking, see the "Riding" chapter (125). The indicator in the instrument cluster is in the CHARGE field. Anticipatory driving and timely reduction of speed are important for utilizing the vehicle's energy recovery optimally.

GENERAL NOTES



DANGER

Improper handling of electrical power.

Injury or material damage, e.g. due to electric shock or fire.

- Observe the safety regulations.

**ATTENTION****Failure to check the charging equipment before operating the vehicle**

Damage and excessive strain on the power supply

- Before the first charging procedure have your charging equipment checked by an electrical technician at the charging station.

**CAUTION****Failure to adhere to the information at the charging station**

Injury or damage as a result, for example, of electric shock or fire

- Adhere to the information at the charging station.

**ATTENTION****Defective charging equipment**

Risk of fire as a result, for example, of worn contacts or damage

- Only use charging equipment if there is no damage to it.

**DANGER****Improper cleaning of charging connection.**

Injury or damage as a result, for example, of electric shock or fire.

- Have the charging connection cleaned by appropriately trained staff only.



Do not let the E-Scooter sit with a low state of charge for an extended period of time.

Before extended parking periods, check the charge state indicator to ensure that the high-voltage energy storage system is fully charged. The high-voltage energy storage system will be damaged if it is discharged too much.



If the range is below 19 miles (30 km), charge the high-voltage energy storage system. Otherwise the power of the electric drive could decline significantly.

108 BMW EPOWER

What to do in the event of an accident

DANGER

Touching high-voltage lines after an accident.

Risk of death from electric shock.

- After an accident, do not touch high-voltage lines, such as the orange lines, or components that come into contact with exposed high-voltage lines.

CAUTION

Fluid escaping from the high-voltage energy storage system

Risk of chemical burn

- Do not touch fluids escaping from the high-voltage energy storage system.

If you are in an accident with your vehicle, the following safety precautions should be noted with respect to the high-voltage system:

- Secure the accident scene.
- Immediately inform emergency services personnel, police officers or fire fighters

that the vehicle has a high-voltage system.

- Turn off standby mode.
- Do not inhale gases escaping from the high-voltage energy storage system. Maintain a distance to the vehicle if necessary.

CHARGING CABLE

DANGER

Use of charging cables that are not approved.

Injury or property damage, e.g. from fire in the electrical system.

- For charging, use only approved charging cables and charging stations.
- Ask your service center for information on approved cables.

ATTENTION

Improper use of the charging cable

Damage as a result, for example, of a cable fire

- Only use the charging cable to charge the E-Scooter.
- Do not extend the charging cable with other cables or adapters.

**DANGER****Use of damaged charging cable.**

Injury or damage as a result, for example, of electric shock or fire.

- Do not use damaged charging cables.
- Immediately discontinue use of damaged charging cables (e.g., if there is damage to the casing or cable).



Opening the charging cable components will lead to damage and loss of the warranty. Only the manufacturer can repair the charging cable or replace the components (connector, coupling or In-cable Modul).



The high-voltage charging socket must be protected from moisture and dirt using the protective cap.

Depending on the national-market version, different charging cables are required and included in the scope of delivery.

The charging cable can be stored away in the helmet compartment.

As an alternative, use a permanently installed cable of a charging station.

Standard charging cable

The standard charging cable can be used to charge the vehicle at domestic socket outlets with a protective conductor. The electrical connection of a domestic socket outlet uses alternating current to charge the vehicle.

Take note of the detailed operating instructions of the standard charging cable:

www.apativ.com/online-manual

Readings of the standard charging cable

The standard charging cable indicates its status using four LEDs.

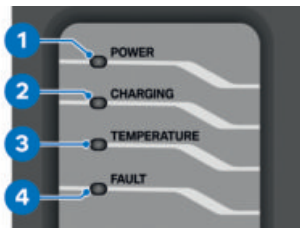

- 1: Power supply from the domestic socket outlet or the charging station
- 2: Charge indicator
- 3: Temperature monitoring
- 4: Fault from the domestic socket outlet or the charging station or the charging unit

CHARGING PROCEDURE

Before charging



DANGER

Failure to adhere to the power supply connection safety information.

Injury or damage as a result, for example, of electric shock or fire.

- See the safety information for the respective power supply connection.



ATTENTION

No adaptation of the charge current to the electrical grid

Risk of fire e.g. from overheating the domestic socket outlet or excessive load on the electrical grid

- Before charging at domestic socket outlets, check their maximum power rating and adapt the charge current limit to the electrical grid.



The charging procedure can be stopped at any time and continued at a later point so other consumers can use the power supply or to avoid high power consumption as a result of simultaneous use by multiple consumers.



If the charging process is interrupted, e.g. by a temporary power failure, the charging process continues automatically after the interruption. If the interruption lasts more than 2 minutes, the charging process does not continue automatically.



If the outside temperatures are extreme, the charging process slows down

to protect the high-voltage energy storage system.

 The standard charging cable is not functional at temperatures below -26°F (-32°C). Store the charging cable in a location with an ambient temperature between -26°F (-32°C) and 104°F (40°C) before the charging process.

Using the charging compartment



- Open charging compartment flap **1** with handle **2**.
- » The open charging compartment flap is not suitable for storage of objects.
- To close, press the charging compartment flap **1** into the lock with firm pressure.

Setting the charge current

- Turn on standby mode.
( 54)
- Set the charge current in the menu *Settings, Vehicle*

settings, Charging settings, Charging curr. limit.

 If the domestic socket outlet or the charging station supplies a deviating charge current, the respective lower charge current is used for charging.

Start charging procedure

- Turn off standby mode.
( 55)
- » The charging procedure will not start until standby mode has been turned off. If standby mode is turned back on during the charging procedure, the charging procedure will be interrupted.
- Open the charging compartment.

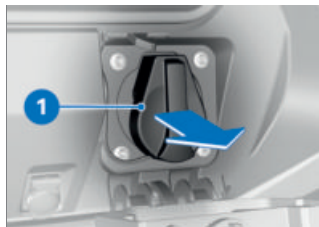

- Remove the charging connection cover **1**.
- Remove the protective cap from the charging plug.

ATTENTION

No adaptation of the charge current to the electrical grid

Risk of fire e.g. from overheating the domestic socket outlet or excessive load on the electrical grid

- Before charging at domestic socket outlets, check their maximum power rating and adapt the charge current limit to the electrical grid.
- Before charging at your own domestic socket outlet for the first time and when charging at someone else's domestic socket outlet, find out the permitted charge current level, e.g. from a qualified electrician. If the permitted charge current level is unknown, set the charging current limit to the lowest level.
- » The factory setting for the charging current limit is set to a charge current of 6 A.
- Where appropriate, set the charging current limit in the menu `Settings, Vehicle settings, Charging settings, Charging curr. limit`.

 If the domestic socket outlet or the charging station supplies a deviating charge current, the respective lower charge current is used for charging.

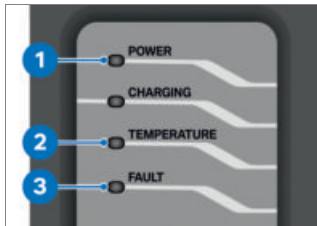

- Connect the standard charging cable at the domestic socket outlet or the Mode3 charging cable at the charging station, as applicable. If charging at a charging station, follow the instructions at the charging station.
- » The standard charging cable automatically carries out all necessary test steps. If LED **1** is lit during this, the test was successful. If LED **2** or **3** is lit or blinks, the test was unsuccessful and the charging procedure cannot be started/ the charging cable must not be connected to the vehicle. The following test steps are carried out

- The domestic socket outlet is checked to see if the wiring is incorrect
- A check is carried out to see if there is a ground wire connection
- The prerequisites for correct charging are checked
 - » The status displays/Check Control messages are listed in the "Displays" chapter. If Check Control messages appear, they can be reset as follows:
- Disconnect the standard charging cable from the voltage supply by pulling the connector out of the domestic socket outlet.
- Re-insert the plug after 10 seconds.
 - » Critical faults that indicate damage to the standard charging cable are not reset. These faults include:
- Relay welded (device permanently faulty)
- Temperature sensor faulty
- Fault current test negative

DANGER

Use of damaged charging cable.

Injury or damage as a result, for example, of electric shock or fire.

- Do not use damaged charging cables.
 - Immediately discontinue use of damaged charging cables (e.g., if there is damage to the casing or cable).
- Have the fault rectified as soon as possible by an authorized BMW Motorrad retailer.



- Connect the charging cable **2** to the charging socket **1**.
- » The charging cable is electrically locked if standby mode is turned off or the vehicle is being charged.

114 BMW EPOWER

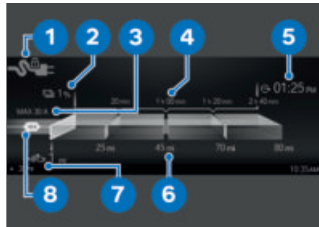
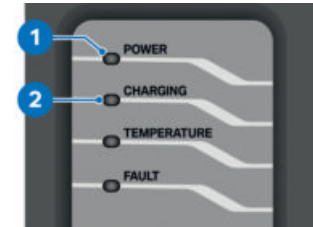

- Pay attention to the displays on the charging cable.
 - » The standard charging cable automatically carries out all necessary test steps. If LED 1 is lit and LED 2 is blinking, the test was successful and the vehicle is being charged.

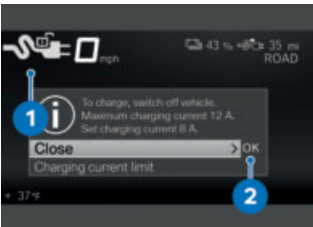

If standby mode is turned on, the note 2 appears. The icon 1 indicates that the charging cable is connected, but the charging process has not yet been started. You can select a charging current limit or start with the charging operation immediately by turning off the vehicle.

The icon 1 for the connector detection status appears. The state of charge 2 and the range 7 are displayed. The charging time prediction 4 in conjunction with the range prediction 6 indicates how long the vehicle has to be charged to achieve a particular expected range. The target time 5 indicates the time by which the vehicle has reached a charge of 100%. The target time is always based on the time set in the vehicle. In addition to the active charging current limit 8, the maximum available charge current level 3 is also displayed if the infrastructure offers a larger current than what has been selected in the settings menu. After a certain period of time, the display is automatically switched to Stand-by-Modus (energy saving mode). The charging operation is continued

–with quick charger^{OE}

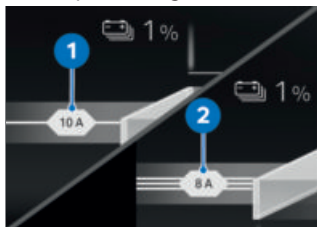

The display shows whether charging is single-phase **1** or three-phase **2**.◀

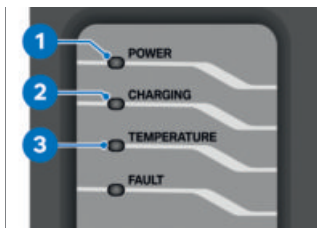

- Pay attention to the displays on the charging cable.
- » If LEDs **1** and **3** are lit, the charging is interrupted because the temperature is too high. If LED **2** is also blinking, the vehicle is slowly being charged more. If LED **1** is lit and LED **3** is blinking, the charging is interrupted because the temperature in the power plug is too high. The following test steps are carried out:

- A check is carried out to see if there is a ground wire connection
- The prerequisites for correct charging are checked
- To display the current state of charge again, briefly press the MENU button.
- » If the charging time is longer than expected, check the configured Charging curr. limit.

End charging procedure Requirement

When ending the charging procedure, it is essential to follow the steps below in the sequence described.

Requirement

If you are charging your vehicle at a charging station, end the charging process at the charging station before detaching the charging cable.

- Turn on standby mode.
- » The charging cable is unlocked at the electric scooter.

116 BMW EPOWER

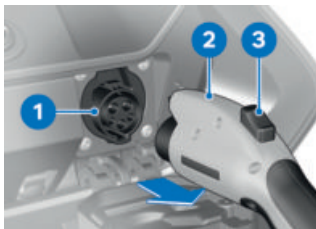

- Press the release button **3** and detach the charging cable **2** from the charging socket **1** on the E-Scooter.



- Attach the charging socket cover **1**.
- Detach the standard charging cable at the domestic socket outlet or the Mode3 charging cable at the charging station, as applicable.
- Place the protective cap on the charging plug.
- Stow the standard charging cable in the helmet compartment or, if the charging cable is firmly attached to the

charging station, put it in the designated place.

Performing emergency release of charging plug

- Remove the front-fairing panel. (➡ 156)

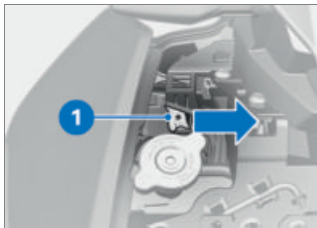

- Push the emergency release lever **1** in the arrow direction, if necessary using a suitable tool.
- » Charging plug unlocked.
- Install the front-fairing panel. (➡ 156)

RIDING

08

SAFETY INSTRUCTIONS	120
OBSERVE CHECKLIST	121
ALWAYS BEFORE RIDING OFF	121
AT EVERY 10TH CHARGING PROCEDURE	122
ESTABLISHING RIDE READINESS	122
RIDING THE ELECTRIC SCOOTER	124
BREAKING IN	127
BRAKES	127
PARKING THE E-SCOOTER	128
FASTENING THE E-SCOOTER FOR TRANSPORTATION	129

SAFETY INSTRUCTIONS

Modifications

ATTENTION

Modifications to the E-Scooter

Damage to the affected parts, failure of safety-relevant functions. Damage caused in this way is not covered by the warranty.

- Do not make any modifications.

Rider's equipment

Do not ride without the correct clothing! Always wear

- Helmet
- Rider's suit
- Gloves
- Boots

This applies even to short journeys, and to every season of the year. Your authorized BMW Motorrad retailer will be happy to advise you and has the correct clothing for every purpose.

WARNING

Seizure of loose textile fabrics, luggage items or straps in open running rotating vehicle parts (wheels, prop shaft)

Risk of accident

- Make sure that no loosely worn textile fabrics can get caught in open, running and rotating vehicle parts.
- Keep luggage items as well as tension belts and lashing straps away from open, running and rotating vehicle parts.

Vehicle load

WARNING

Reduced riding stability caused by overloading and uneven loading

Accident hazard

- Do not exceed the gross weight limit and observe the loading information.
- Adjust spring preload and tire pressure for the current gross vehicle weight.
- Observe the maximum payload of the helmet compartment.

	Payload of the helmet compartment
max 18 lbs (max 8 kg)	

–with topcase^{OA}

- Observe the maximum payload of the topcase.

	Payload of Topcase
max 11 lbs (max 5 kg)◁	

Speed

If you ride at high speed, always bear in mind that various marginal conditions can adversely affect the handling of the E-Scooter:

- Settings of spring struts
- Unevenly distributed load
- Loose clothing
- Insufficient tire pressure
- Tire tread in poor condition
- Attached luggage systems, such as Topcase

Risk of poisoning



WARNING

Inhalation of vapors that are harmful to health

Damage to health

- Do not inhale vapors from operating fluids and plastics.
- Only use the vehicle outdoors.

Modifications



ATTENTION

Modifications to the E-Scooter

Damage to the affected parts, failure of safety-relevant functions. Damage caused in this way is not covered by the warranty.

- Do not make any modifications.

OBSERVE CHECKLIST

- Use the following checklist to check your E-Scooter at regular intervals.

ALWAYS BEFORE RIDING OFF

Requirement

Before every ride:

- Check the charge level of the high-voltage energy storage system.
- Check operation of the brake system.
- Check operation of the lighting and signal system.
- Check tire tread depth. (▮▮▮ 155)
- Check tire pressure. (▮▮▮ 154)
- Make sure topcase and luggage are held securely.

122 RIDING

AT EVERY 10TH CHARGING PROCEDURE

Requirement

At every 10th charging process:

- Check front brake pad thickness. (▣▣▣ 149)
- Check rear brake pad thickness. (▣▣▣ 150)
- Check the front and rear wheel brake fluid level. (▣▣▣ 151)

ESTABLISHING RIDE READINESS

Pre-Ride-Check

After standby mode is turned on, the instrument cluster performs a test of the indicator and warning lights – what we call the "Pre-Ride-Check". Turning on ride readiness before the test is completed will cancel the remainder of the test.

Phase 1

All indicator and warning lights are switched on. After a longer standstill of the vehicle, an animation is displayed during the system start.

Phase 2

The general warning light changes from red to yellow.

Phase 3

All of the indicator and warning lights that have been turned on are turned off in reverse order.

If one of the indicator and warning lights was not turned on:

- Have the malfunction corrected as soon as possible at a specialist workshop, preferably an authorized BMW Motorrad retailer.



Depending on the riding mode or its configuration, the intervention of electronic stability control systems can be restricted.

Possible restrictions are displayed as a pop-up message, e.g. Caution! ABS & DTC setting.

You can find more detailed information regarding electronic stability control systems such as ABS and DTC in the "Technology in detail" chapter.

ABS self-diagnosis

The self-diagnosis routine determines whether BMW Motorrad ABS is ready for operation. The self-diagnosis routine runs automatically when you turn on standby.

Phase 1

» System components are checked when the vehicle is stationary.



blinks.

Phase 2

» System components are checked when the vehicle is being driven.

– ABS self-diagnosis completed. The ABS symbol is no longer displayed.

- Check the display of all indicator and warning lights.



ABS self-diagnosis not completed

The ABS function is not available, as the self-diagnosis function has not been completed. (The E-Scooter must reach a specified minimum speed before the system can check operation of the wheel speed sensors: min 3 mph (min 5 km/h))

If an ABS error is displayed after the ABS self-diagnosis is completed:

- You may continue riding. It must be noted that the availability of the ABS function is limited or it is not available at all.
- Have the fault rectified as soon as possible by an authorized BMW Motorrad retailer.

ASC/DTC self-diagnosis

The self-diagnosis routine is determining whether BMW Motorrad ASC/DTC is ready for operation. The self-diagnosis routine runs automatically when you turn on standby.

Phase 1

» Checking system components capable of diagnosis while vehicle is at a standstill.



flashes slowly.

Phase 2

» Checking system components capable of diagnosis when riding off.



flashes slowly.

124 RIDING

ASC/DTC self-diagnosis completed

- » The ASC/DTC symbol is no longer displayed.
- Watch all warning and indicator lights on the display.



ASC/DTC self-diagnosis not completed

The E-Scooter must reach a specified minimum speed when ride readiness is turned on before the system can check operation of the wheel speed sensors:

min 3 mph (min 5 km/h)

If an ASC/DTC fault is displayed after the ASC/DTC self-diagnosis is completed:

- You may continue riding. It must be noted that the ASC/DTC function is not available.
- Have the malfunction corrected as soon as possible at a specialist workshop, preferably an authorized BMW Motorrad retailer.

E-Scooter ready for operation

After carrying out the Pre-Ride-Check and the ABS self-diagnosis, the E-Scooter is operational for all electricity consumers.



In order to conserve the 12 V battery, only use active power consumers for as long as absolutely necessary and deactivate operating readiness.

RIDING THE ELECTRIC SCOOTER

E-Scooter operational



The E-Scooter is operational when the start button is pressed while the brake is applied. The drive display appears and **READY** is displayed. All systems are operational. Pressing the emergency-off switch will deactivate the E-Scooter.



When temperatures are low, the power output and input are impaired.



In exceptional cases, the high-voltage energy storage system may heat up significantly while the vehicle is not

in motion (i.e. in extreme outside temperatures and direct sunlight). If the high-voltage energy storage system is overheated, the E-Scooter is not ready to ride.

 Very high temperatures (over 95 °F (35 °C)) impede the service life of the battery cells. If the high-voltage energy storage system overheats while riding, the drive power is successively reduced to cool down the high-voltage energy storage system. The power gauge POWER in the instrument cluster decreases during this process. If the temperature continues to rise, park the vehicle until the high-voltage energy storage system has cooled down. If the power gauge drops to 0, the E-Scooter is not ready to ride, and the vehicle comes to a standstill.

Switching on ride readiness

- Turn on standby mode. (▣▣▣▣▶ 54)
- » Pre-Ride-Check is carried out. (▣▣▣▣▶ 122)
- » ABS self-diagnosis is performed. (▣▣▣▣▶ 123)
- » ASC/DTC self-diagnosis is performed. (▣▣▣▣▶ 123)

- Apply the brake.



- Press starter button 1.

 Standby cannot be established while the side stand is extended. If the side stand is extended with standby turned on, standby is disabled.

- » E-Scooter is operational.
- » If the E-Scooter is not operational, the troubleshooting chart may be of assistance. (▣▣▣▣▶ 184)

Riding with ePOWER

WARNING

Reduced awareness of the E-Scooter in electric mode.

Accident hazard

- With driving in electric mode, pedestrians and others on the road may not be aware of the E-Scooter because of its lack of engine noise.
- Drive with particular care.

126 RIDING

Energy recovery through deceleration

The high-voltage energy storage system is partially recharged through energy recovery. During deceleration, the electrical machine functions like a generator and converts kinetic energy into electrical energy.

Deceleration depends on the riding mode and the position of the E-gas electronic throttle twistgrip. The less the E-gas electronic throttle twistgrip is twisted, the greater the deceleration. This recovers energy and charges the high-voltage energy storage system. If the E-gas electronic throttle twistgrip is not twisted at all, the deceleration will be similar to light braking.

Energy can be recovered if the following conditions are met:

- E-Scooter is in motion.
- Speed greater than Approx. 3 mph (Approx. 5 km/h).

Energy cannot be recovered in the following situations:

- The high-voltage energy storage system is completely charged.
- The temperature of the high-voltage energy storage system

is very low or very high. In the winter or summer, energy recovery may not be available temporarily after starting the vehicle.



WARNING

When there is no energy recovery, the electric drive cannot be braked. The E-Scooter could coast further than expected.

Accident hazard

- Always be prepared to brake.

Driving situations for deceleration

If deceleration is likely while driving, this can be used for energy recovery. The following driving situations may be suitable for this purpose:

- Deceleration on a route segment on a slope
- Deceleration before a red light

Avoid late or heavy braking. Instead, decelerate the vehicle using energy recovery.

BREAKING IN

Brake pads

New brake pads must be run in before they achieve their optimum friction force. This reduction in braking effect can be compensated for by exerting greater pressure on the brake levers.



WARNING

New brake pads

Extension of the braking distance, accident hazard

- Brake early.

Tires

New tires have a smooth surface. They must be roughened by breaking in at varying lean angles in a restrained manner. This breaking-in procedure is essential if the tire tread is to achieve maximum grip.



WARNING

Loss of adhesion of new tires on wet roads and at extreme angles

Accident hazard

- Always think well ahead and avoid extreme angles.

BRAKES

How do you achieve the shortest braking distance?

The dynamic load distribution between the front and rear wheel changes during the braking process. The more pressure you apply to the brake, the greater the load transfer to the front wheel. Increases in the load on an individual wheel are accompanied by a rise in the effective brake force that the wheel can provide.

To achieve the shortest possible braking distance, the front wheel brake must be applied quickly and with progressively greater levels of force. This procedure provides ideal utilization of the dynamic load increase to the front wheel. If the brake pressure is applied abruptly and with a lot of force, the dynamic load distribution may not be in line with the increased deceleration, and the brake force cannot be fully transmitted to the road.

128 RIDING

Descending mountain passes



WARNING

Braking only with the rear-wheel brake when descending mountain passes.

Loss of braking action.

Destruction of the brakes caused by overheating.

- Use both front and rear brakes, and make use of energy recovery as well.

For more information about energy recovery, see the "Technology in detail" chapter starting on page (139).

Wet, soiled brakes

Moisture and dirt on the brake discs and the brake pads result in a decrease in the braking effect.

Delayed or poorer braking effect must be expected in the following situations:

- When riding in the rain and through puddles.
- After washing the vehicle.
- When riding on roads spread with salt.
- After working on the brakes due to oil or grease residues.
- When riding on soiled roads or offroad.



WARNING

Poorer braking action due to moisture and dirt

Accident hazard

- Brake until brakes are dry or clean; clean if necessary.
- Brake early until the full braking action is available again.

PARKING THE E-SCOOTER

Side stand

- Turn off ride readiness.



ATTENTION

Poor ground conditions in area of stand

Component damage cause by tipping over

- Always check that the ground under the stand is level and firm.
- Fold out the side stand and park the E-Scooter.
- » When the side stand is folded out, the emergency brake is automatically engaged. This prevents the vehicle from rolling.

**ATTENTION****Loading of the side stand with additional weight**

Component damage cause by tipping over

- Do not sit on the motorcycle when it is parked on the side stands.

- Turn handlebars to left.

Center stand

—with center stand^{OE}

- Turn off ride readiness.

**ATTENTION****Poor ground conditions in area of stand**

Component damage cause by tipping over

- Always check that the ground under the stand is level and firm.

**ATTENTION****Folding in the center stand in case of strong movements**

Component damage cause by tipping over

- Do not sit on the vehicle while it is resting on the center stand.

- Fold out the center stand and prop up the E-Scooter. When doing so, lift the E-Scooter only by the passenger grab handles or the grab handles on the topcase carrier.

FASTENING THE E-SCOOTER FOR TRANSPORTATION

- Protect all component surfaces against which tensioning belts are routed from scratching (e.g. using adhesive tape).

**ATTENTION****Motorcycle tips to the side when raising**

Component damage cause by tipping over

- Secure the motorcycle against tipping to the side, preferably with the assistance of a second person.

130 RIDING

- Push the E-Scooter onto the transportation flat and hold it in position; do not place it on the side stand or center stand.

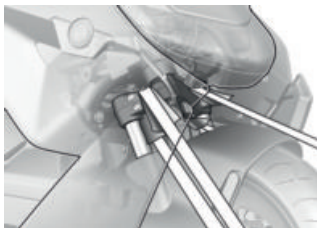

ATTENTION

Pinching of components

Component damage

- Do not pinch components, e.g. brake lines or wiring harnesses.
- Lay tensioning belts at front over lower fork bridge on both sides and tension.



- Secure the right rear tensioning belt at the retaining plate of the footrest.

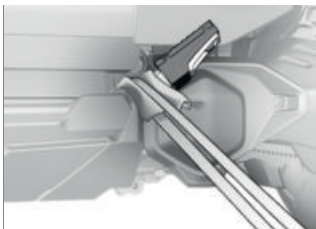

- Secure the rear left tensioning belt at the retaining plate of the footrest.
- Tension all tensioning belts evenly; the E-Scooter should be pulled down with maximum spring compression.

TECHNOLOGY IN DETAIL

09

GENERAL NOTES	134
ANTILOCK BRAKING SYSTEM (ABS)	134
TRACTION CONTROL (ASC/DTC)	137
RECUPERATION STABILITY CONTROL (RSC)	139
RIDING MODE	139
DYNAMIC BRAKE CONTROL	141
TIRE PRESSURE MONITOR (RDC)	142
ADAPTIVE HEADLIGHT	143

GENERAL NOTES

More information on the topic of technology is available at bmw-motorrad.com/technik.

ANTILOCK BRAKING SYSTEM (ABS)

How does ABS work?

The maximum braking force that can be transferred to the road is partially dependent on the coefficient of friction of the road surface. Gravel, ice, snow and wet roads offer a considerably poorer coefficient of friction than a dry, clean asphalt surface. The poorer the coefficient of friction of the road is, the longer the braking distance will be.

If the maximum transferable braking force is exceeded when the driver increases the brake pressure, the wheels begin to lock and driving stability is lost, and a fall can occur. Before this situation occurs, ABS intervenes and adjusts the brake pressure to the maximum transferable braking force. This enables the wheels to continue to turn and maintains riding stability regardless of the road condition.

What happens when rough roads are encountered?

Bumpy or rough roads can briefly lead to a loss of contact between the tires and the road surface, until the transferable braking force is reduced to zero. If the brakes are applied in this situation, the ABS must reduce the brake pressure to ensure riding stability when road contact is restored. At this point, the BMW Motorrad ABS must assume extremely low coefficients of friction (gravel, ice, snow) so that the running wheels turn in every imaginable case and the riding stability is ensured. After detecting the actual conditions, the system adjusts the optimum brake pressure.

Lifting off rear wheel

During extremely heavy and rapid decelerations, however, it is possible under certain circumstances that the BMW Motorrad Antilock Brake System cannot prevent the rear wheel from lifting off the ground. In these cases, the electric scooter can also flip end over end.

**WARNING****Lifting off of the rear wheel due to heavy braking**

Accident hazard

- When braking heavily, bear in mind that the ABS control cannot always be relied on to prevent the rear wheel from lifting off the ground.

What are the design characteristics of the BMW Motorrad ABS?

The BMW Motorrad ABS ensures riding stability on any surface within the limits of riding physics.

From a speed greater than 2.5 mph (4 km/h), the BMW Motorrad ABS can ensure riding stability on any surface within the limits of riding physics. At lower speeds, the BMW Motorrad ABS cannot provide optimal support on all surfaces due to system limitations.

The system is not optimized for the special requirements encountered under the extreme conditions of competitive off-road and racetrack use.

Special situations

To detect the tendency of the wheels to lock up, the speeds of the front and rear wheel are compared. If implausible values are detected over a longer period of time, the ABS function is switched off for safety reasons, and an ABS error is displayed. A self-diagnosis must be completed before the fault memory entry can be displayed. Apart from problems with the BMW Motorrad ABS, unusual riding conditions can also cause a fault memory entry to be generated:

- Riding on the rear wheel (wheelie) for an extended period.
- Rear wheel spinning in place with front wheel brake engaged (burn out).
- Rear wheel locked-up for a longer period of time by engine brake, e.g. when riding downhill on slippery surfaces.

Should a Check Control message occur due to an unusual driving condition, the ABS function can be reactivated by switching standby mode off and then on again.

136 TECHNOLOGY IN DETAIL

How important is regular preventive maintenance?



WARNING

Brake system not regularly serviced

Accident hazard

- To ensure that the BMW Motorrad ABS is in a properly maintained condition, it is vital that the specified service intervals are kept to.

Reserves for safety

The potentially shorter braking distances that the BMW Motorrad ABS permits must not be used as an excuse for careless riding. ABS is primarily a means of ensuring a safety margin in genuine emergencies.

Be careful on curves! When you apply the brakes on a curve, the motorcycle's weight and momentum take over and even the BMW Motorrad ABS is unable to counteract their effects.

Further development of ABS to ABS Pro

—with riding modes Pro^{OE}

In the past, the BMW Motorrad ABS system provided for a very high level of safety while braking during straight-ahead riding. Now ABS Pro also offers increased safety even when braking in curves. ABS Pro prevents the wheels from locking up, even if the brakes are applied quickly. ABS Pro reduces abrupt changes in steering forces, especially during shock braking, and therefore decreases the risk of the vehicle lifting off the ground inadvertently.

ABS control

From a technical standpoint, ABS Pro adapts the ABS control to the angle of inclination of the electric scooter depending on the respective riding situation. Signals for the roll and yaw rate and the lateral acceleration are used to determine the inclination of the electric scooter.

With an increasing inclination, the brake pressure gradient is increasingly limited at the start of braking. This results in a slower pressure buildup. In

addition, the pressure modulation in the range of the ABS control is more uniform.

Advantages for the rider

The advantages of ABS Pro for the rider are sensitive response and high braking and riding stability with the best possible deceleration, even in curves.

TRACTION CONTROL (ASC/DTC)

How does traction control work?

Traction Control is available in two versions

- **Without** taking the angle into account: Automatic Stability Control Automatic Stability Control (ASC)
- ASC is a rudimentary function intended to prevent falls.
- **With** taking the angle into account: Dynamic Traction Control (DTC)
- The additional inclined position and acceleration information enables the DTC to make more precise and comfortable adjustments.

The traction control compares the wheel centrifugal velocities of the front and rear wheels. The slip, and with it the stability reserves at the rear wheel,

are determined from the speed difference. The engine control adapts the engine torque when the slip limit is exceeded. The BMW Motorrad ASC/DTC is designed as an assistance system for the rider and for riding on public roads. The extent to which the rider affects ASC/DTC control can be considerable (weight shifts when cornering, loose luggage on the motorcycle), especially when approaching the limits imposed by the laws of physics.



WARNING

Risky riding style

Accident hazard despite ASC/DTC

- The rider is always responsible for adapting his/her driving style.
- Do not reduce the system's extra safety margin with careless riding or unnecessary risks.

Special situations

As the lean angle increases, the capacity to accelerate is also increasingly limited by the laws of physics. This can result in reduced acceleration when coming out of very tight curves.

138 TECHNOLOGY IN DETAIL

To detect spinning or slipping away of the rear wheel, the speeds of the front and rear wheel are compared and the angle with DTC is taken into account compared to ASC, among other measures.

–with riding modes Pro^{OE}

If the values for the lean angle are detected to be implausible for a long period, a substitute value is used for the angle, or the DTC function is turned off. In these cases, a DTC error is displayed. A self-diagnosis must be completed before the fault memory entry can be displayed.

Under the following unusual riding conditions, BMW Motorrad Traction Control may be deactivated automatically.

Unusual riding conditions:

- Riding on the rear wheel (wheelie) for an extended period.
- Rear wheel spinning in place with front wheel brake engaged (burn out).
- Warm-up on an auxiliary stand



Minimum speed for DTC activation

min 3 mph (min 5 km/h)

–with riding modes Pro^{OE}

If the front wheel loses contact with the ground under extreme acceleration, the DTC reduces the engine torque in all riding modes until the front wheel makes contact with the ground again.

BMW Motorrad recommends that you respond to the front wheel lifting off by easing off the E-gas electronic throttle twistgrip somewhat to return to a stable riding condition as quickly as possible.

In the ECO riding mode, the DTC setting corresponds to the ROAD riding mode.

In the RAIN, ROAD and DYNAMIC riding modes, the DTC setting corresponds to the riding mode.

RECUPERATION STABILITY CONTROL (RSC)

How does the energy recovery stability control work?

The purpose of the energy recovery stability control is to safely prevent unstable riding conditions that are related to excess energy recovery torque at the rear wheel. Depending on the road condition and riding dynamics, excess energy recovery torque can make the slip at the rear wheel increase severely and impede riding stability. The energy recovery stability control limits excess slip at the rear wheel to a safe target slip dependent on the riding mode.

Causes of excess slip at the rear wheel:

- Riding in energy recovery operation on road with low coefficient of friction (e.g. wet leaves).
- Hard brake onset in sporty riding style.

Like the BMW Motorrad DTC traction control, the energy recovery stability control compares the wheel centrifugal velocity of the front and rear wheel, which are calculated

from the wheel RPM and the tire radius. The energy recovery stability control can determine the slip, and therefore the stability reserve, on the rear wheel using the speed difference.

If the slip exceeds the respective limit value, the energy recovery torque is reduced. The slip is reduced, and the vehicle is stabilized.

Effect of the energy recovery stability control

- In ECO, RAIN and ROAD riding modes: Maximum stability.
- with riding modes Pro^{OE}
- In DYNAMIC riding mode: Reduced intervention when compared to the RAIN and ROAD riding modes.

RIDING MODE

Selection

To adapt the electric scooter to the road condition and the desired riding experience, you can select from the following riding modes:

140 TECHNOLOGY IN DETAIL

Series

- ECO
- RAIN
- ROAD (standard mode)

-with riding modes Pro^{OE}

With Pro riding modes

- DYNAMIC

For each of these riding modes, there is a coordinated setting for the ABS and DTC systems, energy recovery stability control, throttle response and brake energy recuperation.

Throttle response

- In ECO riding mode: restrained throttle response and reduced torque.
- In the RAIN riding mode: Soft throttle response.
- In the ROAD riding mode: Optimal throttle response.
- with riding modes Pro^{OE}
- In the DYNAMIC riding mode: Direct throttle response.

Energy recovery

- In the RAIN and ROAD riding modes: medium energy recovery by braking the vehicle.
- In the ECO riding mode: maximum energy recovery by braking the vehicle.

- with riding modes Pro^{OE}
- In the DYNAMIC riding mode: maximum energy recovery by braking the vehicle.

ABS

- Rear wheel lift-off detection is active in all riding modes.
- In the ECO, RAIN, ROAD and DYNAMIC riding modes, the ABS is set for road use.

-with riding modes Pro^{OE}

ABS Pro

- ABS Pro is available in all riding modes to the full extent. The stand-up tendency the E-Scooter has when braking in curves is reduced to a minimum.

DTC

Tires

- DTC is attuned for road use with road tires in all riding modes.

Riding stability

- In the RAIN riding mode, the DTC intervenes early enough to ensure maximum riding stability is achieved.
- In the ECO and ROAD riding modes, the intervention of the DTC occurs later than in the RAIN riding mode. Rear wheel spinning without trac-

tion is avoided wherever possible.

- In the DYNAMIC riding mode, the DTC intervenes at a later point than in the ROAD riding mode. Rear wheel spinning without traction is avoided wherever possible.
- In all riding modes, the front wheel is prevented from lift-off.

Switchover

Riding modes can be changed during a standstill with standby mode turned on or while riding.

First, the desired riding mode is preselected. The switchover does not take effect until the affected systems are in the required state.

The Selection menu does not disappear from the display until the riding mode has been switched over.

ECO mode

Maximum energy recovery as the vehicle decelerates with limited acceleration is achieved in ECO mode. ECO mode is designed for maximum range.

DYNAMIC BRAKE CONTROL

-with riding modes Pro^{OE}

Dynamic Brake Control function

The Dynamic Brake Control function helps the rider in the event of emergency braking.

Detection of emergency braking

-Emergency braking is detected when the front wheel brake is applied quickly and with force.

Behavior during emergency braking

-If emergency braking is applied at a speed of more than min 6 mph (min 10 km/h), then in addition to the ABS function the Dynamic Brake Control function will also be activated.

Behavior in the event of accidental actuation of the E-gas electronic throttle twistgrip

-If the E-gas electronic throttle twistgrip is accidentally actuated during emergency braking (twist grip position >5%), the intended braking effect is ensured by the Dynamic Brake Control ignoring the opening process of the E-gas

142 TECHNOLOGY IN DETAIL

electronic throttle twistgrip.

This ensures the effectiveness of emergency braking.

- If the gas is shut off (throttle position <5%) during the intervention of the Dynamic Brake Control, the engine torque required by the ABS brake system will be restored.
- If the emergency braking is stopped and the E-gas electronic throttle twistgrip is still under actuation, the Dynamic Brake Control reduces the electrical machine torque as required by the rider in a controlled manner.

TIRE PRESSURE MONITOR (RDC)

- with tire pressure monitor (TPM)^{OE}

Function

A sensor located in each tire monitors the air temperature and the tire pressure and transmits this information to the control unit.

The sensors are equipped with a centrifugal controller, which does not enable the transmission of the measured values until the minimum speed is exceeded for the first time.



Minimum speed for the transmission of the RDC measured values:

min 19 mph (min 30 km/h)

Before initial reception of the tire pressure, -- is shown in the display for each tire. The sensors continue to transmit the measured readings for some time after the vehicle comes to a stop.



Transmission time of the measured values after vehicle standstill:

min 15 min

If an RDC control unit is installed but the wheels have no sensors, a fault memory entry is generated.

Tire inflation pressure ranges

The RDC control unit distinguishes between three inflation pressure ranges matched to the motorcycle:

- Tire pressure within the permissible tolerance.
- Tire pressure in the limit range of the permissible tolerance.
- Tire pressure outside the permissible tolerance.

Temperature compensation

The tire pressure is temperature-dependent: it increases or decreases together with the tire air temperature. The tire temperature is dependent on the outside temperature, the riding style and the length of the journey.



The tire pressures are shown in the TFT display with temperature compensation and are always based on the following tire air temperature:

68 °F (20 °C)

Tire pressure gauges at gas stations do not make any compensation for the tire air temperature, the tire pressure indicated depends on the temperature of the air in the tire. As a result, in most cases the values displayed there do not match the values shown in the TFT display.

Tire pressure adjustment

Compare the RDC value in the TFT display with the value on the back cover of the Rider's Manual. The difference between the two values must be compensated with the tire inflation pressure tester at the filling station.



Example

According to the Operating Instructions, the tire pressure should have the following value:

36.3 psi (2.5 bar)

The following value is displayed in the TFT display:

33.4 psi (2.3 bar)

The shortfall is thus:

2.9 psi (0.2 bar)

The tester at the filling station shows:

34.8 psi (2.4 bar)

To produce the correct tire pressure, this must be increased to the following value:

37.7 psi (2.6 bar)

ADAPTIVE HEADLIGHT

—with Adaptive Lights^{OE}

How do the adaptive headlights work?

The standard installed dimming unit in the headlight consists of two reflectors that generate low-beam headlights using LED. Ride height sensors at the front and rear wheel suspension provide data for continuous headlight range control. Thanks to the pitching

144 TECHNOLOGY IN DETAIL

compensation, the light always illuminates the optimal, preset area when riding on straight stretches of road, regardless of the riding conditions and load status. Using Adaptive Headlights, the dimming unit additionally rotates around an axis, depending on the angle, and compensates for the angle of roll of the vehicle. The angle of rotation is $70^\circ (\pm 35^\circ)$.

In addition to the pitching compensation, therefore, the low-beam headlight is adjusted to compensate for the lean angle during riding. Both movements are overlaid so that a highlight in the curve results. This results in significantly improved illumination of the road when riding around curves and thus an enormous increase in active safety.

MAINTENANCE

10

GENERAL NOTES	148
STANDARD TOOL KIT	149
BRAKE SYSTEM	149
COOLANT	153
TIRES	154
RIMS AND TIRES	155
LIGHT SOURCES	156
TRIM PANEL COMPONENTS	156
BATTERY	158
FUSES	162
DIAGNOSTIC SOCKET	164

GENERAL NOTES

The "Preventive maintenance" chapter describes work for checking and replacing wear parts that can be performed with a minimum of effort. If specific tightening torques are to be taken into account for installation, these are listed. An overview of all required tightening torques is contained in the chapter "Technical data".

Microencapsulated screws

The microencapsulation is a chemical threadlocker. An adhesive is used to create a solid connection between screw and nut or component. Microencapsulated screws, therefore, are suitable for single use only. After removal, the internal thread must be cleaned to remove adhesive. During installation, a new microencapsulated screw must be used. Therefore, before removal, ensure that you have suitable tools for cleaning the thread and have a replacement screw. If you carry out the work improperly, the locking function of the screw might no longer be guaranteed, which puts you in danger!

Special tools and thorough specialized knowledge are required to carry out some of the work described here. If you are in doubt, consult a repair shop, preferably your authorized BMW Motorrad retailer.



DANGER

Improperly performed preventive maintenance and repair procedures.

Mortal hazard from electric shock.

- Special tools and thorough specialized knowledge are required to carry out tasks not described here.
- Only carry out tasks that are described in this chapter. Carry out the described tasks only with standby turned off. If in doubt, contact a specialist workshop, preferably an authorized BMW Motorrad retailer.

**DANGER****Working with the high-voltage system.**

Risk of death

- The vehicle high-voltage system is a self-contained system. It is safe as long as no work is performed on the technical components.
- Modifications and work on the high-voltage system should only be performed by a BMW Motorrad partner with appropriately trained staff.

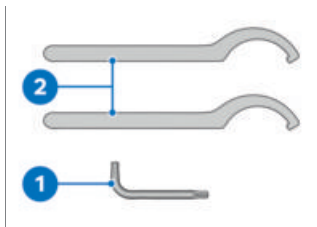
STANDARD TOOL KIT

- 1** TORX wrench, T25
– Remove trim panel components.
- 2** Hook wrench
– Adjust the spring preload on the suspension strut.
(101)

BRAKE SYSTEM**Checking brake function**

- Operate right brake lever.
» A clear resistance point can be felt.
 - Operate left brake lever.
» A clear resistance point can be felt.
 - To check the parking brake, fold out the side stand and push the E-Scooter back and forth.
» The E-Scooter will not move.
- If no clear resistance points can be felt and the scooter can be moved:
- Have the brakes checked by an authorized BMW Motorrad retailer.

Checking the front brake pad thickness

- Park the electric scooter, making sure it is on level and firm ground.

150 MAINTENANCE



- Visually inspect the left and right brake pads to ascertain their thickness. Direction of view: from rear, looking at brake pads **1**.

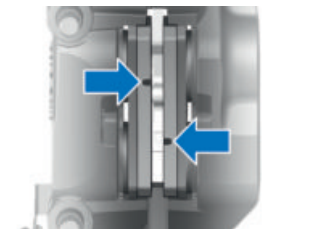

Front brake-pad wear
limit

min 0.22 in (min 5.6 mm)
(Friction lining with carrier
plate)

If the wear marks, i.e. the grooves, are no longer clearly visible:



WARNING

Dropping below the minimum pad thickness

Reduced braking action, damage to the brake

- In order to ensure the operating reliability of the brake system, make sure that the brake pads are not worn beyond their minimum thickness.
 - Have brake pads renewed at a repair shop, preferably an authorized BMW Motorrad retailer.
 - BMW Motorrad recommends only installing genuine brake pads.
- #### Checking the rear brake pad thickness
- Park the E-Scooter, making sure it is on level and firm ground.

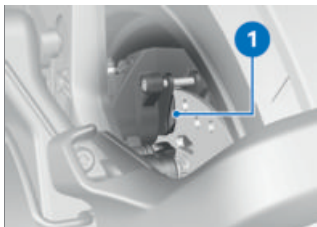

- Conduct a visual inspection of the brake pad thickness. Direction of view: from rear toward brake caliper **1**.

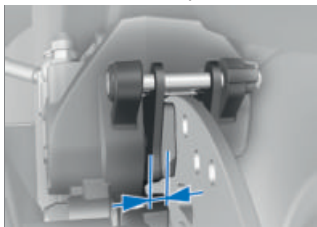

 Rear brake-pad wear limit

min 0.18 in (min 4.5 mm)
(Friction lining with carrier plate)

If the wear marks have been reached:

WARNING

Dropping below the minimum pad thickness

Reduced braking action, damage to the brake

- In order to ensure the operating reliability of the brake system, make sure that the brake pads are not worn beyond their minimum thickness.

- Have brake pads renewed at a repair shop, preferably an authorized BMW Motorrad retailer.
- BMW Motorrad recommends only installing genuine brake pads.

Checking the front and rear wheel brake fluid level

- The brake fluid level can be checked at the sight glasses of the brake fluid reservoirs. The brake fluid reservoir for the front wheel brake is on the right; the brake fluid reservoir for the rear wheel brake is on the left.

152 MAINTENANCE

WARNING

Insufficient or contaminated brake fluid in the brake fluid reservoir

Considerably reduced braking power caused by air, dirt or water in the brake system

- Stop riding immediately until fault is rectified.
 - Check brake fluid level regularly.
 - Make sure that the lid of the brake fluid reservoir is cleaned before opening.
 - Make sure that brake fluid is used from a sealed container only.
-
- Park the E-Scooter, making sure it is on level and firm ground.
 - Align the handlebars so that the brake fluid reservoir is positioned horizontally.



- Read off the brake fluid level from the sight glass **1** of the left/right brake fluid reservoir.

 The brake fluid level in the brake-fluid reservoir drops due to brake pad wear.



 Brake fluid level

Brake fluid, DOT4

The brake fluid level must not fall below the **MIN** mark. (Brake fluid reservoir horizontal)

If the brake fluid level falls below the approved level:

- Have the fault rectified as soon as possible by a specialist workshop, preferably an authorized BMW Motorrad retailer.

COOLANT

Checking the coolant level

- Park the E-Scooter, making sure it is on level and firm ground.
- Remove the front-fairing panel. (→ 156)

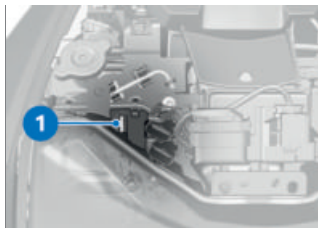

- Check the coolant level **1** visually.



 Target coolant level in the expansion tank

Between **MIN-** and **MAX-** mark (when the coolant circuit is cold)

If the coolant level drops below the permitted level:

- Top up the coolant or have it topped up by an authorized BMW Motorrad retailer as quickly as possible.
- Install the front-fairing panel. (→ 156)

Topping up coolant



WARNING

Opening the radiator cap

Risk of burning

- Do not open the radiator cap when it is hot.
- Check the coolant level exclusively at the expansion tank and top up if necessary.

154 MAINTENANCE

- Remove the front-fairing panel. (➡ 156)
- Let cool down drivetrain and cooling system.

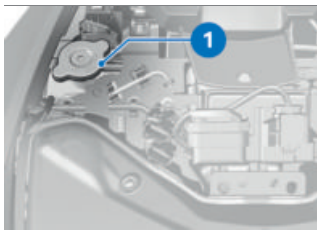

- Open the cap **1**.
- Top up coolant to specified level.



Coolant frost resistance

min -13 °F (min -25 °C)



Coolant top-up quantity

0.1 quarts (0.07 l)

- Check the coolant level. (➡ 153)
- Close the expansion tank cap.
- Install the front-fairing panel. (➡ 156)

TIRES

Checking tire pressure



WARNING

Incorrect tire inflation pressure.

Deteriorated driving characteristics of the Scooter. Reduction of the life of the tires.

- Ensure proper tire inflation pressure.



WARNING

Automatic opening of vertically installed valve inserts at high speeds

Sudden loss of tire inflation pressure

- Use valve caps with rubber sealing ring and screw on firmly.

- Check tire pressure against data below.



Front tire pressure

33.4 psi (2.3 bar) (One-up mode, with cold tires)

33.4 psi (2.3 bar) (Two-up mode with load, with cold tires)

 Rear tire pressure
36.3 psi (2.5 bar) (One-up mode, with cold tires)
36.3 psi (2.5 bar) (Two-up mode with load, with cold tires)

If tire pressure is too low:

- Correct the tire pressure.

RIMS AND TIRES

Checking rims

- Park the E-Scooter, making sure it is on level and firm ground.
- Visually inspect rims for defects.
- Have damaged rims checked by an authorized BMW Motorrad retailer and, if necessary, renewed.

Checking tire tread depth



WARNING

Riding with heavily worn tyres

Risk of accident due to poorer rideability

- If necessary, replace the tyres before the legally specified minimum tread depth is reached.

- Park the E-Scooter, making sure it is on level and firm ground.
- Measure tire tread depth in main tread grooves with wear marks.



Tread wear marks are integrated into the main grooves on every tire. If the tire tread has worn down to the level of the marks, the tire is completely worn. The locations of the marks are indicated on the edge of the tire, e.g. by the letters TI, TWI or by an arrow.

When the minimum tread depth is reached:

- Replace the worn tire.

Tire recommendation

For every tire size, BMW Motorrad has tested and approved certain tire brands as roadworthy. BMW Motorrad cannot evaluate the suitability of any other tires, and therefore cannot take responsibility for their riding safety.

BMW Motorrad recommends only using the tires tested and approved by BMW Motorrad. Your authorized BMW Motorrad retailer can provide you with more detailed information.

156 MAINTENANCE

LIGHT SOURCES

Replacing the LED light source



WARNING

Overlooking the vehicle in traffic due to a defective light source on the vehicle

Safety risk

- Replace defective light sources as quickly as possible. For details please contact a specialist service facility, preferably an authorized BMW Motorrad Retailer.

All light sources on the vehicle are LED light sources. The service life of the LED light sources is longer than the assumed service life of the vehicle. If an LED light source is faulty, please contact a repair shop, preferably an authorized BMW Motorrad retailer.

TRIM PANEL COMPONENTS

Removing the front-fairing panel



- Pull the front-fairing panel **1** forward by the handle centered under the windshield for this purpose.
- Detach the front-fairing panel **1** from the detents **2**.
- Remove the front-fairing panel **1** in the forward direction.

Installing the front-fairing panel

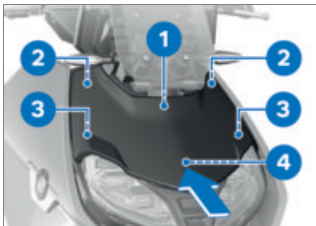

- Position front-fairing panel **1** in arrow direction.

- Feed in front-fairing panel **1** using the guides **3** and **4**.
- Clip the front-fairing panel **1** into the clips **2** with gentle pressure.

Removing side trim panel

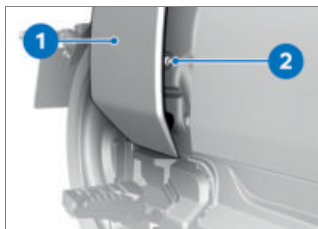

- Remove screw **2**.
- Remove side trim panel **1**.



- Remove the battery cover **1** in the arrow direction.
- Remove screws **2**.

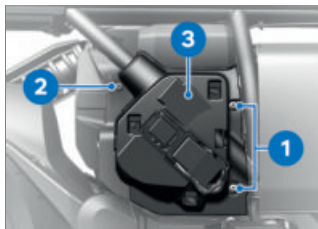

- Remove screws **1**.
- Push back the trim panel component and remove the screw **2**.
- Remove the cover **3**.

Installing side trim panel

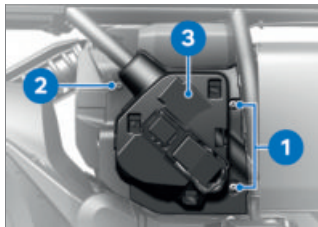

- Position cover **3**.
- Push back the trim panel component and install the screw **2**.
- Install screws **1**.

158 MAINTENANCE

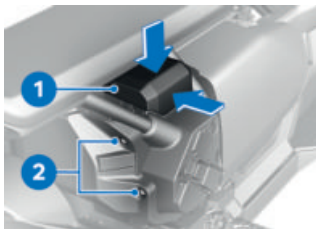

- Install screws **2**.
- Position battery cover **1**.
- Push the battery cover **1** in arrow direction with pressure from above; the detent must snap in audibly.
- Check the battery cover **1** for firm fit.

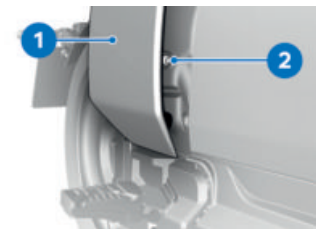

- Snap in the side trim panel **1** with the detents.
- Install screw **2**.

BATTERY

General notes

Correct maintenance combined with proper charging and storage procedures extends the 12 V battery's service life, and is also required for warranty claims.

Compliance with the points below is important in order to maximize the 12 V battery life:

- Keep the surface of the battery clean and dry.
- Be sure to read and comply with the instructions for charging the battery on the following pages.
- Do not turn the battery upside down.

Recharging function

If the state of charge of the 12 V battery falls below a defined threshold value, the recharging function is activated. The 12 V battery is then recharged by the high-voltage battery via the DC/DC converter. This ensures a sufficient state of charge of the 12 V battery.

The recharging function is active in the following situations:

- While the vehicle is in motion: The 12V battery is recharged if necessary.

- During the charging process:
The 12 V battery is recharged in addition to the high-voltage battery.
- During periods of parking:
The state of charge of the 12V battery is checked every other day and recharged if necessary. During recharging, noises of the fan and coolant pump may be audible.

If the 12 V battery had to be recharged three times in a row while parked for an extended period, On-board battery state. No restrictions. Have battery checked by a specialist workshop. appears when you turn on standby mode. Further information in the "Displayed values" chapter.

If the state of charge of the high-voltage battery falls below a critical threshold value, the 12 V battery cannot be recharged. A sufficient state of charge of the high-voltage battery must be ensured so that the recharging function can always be activated as necessary.

Charge 12 V battery



ATTENTION

Charging of the connected 12V battery on the battery terminals

Damage to the vehicle's electronics

- Disconnect the 12V battery before charging on the battery terminals.



ATTENTION

Charging a fully discharged 12V battery using the 12V power socket

Damage to vehicle electronics

- A fully discharged 12V battery (battery voltage less than 12V; indicator lights and multifunction display remain off when ignition is switched on) must always be charged directly at the terminals of the battery when **disconnected**.



ATTENTION

Unsuitable chargers connected to the power socket

Damage to charger and vehicle electronics

- Use suitable BMW chargers. The correct charger is available through your authorized BMW Motorrad retailer.

- Charge connected battery via onboard power socket.



The motorcycle's onboard electronics know when the battery is fully charged. The onboard socket is switched off when this happens.

- Comply with operating instructions of charger.



If you are unable to charge the battery via the onboard power socket, you may be using a charger that is not compatible with your electric scooter's electronics. In this case, charge the battery directly from the terminals of the battery disconnected from the vehicle.

The E-Scooter cannot be driven or operated. Check whether the 12 V battery is discharged completely:

- Turn on standby mode.

( 54)

» Observe the TFT display:

-If the TFT display remains off when standby mode is turned on, the battery is completely discharged. The disconnected 12 V battery must be charged directly via the terminals.

-If the TFT display is turned on, the 12 V battery is not yet completely discharged. The connected 12V battery can be charged via the 12 V socket.

- Turn off standby mode.

( 55)

Charging disconnected battery

- Charge battery using a suitable charger.
- Comply with operating instructions of charger.
- Once battery is fully charged, disconnect charger's terminal clips from battery terminals.

Replacing 12 V battery

—with anti-theft alarm system (DWA)^{OE}

- Turn off the anti-theft alarm system if necessary. ◀
- Turn off standby mode.
- Remove side panel. (▶▶ 157)

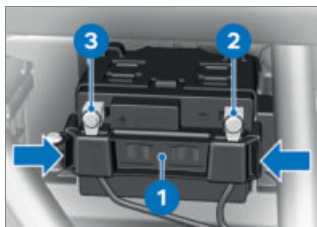

- Push together the left and right clamps on the retainer 1 and remove it.



ATTENTION

Incorrect battery disconnection

Danger of short circuit

- Follow the disconnection sequence.

- Remove the screw 2 and detach the negative battery cable.
- Remove the screw 3 and detach the positive battery cable.
- Remove 12 V battery from battery carrier.

- Push 12 V battery into the battery carrier.

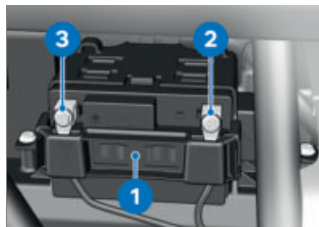

- Install the retainer 1 on the 12 V battery.



ATTENTION

Incorrect battery connection

Danger of short circuit

- Follow the installation sequence.
- Position positive battery cable and install screw 3.
- Position negative battery cable and install screw 2.
- Install side panel. (▶▶ 157)

162 MAINTENANCE

FUSES

Replacing the main fuse



ATTENTION

Bypassing defective fuses

Risk of short circuit and fire

- Do not bypass defective fuses.
 - Replace defective fuses with new fuses.
- Turn off standby mode.
 - Park the E-Scooter, making sure it is on level and firm ground.
 - Remove side panel. (▶▶▶ 157)

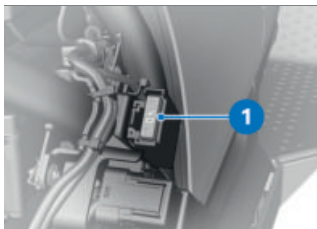

- Replace faulty fuse **1**.

 If the fuses blow frequently, have the electrical system checked by an authorized specialized workshop, preferably an authorized BMW Motorrad retailer.



Main fuse

40 A (Main fuse)

- Install side panel. (▶▶▶ 157)

Replacing fuses

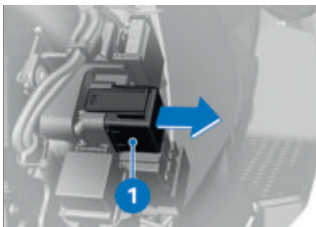

- Turn off standby mode.
- Remove side panel. (▶▶▶ 157)
- Pull off the fuse box **1**.

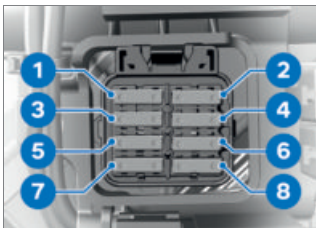

ATTENTION

Bypassing defective fuses

Risk of short circuit and fire

- Do not bypass defective fuses.
- Replace defective fuses with new fuses.

- Replace faulty fuses **1** to **8** according to their assignment.

 If the fuses blow frequently, have the electrical system checked by an authorized specialized workshop, preferably an authorized BMW Motorrad retailer.



Fuse 1

15 A (EME, relay terminal 30 switched)



Fuse 2

7.5 A (Terminal 30B, drive electronics, Antilock Braking System (ABS), sensor box, seat heating, USB charging compartment, TPM, storage compartments)



Fuse 3

10 A (EME)



Fuse 4

7.5 A (Terminal 30, cut-off relay terminal 30B, anti-theft alarm system, vehicle lock, instrument cluster, on-board charger, diagnostic connector)



Fuse 5

7.5 A (Terminal 30C, multifunction switch left, high-voltage safety plug, EME, on-board charger)



Fuse 6

Not in use



Fuse 7

Not in use



Fuse 8

Not in use

- Insert the fuse box.
- Install side panel. (→ 157)

164 MAINTENANCE

DIAGNOSTIC SOCKET

Detaching the diagnostic connector



CAUTION

Incorrect procedure when disconnecting the diagnostic socket for onboard diagnosis

Vehicle experiences malfunctions

- Do not have the diagnostic socket disconnected except during BMW Motorrad service by a specialist workshop or other authorized persons.
- Have work carried out by appropriately trained personnel.
- Observe the specifications of the vehicle manufacturer.

- Remove the front-fairing panel. (▮▮▮ 156)

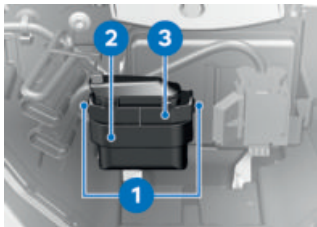

- Press locks **1** on both sides.

- Detach the diagnostic socket **2** from the holder **3**.
 - » The interface for the diagnostics and information system can be connected to the diagnostic connector **2**.

Fastening the diagnostic connector

- Disconnect the interface for the diagnostics and information system.

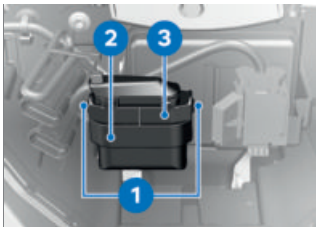

- Insert the diagnostic socket **2** into the holder **3**.
 - » The locking mechanisms **1** engage on both sides.
- Install the front-fairing panel. (▮▮▮ 156)

ACCESSORIES

11

GENERAL NOTES	168
SOCKETS	168
TOPCASE	169

GENERAL NOTES



CAUTION

Use of products from other manufacturers

Safety risk

- BMW Motorrad cannot examine or test each product of outside origin to ensure that it can be used on or in connection with BMW motorcycles without constituting a safety hazard. Nor is this guarantee provided when the official approval of a specific country has been granted. Tests conducted by these instances cannot make provision for all operating conditions experienced by BMW motorcycles and, consequently, they are not sufficient in some circumstances.
- Use only parts and accessories approved by BMW for your motorcycle.

The safety, function and suitability of the parts and accessory products have been thoroughly tested by BMW. Therefore, BMW assumes responsibility for these products. BMW shall not be held liable for un-

approved parts and accessory products of any kind.

Comply with the legal requirements for any modifications.

Consult the road traffic licensing regulations of your country.

Your authorized

BMW Motorrad retailer

offers you qualified advice for choosing original BMW parts, accessories and other products.

More information on the topic of accessories is available at:

bmw-motorrad.com/equipment

SOCKETS

Connecting electrical devices

- Standby mode must be turned on before electrical devices connected to the on-board power sockets can be operated.
- The sockets are supplied with current for only 60 seconds after standby mode is turned off.

Operating electrical accessories

The battery capacity is not monitored when 12 V sockets are in use. If accessory devices are operated for an extended period of time without the high-voltage energy

storage system turned on, the 12 V battery may be fully discharged. As a result, standby mode of the E-Scooter is no longer guaranteed.

Cable layout

- The cables from the on-board sockets to the auxiliary devices must be routed in such a way that they do not impede the rider.
- Cable layout must not restrict the steering angle and the handling characteristics.
- Cables must not be trapped.

TOPCASE

-with topcase^{OA}

Opening topcase

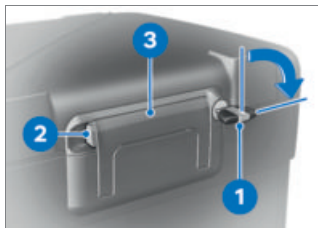

- Turn the key **1** clockwise.
- Press and hold the yellow lock **2** and open the carrying handle **3**.



- Push the yellow button **1** forward and open the topcase lid at the same time.

Adjusting topcase volume

- Open topcase and empty it.



- Lock swivel arm **1** into its foremost position to obtain the largest volume.
- Lock swivel arm **1** as far back as it goes to obtain the smallest volume.
- Close topcase.

 Topcase volume

6.6...9.2 gal (25...35 l)

170 ACCESSORIES

Closing topcase

- Close topcase lid forcefully.



ATTENTION

Folding down the carrying handle when the case is locked

Damage to the locking tab

- Before folding down the carrying handle, make sure that the slot of the topcase lock is vertical.
- Shut the carrying handle **1**.
 - » Carrying handle audibly engages.
- Turn the key **2** counterclockwise and detach.

Removing the topcase



- Turn the key **1** clockwise.
- Press and hold the yellow lock **2** and open the carrying handle **3**.



- Pull back red lever **1**.
 - » Locking mechanism **2** springs open.
- Fully open the locking mechanism.
- Remove the topcase from the holder by its carrying handle.

Installing the topcase



- Pull back red lever **1**.
» Locking mechanism **2** springs open.
- Fully open the locking mechanism.



- Mount topcase onto the front brackets **1** of the topcase retaining plate.
- Push the rear of the topcase onto the topcase retaining plate.



- Push locking mechanism **1** forward until you feel resistance.
- Then push forward locking mechanism and red release lever **2** at the same time.
» The locking mechanism engages.

172 ACCESSORIES



ATTENTION

Folding down the carrying handle when the case is locked

Damage to the locking tab

- Before folding down the carrying handle, make sure that the slot of the case lock is perpendicular to the direction of travel.

- Shut the carrying handle **1**.
» Carrying handle audibly engages.
- Turn the key **2** counterclockwise and detach.

Maximum payload



Payload of Topcase

—with topcase^{OA}

max 11 lbs (max 5 kg)◁

CARE

12

CARE PRODUCTS	176
WASHING THE VEHICLE	176
CLEANING SENSITIVE VEHICLE PARTS	177
CARE OF PAINTWORK	178
PAINT PRESERVATION	179
STORING THE E-SCOOTER	180
PUTTING THE E-SCOOTER INTO OPERATION	180

CARE PRODUCTS

BMW Motorrad recommends that you use cleaning and care products available at your authorized BMW Motorrad retailer. BMW Care Products have been materials tested, lab-tested, and field tested and provide optimum care and protection for the materials used in your vehicle.



ATTENTION

Use of unsuitable cleaning and care agents

Damage to motorcycle parts

- Do not use any solvents such as nitro thinners, cold cleaners, fuel or similar, and do not use cleaning agents that contain alcohol.



ATTENTION

Use of highly acidic or alkaline cleaning agents

Damage to motorcycle parts

- Observe the dilution ratio on the packaging of the cleaning agents.
- Do not use highly acidic or alkaline cleaning agents.

WASHING THE VEHICLE

BMW Motorrad recommends that you use BMW Insect Remover to soften and wash off insects and stubborn dirt from painted parts before washing the motorcycle.

To prevent stains, do not wash the vehicle immediately after it has been exposed to bright sunlight and do not wash it in the sun.

Regularly clean the fork tubes of contamination.

Make sure that the vehicle is washed more frequently, especially during the winter months and when riding on streets in coastal areas.

To remove salt deposits, clean the vehicle and any add-on parts with cold water immediately after completion of every trip.



After rides in the rain, in high humidity and after the vehicle is washed, condensation can form inside the headlight. During this process, the headlight can become foggy for a while. If moisture accumulates in the headlight on an ongoing basis, contact a specialist workshop, preferably

an authorized BMW Motorrad retailer.



WARNING

Damp brake disks and brake pads after washing the motorcycle, after riding through water or in the rain

Poorer braking action, accident hazard

- Brake early until the brake rotors and brake pads are dry.



ATTENTION

Increased effect of salt caused by warm water

Corrosion

- Only use cold water to remove salt deposits.



ATTENTION

Damage caused by high water pressure from high-pressure cleaners or steam-jet devices

Corrosion or short circuit, damage to labels, to seals, to hydraulic brake system, to the electrical system and the seat

- Exercise caution when using high-pressure or steam-jet devices.

CLEANING SENSITIVE VEHICLE PARTS

Plastics



ATTENTION

Use of unsuitable cleaning agents

Damage to plastic surfaces

- Do not use abrasive cleaners or cleaners containing alcohol or solvents.
- Do not use insect sponges or sponges with a hard surface.

Clean plastic components with water and BMW plastic care emulsion. This includes in particular:

178 CARE

- Windshields and wind deflectors
- Headlight diffusers made of plastic
- Glass cover of the instrument cluster
- Black, unpainted parts

 Soften stubborn dirt and dead insects by covering the affected areas with a wet cloth.

 Clean with water and sponge only.

 Do not use chemical cleaning agents.

TFT display

Clean the TFT display with warm water and detergent. Then dry with a clean cloth, e.g. a paper towel.

Chrome

Carefully clean chrome parts with plenty of water and motorcycle cleaner of the BMW Motorrad Care Products series. This is particularly important in case of exposure to salt.

Use BMW Motorrad metal polish for additional treatment.

Radiator

Clean the radiator regularly to prevent overheating of the electrical machine due to inadequate cooling.

For example, use a garden hose with low water pressure.

ATTENTION

Bending of radiator fins

Damage to radiator fins

- When cleaning, ensure that the cooler fins are not bent.

Rubber

Treat rubber parts with water or BMW rubber care product.

ATTENTION

Use of silicone sprays for care of rubber seals

Damage to rubber seals

- Do not use silicone sprays or care products that contain silicone.

CARE OF PAINTWORK

Washing the motorcycle regularly will help counteract the long-term effects of substances that damage the paint, especially if your motorcycle is ridden in areas with high air pol-

lution or natural sources of dirt, such as tree resin or pollen. However, remove particularly aggressive substances immediately; otherwise changes in the paint or discoloration may occur. These include spilled fuel, oil, grease and brake fluid as well as bird droppings. It is recommended to use BMW Motorrad solvent cleaner and then apply BMW Motorrad high-gloss polish to preserve the paint.

Contaminants on the paint surface are particularly easy to see after washing the vehicle. Remove this type of dirt immediately with cleaning benzene or ethyl alcohol on a clean cloth or cotton ball. BMW Motorrad recommends removing tar stains with BMW tar remover. Then add a protective wax coating to the paint at these locations.

PAINT PRESERVATION

Apply a preservative when water fails to bead up on the painted surface.

BMW Motorrad recommends BMW Motorrad high gloss polish or agents that contain carnauba or synthetic wax for paint preservation.



Chrome lacquer must not be preserved with chrome polish.

Only use the agents recommended by BMW Motorrad.



ATTENTION

Paint damage from metal polish

Risk of damage

- Do not treat paints and chrome lacquers with metal polish.

TECHNICAL DATA

13

TROUBLESHOOTING CHART	184
CHARGING	187
DRIVETRAIN	188
TRANSMISSION	188
REAR-WHEEL DRIVE	188
FRAME	188
RUNNING GEAR	189
BRAKES	189
WHEELS AND TIRES	190
ELECTRICAL SYSTEM	191
ANTI-THEFT ALARM SYSTEM	192
DIMENSIONS	192
WEIGHTS	193
PERFORMANCE DATA	193

184 TECHNICAL DATA

TROUBLESHOOTING CHART

Ride readiness cannot be turned on:

Possible cause	Remedy
Side stand folded out	Fold in side stand.
Start without applying brake	Start with one brake lever applied.
12 V battery dead	Charge 12 V battery. ( 159)

Bluetooth connection is not established.

Possible cause	Remedy
Necessary pairing steps were not performed.	Refer to the operating instructions of the communication system for the necessary steps for pairing.
The communication system is not connected automatically despite successful pairing.	Switch off the communication system of the helmet and connect again after one to two minutes.
Too many Bluetooth® devices are stored in the helmet.	Delete all pairing entries in the helmet (see the operating instructions of the communication system).
There are additional vehicles with Bluetooth-capable devices nearby.	Avoid simultaneous pairing with multiple vehicles.

Bluetooth connection is disrupted.

Possible cause	Remedy
Bluetooth connection to the mobile end device is interrupted.	Switch off energy saving mode.
Bluetooth connection to the helmet is interrupted.	Switch off the communication system of the helmet and connect again after one to two minutes.
Volume in the helmet cannot be adjusted.	Switch off the communication system of the helmet and connect again after one to two minutes.

Phone book is not displayed in the TFT display.

Possible cause	Remedy
Phone book was has not yet been transferred to the vehicle.	When pairing to the mobile end device, confirm the transfer of the telephone data (▣➔ 96).

Active route guidance is not displayed in the TFT display.

Possible cause	Remedy
Navigation from the BMW Motorrad Connected App was not transferred.	Call up the BMW Motorrad Connected App on the connected mobile end device before riding.
Route guidance cannot be started.	Ensure that there is a data connection to the mobile end device and check the map data on the mobile end device.

186 TECHNICAL DATA



The playlist is not displayed in the TFT display.

Possible cause	Remedy
There are too many tracks in the playback list on the mobile end device.	Reduce the number of tracks in the playback list on the mobile end device.

CHARGING

Total capacity of the high-voltage battery	60.6 Ah
Net energy content of high-voltage energy storage system	8.5 kWh
Note on charging time	The information on the charging time assumes that the nominal charge current is used for the charging operation. Temperatures and the selected charging infrastructure, charging cables and charging current limit can extend the charging time.

Charging time

Charging time of the high-voltage battery with standard charging cable	 210 min, 80% charge for charge current: 10 A 260 min, 100% charge for charge current: 10 A
Charging time of the high-voltage battery with Mode3 charging cable	
-with quick charger ^{OE}	 65 min, 80% charge for charge current: 30 A 100 min, 100% charge for charge current: 30 A

188 TECHNICAL DATA

DRIVETRAIN

Engine number location	Bottom of engine housing
Engine type	IA0P06A
Engine design	Synchronous machine
~with quick charger ^{OE}	Synchronous machine (3-phase, permanently excited)
Rated continuous power	20 hp (15 kW)
Maximum power	42 hp (31 kW), at RPM: 4900 min ⁻¹
Torque	46 lb/ft (62 Nm), at RPM: 1500 min ⁻¹
Maximum engine speed	max 12300 min ⁻¹

TRANSMISSION

Transmission design	1-speed manual transmission integrated in engine housing
---------------------	---

REAR-WHEEL DRIVE

Type of final drive	Toothed belt drive
Type of rear-wheel guide	Single arm aluminum alloy casting swingarm with rear wheel axle adjustable eccentric cam

FRAME

Frame design	Steel-double cradle frame
Location of type plate	Frame at front right on steering head
Location of the vehicle identification number	Main frame at lower front right

RUNNING GEAR

Front wheel

Type of front suspension	Telescopic forks
Spring travel, front	4.3 in (110 mm), on front wheel

Rear wheel

Design of rear-wheel suspension	Directly linked spring strut with adjustable spring preload
Spring travel on the rear wheel	3.6 in (92 mm), on rear wheel

BRAKES**Front wheel**

Type of front wheel brake	Two-rotor disk brake, rigid, diameter 265 mm, 4-piston fixed caliper
Front brake pad material	Organic
Front brake disc thickness	0.2 in (5 mm), New min 0.18 in (min 4.5 mm), Wear limit
Free travel of brake actuation (Front wheel brake)	0.03...0.13 in (0.7...3.4 mm), at piston

Rear wheel

Type of rear wheel brake	Single-disc brake, diameter 265 mm, 1-piston floating caliper
Rear brake pad material	Organic
Rear brake disc thickness	0.2 in (5 mm), New min 0.18 in (min 4.5 mm), Wear limit

190 TECHNICAL DATA

WHEELS AND TIRES

Recommended tire combinations	An overview of the current tire approvals is available from your authorized BMW Motorrad retailer.
Speed category of front/rear tires	H, minimum requirement: 130 mph (210 km/h)

Front wheel

Front wheel design	Aluminum cast wheel
Front-wheel rim size	3.50" x 15"
Front tire designation	120/70 R 15
Load index for front tire	56
Permitted front wheel imbalance	max 0.2 oz (max 5 g)

Rear wheel

Rear wheel design	Aluminum cast wheel
Rear-wheel rim size	4.50" x 15"
Rear tire designation	160/60 R 15
Load index for rear tire	67
Permitted rear wheel imbalance	max 0.2 oz (max 5 g)

Tire pressures

Front tire pressure	33.4 psi (2.3 bar), One-up mode, with cold tires 33.4 psi (2.3 bar), Two-up mode with load, with cold tires
Rear tire pressure	36.3 psi (2.5 bar), One-up mode, with cold tires 36.3 psi (2.5 bar), Two-up mode with load, with cold tires

ELECTRICAL SYSTEM

Electrical rating of onboard sockets	max 5 A, all on-board power sockets in total
Main fuse	40 A, Main fuse
Fuse 1	15 A, EME, relay terminal 30 switched
Fuse 2	7.5 A, Terminal 30B, drive electronics, Antilock Braking System (ABS), sensor box, seat heating, USB charging compartment, TPM, storage compartments
Fuse 3	10 A, EME
Fuse 4	7.5 A, Terminal 30, cut-off relay terminal 30B, anti-theft alarm system, vehicle lock, instrument cluster, on-board charger, diagnostic connector
Fuse 5	7.5 A, Terminal 30C, multi-function switch left, high-voltage safety plug, EME, on-board charger
Fuse 6	Not in use
Fuse 7	Not in use
Fuse 8	Not in use

Battery

Battery design	AGM (Absorbent Glass Mat) battery, maintenance-free
Battery voltage	12 V
Battery capacity	5 Ah

Light sources

All light sources	LED
-------------------	-----

192 TECHNICAL DATA

ANTI-THEFT ALARM SYSTEM

—with anti-theft alarm system (DWA)^{OE}

Activation time	Approx. 30 s
Alarm duration	Approx. 26 s
Battery type	CR 123 A

DIMENSIONS

Motorcycle length	90 in (2285 mm), over license-plate carrier
Motorcycle height	45.3 in (1150 mm), over windshield, at DIN unloaded vehicle weight
—with windshield, high ^{OE}	51.8 in (1315 mm), over windshield, at DIN unloaded vehicle weight
Motorcycle width	33.7 in (855 mm), with mirrors 32.3 in (820 mm), over handlebar weights
Front-seat height	30.7 in (780 mm), without rider, at DIN unloaded vehicle weight
—with backrest comfort seat ^{OE}	31.5 in (800 mm), without rider, at DIN unloaded vehicle weight
Rider's inside-leg arc, heel to heel	71.3 in (1810 mm), without rider, at DIN unloaded vehicle weight
—with backrest comfort seat ^{OE}	73.1 in (1856 mm), without rider, at DIN unloaded vehicle weight

WEIGHTS

Unloaded vehicle weight	516 lbs (234 kg), DIN unladen weight without OE
Front wheel load at unloaded vehicle weight	262 lbs (119 kg)
Gross vehicle weight	904 lbs (410 kg)
Rear wheel load at unloaded vehicle weight	247 lbs (112 kg)
Maximum payload	388 lbs (176 kg)
Payload of Topcase	
–with topcase ^{OA}	max 11 lbs (max 5 kg)
Payload of the helmet compartment	max 18 lbs (max 8 kg)
Payload of soft bag	max 11 lbs (max 5 kg)

PERFORMANCE DATA

Maximum speed	75 mph (120 km/h)
Cruising range	81 miles (130 km), in accordance with WMTC

SERVICE

14

REPORTING SAFETY DEFECTS	196
RECYCLING	197
BMW MOTORRAD SERVICE	197
BMW MOTORRAD SERVICE HISTORY	198
BMW MOTORRAD MOBILITY SERVICES	198
MAINTENANCE WORK	198
MAINTENANCE SCHEDULE	200
BMW MOTORRAD BREAK-IN SERVICE	201
MAINTENANCE CONFIRMATIONS	202
SERVICE CONFIRMATIONS	214

REPORTING SAFETY DEFECTS

If you think that your motorcycle has a fault which may cause an accident, injury or death, you must inform the NHTSA (National Highway Traffic Safety Administration) immediately and BMW of North America, LLC.

If the NHTSA receives other similar complaints, it may open an investigation. If it finds that a safety defect exists in a group of vehicles, the NHTSA may order the manufacturer to perform a recall and remedy campaign. However, the NHTSA cannot become involved in individual problems between you, your authorized BMW Motorrad retailer, or BMW of North America, LLC. You can contact the NHTSA by calling the Vehicle Safety Hotline on 1-888-327-4236 (Teletypewriter TTY for the hearing impaired: 1-800-424-9153) for free, by visiting the website at [http:// www.safercar.gov](http://www.safercar.gov) or by writing to Administrator, NHTSA, 400 Seventh Street, SW., Washington, DC 20590. Further information on vehicle safety is available at [http:// www.safercar.gov](http://www.safercar.gov). Canadian customers who wish to report a safetyrelated defect to Transport Canada, Defect Investigations and Recalls, may call the toll-free hotline 1-800-333-0510. You can also obtain other information about motor vehicle safety from [http:// www.tc.gc.ca/roadsafety](http://www.tc.gc.ca/roadsafety).

RECYCLING

Disposal of a vehicle

When the vehicle has reached the end of its life cycle, BMW Motorrad recommends giving it to a collection point designated by the manufacturer.

The respective national legal requirements apply to this collection and recycling in general. Information about recycling and sustainability can be retrieved at the country-specific websites of the manufacturer. More information can be requested from your authorized BMW Motorrad retailer or another qualified service partner or a specialist workshop.

BMW MOTORRAD SERVICE

With its worldwide retailer network, BMW Motorrad can attend to you and your electric scooter in over 100 countries around the globe. Authorized BMW Motorrad retailers have the technical information and expertise needed to reliably conduct all preventive maintenance and repair procedures on your BMW.

You will find the nearest authorized BMW Motorrad

retailer at our website:
bmw-motorrad.com.



WARNING

Improperly performed maintenance and repair work

Risk of accident as a result of damage

- BMW Motorrad recommends having corresponding work on your E-Scooter carried out by a specialized workshop, preferably by an authorized retailer BMW Motorrad partner.

To ensure that your BMW is always in optimum condition, BMW Motorrad recommends that you comply with the maintenance intervals specified for your electric scooter.

Have all maintenance and repair work carried out confirmed in the "Service" chapter in this manual. Documented proof of scheduled preventive maintenance is essential for generous treatment of claims submitted after the warranty period has expired (goodwill).

198 SERVICE

You can obtain information on the contents of the BMW Motorrad Services from your BMW Motorrad retailer.

BMW MOTORRAD SERVICE HISTORY

Entries

Maintenance work that has been performed is recorded in the diagnostics and information system. Like a Service Booklet, these entries provide proof of regular maintenance.

If an entry is made in the vehicle's electronic Service History (eSH), service-related data is stored on the central IT systems of BMW AG in Munich, Germany.

When there is a change in vehicle owner, the data entered in the electronic Service History can also be viewed by the new vehicle owner. A BMW Motorrad retailer or specialist workshop can view the data entered in the electronic Service History.

Objection

At the BMW Motorrad retailer or specialist workshop, the vehicle owner can object to the entry of data in the electronic Service History with the related

storage of data in the vehicle and the transfer of data to the vehicle manufacturer during his time as the vehicle owner. In this case, no entry is made in the vehicle's electronic Service History.

BMW MOTORRAD MOBILITY SERVICES

The BMW Motorrad mobility services provide you and your new BMW electric scooter with extra security by offering a wide array of assistance services in the event of a breakdown (mobile service, breakdown assistance, vehicle recovery and retrieval, etc.).

Contact your authorized BMW Motorrad retailer for additional information on available mobility services.

MAINTENANCE WORK

BMW pre-delivery check

The BMW pre-delivery check is carried out by your authorized BMW Motorrad retailer before it turns the motorcycle over to you.

BMW Running-in check

The BMW running-in check must be carried out between 300 mi (500 km) and 750 mi (1200 km).

BMW Motorrad Service

The BMW Motorrad service is carried out every 24 months or every 6000 miles (10000 km) (whichever comes first). The scope of services can vary, depending on the age of the vehicle and the distance covered. Your BMW Motorrad retailer confirms that the service has been performed and enters the date for the next service.

For riders with high annual mileage, it may be necessary to come in for service before the entered date. In these cases, a corresponding maximum distance covered will also be entered in the confirmation of service. If this distance covered is reached before the next service appointment, service must be performed sooner.

More information on the topic of service is available at:

bmw-motorrad.com/service

The required scope of maintenance work for your vehicle can be found in the following maintenance schedule:

200 SERVICE

MAINTENANCE SCHEDULE

	500 -1200 km 300 - 750 mls	10 000 km 6 000 mls	20 000 km 12 000 mls	30 000 km 18 000 mls	40 000 km 24 000 mls	50 000 km 30 000 mls	60 000 km 36 000 mls	70 000 km 42 000 mls	80 000 km 48 000 mls	90 000 km 54 000 mls	100 000 km 60 000 mls	12 months	24 months
1	X												
2		X	X	X	X	X	X	X	X	X	X		X ^a
3					X				X				
4													X
5	X				X				X				

- 1 BMW Motorrad break-in service
 - 2 Standard scope of BMW Motorrad service
 - 3 Replace belt
 - 4 Change brake fluid in the entire system
 - 5 Change transmission oil
- ^a every two years or every 6000 miles (whichever comes first)

BMW MOTORRAD BREAK-IN SERVICE

BMW Motorrad break-in service

The BMW Motorrad break-in service repair procedures are listed below. The actual scope of maintenance required for your vehicle may differ.

- Setting the service date and remaining distance
- Performing the vehicle test using the BMW diagnostic system
- Checking the front/rear brake fluid level
- Lubricating the side stand and checking the Bowden cable for parking brake
- Lubricating the bearing of the Bowden cable for the parking brake and checking the basic setting and holding effect of the parking brake
- Removing the outer belt guard
- Change transmission oil
- Checking the belt tension
- Installing the outer belt guard
- Checking the coolant composition
- Checking the tire pressure and tread depth
- Checking steering-head bearing
- Checking the lighting and signal system
- Start enable functional check
- Final inspection and road safety check
- Performing the vehicle test using the BMW diagnostic system
- Confirming the BMW service in the vehicle literature

MAINTENANCE CONFIRMATIONS

BMW Motorrad Service standard scope

The repair procedures belonging to the BMW Motorrad Service standard package are listed below. The actual maintenance work applicable for your vehicle may differ.

- Checking charging state of battery
- Visual inspection of the brake lines, brake hoses and connections
- Change brake fluid in the entire system
- Checking the front/rear brake fluid level
- Checking the front brake pads and brake discs for wear
- Checking the rear brake pads and brake disc for wear
- Lubricating the side stand and checking the Bowden cable for parking brake
- Lubricating the bearing of the Bowden cable for the parking brake and checking the basic setting and holding effect of the parking brake
- Replace belt
- Change transmission oil
- Checking steering-head bearing
- Checking the coolant composition
- Checking the tire pressure and tread depth
- Checking the lighting and signal system
- Start enable functional check
- Final inspection and road safety check
- Performing the vehicle test using the BMW Motorrad diagnostic system
- Performing the vehicle test using the BMW diagnostic system
- Set the service date and remaining distance using the BMW Motorrad diagnostic system
- Confirming the BMW Motorrad service in the vehicle literature

BMW Motorrad pre-delivery check

performed

on _____

Stamp, signature

BMW Motorrad break-in service

performed

on _____

at km _____

Next service

latest

on _____

or, if reached earlier

at km _____

Stamp, signature

204 SERVICE

BMW Motorrad Service

performed

on _____

at km _____

Next service

latest

on _____

or, if reached earlier

at km _____

Work performed

BMW Motorrad Service

Yes No

Replacing belt

Changing brake fluid in entire system

Changing gear oil

Notes

Stamp, signature

BMW Motorrad Service

performed

on _____

at km _____

Next service

latest

on _____

or, if reached earlier

at km _____

Work performed

	Yes	No
BMW Motorrad Service	<input type="checkbox"/>	<input type="checkbox"/>
Replacing belt	<input type="checkbox"/>	<input type="checkbox"/>
Changing brake fluid in entire system	<input type="checkbox"/>	<input type="checkbox"/>
Changing gear oil	<input type="checkbox"/>	<input type="checkbox"/>

Notes

Stamp, signature

206 SERVICE

BMW Motorrad Service

performed

on _____

at km _____

Next service

latest

on _____

or, if reached earlier

at km _____

Work performed

BMW Motorrad Service

Yes No

Replacing belt

Changing brake fluid in entire system

Changing gear oil

Notes

Stamp, signature

BMW Motorrad Service

performed

on _____

at km _____

Next service

latest

on _____

or, if reached earlier

at km _____

Work performed

	Yes	No
BMW Motorrad Service	<input type="checkbox"/>	<input type="checkbox"/>
Replacing belt	<input type="checkbox"/>	<input type="checkbox"/>
Changing brake fluid in entire system	<input type="checkbox"/>	<input type="checkbox"/>
Changing gear oil	<input type="checkbox"/>	<input type="checkbox"/>

Notes

Stamp, signature

208 SERVICE

BMW Motorrad Service

performed

on _____

at km _____

Next service

latest

on _____

or, if reached earlier

at km _____

Work performed

BMW Motorrad Service

Yes No

Replacing belt

Changing brake fluid in entire system

Changing gear oil

Notes

Stamp, signature

BMW Motorrad Service

performed

on _____

at km _____

Next service

latest

on _____

or, if reached earlier

at km _____

Work performed

	Yes	No
BMW Motorrad Service	<input type="checkbox"/>	<input type="checkbox"/>
Replacing belt	<input type="checkbox"/>	<input type="checkbox"/>
Changing brake fluid in entire system	<input type="checkbox"/>	<input type="checkbox"/>
Changing gear oil	<input type="checkbox"/>	<input type="checkbox"/>

Notes

Stamp, signature

210 SERVICE

BMW Motorrad Service

performed

on _____

at km _____

Next service

latest

on _____

or, if reached earlier

at km _____

Work performed

BMW Motorrad Service

Yes No

Replacing belt

Changing brake fluid in entire system

Changing gear oil

Notes

Stamp, signature

BMW Motorrad Service

performed

on _____

at km _____

Next service

latest

on _____

or, if reached earlier

at km _____

Work performed

	Yes	No
BMW Motorrad Service	<input type="checkbox"/>	<input type="checkbox"/>
Replacing belt	<input type="checkbox"/>	<input type="checkbox"/>
Changing brake fluid in entire system	<input type="checkbox"/>	<input type="checkbox"/>
Changing gear oil	<input type="checkbox"/>	<input type="checkbox"/>

Notes

Stamp, signature

212 SERVICE

BMW Motorrad Service

performed

on _____

at km _____

Next service

latest

on _____

or, if reached earlier

at km _____

Work performed

BMW Motorrad Service

Yes No

Replacing belt

Changing brake fluid in entire system

Changing gear oil

Notes

Stamp, signature

BMW Motorrad Service

performed

on _____

at km _____

Next service

latest

on _____

or, if reached earlier

at km _____

Work performed

	Yes	No
BMW Motorrad Service	<input type="checkbox"/>	<input type="checkbox"/>
Replacing belt	<input type="checkbox"/>	<input type="checkbox"/>
Changing brake fluid in entire system	<input type="checkbox"/>	<input type="checkbox"/>
Changing gear oil	<input type="checkbox"/>	<input type="checkbox"/>

Notes

Stamp, signature

CERTIFICATE FOR ELECTRONIC IMMOBILIZER	217
CERTIFICATE FOR KEYLESS RIDE	220
CERTIFICATE FOR KEYLESS RIDE	222
CERTIFICATE FOR KEYLESS RIDE	224
CERTIFICATE FOR KEYLESS RIDE	226
CERTIFICATE FOR TIRE PRESSURE MONITOR	228
CERTIFICATE FOR TFT INSTRUMENT CLUSTER	229

Declaration of Conformity

Radio equipment electronic immobiliser (EWS4)

For all countries without EU

Technical information

Frequency Band: 134 kHz
(Transponder: TMS37145 /
Type DST80, TMS3705
Transponder Base Station IC)
Output Power: 50 dB μ V/m

Manufacturer and Address

Manufacturer:
BECOM Electronics GmbH
Address: Technikerstraße 1,
A-7442 Hochstraß

Argentina

 **RAMATEL**

H-25246

Australia/New Zealand



R-NZ

Brunei



TA No: DTA-007061

United Arab Emirates

TRA
REGISTERED No:
ER89926/20

DEALER No:
DA96133I20

Philippiens



NTC

Type Approved
No.: ESD-RCE-2023298

South Africa



TA-2020/6131

APPROVED

India

ETA-SD-20200905860

Belarus



Indonesia

72790/SDPPI/2021
13349



Dilarang melakukan perubahan
Spesifikasi yang dapat
Menimbulkan gangguan fisik
dan/atau elektromagnetik
terhadap lingkungan sekitarnya

Paraguay

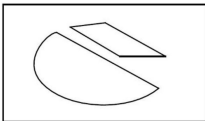

CONATEL

NR: 2020-11-I-0834

Singapore

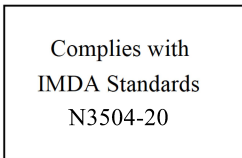

Taiwan



低功 電波 射性電機管 辦法
第十二條 經型式認證合格之低
功率射頻電機，非經許可，公
司、商號或使用者均不得擅 自變
更頻率、加大功率或變更原設計
之特性及 功能。第十四條 低功
率射頻電機之使用不 得影響飛航
安全及干擾合法通信；經發現有
干 擾現象時，應立即停用，並改
善至無干擾時方 得繼續使用。前
項合法通信，指依電信法規定作
業之無線電 通信。

Malaysia



RFCL/47A/0920/S(20-3358)

Israel

מספר אישור אלחוטני של משרד התקשורת הוא
51-74908
אסור להחליף את האנטנה המקורית של המכשיר
ולא
לעשות בו כל שינוי טכני אחר

United States (USA)

Contains FCC ID:

ODE-MREWS5012

FCC § 15.19 Labelling requirements

This device complies with part 15 of the FCC Rules and Industry Canada's licence-exempt RSS standard(s). Operation is subject to the following two conditions:

- (1) this device may not cause interference, and
- (2) this device must accept any interference received, including interference that may cause undesired operation.

FCC § 15.21 Information to user

Changes or modifications not expressly approved by the party responsible for compliance could void the user's authority to operate the equipment.

RF Exposure Requirements

To comply with FCC RF exposure compliance requirements, the device must be installed to provide a separation distance of at least 20 cm from all persons.

Serbia



P1620118300

Canada

Contains IC:

10430A-MREWS5012

This device complies with part 15 of the FCC Rules and Industry Canada license-exempt RSS standard(s). Operation is subject to the following two conditions:

- (1) this device may not cause interference, and
- (2) this device must accept any interference received, including interference that may cause undesired operation.

Le présent appareil est conforme aux CNR d'Industrie Canada applicables aux appareils radio exempts de licence. L'exploitation est autorisée aux deux conditions suivantes : (1) l'appareil ne doit pas produire de brouillage, et (2) l'utilisateur de l'appareil doit accepter tout brouillage radioélectrique subi, même si le brouillage est susceptible d'en compromettre le fonctionnement.

Vietnam

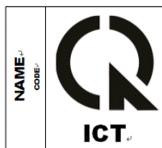

A1109091120AF04A3

Declaration of Conformity

Keyless Ride ECU

For all Countries without EU

Model name: HUF8485

Technical information

Frequenzy band: 134,45 kHz
Output/Transmission Power:
42 dB μ V/m

Manufacturer and Address

Huf Hüsbeck &
Fürst GmbH & Co. KG
Steger Str. 17,
42551 Velbert, Germany

Argentina

R RAMATEL

H-27411

Morocco

AGREE PAR L'ANRT MAROC
Numéro d'agrément: MR00031290ANRT2022
Date d'agrément: 06/01/2022

Nigeria

Connection and use of this communications
equipment is permitted by the Nigerian
Communications Commission

United Arab Emirates



TRA - United Arab Emirates

Dealer ID: DA36976/14
TA RTTE: ER04912/22
Model: HUF8485
Type: BMW



Malaysia

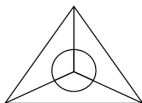

MCMC
HIDF17000037

Philippines



NTC

Type Approved
No. ESD-RCE-2228692

South Africa



TA-2022/0251

APPROVED

Vietnam



Indonesia

81597/SDPPI/2022



13349

Paraguay

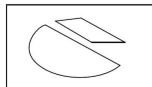

CONATEL

2022-01-I-0052

Pakistan



Oman

OMAN - TRA

R/13020/22

D100428

Singapore

Complies with
IMDA Standards
DA105282

Canada

This device complies with part 15 of the FCC Rules and Industry Canada licence-exempt RSS standard(s). Operation is subject to the following two conditions:

- (1) This device may not cause interference.
- (2) This device must accept any interference, including interference that may cause undesired operation of the device.

Le présent appareil est conforme aux CNR d'Industrie Canada applicables aux appareils radio exempts de licence. L'exploitation est autorisée aux deux conditions suivantes :

- (1) L'appareil ne doit pas produire de brouillage;
- (2) L'utilisateur de l'appareil doit accepter tout brouillage radioélectrique subi, même si le brouillage est susceptible d'en compromettre le fonctionnement.

United States (USA)

This device complies with part 15 of the FCC Rules. Operation is subject to the following two conditions:

- (1) This device may not cause harmful interference.
- (2) This device must accept any interference received, including interference that may cause undesired operation.

CAUTION:

Changes or modifications not expressly approved by the party responsible for compliance could void the user's authority to operate the equipment.

Taiwan

取得審驗證明之低功率射頻器材，非經核准，公司、商號或使用者均不得擅自變更頻率、加大功率或變更原設計之特性及功能。低功率射頻器材之使用

不得影響飛航安全及干擾合法通信；經發現有干擾現象時，應立即停用，並改善至無干擾時方得繼續使用。前述合法通信，指依電信管理法規定作業之

無線電通信。低功率射頻器材須忍受合法通信或工業、科學及醫療用電波輻射性電機設備之干擾

Thailand



nabp.

เครื่องวิทยุคมนาคมนี้ ได้รับยกเว้น ไม่ต้องได้รับใบอนุญาตให้มี ใช้ซึ่งเครื่องวิทยุคมนาคมหรือตั้งสถานีวิทยุคมนาคมตามประกาศ กสทช. เรื่อง เครื่องวิทยุคมนาคม และสถานีวิทยุคมนาคมที่ได้รับยกเว้นไม่ต้องได้รับใบอนุญาตวิทยุคมนาคมตามพระราชบัญญัติวิทยุคมนาคม พ.ศ. 2498



nabp. | โทรคมนาคม

กำกับดูแลเพื่อประชาชน

Call Center 1200 (InswS)

Declaration of Conformity

Keyless Ride Key

For all Countries without EU

Model name: HUF5794

Technical information

Frequenzy band: 433,92 MHz

Output/Transmission Power:

10 mW

Manufacturer and Address

Huf Hülsbeck &

Fürst GmbH & Co. KG

Steeger Str. 17,

42551 Velbert, Germany

Oman

OMAN - TRA
R/13021/22
D100428

Morocco

AGREE PAR L'ANRT MAROC
Numéro d'agrément: MR00031289ANRT2022
Date d'agrément: 06/01/2022

Nigeria

Connection and use of this communications equipment is permitted by the Nigerian Communications Commission
--

United Arab Emirates



TRA - United Arab Emirates
Dealer ID: DA36976/14
TA RTTE: ER04909/22
Model: HUF5794
Type: BMW



Malaysia



Philippines



South Africa



Vietnam



Indonesia



Paraguay



Pakistan



Belarus



Serbia



Singapore

Complies with IMDA Standards DA105282

Canada

This device complies with part 15 of the FCC Rules and Industry Canada licence-exempt RSS standard(s). Operation is subject to the following two conditions:

- (1) This device may not cause interference.
- (2) This device must accept any interference, including interference that may cause undesired operation of the device.

Le présent appareil est conforme aux CNR d'Industrie Canada applicables aux appareils radio exempts de licence. L'exploitation est autorisée aux deux conditions suivantes :

- (1) L'appareil ne doit pas produire de brouillage;
- (2) L'utilisateur de l'appareil doit accepter tout brouillage radioélectrique subi, même si le brouillage est susceptible d'en compromettre le fonctionnement.

United States (USA)

This device complies with part 15 of the FCC Rules. Operation is subject to the following two conditions:

- (1) This device may not cause harmful interference.
- (2) This device must accept any interference received, including interference that may cause undesired operation.

CAUTION:

Changes or modifications not expressly approved by the party responsible for compliance could void the user's authority to operate the equipment.

Taiwan

取得審驗證明之低功率射頻器材，非經核准，公司、商號或使用者均不得擅自變更頻率、加大功率或變更原設計之特性及功能。低功率射頻器材之使用

不得影響飛航安全及干擾合法通信；經發現有干擾現象時，應立即停用，並改善至無干擾時方得繼續使用。前述合法通信，指依電信管理法規定作業之

無線電通信。低功率射頻器材須忍受合法通信或工業、科學及醫療用電波輻射性電機設備之干擾

Thailand



nabp.

เครื่องวิทยุคมนาคมนี้ ได้รับยกเว้น ไม่ต้องได้รับใบอนุญาตให้มี ใช้ซึ่งเครื่องวิทยุคมนาคมหรือตั้งสถานีวิทยุคมนาคมตามประกาศ กสทช. เรื่อง เครื่องวิทยุคมนาคม และสถานีวิทยุคมนาคมที่ได้รับยกเว้นไม่ต้องได้รับใบอนุญาตวิทยุคมนาคมตามพระราชบัญญัติวิทยุคมนาคม พ.ศ. 2498



nabp. | โทรคมนาคม
กำกับดูแลเพื่อประชาชน
Call Center 1200 (InswS)

Declaration of Conformity

Keyless Ride ECU

For all Countries without EU

Model name: HUF8465

Technical information

Frequenzy band: 134,45 kHz

Output/Transmission Power:
42 dB μ V/m

Manufacturer and Address

Huf H \ddot{u} lsbeck &
F \ddot{u} rst GmbH & Co. KG
Steeger Str. 17,
42551 Velbert, Germany

Argentina

RAMATEL

H-27885

Morocco

AGREE PAR L'ANRT MAROC

Numéro d'agrément: MR 9389 ANRT 2014

Date d'agrément: 24/06/2014

Nigeria

Connection and use of this communications
equipment is permitted by the Nigerian
Communications Commission

United Arab Emirates



TRA – United Arab Emirates

Dealer ID: DA36976/14
TA RTTE: ER59309/17
Model: HUF8465
Type: ELV incl. ECU



Malaysia

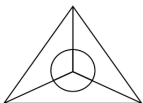

MCMC
HIDF17000037

Philippines



NTC

Type Approved

No. ESD-1409281C

South Africa



TA-2014/886

APPROVED

Vietnam



Indonesia

81555/SDPPI/2022

13349



Paraguay

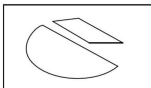

CONATEL

2020-05-I-0278

Singapore

Complies with
IMDA Standards
DA101586

Canada

This device complies with part 15 of the FCC Rules and Industry Canada licence-exempt RSS standard(s). Operation is subject to the following two conditions:

- (1) This device may not cause interference.
- (2) This device must accept any interference, including interference that may cause undesired operation of the device.

Le présent appareil est conforme aux CNR d'Industrie Canada applicables aux appareils radio exempts de licence. L'exploitation est autorisée aux deux conditions suivantes :

- (1) L'appareil ne doit pas produire de brouillage;
- (2) L'utilisateur de l'appareil doit accepter tout brouillage radioélectrique subi, même si le brouillage est susceptible d'en compromettre le fonctionnement.

United States (USA)

This device complies with part 15 of the FCC Rules. Operation is subject to the following two conditions:

- (1) This device may not cause harmful interference.
- (2) This device must accept any interference received, including interference that may cause undesired operation.

CAUTION:

Changes or modifications not expressly approved by the party responsible for compliance could void the user's authority to operate the equipment.

Taiwan

取得審驗證明之低功率射頻器材，非經核准，公司、商號或使用者均不得擅自變更頻率、加大功率或變更原設計之特性及功能。低功率射頻器材之使用

不得影響飛航安全及干擾合法通信；經發現有干擾現象時，應立即停用，並改善至無干擾時方得繼續使用。前述合法通信，指依電信管理法規定作業之

無線電通信。低功率射頻器材須忍受合法通信或工業、科學及醫療用電波輻射性電機設備之干擾

Thailand



nabp.

เครื่องวิทยุคมนาคมนี้ ได้รับยกเว้น ไม่ต้องได้รับใบอนุญาตให้มี ใช้ซึ่งเครื่องวิทยุคมนาคมหรือตั้งสถานีวิทยุคมนาคมตามประกาศ กสทช. เรื่อง เครื่องวิทยุคมนาคม และสถานีวิทยุคมนาคมที่ได้รับยกเว้นไม่ต้องได้รับใบอนุญาตวิทยุคมนาคมตามพระราชบัญญัติวิทยุคมนาคม พ.ศ. 2498



nabp. | โทรคมนาคม

กำกับดูแลเพื่อประชาชน
Call Center 1200 (Inswr)

Declaration of Conformity

Keyless Ride Key

For all Countries without EU

Model name: HUF5750

Technical information

Frequenzy band: 434,42 MHz

Output/Transmission Power:
10 mW

Manufacturer and Address

Huf Hülsbeck &
Fürst GmbH & Co. KG
Steeger Str. 17,
42551 Velbert, Germany

Argentina

CNC COMISIÓN NACIONAL
DE COMUNICACIONES
H-17115

Morocco

AGREE PAR L'ANRT MAROC
Numéro d'agrément: MR 8851 ANRT 2014
Date d'agrément: 17/01/2014

Nigeria

Connection and use of this communications
equipment is permitted by the Nigerian
Communications Commission

United Arab Emirates



TRA - United Arab Emirates

Dealer ID: DA36976/14
TA RTE: ER57698/17
Model: HUF5750
Type: RF transceiver for BMW Motorcycles



Malaysia



Paraguay



Philippines



Belarus



South Africa



Vietnam



Singapore

Complies with
IMDA Standards
DA101586

Indonesia



Serbia



Canada

This device complies with part 15 of the FCC Rules and Industry Canada licence-exempt RSS standard(s). Operation is subject to the following two conditions:

- (1) This device may not cause interference.
- (2) This device must accept any interference, including interference that may cause undesired operation of the device.

Le présent appareil est conforme aux CNR d'Industrie Canada applicables aux appareils radio exempts de licence. L'exploitation est autorisée aux deux conditions suivantes :

- (1) L'appareil ne doit pas produire de brouillage;
- (2) L'utilisateur de l'appareil doit accepter tout brouillage radioélectrique subi, même si le brouillage est susceptible d'en compromettre le fonctionnement.

United States (USA)

This device complies with part 15 of the FCC Rules. Operation is subject to the following two conditions:

- (1) This device may not cause harmful interference.
- (2) This device must accept any interference received, including interference that may cause undesired operation.

CAUTION:

Changes or modifications not expressly approved by the party responsible for compliance could void the user's authority to operate the equipment.

Taiwan

取得審驗證明之低功率射頻器材，非經核准，公司、商號或使用者均不得擅自變更頻率、加大功率或變更原設計之特性及功能。低功率射頻器材之使用

不得影響飛航安全及干擾合法通信；經發現有干擾現象時，應立即停用，並改善至無干擾時方得繼續使用。前述合法通信，指依電信管理法規定作業之

無線電通信。低功率射頻器材須忍受合法通信或工業、科學及醫療用電波輻射性電機設備之干擾

Thailand



nabp.

เครื่องวิทยุคมนาคมนี้ ได้รับยกเว้น ไม่ต้องได้รับใบอนุญาตให้มี ใช้ซึ่งเครื่องวิทยุคมนาคมหรือตั้งสถานีวิทยุคมนาคมตามประกาศ กสทช. เรื่อง เครื่องวิทยุคมนาคม และสถานีวิทยุคมนาคมที่ได้รับยกเว้นไม่ต้องได้รับใบอนุญาตวิทยุคมนาคมตามพระราชบัญญัติวิทยุคมนาคม พ.ศ. 2498



nabp. | โทรคมนาคม

กำกับดูแลเพื่อประชาชน
Call Center 1200 (Inswr)

Certification Tire Pressure Control (TPC)

FCC ID: MRXBC54MA4
IC: 2546A-BC54MA4

FCC ID: MRXBC5A4
IC: 2546A-BC5A4

This device complies with Part 15 of the FCC Rules and with Industry Canada license-exempt RSS standard(s).

Operation is subject to the following two conditions:

- (1) This device may not cause harmful interference, and
- (2) This device must accept any interference received, including interference that may cause undesired operation.

WARNING: Changes or modifications not expressly approved by the party responsible for compliance could void the user's authority to operate the equipment. The term "IC:" before the radio certification number only signifies that Industry Canada technical specifications were met.

Le présent appareil est conforme aux CNR d'Industrie Canada applicables aux appareils radio exempts de licence. L'exploitation est autorisée aux deux conditions suivantes:

- (1) l'appareil ne doit pas produire de brouillage, et
- (2) l'utilisateur de l'appareil doit accepter tout brouillage radioélectrique subi, même si le brouillage est susceptible d'en compromettre le fonctionnement.

WARNING: Changes or modifications not expressly approved by the party responsible for compliance could void the user's authority to operate the equipment. The term "IC:" before the radio certification number only signifies that Industry Canada technical specifications were met.

Declaration of Conformity

Radio equipment TFT instrument cluster

For all Countries without EU

Model name: ICC10in

Technical information

The ICC10in can operate in one of two operating modes:

1. Normal mode, with Bluetooth and WLAN on, and
2. Radio off mode (only available during vehicle manufacturing).

BT operating frq. Range:

2402 – 2480 MHz

BT version: 4.2 (no BTLE)

BT output power:

< +4 dBm (internal antenna)

WLAN operating frq. Range:

2402 – 2472 MHz

WLAN standards:

IEEE 802.11 b/g/n

WLAN output power:

< +14 dBm (internal antenna)

Manufacturer and Address

Manufacturer:

Robert Bosch GmbH

Address:

Robert-Bosch-Platz 1,
70839 Gerlingen, Germany

Turkey

Robert Bosch GmbH, ICC10in tipi telsiz sisteminin 2014/53/EU nolu yönetmeliğe uygun olduğunu beyan eder. AB Uygunluk Beyanı'nın tam metni, aşağıdaki internet adresinden görülebilir: <http://cert.bosch-carmultimedia.net>

Brazil

Este equipamento não tem direito de proteção contra interferência prejudicial e não pode causar interferência em sistemas devidamente autorizados. Para maiores informações, consulte o site da ANATEL www.anatel.gov.br

Thailand

เครื่องโทรคมนาคมและอุปกรณ์นี้ มีความสอดคล้องตามข้อกำหนดของ กทช.
(This telecommunication equipments is in compliance with NTC requirements)

Argentina

 **RAMATEL**

C-25636

Canada

This device contains licence-exempt transmitter(s)/ receiver(s) that comply with Innovation, Science and Economic Development Canada's licence-exempt RSS(s). Operation is subject to the following two conditions:

- (1) This device may not cause interference.
- (2) This device must accept any interference, including interference that may cause undesired operation of the device.

Radiofrequency radiation exposure Information: This equipment complies with Canada radiation exposure limits set forth for an uncontrolled environment. This equipment should be installed and operated with minimum distance of 20 centimeters between the radiator and your body. This transmitter must not be co-located or operating in conjunction with any other antenna or transmitter.

L'émetteur/récepteur exempt de licence contenu dans le présent appareil est conforme aux CNR d'Innovation, Sciences et Développement économique Canada applicables aux appareils radio exempts de licence. L'exploitation est autorisée aux deux conditions suivantes :

- (1) L'appareil ne doit pas produire de brouillage;
- (2) L'appareil doit accepter tout brouillage radioélectrique subi, même si le brouillage est susceptible d'en compromettre le fonctionnement.

Informations sur l'exposition aux radiofréquences:

Cet équipement est conforme aux limites d'exposition aux radiations fixées par le Canada pour un environnement non contrôlé. Cet équipement doit être installé et utilisé avec une distance minimale de 20 centimètres entre le radiateur et votre corps. Cet émetteur ne doit pas être co-localisée ou opérant en conjonction avec autre antenne ou émetteur.

United States (USA)

This device complies with part 15 of the FCC Rules. Operation is subject to the following two conditions:

- (1) This device may not cause harmful interference, and
- (2) this device must accept any interference received, including interference that may cause undesired operation.

Changes or modifications made to this equipment not expressly approved by Robert Bosch GmbH may void the FCC authorization to operate this equipment.

NOTE: This equipment has been tested and found to comply with the limits for a Class B digital device, pursuant to Part 15 of the FCC Rules. These limits are designed to provide reasonable protection against harmful interference in a residential installation. This equipment generates, uses and can radiate radio frequency energy and, if not installed and used in accordance with the instructions, may cause harmful interference to radio communications.

However, there is no guarantee that interference will not occur in a particular installation. If this equipment does cause harmful interference to radio or television reception, which can be determined by turning the equipment off and on, the user is encouraged to try to correct the interference by one or more of the following measures:

- Reorient or relocate the receiving antenna.
- Increase the separation between the equipment and receiver.
- Connect the equipment into an outlet on a circuit different from that to which the receiver is connected.
- Consult the dealer or an experienced radio/TV technician for help.

Radiofrequency radiation exposure Information: This equipment complies with FCC radiation exposure limits set forth for an uncontrolled environment. This equipment should be installed and operated with minimum distance of 20 cm between the radiator and your body. This transmitter must not be co-located or operating in conjunction with any other antenna or transmitter.

Japan

This device is granted pursuant to the Japanese Radio Law (電波法) and the Japanese

Telecommunications Business Law (電気通信事業法)

本製品は、電波法と電気通信事業法に基づく適合証明を受けております。

This device should not be modified (otherwise the granted designation number will become invalid)

本製品の改造は禁止されています。
(適合証明番号などが無効となります。)



R

201-200559

T

20 0138 201

Korea

Equipment Name: BMW A-Kombi

Basic model number: ICC10in

Manufacturer/Country of Origin:

Robert Bosch GmbH / 포르투갈

Zertifikatsnummer:

R-R-BO2-ICC10in

Serbia



ID: И011 20

Mexico

La operación de este equipo está sujeta a las siguientes dos condiciones:

- (1) es posible que este equipo o dispositivo no cause interferencia perjudicial y
- (2) este equipo o dispositivo debe aceptar cualquier interferencia, incluyendo la que pueda causar su operación no deseada.

NOM



IFETEL

NYCE

Taiwan, Republic of

取得審驗證明之低功率射頻器材，非經核准，公司、商號或使用者均不得擅自變更頻率、加大功率或變更原設計之特性及功能。低功率射頻器材之使用不得影響飛航安全及干擾合法通信；經發現有干擾現象時，應立即停用，並改善至無干擾時方得繼續使用。前述合法通信，指依電信管理法規定作業之無線電通信。低功率射頻器材須忍受合法通信或工業、科學及醫療用電波輻射性電機設備之干擾。

234 INDEX

- 1**
 - 12V battery
 - Charging, 159, 160
 - General notes, 158
 - Indicator lights, 43
 - Position on vehicle, 15
 - Recharging function, 158
 - Replacing, 161
 - Technical data, 191
 - 12V socket
 - Information on use, 168
 - Position on vehicle, 15
- A**
 - Abbreviations and symbols, 4
 - ABS
 - Indicator lights, 49, 50
 - Self-diagnosis, 123
 - Technology in detail, 134
 - Adaptive front lighting, 143
 - Ambient temperature, 34
 - ASC
 - Indicator lights, 44
 - Self-diagnosis, 123
 - Technology in detail, 137
- B**
 - Bluetooth, 85
 - Brake fluid
 - Checking the fill level, 151
 - Reservoir, 14, 15
 - Brake pads
 - Breaking in, 127
 - Check, 149, 150
 - Brakes
 - ABS Pro in detail, 136
 - Checking function, 149
 - Safety instructions, 127
 - Technical data, 189
 - Break-in, 127
- C**
 - Care
 - Care products, 176
 - Chrome, 178
 - Paint preservation, 179
 - Washing the vehicle, 176
 - Charging
 - Charge current, 111
 - Charging cable, 108
 - Charging procedure, 111, 115
 - Indicator lights, 38, 39, 40, 41, 42
 - Overview, 25
 - State of charge, 82
 - Technical data, 187
 - Charging process
 - Ending, 115
 - Starting, 111
 - Chassis, 189
 - Check Control, 26
 - Checklist, 121
 - Clock, 83
 - Coolant
 - Checking the fill level, 153
 - Indicator lights, 40, 41
 - Reservoir, 14
 - Topping up, 153
 - Cruising range, 82

D

- Diagnostic socket
 - Detaching, 164
 - Fastening, 164
 - Position on vehicle, 14
- Dimensions, 192
- Drive, 188
- Drive display, 81
- DTC
 - Indicator lights, 44
 - Technology in detail, 137
- DWA
 - Indicator light, 18
 - Indicator lights, 37
 - Operating, 63
 - Technical data, 192
- Dynamic Brake Control, 141

E

- Electrical system, 191
- Emergency-off switch
 - Operating, 58
 - Operating element, 17
- Energy recovery
 - Indicator lights, 41
 - Limitation, 81
- E-Scooter
 - Cleaning, 174
 - Lashing down, 129
 - Parking, 128
 - Putting into operation, 180
 - Storage, 180
 - Vehicle care, 174

F

- Fairing
 - Front-fairing panel, 156
 - Side trim panel, 157
- Frame, 188

Fuses

- Position on vehicle, 15
- Replacing, 162

H

- Hazard warning flasher, 61
 - Operating element, 16
- Headlight, 100
- Headlight range
 - Adjustment elements, 14
 - Setting, 100
- Heated grips, 66
- Helmet compartment
 - Emergency unlocking, 70
 - Operating, 69
 - Position on vehicle, 15
- High-voltage battery
 - State of charge, 82
 - Technical data, 187
- High-voltage system, 38, 39, 41
- Horn, 16

I

- Immobilizer, 55
- Indicator lights
 - 12V battery, 43
 - ABS, 49, 50
 - Anti-theft alarm system, 37
 - ASC, 44
 - Charging, 38, 40, 41, 42
 - Coolant, 40, 41
 - DTC, 44
 - Electric drive, 39, 40
 - EME, 37
 - Energy recovery, 41
 - External temperature warning, 34
 - Faulty light source, 35

236 INDEX

- High-voltage system, 38, 39, 41
- Instrument cluster, 18
- Isolation fault, 38
- Keyless Ride, 34, 35
- Layout, 26
- Light control unit failed, 36
- My Vehicle, 88
- Overview, 22
- Performance, 39
- RDC, 46
- Service, 51
- Side stand, 49
- State of charge, 39
- Tire Pressure Monitor (TPM), 45, 46, 47, 48
- Instrument cluster
 - Overview, 18
 - Photodiode, 18

K

- Keyless Ride
 - Battery dead or radio-operated key lost, 56
 - Electronic immobilizer EWS, 55
 - Indicator lights, 34, 35
 - Locking the steering lock, 54
- Keys, 54

L

- Light sources
 - Indicator lights, 35
 - Replacing, 156
 - Technical data, 191
- Lights
 - Adaptive headlight, 143
 - Headlight courtesy delay feature, 60

- Headlight flasher, 60
- High beams, 60
- Low beams, 60
- Operating element, 16
- Parking lights, 60
 - Roadside parking lights, 60
- Loading information, 120
- Luggage, 120

M

- Maintenance confirmations, 202
- Maintenance intervals, 198
- Maintenance schedule, 200
- Media, 94
- Menu, 78
- Mirrors, 100
- Mobility Services, 198
- Multifunction switch
 - Overview, left, 16
 - Overview, right, 17

N

- Navigation, 92

O

- Onboard computer, 91
- Onboard vehicle toolkit
 - Contents, 149
 - Position on vehicle (hook wrench), 15
 - Position on vehicle (Torx T25), 14
- Operating readiness, 54, 55

- Output
 - Indicator lights, 39
 - Limitation, 81
- Outside temperature, 34
- Overview of warning indicators, 28
- Overviews
 - Indicator and warning lights, 22
 - Instrument cluster, 18
 - Left side of vehicle, 14
 - Left-side multifunction switch, 16
 - My Vehicle, 88
 - Right side of vehicle, 15
 - Right-hand multifunction switch, 17
 - TFT display in Charge view, 25
 - TFT display in Pure Ride view, 23
 - TFT display in the Menu view, 24
- P**
 - Pairing, 85
 - Passenger footrests
 - Position on vehicle, left, 14
 - Position on vehicle, right, 15
 - Passenger grab handle
 - Position on vehicle, left, 14
 - Position on vehicle, right, 15
 - Payload table, 15
 - Performance data, 193
 - Phone, 95
 - Pre-Ride-Check, 122

- Programmable memory buttons
 - Assigning functions, 81
 - Operating element, 16
- Pure, 82
- Pure Ride
 - Overview, 23
 - View, 81

R

- Radio-operated key
 - Indicator lights, 34, 35
 - Replacing the battery, 57
- RDC
 - Indicator lights, 45, 46, 47, 48
 - Technology in detail, 142
- Rear-wheel drive, 188
- Recycling, 197
- Reversing
 - Operating, 59
 - Operating element, 16
- Ride readiness
 - Display, 124
 - Establishing, 122
 - Operating element, 17
 - Turning on, 125
- Riding mode
 - Setting, 62
 - Technology in detail, 139
- Road sign detection, 80
- RSC, 139
- S**
 - Safety information
 - For riding, 120
 - For the brake, 127
 - Seat heating, 66

238 INDEX

Service

- BMW Motorrad Service, 197
 - Indicator lights, 51
 - Reporting safety defects, 196
 - Service History, 198
- Service display, 50
- Split screen, 82, 83
- Spring preload
- Rear adjusting element, 14
 - Setting, 101
- Status bar, top, 79
- Storage compartment
- Operating, 67
 - Position on vehicle, 15

T

TFT display

- Charge overview, 25
- Instrument cluster, 18
- Menu overview, 24
- Operating, 78
- Operating elements, 75
- Overview Pure Ride, 23
- Split screen, 82
- Upper status line, 79

Tires

- Breaking in, 127
- Checking tire pressure, 154
- Checking tread depth, 155
- Recommendations, 155
- Tire pressures, 190

Topcase, 169

Transmission, 188

Transport, 129

Troubleshooting chart, 184

Turn signals, 61

- Operating element, 16

Type plate, 15

V

- Vehicle identification number, 15

W

Warning lights

- Instrument cluster, 18
- Overview, 22

Weights, 193

Wheels

- Checking rims, 155
- Technical data, 190

WiFi, 87

The descriptions and illustrations in this manual may vary from your own motorcycle's actual equipment, depending upon its equipment level and accessories as well as your specific national version. No claims will be entertained as a result of such discrepancies. Dimensions, weights, fuel consumption and performance data are quoted to the customary tolerances.

The right to modify designs, equipment and accessories is reserved.

Errors and omissions excepted.

© 2022 Bayerische Motoren Werke Aktiengesellschaft
80788 Munich, Germany
Reprinting, in whole or in part, is only permitted with the written permission of BMW Motorrad, Aftersales.
Original Rider's Manual, printed in Germany.



WARNING

Harmful substances

Operating, servicing, and maintaining a passenger vehicle or off-road vehicle can expose you to chemicals including phthalates and lead, which are known to the State of California to be carcinogenic or detrimental to childbirth or reproduction.

- To reduce the risk, wear gloves or wash your hands frequently when servicing your vehicle.
- Further information is available at:

**[www.P65Warnings.ca.gov/
passenger_vehicle](http://www.P65Warnings.ca.gov/passenger_vehicle)**

Important data:

Charging time

Charging time of the high-voltage battery with standard charging cable



210 min, 80% charge for charge current: 10 A
260 min, 100% charge for charge current: 10 A

Charging time of the high-voltage battery with Mode3 charging cable

–with quick charger^{OE}



65 min, 80% charge for charge current: 30 A
100 min, 100% charge for charge current: 30 A

Tire pressures

Front tire pressure

33.4 psi (2.3 bar), One-up mode, with cold tires
33.4 psi (2.3 bar), Two-up mode with load, with cold tires

Rear tire pressure

36.3 psi (2.5 bar), One-up mode, with cold tires
36.3 psi (2.5 bar), Two-up mode with load, with cold tires

You can find further information on all aspects of your vehicle at:
bmw-motorrad.com

