



**BMW
MOTORRAD**

RIDER'S MANUAL CE 04



MAKE LIFE A RIDE

Vehicle data

Model

Vehicle Identification Number

Colour code

Date of first registration

Registration number

Dealership details

Person to contact in Service department

Ms/Mr

Phone number

Dealership address/phone number (company stamp)

YOUR BMW.

We congratulate you on your choice of a vehicle from BMW Motorrad and welcome you to the community of BMW riders. Familiarise yourself with your new vehicle so that you can ride it safely and confidently in all traffic situations.

About this rider's manual

Read this rider's manual carefully before starting to use your new BMW. It contains important information on how to operate the controls and how to make the best possible use of all your BMW's technical features.

In addition, it contains information on maintenance and care to help you maintain your vehicle's reliability and safety, as well as its value.

If the time comes to sell your BMW, please remember to hand over this rider's manual to the new owner. It is an important part of the vehicle.

We hope you will enjoy riding your BMW and that all your journeys will be pleasant and safe

BMW Motorrad.

01 GENERAL INSTRUCTIONS	2	03 STATUS INDICATORS	24
Quick & easy reference	4	Indicator and warning lights	26
Abbreviations and symbols	4	TFT display in Pure Ride view	27
Equipment	5	TFT display in Menu view	28
Technical data	6	TFT display in Charging view	29
Currency	6	Warning indicators	30
Additional sources of information	6	<hr/>	
Certificates and operating licences	7	04 OPERATION	58
Data memory	7	Operational readiness	60
Intelligent emergency call system	12	Emergency-off switch (kill switch)	64
<hr/>		Intelligent emergency call	65
02 GENERAL VIEWS	16	Reversing	67
General view, left side	18	Lighting	68
General view, right side	19	Riding mode	73
Multifunction switch, left	20	Anti-theft alarm (DWA)	75
Multifunction switch, right	21	Tyre pressure monitoring (RDC)	78
Multifunction switch, right	22	Heating	78
Instrument cluster	23	Storage compartment	79
		Helmet compartment	81
		<hr/>	
		05 TFT DISPLAY	84
		General notes	86
		Principle	87
		Pure Ride view	93
		Pure view	94
		Splitscreen	94
		General settings	95

Bluetooth	97	Brakes	144
WIFI	99	Parking your E-	
My vehicle	100	Scooter	145
On-board computer	103	Securing E-Scooter	
Navigation	104	for transportation	146
Media	106		
Telephone	107		
Display software version	108		
Display licence information	108		
<hr/>			
06 ADJUSTMENT	110	09 ENGINEERING DETAILS	148
Mirrors	112	General notes	150
Headlight	112	Antilock Brake System (ABS)	150
Spring preload	113	Traction control (ASC/DTC)	153
<hr/>		Energy recovery stability control (RSC)	155
07 BMW EPOWER	116	Riding mode	156
Principle	118	Dynamic Brake Control	157
General notes	118	Tyre pressure control (RDC)	158
Charging cable	120	Adaptive headlight	160
Charging process	122		
<hr/>			
08 RIDING	134	10 MAINTENANCE	162
Safety information	136	General notes	164
Comply with checklist	137	Standard toolkit	165
Always before riding off	138	Brake system	165
Every 10th charging process	138	Coolant	169
Establishing riding readiness	138	Tyres	170
Riding the E-Scooter	141	Rims and tyres	171
Running in	143	Lighting	172
		Trim panel components	172
		Battery	174
		Fuses	178
		Diagnostic connector	180

11 ACCESSORIES	182	14 SERVICE	212
General notes	184	Reporting safety-relevant defects	214
Power sockets	184	Recycling	215
Topcase	185	BMW Motorrad	
		Service	215
12 CARE	190	BMW Motorrad	
Care products	192	Service history	216
Washing the vehicle	192	BMW Motorrad mobility services	217
Cleaning easily damaged components	194	Maintenance work	217
Care of paintwork	195	Maintenance schedule	219
Paint preservation	195	BMW Motorrad running-in check	220
Laying up the E-Scooter	196	Maintenance confirmations	221
Restoring E-Scooter to use	196	Service confirmations	233
13 TECHNICAL DATA	198	15 CERTIFICATE	236
Troubleshooting chart	200	BMW CE 04 Battery Certificate for the high-voltage cell modules services and conditions	238
Charging	203		
Drive	204		
Transmission	205		
Final drive	205		
Frame	205		
Chassis and suspension	205		
Brakes	206	APPENDIX	240
Wheels and tyres	206	Declaration of Conformity	241
Electrical system	207	Certificate for electronic immobiliser	244
Anti-theft alarm	209	Certificate for Keyless Ride	247
Dimensions	209		
Weights	210		
Performance figures	210		

Certificate for Keyless Ride	249
Certificate for Keyless Ride	251
Certificate for Keyless Ride	253
Certificate for tyre pressure control (Reifendruck-Control, RDC)	255
Certificate for TFT instrument cluster	256
<hr/>	
INDEX	260

GENERAL INSTRUCTIONS

01

QUICK & EASY REFERENCE	4
ABBREVIATIONS AND SYMBOLS	4
EQUIPMENT	5
TECHNICAL DATA	6
CURRENCY	6
ADDITIONAL SOURCES OF INFORMATION	6
CERTIFICATES AND OPERATING LICENCES	7
DATA MEMORY	7
INTELLIGENT EMERGENCY CALL SYSTEM	12

4 GENERAL INSTRUCTIONS

QUICK & EASY REFERENCE

An important aspect of this rider's manual is that it can be used for quick and easy reference. Consulting the extensive index at the end of this rider's manual is the fastest way to find information on a particular topic or item. To first read an overview of your E-Scooter, please go to Chapter 2. All maintenance and servicing work on the vehicle is documented in the "Service" section. The record of the maintenance work you have had performed on your vehicle is a precondition for generous treatment of goodwill claims.





Warning signs on vehicle components

Warning signs on vehicle components draw attention to the fact that incorrect use of the high-voltage technology or high-voltage components en-

tails the risk of life-threatening injury due to electric shock.

ABBREVIATIONS AND SYMBOLS

 **CAUTION** Low-risk hazard. Non-avoidance can lead to slight or moderate injury.

 **WARNING** Medium-risk hazard. Non-avoidance can lead to fatal or severe injury.

 **DANGER** High-risk hazard. Non-avoidance leads to fatal or severe injury.

 **ATTENTION** Special notes and precautionary measures. Non-compliance can lead to damage to the vehicle or accessory and, consequently, to voiding of the warranty.

 Specific instructions on how to operate, control, adjust or look after items of equipment on the motorcycle.

- Instruction.
- » Result of an activity.
- ▣ Reference to a page with more detailed information.

◁ Indicates the end of a passage relating to specific accessories or items of equipment.



Tightening torque.



Technical data.

NV National-market version.

OE Optional equipment. The vehicles are assembled complete with all the BMW Motorrad optional equipment originally ordered.

OA Optional accessories. You can obtain BMW Motorrad optional accessories through your authorised BMW Motorrad dealer; optional accessories have to be retrofitted to the vehicle.

ABS Anti-lock brake system.

ASC Automatic Stability Control.

DTC Dynamic Traction Control.

DWA Anti-theft alarm.

EWS Electronic immobiliser.

RDC Tyre pressure monitoring.

RSC Recuperation stability control

EQUIPMENT

When you ordered your E-Scooter, you chose various items of custom equipment. This Rider's Manual describes optional extras (OE) offered by BMW and selected optional accessories (OA). This explains why the manual may also contain descriptions of equipment that you might not have selected. Please note, too, that on account of country-specific differences, your vehicle might not be exactly as illustrated. If your E-Scooter was supplied with equipment not described in this Rider's Manual, you will find these features described in separate operating instructions.

6 GENERAL INSTRUCTIONS

TECHNICAL DATA

All dimensions, weights and power ratings stated in the rider's manual are quoted to the standards and comply with the tolerance requirements of the Deutsches Institut für Normung e. V. (DIN).

Technical data and specifications in this rider's manual are guide values. The vehicle-specific data may deviate from these, for example as a result of selected optional equipment, the national-market version or country-specific measuring procedures. Detailed values can be taken from the vehicle registration documents, or can be obtained from your authorised BMW Motorrad retailer or another qualified service partner or specialist workshop. The specifications in the vehicle documents always have priority over the information provided in this rider's manual.

CURRENCY

The high safety and quality standards of BMW E-Scooters are maintained by constant development work on designs, equipment and accessories. Because of this, your vehicle

may differ from the information supplied in the rider's manual. Nor can BMW Motorrad entirely rule out errors and omissions. We hope you will appreciate that no claims can be entertained on the basis of the data, illustrations or descriptions in these operating instructions.

ADDITIONAL SOURCES OF INFORMATION

Authorised BMW Motorrad retailer

Your authorised BMW Motorrad retailer will be happy to answer any questions you may have.

Internet

The rider's manual for your vehicle, operating and installation instructions for accessories and general information about BMW Motorrad, in relation to technology, for example, are available for download from bmw-motorrad.com/manuals.

CERTIFICATES AND OPERATING LICENCES

The certificates for the vehicle and the official operating licences for accessories can be downloaded from bmw-motorrad.com/certification.

DATA MEMORY

General

Control units are installed in the vehicle. Control units process data that they receive, for example, from vehicle sensors, or that they generate themselves or exchange between each other. Some control units are required for the vehicle to function safely or provide assistance during riding, for example assistance systems. In addition, control units enable comfort or infotainment functions.

Information on data that has been stored or exchanged can be obtained from the manufacturer of the vehicle, for example via a separate booklet.

Personal reference

Each vehicle is identified with a clear vehicle identification number. Depending on the country, the vehicle identification number, the number plate and the corresponding authorities can be referenced to ascertain the vehicle owner. There are also other ways to use data obtained from the vehicle to trace the rider or vehicle owner, for example using the Connected-Drive user account.

Data protection rights

In accordance with applicable data protection laws, vehicle users have certain rights in relation to the manufacturer of the vehicle or in relation to companies which collect or process personal data.

Vehicle users have the right to obtain full information at no cost from persons or entities storing personal data of the vehicle user.

These entities may include:

- Manufacturer of the vehicle
- Qualified service partners
- Specialist workshops
- Service providers

Vehicle users have the right to request information on what personal data has been stored,

8 GENERAL INSTRUCTIONS

for what purpose the data is used, and where the data comes from. To obtain this information, proof of ownership or use is required.

The right to information also includes information about data that has been shared with other companies or entities. The website of the vehicle manufacturer contains the applicable data protection information. This data protection information includes information on the right to have data deleted or corrected. The manufacturer of the vehicle also provides their contact details and those of the data protection officer on their website.

The vehicle owner can also request that a BMW Motorrad retailer or another qualified service partner or specialist workshop read out the data that is stored in the vehicle for a charge.

The vehicle data is read out using the legally prescribed socket for on-board diagnosis (OBD) in the vehicle.

Legal requirements for the disclosure of data

As part of its legal responsibilities, the manufacturer of the vehicle is obligated to make its stored data available to the relevant authorities. This data is provided in the required scope in individual cases, for example to clarify a criminal offence. In the context of applicable laws, public agencies are entitled in individual cases to read out data from the vehicle themselves.

Operating data in the vehicle

Control units process data to operate the vehicle.

This includes, for example:

- Status reports of the vehicle and its individual components, for example wheel speed, wheel circumferential velocity, deceleration
- Environmental conditions, for example temperature

The data is only processed in the vehicle itself and is generally non-permanent. The data is not stored beyond the operating period.

Electronic components, for example control units, contain components for storing technical information. Information

can be temporarily or permanently stored on the vehicle condition, component loads, incidents or errors.

This information is generally used to document the condition of a component, a module, a system or the surrounding area, for example:

- Operating conditions of system components, for example filling levels, tyre pressure
- Malfunctions and faults in important system components, for example light and brakes
- Response of the vehicle in special riding situations, for example engagement of the driving dynamics systems
- Information on incidents resulting in damage to the vehicle

The data is necessary for the provision of control unit functions. Furthermore, the data is used to detect and rectify malfunctions and to enable the vehicle manufacturer to optimise vehicle functions.

The vast majority of this data is non-permanent and is only processed in the vehicle itself. Only a small amount of the data is stored in incident or

fault memories as required by events.

If services are accessed, for example repairs, service processes, warranty cases and quality assurance measures, this technical information can be read out of the vehicle together with the vehicle identification number.

The information can be read out by a BMW Motorrad retailer or another qualified service partner or specialist workshop. The legally stipulated socket for on-board diagnosis (OBD) in the vehicle is used to read out the data. The data is obtained, processed and used by the relevant parts of the retailer network. The data is used to document the technical conditions of the vehicle, to help with error localization, to comply with warranty obligations and to improve quality.

In addition, the manufacturer has various product monitoring obligations arising from product liability legislation. To meet these obligations, the vehicle manufacturer requires technical data from the vehicle. The data from the vehicle can

10 GENERAL INSTRUCTIONS

also be used to check warranty claims from the customer.

Error and incident memories in the vehicle can be reset during servicing or repair work by a BMW Motorrad retailer or another qualified service partner or specialist workshop.

Data input and data transfer in the vehicle

General

Depending on the equipment, comfort and customised settings can be stored in the vehicle and can be changed or reset at any time.

If required, data can be entered in the entertainment and communication system of the vehicle, for example using a smartphone.

Depending on the individual equipment, this includes:

- Multimedia data, such as music for playback
- Contacts data for use in connection with a communication system or an integrated navigation system
- Entered destinations
- Data on the use of internet services. This data can be stored locally in the vehicle or is located on a device that is connected to the vehicle,

for example smartphone, USB stick, MP3 player. If this data is stored in the vehicle, the data can be deleted at any time.

This data is transferred to third parties only if personally requested within the context of using online services. This depends on the selected settings when using the services.

Incorporation of mobile devices

Depending on the equipment, mobile devices connected to the vehicle, for example smartphones, can be controlled using the operating elements of the vehicle.

The image and sound of the mobile device can then be output via the multimedia system. At the same time, specific information is transferred to the mobile device. Depending on the type of integration, this includes, for example, position data and additional general vehicle information. This enables optimal use of the selected apps, for example navigation or music playback.

The type of additional data processing is determined by the provider of the respective app.

The scope of the possible settings depends on the corresponding app and the operating system of the mobile device.

Services

General

If the vehicle has a wireless connection, this enables the exchange of data between the vehicle and other systems. The wireless connection is enabled by the vehicle's own transceiver unit or using personally integrated mobile devices, for example smartphones. Online functions can be accessed through this wireless connection. These include online services and apps that are provided by the vehicle manufacturer or by other providers.

Services of the vehicle manufacturer

For online services of the vehicle manufacturer, the individual functions are described at suitable points, for example rider's manual, website of the manufacturer. At the same time, information is also provided on the relevant data protection law. Personal data may be used to provide online services. Data

is exchanged using a secure connection, for example with the IT systems provided by the vehicle manufacturer.

Obtaining, processing and using personal data outside of the normal provision of services requires legal permission, contractual agreement or consent. It is also possible to have the entire data connection activated or deactivated. Statutory functions are excluded from this.

Services from other providers

When using online services from other providers, these services are subject to the responsibility and the data protection and operating conditions of the individual provider. The vehicle manufacturer has no influence on the content that is exchanged in this instance. Information on the type, scope and purpose of the data capture and use of personal data as part of the services of third parties can be ascertained from the individual provider.

12 GENERAL INSTRUCTIONS

INTELLIGENT EMERGENCY CALL SYSTEM

—with intelligent emergency call^{OE}

Principle

The intelligent emergency call system enables manual or automatic emergency calls, for example in the event of an accident.

The emergency calls are received by an emergency call centre that is commissioned by the vehicle manufacturer.

For more information on the intelligent emergency call system and its functions, see the section entitled "Operation" (▣▣▣▣ 65).

Legal basis

Processing of personal data using the intelligent emergency call system is in line with the following regulations:

- Protection of personal data: Directive 95/46/EC of the European Parliament and of the Council.
- Protection of personal data: Directive 2002/58/EC of the European Parliament and of the Council.

The legal basis for the activation and function of the intelligent emergency call system is the concluded Connected-Ride contract for this function, as well as the corresponding laws, ordinances and directives of the European Parliament and of the European Council.

The relevant ordinances and directives regulate the protection of natural persons during the processing of personal data.

The processing of personal data by the intelligent emergency call system satisfies the European directives for the protection of personal data.

The intelligent emergency call system processes personal data only with the agreement of the vehicle owner.

The intelligent emergency call system and other services with additional benefits can process personal data only with the express permission of the person affected by the data processing, for example the vehicle owner.

SIM card

The intelligent emergency call system operates via the mobile phone network using the SIM card installed in the vehicle.

The SIM card is permanently logged into the mobile phone network to enable rapid connection setup. Data is sent to the vehicle manufacturer in the event of an emergency.

Improving quality

The data that is transferred in an emergency is also used by the manufacturer of the vehicle to improve product and service quality.

Location determination

The position of the vehicle can be determined exclusively by the mobile phone network provider based on the mobile phone site locations. It is not possible for the provider to trace a connection between the vehicle's VIN and the phone number of the installed SIM card. Only the manufacturer of the vehicle can link a VIN and the phone number of the SIM card installed in a particular vehicle.

Log data of emergency calls

The log data of emergency calls is stored in a memory of the vehicle. The oldest log data is regularly deleted. The log data includes, for example, information on when and where an emergency call was made. In exceptional cases, the log data can be read out of the vehicle memory. As a rule, log data is only read out following a court order, and this is only possible if the corresponding devices are connected directly to the vehicle.

Automatic emergency call

The system is designed so that, following a sufficiently serious accident, which is detected by sensors in the vehicle, an emergency call is automatically activated.

Sent information

When making an emergency call using the intelligent emergency call system, the system forwards the same information to the designated emergency call centre as is forwarded to the public emergency operations centre by the statutory emergency call system eCall. In addition, the intelligent emergency call system sends

14 GENERAL INSTRUCTIONS

the following additional information to an emergency call centre commissioned by the vehicle manufacturer and, if required, to the emergency services:

- Accident data, for example the direction of impact detected by the vehicle sensors, to assist the emergency services response.
- Contact details, for example the phone number of the installed SIM card and the phone number of the rider, if available, to enable rapid contact with those involved in the accident if required.

Data storage

The data for an activated emergency call is stored in the vehicle. The data contains information on the emergency call, for example the location and time of the emergency call. The voice recordings of the emergency call are stored at the emergency call centre. The voice recordings of the customer are stored for 24 hours in case details of the emergency call need to be analysed. After this, the voice recordings are deleted. The voice recordings of the employee of

the emergency call centre are stored for 24 hours for quality assurance purposes.

Information on personal data

The data that is processed as part of the intelligent emergency call is processed exclusively to carry out the emergency call. As part of its statutory obligation, the manufacturer of the vehicle provides information about the data that it has processed and any data that it still has stored.

GENERAL VIEWS

02

GENERAL VIEW, LEFT SIDE	18
GENERAL VIEW, RIGHT SIDE	19
MULTIFUNCTION SWITCH, LEFT	20
MULTIFUNCTION SWITCH, RIGHT	21
MULTIFUNCTION SWITCH, RIGHT	22
INSTRUMENT CLUSTER	23

18 GENERAL VIEWS

GENERAL VIEW, LEFT SIDE

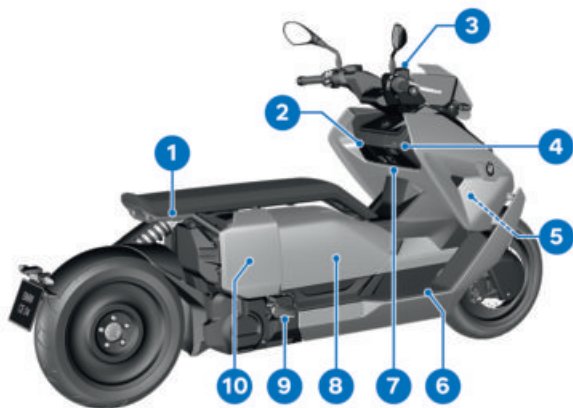

- | | |
|---|------------------------------------|
| <p>1 Behind the front trim panel:
Diagnostic connector (▶▶▶ 180)
Headlight beam-throw adjustment (▶▶▶ 112)
Coolant reservoir (▶▶▶ 169)
On-board toolkit, Torx T25 (▶▶▶ 165)</p> <p>2 Brake-fluid reservoir for the rear-wheel brake (▶▶▶ 167)</p> <p>3 Passenger grab handle</p> <p>4 Adjusting spring preload for spring strut (▶▶▶ 113)</p> <p>5 rear footrest</p> | <p>6 Rider's footboards</p> |
|---|------------------------------------|

GENERAL VIEW, RIGHT SIDE

- | | |
|--|---|
| <p>1 Passenger grab handle</p> <p>2 Storage compartment (► 79)</p> <p>3 Brake-fluid reservoir for the front-wheel brake (► 167)</p> <p>4 Charging compartment (► 123)</p> <p>5 Vehicle identification number (main frame, front right at bottom)
Type plate (frame, front right, on steering head)</p> <p>6 Rider's footboards</p> <p>7 12 V socket</p> | <p>8 Helmet compartment (► 81)
On-board tool for adjusting spring preload (► 165)
Payload table and tyre pressures table (on inside of helmet compartment hinged lid)</p> <p>9 rear footrest</p> <p>10 Behind the side trim panel:
Battery (► 174)
Fuses (► 178)</p> |
|--|---|

20 GENERAL VIEWS

MULTIFUNCTION SWITCH, LEFT



- 1 High-beam headlight and headlight flasher (►► 69)
- 2 Hazard warning lights (►► 72)
- 3 Favourites buttons (►► 93)
- 4 Reversing (►► 67)
- 5 Turn indicators (►► 73)
- 6 Horn
- 7 MENU rocker button
- 8 Multi-Controller
- 9 Daytime riding light (►► 70)

MULTIFUNCTION SWITCH, RIGHT

—with intelligent emergency call^{OE}

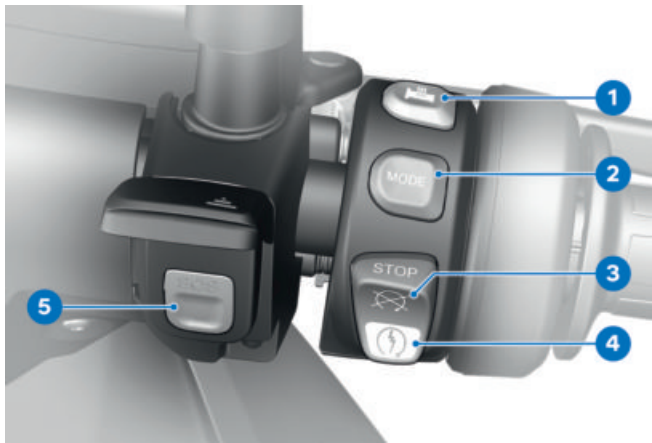

- 1 Heating (➡ 78)
- 2 Riding mode (➡ 74)
- 3 Emergency-off switch (kill switch) (➡ 64)
- 4 Starter button (➡ 141)
- 5 SOS button
Intelligent emergency call
(➡ 65)

22 GENERAL VIEWS

MULTIFUNCTION SWITCH, RIGHT

—without intelligent emergency call^{OE}

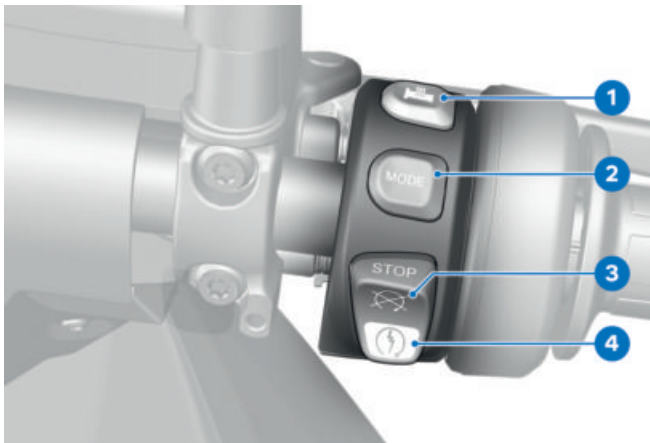

- 1 Heating (➡ 78)
- 2 Riding mode (➡ 74)
- 3 Emergency-off switch (kill switch) (➡ 64)
- 4 Starter button (➡ 141)

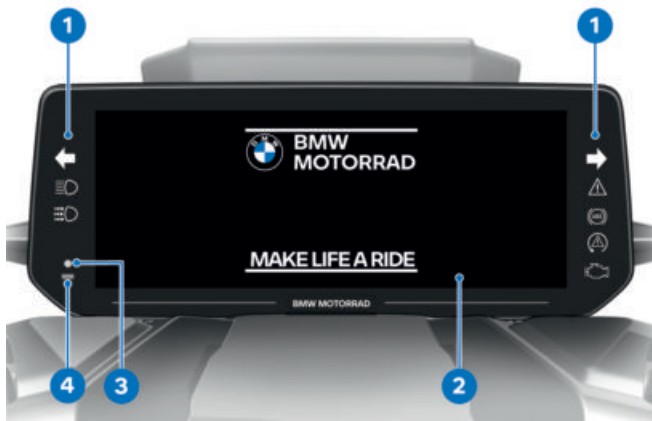
INSTRUMENT CLUSTER

- 1** Indicator and warning lights (➡ 26)
- 2** TFT display (➡ 27)
(➡ 28)
- 3** Alarm system LED
-with anti-theft alarm
(DWA)^{OE}
Alarm signal (➡ 75)
Indicator light for the radio-operated key
Switch on operational readiness. (➡ 61)
- 4** Photosensor (for adapting the brightness of the instrument lighting)

STATUS INDICATORS

03

INDICATOR AND WARNING LIGHTS	26
TFT DISPLAY IN PURE RIDE VIEW	27
TFT DISPLAY IN MENU VIEW	28
TFT DISPLAY IN CHARGING VIEW	29
WARNING INDICATORS	30

26 STATUS INDICATORS

INDICATOR AND WARNING LIGHTS



- | | |
|---|--|
| 1 Turn indicators, left
(►►► 73) | 8 Manual daytime riding
light (►►► 70) |
| 2 High-beam headlight
(►►► 69) | |
| 3 General warning light
(►►► 30) | |
| 4 Turn indicators, right
(►►► 73) | |
| 5 Warning light, drive mal-
function
Drive malfunction (►►► 42) | |
| 6 ASC (►►► 48)
-with riding modes Pro ^{OE}
DTC (►►► 48) | |
| 7 ABS (►►► 55) | |

TFT DISPLAY IN PURE RIDE VIEW

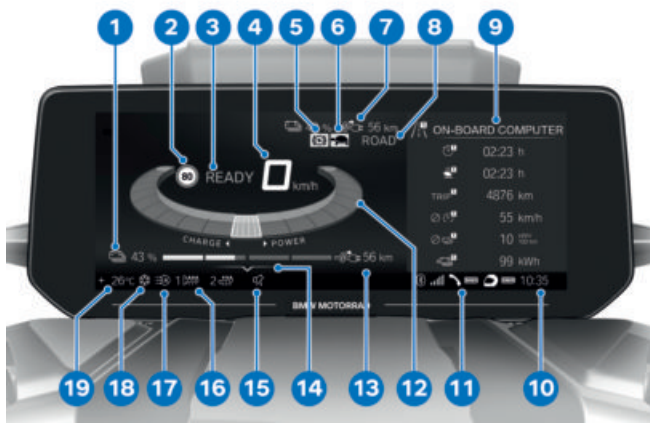

- | | |
|--|--|
| 1 Battery charge state (►► 94) | 12 Drive gauge (►► 93) |
| 2 Speed Limit Info (►► 92) | 13 Range (►► 94) |
| 3 Riding readiness indicator (►► 141) | 14 Operating help |
| 4 Speedometer | 15 Muting (►► 95) |
| 5 Energy recovery limitation (►► 93) | 16 Heating (►► 78) |
| 6 Power limitation (►► 93) | 17 Automatic daytime riding light (►► 70) |
| 7 Rider info. status line (►► 91) | 18 Outside temperature warning (►► 38) |
| 8 Riding mode (►► 73) | 19 Ambient temperature |
| 9 Splitscreen (►► 94) | |
| 10 Clock (►► 95) | |
| 11 Connection status (►► 98) | |

28 STATUS INDICATORS

TFT DISPLAY IN MENU VIEW

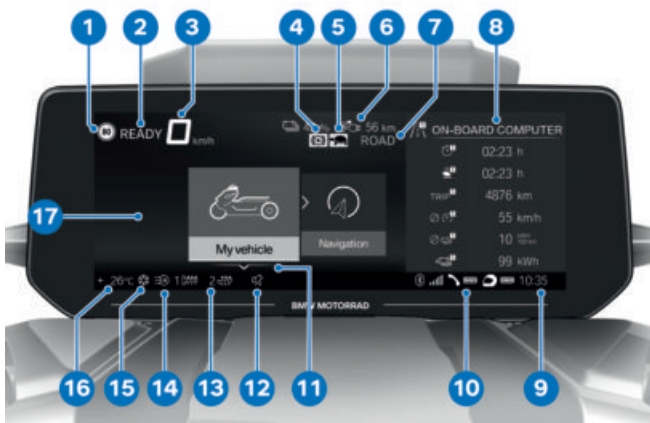

- | | |
|---|---|
| 1 Speed Limit Info (►► 92) | 12 Muting (►► 95) |
| 2 Riding readiness indicator
Switch on riding readiness. (►► 141) | 13 Heating (►► 78) |
| 3 Speedometer | 14 Automatic daytime riding
light (►► 70) |
| 4 Energy recovery limitation
(►► 93) | 15 Outside temperature
warning (►► 38) |
| 5 Power limitation (►► 93) | 16 Ambient temperature |
| 6 Rider info. status line
(►► 91) | 17 Menu section |
| 7 Riding mode (►► 73) | |
| 8 Splitscreen (►► 94) | |
| 9 Clock (►► 95) | |
| 10 Connection status
(►► 98) | |
| 11 Operating help | |

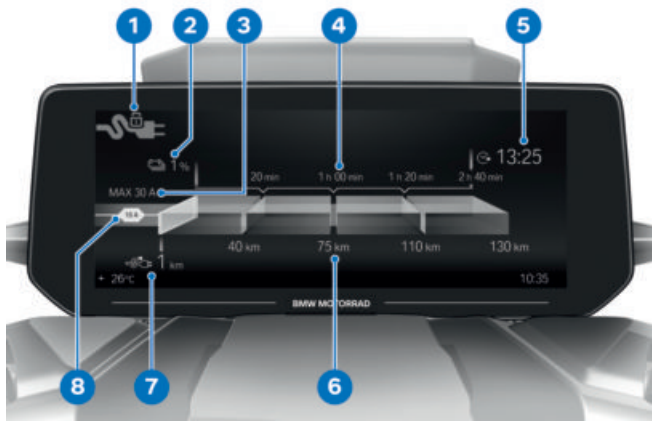
TFT DISPLAY IN CHARGING VIEW

- 1 Status of charging plug
- 2 State of charge
- 3 Maximum available charge current strength
- 4 Charging time forecast
- 5 Target time for 100 % charged
- 6 Range forecast
- 7 Range
- 8 Active charge current limitation

30 STATUS INDICATORS

WARNING INDICATORS

Mode of presentation

Warnings are indicated by the corresponding warning lights. Warnings are indicated by the 'General' warning light showing in combination with a dialogue in the TFT display. The 'General' warning light shows yellow or red, depending on the urgency of the warning.

 The status of the 'General' warning light matches the most urgent warning. The possible warnings are listed on the next pages.

- Green CHECK OK **1**: No message, optimum values.
- White circle with small "i" **2**: Information.
- Yellow warning triangle **3**: Warning, value not ideal.
- Red warning triangle **3**: Warning, value critical



Check Control display

The messages differ in how they show on the display. Different colours and symbols are used depending on priority:

Values display

Symbols **4** differ in how they show on the display. The colours used differ and reflect the urgency of the message. Along with numerical values **8** with units **7**, texts **6** are displayed as well:

Colour of the symbol

- Green: (OK) Current value is ideal.
- Blue: (Cold!) Current temperature is low.
- Yellow: (Low!/High!) Current value is too low or too high.

- Red: (Hot!/High!) Current temperature or value is too high.
- White: (---) No valid value available. Dashes **5** are displayed instead of a numerical value.

 The assessment of some values is only possible from a certain journey duration or speed. If a measured value is still not being displayed because the conditions for measurement have not been met, dashes are displayed instead as a placeholder. If there are no valid measured values, there will be no assessment in the form of a coloured symbol.

- If there are two or more Check Control messages of equal priority, the messages keep changing in the order of their occurrence until they are acknowledged.
- If symbol **2** is actively displayed, it can be acknowledged by tilting the Multi-Controller to the left.
- Check Control messages are attached dynamically to the pages as additional tabs in the *My vehicle* menu ( 89). The message can be called up again as long as the fault persists.

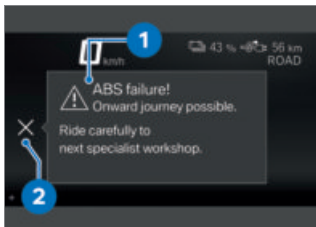









































Check Control dialogue

Messages are output as Check Control dialogues **1**.



















32 STATUS INDICATORS





















Warnings, overview

Indicator and warning lights	Display text	Meaning
	 is displayed.	Outside temperature warning (▣▣▣▣ 38)
 lights up yellow.	 Remote key not in range.	Radio-operated key out of range (▣▣▣▣ 38)
 lights up yellow.	 Keyless Ride failure	Keyless Ride failed (▣▣▣▣ 39)
 lights up yellow.	 Remote key battery at 50%.	Replacing battery of radio-operated key (▣▣▣▣ 39)
	 Remote key battery weak.	
 lights up yellow.	 The faulty bulb is displayed.	Bulb faulty (▣▣▣▣ 39)
 lights up yellow.	 Light control failure!	Light control failed (▣▣▣▣ 40)
	 Alarm system batt. capacity weak.	Anti-theft alarm battery weak (▣▣▣▣ 41)
	 Alarm system battery empty.	Anti-theft alarm battery flat (▣▣▣▣ 41)
	 Alarm system failure	DWA failed (▣▣▣▣ 41)
 lights up.	 Engine!	Drive malfunction (▣▣▣▣ 42)
 flashes red.	 Serious fault in the engine control!	Serious drive malfunction (▣▣▣▣ 42)
 flashes.		































Indicator and warning lights	Display text	Meaning
 lights up yellow.	 No communication with drive electronics.	Communication fault in the electrical machine electronics (▣▣▣▣ 42)
 lights up.		
 lights up yellow.	 Insulation fault in HV system.	Insulation fault in the high-voltage system (▣▣▣▣ 42)
 lights up red.	 Insulation fault in HV system.	Serious insulation fault in the high-voltage system (▣▣▣▣ 43)
	 Charge level low.	State of charge low (▣▣▣▣ 43)
 lights up yellow.	 Charge level critical.	State of charge critical (▣▣▣▣ 43)
	 shows.	
 lights up yellow.	 Fault in e-Drive: Power reduced.	Fault in electric drive: Power reduced (▣▣▣▣ 43)
	 shows.	
 lights up yellow.	 Fault in e-Drive.	High-voltage system cannot be switched on or switched off (▣▣▣▣ 44)
 lights up yellow.	 Fault in e-Drive.	Fault in electric drive (▣▣▣▣ 44)
 lights up yellow.	 Cable lock damaged.	Plug locking problem (▣▣▣▣ 44)







34 STATUS INDICATORS

Indicator and warning lights	Display text	Meaning
 flashes red.	 Serious fault in e-Drive!	Serious fault in electric drive (▣▣▣ 45)
 lights up yellow.	 Drive system too hot: Power reduced.	Propulsion system too hot (▣▣▣ 45)
 lights up yellow.	 Charging interruption Chrg sys overheated.	Charging system overheated (▣▣▣ 45)
 lights up yellow.	 Recuperation limited.	Energy recovery restricted (▣▣▣ 46)
	 shows.	
 lights up yellow.	 Service disconnect pulled.	High-voltage safety switch (Service Disconnect) disconnected (▣▣▣ 46)
	 Chg. target not reached Chg. power reduced	Reduced charging power (▣▣▣ 46)
 lights up yellow.	 Fault in the charging infrastructure.	Fault in the charging infrastructure (▣▣▣ 46)
 lights up yellow.	 Charging system fault.	Fault in the charging system (▣▣▣ 47)
 lights up yellow.	 On-board battery status.	Condition of on-board electrical system battery (12 V battery) (▣▣▣ 47)

Indicator and warning lights	Display text	Meaning
 lights up yellow.	 is displayed in yellow.	On-board system voltage low (▣▣▣ 48)
	 Vehicle voltage low.	
 lights up yellow.	 is displayed in yellow.	Voltage of the vehicle electrical system critical (▣▣▣ 48)
	 Vehicle voltage critical!	
 quick-flashes.		ASC/DTC intervention (▣▣▣ 48)
 lights up yellow.	 Traction control limited!	ASC/DTC restricted (▣▣▣ 48)
 shows.		
 lights up yellow.	 Traction control systems failed!	ASC/DTC failed (▣▣▣ 49)
 shows.		
 lights up yellow.	 is displayed in yellow.	Tyre pressure close to limit of permitted tolerance (▣▣▣ 51)
	 Tyre pressure does not match setpoint	
 flashes red.	 is displayed in red.	Tyre pressure outside permitted tolerance (▣▣▣ 51)
	 Tyre pressure does not match setpoint	
	 Tyre press. control. Loss of pressure.	

36 STATUS INDICATORS

Indicator and warning lights	Display text	Meaning
	"---"	Transmission fault ( 52)
 lights up yellow.	 "---"	Sensor faulty or system fault ( 53)
 lights up yellow.	 RDC sensor battery weak.	Battery for tyre pressure sensor weak ( 53)
 lights up yellow.	 Tyre pressure check failure!	Tyre pressure monitoring (RDC) failed ( 53)
 lights up yellow.	 Emergency call system restricted.	Emergency call function restricted ( 54)
 lights up yellow.	 Emergency call system error.	Emergency call function failed ( 54)
 lights up yellow.	 Side stand monitoring faulty.	Side stand monitoring is faulty ( 54)
 flashes regularly.		ABS self-diagnosis not completed ( 55)
 lights up yellow.	 Limited ABS availability!	ABS fault ( 55)
 shows.		
 lights up yellow.	 ABS failure!	ABS failed ( 55)
 shows.		

Indicator and warning lights	Display text	Meaning
 lights up yellow.  shows.	 ABS Pro failure!	ABS Pro failed (→ 56)
	 is displayed in white. Service due!	Service due (→ 57)
 lights up yellow.	 is displayed in yellow. Service overdue!	Service-due date has passed (→ 57)

38 STATUS INDICATORS

Ambient temperature

The outside temperature is displayed in the status line of the TFT display.

When the vehicle is at a standstill, the heat of the electrical machine can falsify the ambient-temperature reading. If the heat of the electrical machine is affecting it too much, dashes are temporarily shown in place of the value.



There is a risk of black ice if the ambient temperature falls below the limit value of approx. 3 °C.

The first time the temperature drops below this value, the ambient-temperature reading and the ice crystal symbol flash in the status line of the TFT display.

Outside temperature warning



is displayed.

Possible cause:



The air temperature measured at the vehicle is lower than:

approx. 3 °C



WARNING

Risk of black ice forming even when temperature is above approx. 3 °C

Risk of accident

- Always take extra care when temperatures are low; remember that there is particular danger of black ice forming on bridges and where the road is in shade.

- Ride carefully and think well ahead.

Radio-operated key out of range



lights up yellow.



Remote key not in range. Not possible to switch on ignition again.

Possible cause:

Communication between radio-operated key and engine electronics is disrupted.

- Check the battery in the radio-operated key.
- Replace the battery of the radio-operated key. (→ 63)
- Use the spare key to continue your journey.

- Battery of the radio-operated key is empty or loss of the radio-operated key. (►►► 62)
- Remain calm if the Check Control dialogue appears on the display while you are riding. You can continue your journey, operational readiness will not switch off.
- Have the faulty radio-operated key replaced by an authorised BMW Motorrad retailer.

Keyless Ride failed



lights up yellow.



Keyless Ride failure
Do not stop the engine. It may not be possible to restart the engine.

Possible cause:

The Keyless Ride control unit has diagnosed a communication fault.

- Do not switch off riding readiness. Proceed as directly as possible to an authorised workshop, preferably an authorised BMW Motorrad retailer.
- » Riding readiness can no longer be switched on with Keyless Ride.
- » DWA can no longer be activated.

Replacing battery of radio-operated key



lights up yellow.



Remote key battery at 50%. No functional impairment.



Remote key battery weak. Function limited. Change battery.

Possible cause:

- The integral battery in the radio-operated key has lost a significant proportion of its original capacity. There is no assurance of how long the radio-operated key can remain operational.
- Replace the battery of the radio-operated key. (►►► 63)

Bulb faulty



lights up yellow.



The faulty bulb is displayed:



High beam faulty!



Front left turn indicator faulty! or
Front right turn indicator faulty!



Low-beam headlight faulty!

40 STATUS INDICATORS



Front side light faulty!

-with daytime riding light^{OE}



Daytime riding light faulty!◁



Tail light faulty!



Brake light faulty!



Rear left turn indicator faulty! or
Rear right turn indicator faulty!



Number plate light faulty!

-Have it checked by a specialist workshop.



WARNING

Vehicle overlooked in traffic due to failure of the lights on the vehicle

Safety risk

- Replace defective bulbs as soon as possible; always carry a complete set of spare bulbs if possible.

Possible cause:

One or more bulbs faulty.

- Visually inspect to ascertain which bulb is defective.
- Have LED light sources replaced as complete units; consult a specialist workshop, preferably an authorised BMW Motorrad retailer.

Light control failed



lights up yellow.



Light control failure! Have it checked by a specialist workshop.



WARNING

Vehicle overlooked in traffic on account of failure of the vehicle lighting

Safety risk

- Have the fault rectified as quickly as possible by a specialist workshop, preferably an authorised BMW Motorrad retailer.

The vehicle lighting has partially or completely failed.

Possible cause:

Light control has diagnosed a communication fault.

- Have the fault rectified as quickly as possible by a specialist workshop, preferably an authorised BMW Motorrad retailer.

Anti-theft alarm battery weak

—with anti-theft alarm (DWA)^{OE}

 Alarm system batt. capacity weak. No restrictions. Make an appointment at a specialist workshop.

 This error message shows briefly only after the Pre-Ride-Check completes.

Possible cause:

The integral battery in the anti-theft alarm has lost a significant proportion of its original capacity. There is no assurance of how long the anti-theft alarm can remain operational if the vehicle's battery is disconnected.

- Consult a specialist workshop, preferably an authorised BMW Motorrad retailer.

Anti-theft alarm battery flat

—with anti-theft alarm (DWA)^{OE}

 Alarm system battery empty. No independent alarm. Make an appointment at a specialist workshop.

 This error message shows briefly only after the Pre-Ride-Check completes.

Possible cause:

The integral battery in the anti-theft alarm has lost its entire original capacity. There is no assurance that the anti-theft alarm will be operational if the vehicle's battery is disconnected.

- Consult a specialist workshop, preferably an authorised BMW Motorrad retailer.

DWA failed

 Alarm system failure. Have it checked by a specialist workshop.

Possible cause:

The DWA control unit has diagnosed a communication fault.

- Consult a specialist workshop, preferably an authorised BMW Motorrad retailer.
- » DWA can no longer be activated or deactivated.

42 STATUS INDICATORS

» False alarm possible.

Drive malfunction



lights up.



Engine! Have it checked by a specialist workshop.

Possible cause:

The electronic control unit has diagnosed a fault.

- Have the fault rectified by a specialist workshop, preferably an authorised BMW Motorrad retailer.

» You can continue to ride.

Serious drive malfunction



flashes red.



flashes.



Serious fault in the engine control! Riding at mod. speed pos. Damage possible. Have checked by workshop.

Possible cause:

The electrical machine control unit has diagnosed a fault that can lead to damage to the drive components.

- Have the fault rectified as quickly as possible by a specialist workshop, preferably an

authorised BMW Motorrad retailer.

» It is possible to continue to ride but not recommended.

Communication fault in the electrical machine electronics



lights up yellow.



lights up.



No communication with drive electronics. Multiple systems affected. Have them checked by a specialist workshop.

Possible cause:

The electrical machine electronics have diagnosed a communication fault.

- Have the fault rectified as quickly as possible by a specialist workshop, preferably an authorised BMW Motorrad retailer.

Insulation fault in the high-voltage system



lights up yellow.



Insulation fault in HV system. Limited onward journey possible. Drive carefully to the

nearest specialist garage.

Possible cause:

An insulation fault has been detected. A high-voltage cable or a high-voltage component has suffered damage.

- Have all modifications and work on the high-voltage system carried out by an authorised BMW Motorrad retailer with appropriately trained personnel.

Serious insulation fault in the high-voltage system

 lights up red.

 Insulation fault in HV system. Engine restart not possible after engine stop. Find a workshop immediately.

Possible cause:

A serious insulation fault has been detected. A high-voltage cable or a high-voltage component has suffered damage. When the ride ends it will not be possible to restart the vehicle. Damage to the vehicle is possible.

- Immediately consult an authorised BMW Motorrad

retailer with appropriately trained personnel.

State of charge low

 Charge level low. Travel to charging station.

Possible cause:

The vehicle's state of charge is low.

- Proceed to a charging station and recharge the vehicle.

State of charge critical

 lights up yellow.

 Charge level critical. Power reduced. Travel to charging station.

 shows.

WARNING

Unusual driving behaviour during emergency operation of the electric drive

Risk of accident

- Avoid accelerating sharply and overtaking.

Fault in electric drive: Power reduced

 lights up yellow.

44 STATUS INDICATORS

 Fault in e-Drive:
Power reduced. Limited onward journey possible. Drive carefully to nearest specialist garage.

 shows.

WARNING

Unusual driving behaviour during emergency operation of the electric drive

Risk of accident

- Avoid accelerating sharply and overtaking.

Consult a specialist workshop, preferably an authorised BMW Motorrad retailer.

High-voltage system cannot be switched on or switched off

 lights up yellow.

 Fault in e-Drive.
Have it checked by a specialist workshop.

Possible cause:

The high-voltage system cannot be switched on or switched off.

- Consult a specialist workshop, preferably an authorised BMW Motorrad retailer.

Fault in electric drive

 lights up yellow.

 Fault in e-Drive.
Limited onward journey possible. Drive carefully to nearest specialist garage.

Consult a specialist workshop, preferably an authorised BMW Motorrad retailer.

Plug locking problem

 lights up yellow.

 Cable lock damaged.
Reconnect the cable.

If this occurs again, contact a specialist workshop.

Possible cause:

Charging cable cannot be unlocked.

- Emergency-unlock the charging plug. (→ 133)

Possible cause:

Charging cable cannot be locked.

- Fully insert the connector into the socket.
- If the fault persists consult a specialist workshop, preferably an authorised BMW Motorrad retailer.

Serious fault in electric drive

flashes red.



Serious fault in e-Drive! Stop immediately! Have it checked by a specialist workshop.

Possible cause:

A serious fault in the electric drive has been detected. Irregular handling can occur. Continuing to ride can lead to damage to the vehicle.

- Stop immediately.
- Consult a specialist workshop, preferably an authorised BMW Motorrad retailer.

Propulsion system too hot

lights up yellow.



Drive system too hot: Power reduced. Limited onward journey possible.

Possible cause:

The coolant level is too low.

- Check the coolant level. (▢▢▢▢ 169)
- If the coolant level is too low:
- Allow the drive and the cooling system to cool down.
 - Topping up coolant (▢▢▢▢ 169).
 - If the problem recurs have the cooling system checked

by a specialist workshop, preferably an authorised BMW Motorrad retailer.

Possible cause:

A high temperature has been detected in the drive or in the cooling system.

- If possible, ride in the part-load range to cool down the drive system.
- If the temperature in the cooling system is frequently too high, have the fault rectified as soon as possible by a specialist workshop, preferably an authorised BMW Motorrad retailer.

Charging system overheated

lights up yellow.



Charging interruption Chrg sys overheated. Check coolant level. If this occurs again, have it checked by a specialist workshop.

Possible cause:

The coolant level is too low.

- Check the coolant level. (▢▢▢▢ 169)
- If the coolant level is too low:
- Allow the drive and the cooling system to cool down.

- Check the charging connection and the electricity supply point; if applicable use a different electricity supply point.

Fault in the charging system



lights up yellow.



Charging system fault. Charging not possible. Drive carefully to the nearest specialist workshop.

Possible cause:

A fault on the vehicle has caused the charging process to abort or the charging process could not be started. The DC/DC transformer is faulty.

- Switch on operational readiness.
- Disconnect the charging cable.
- Wait for 2 minutes.
 - » Vehicle is in sleep mode.
- Switch off operational readiness.
- Connect the charging cable.
 - » Another attempt at charging is started.
- If the fault recurs consult a specialist workshop, preferably an authorised BMW Motorrad retailer.

Possible cause:

If the fault occurs while the vehicle is on the move: The DC/DC transformer is faulty and the 12 V battery cannot be recharged.

- Have the fault rectified as quickly as possible by a specialist workshop, preferably an authorised BMW Motorrad retailer.
 - » It is possible to continue riding until the battery is flat, but this is not recommended.

Condition of onboard electrical system battery (12 V battery)



lights up yellow.



On-board battery status. No restrictions. Have it checked by a specialist workshop.

Possible cause:

The onboard battery can no longer maintain its charge and will have to be replaced as soon as possible.

- Consult a specialist workshop, preferably an authorised BMW Motorrad retailer.

48 STATUS INDICATORS

On-board system voltage low



lights up yellow.



is displayed in yellow.



Vehicle voltage low. Switch off unnecessary consumers.

Possible cause:

Too many consumers are switched on.

- Charge the 12 V battery. (→ 175)

If the 12 V battery no longer charges fully:

- Consult a specialist workshop, preferably an authorised BMW Motorrad retailer.

Voltage of the vehicle electrical system critical



lights up yellow.



is displayed in yellow.



Vehicle voltage critical! Consumers were switched off. Check battery condition. or Battery is not being charged. Check battery status.

The 12 V battery no longer has enough capacity to supply all the consumers.

Possible cause:

Too many consumers are switched on.

- Charge the 12 V battery. (→ 175)

If the 12 V battery no longer charges fully:

- Consult a specialist workshop, preferably an authorised BMW Motorrad retailer.

ASC/DTC intervention



quick-flashes.

Possible cause:

The ASC/DTC has detected a degree of instability at the rear wheel and has intervened to reduce torque.

The indicator and warning light flashes longer than the duration of the ASC/DTC. This affords the rider visual feedback on control intervention even after the critical situation has been dealt with.

- You can continue to ride. Ride carefully and think well ahead.

ASC/DTC restricted



lights up yellow.



shows.



Traction control limited! Onward journey possible. Ride carefully to next specialist workshop.

Possible cause:

The ASC/DTC control unit has detected a fault.

- Bear in mind that the ASC/DTC function is restricted.
- You can continue to ride. Bear in mind the more detailed information on situations that can lead to an ASC/DTC fault (►► 154).
- Have the fault rectified as quickly as possible by a specialist workshop, preferably an authorised BMW Motorrad retailer.

ASC/DTC failed



lights up yellow.



shows.



Traction control systems failed! Limited onward journey possible. Drive carefully to the nearest workshop.

Possible cause:

The ASC/DTC control unit has detected a fault.

- Do not damage the angular rate sensor.
- Bear in mind that the ASC/DTC function is not available or the functionality is subject to certain restrictions.
- You can continue to ride. Bear in mind the more detailed information on situations that can lead to an ASC/DTC fault (►► 154).
- Have the fault rectified as quickly as possible by a specialist workshop, preferably an authorised BMW Motorrad retailer.

Tyre pressure

–with tyre pressure control (RDC)^{OE}

In addition to the MY VEHICLE menu screen and the Check Control messages, there is also the TYRE PRESSURE screen for showing the tyre pressures:

50 STATUS INDICATORS



The values on the left are for the front wheel; those on the right are for the rear wheel. Actual and specified tyre pressures and the difference between them are displayed for each wheel.

Immediately after operational readiness is switched on, only dashes are displayed. The sensors do not start transmitting tyre pressure signals until the first time the vehicle accelerates to more than the minimum speed stated below:



RDC sensor is not active

min 30 km/h (The RDC sensor does not transmit its signal to the vehicle until a certain minimum speed has been reached.)



The tyre pressures are shown in the TFT display as temperature compensated and always refer to the following tyre air temperature:

20 °C



If the tyre symbol appears as well, showing yellow or red, this is a warning. The pressure difference is highlighted with an exclamation point in the same colour.



If the value in question is close to the limit of the permissible tolerance range, the reading is accompanied by the 'General' warning light showing yellow.



The 'General' warning light flashes red if the tyre pressure registered by the sensor is outside the permissible tolerance range.

For further information about the BMW Motorrad RDC, see the section entitled "Engineering details" from page (➡ 158) onward.

Tyre pressure close to limit of permitted tolerance



lights up yellow.



is displayed in yellow.



Tyre pressure does not match setpoint

Check tyre pressure.

Possible cause:

Measured tyre pressure is close to the limit of permitted tolerance.

- Correct tyre pressure.
- Before adjusting tyre pressure, read the information on temperature compensation and adjusting pressure in the section entitled "Engineering details":

–with tyre pressure control (RDC)^{OE}

» Temperature compensation (159)◁

–with tyre pressure control (RDC)^{OE}

» Pressure adaptation (159)◁

» Find the correct tyre pressures in the following places:

–Back cover of the rider's manual

–Instrument cluster in the TYRE PRESSURE view

–Sign on inside of helmet compartment hinged lid

Tyre pressure outside permitted tolerance



flashes red.



is displayed in red.



Tyre pressure does not match setpoint

Stop immediately! Check tyre pressure.



Tyre press. control. Loss of pressure.

Stop immediately! Check tyre pressure.



WARNING

Tyre pressure outside the permitted tolerance.

Risk of accident, degradation of the vehicle's driving characteristics.

- Adapt your style of riding accordingly.

Possible cause:

Measured tyre pressure is outside permitted tolerance.

- Check the tyre for damage and to ascertain whether the vehicle can be ridden with the tyre in its present condition.

52 STATUS INDICATORS

If the vehicle can be ridden with the tyre in its present condition:

- Correct the tyre pressure at the earliest possible opportunity.
- Before adjusting tyre pressure, read the information on temperature compensation and adjusting pressure in the section entitled "Engineering details":
 - with tyre pressure control (RDC)^{OE}
 - » Temperature compensation (▶▶▶ 159)◀
 - with tyre pressure control (RDC)^{OE}
 - » Pressure adaptation (▶▶▶ 159)◀
 - » Find the correct tyre pressures in the following places:
 - Back cover of the rider's manual
 - Instrument cluster in the TYRE PRESSURE view
- Have the tyre checked for damage by a specialist workshop, preferably an authorised BMW Motorrad retailer.

If you are unsure whether the vehicle can be ridden with the tyre in its present condition:

- Do not continue your journey.
- Notify the breakdown service.

Transmission fault



"---"

Possible cause:

The vehicle has not reached the minimum speed (▶▶▶ 158).



RDC sensor is not active

min 30 km/h (The RDC sensor does not transmit its signal to the vehicle until a certain minimum speed has been reached.)

- Increase speed above this threshold and observe the RDC readings.



Assume that a permanent fault has not occurred unless the 'General' warning light comes on to accompany the symptoms.

Under these circumstances:

- Have the fault rectified by a specialist workshop, preferably an authorised BMW Motorrad retailer.

Possible cause:

Wireless communication with the RDC sensors has been disrupted. Radio systems are located in the surrounding area which are interfering with the transmission between the RDC control unit and the sensors.

- Move to another location and observe the RDC readings.

 Assume that a permanent fault has not occurred unless the 'General' warning light comes on to accompany the symptoms.

Under these circumstances:

- Have the fault rectified by a specialist workshop, preferably an authorised BMW Motorrad retailer.

Sensor faulty or system fault

 lights up yellow.

 "----"

Possible cause:

Vehicle is fitted with wheels not equipped with RDC sensors.

- Fit wheels and tyres equipped with RDC sensors.

Possible cause:

1 or 2 RDC sensors have failed or there is a system fault.

- Have the fault rectified by a specialist workshop, preferably an authorised BMW Motorrad retailer.

Battery for tyre pressure sensor weak

 lights up yellow.

 RDC sensor battery weak. Function limited. Have it checked by a specialist workshop.

 This error message shows briefly only after the Pre-Ride-Check completes.

Possible cause:

The integral battery in the tyre-pressure sensor has lost a significant proportion of its original capacity. There is no assurance of how long the tyre pressure monitoring system can remain operational.

- Consult a specialist workshop, preferably an authorised BMW Motorrad retailer.

Tyre pressure monitoring (RDC) failed

—with tyre pressure control (RDC)^{OE}

 lights up yellow.

 Tyre pressure check failure! Function limited. Have it checked by a specialist workshop.

54 STATUS INDICATORS

Possible cause:

The tyre pressure monitor (RDC) control unit has diagnosed a communication fault.

- Consult a specialist workshop, preferably an authorised BMW Motorrad retailer.

» Tyre pressure warnings not available.

Emergency call function restricted

–with intelligent emergency call^{OE}

 lights up yellow.

 Emergency call system restricted. If this occurs again, have the vehicle checked by a specialist workshop.

Possible cause:

The emergency call cannot be made automatically or cannot be made via BMW.

- Consult the information on operating the intelligent emergency call on page  65
- Consult a specialist workshop, preferably an authorised BMW Motorrad retailer.

Emergency call function failed

–with intelligent emergency call^{OE}

 lights up yellow.

 Emergency call system error. Make an appointment at a specialist workshop.

Possible cause:

The control unit of the emergency call system has diagnosed a fault. The emergency call function has failed.

- Bear in mind that an emergency call cannot be made.
- Consult a specialist workshop, preferably an authorised BMW Motorrad retailer.

Side stand monitoring is faulty

 lights up yellow.

 Side stand monitoring faulty. Engine stop at low speed! Have it checked by a specialist workshop.

Possible cause:

The side-stand switch or its wiring are damaged. The electrical machine is shut down when speed drops below 5 km/h and you cannot resume your journey.

- Consult a specialist workshop, preferably an authorised BMW Motorrad retailer.

ABS self-diagnosis not completed



flashes.

Possible cause:



ABS self-diagnosis not completed

The ABS function is not available, because self-diagnosis did not complete. (The E-Scooter has to reach a defined minimum speed for the wheel sensors to be checked: min 5 km/h)

- Pull away slowly. Bear in mind that the ABS function is not available until self-diagnosis has completed.

ABS fault



lights up yellow.



shows.



Limited ABS availability! Onward journey possible. Ride carefully to next specialist workshop.

Possible cause:

The ABS control unit has detected a fault. The ABS function is available, subject to restrictions.

- You can continue to ride. Bear in mind the more detailed information on certain situations that can lead to an ABS fault message (→ 151).
- Have the fault rectified as quickly as possible by a specialist workshop, preferably an authorised BMW Motorrad retailer.

ABS failed



lights up yellow.



shows.



ABS failure! Onward journey possible. Ride carefully to next specialist workshop.

Service due

is displayed in white.

Service due! Have service performed by a specialist workshop.

Possible cause:

Service is due, because of either distance covered or time expired.

- Have your vehicle serviced regularly by a specialist workshop, preferably an authorised BMW Motorrad retailer.
- » The vehicle remains operationally reliable and road-worthy.
- » The vehicle retains its value.

Service-due date has passed

lights up yellow.



is displayed in yellow.

Service overdue! Have service performed by a specialist workshop.

Possible cause:

Service is overdue because of the driving performance or the date.

- Have your vehicle serviced regularly by a specialist workshop, preferably an authorised BMW Motorrad retailer.

» The vehicle remains operationally reliable and road-worthy.

» The vehicle retains its value.

OPERATION

04

OPERATIONAL READINESS	60
EMERGENCY-OFF SWITCH (KILL SWITCH)	64
INTELLIGENT EMERGENCY CALL	65
REVERSING	67
LIGHTING	68
RIDING MODE	73
ANTI-THEFT ALARM (DWA)	75
TYRE PRESSURE MONITORING (RDC)	78
HEATING	78
STORAGE COMPARTMENT	79
HELMET COMPARTMENT	81

60 OPERATION

OPERATIONAL READINESS

Keys

 The telltale light for the radio-operated key flashes while the search for the radio-operated key is in progress. The light goes out as soon as the radio-operated key or the emergency key is found. The light goes out briefly if the search times out without the radio-operated key or the emergency key being found.

You receive one radio-operated key and one spare key. If a key is lost or mislaid, consult the notes on the electronic immobiliser (EWS) (➔ 62).

Operational readiness and anti-theft alarm system work with the radio-operated key. Storage compartment locks and topcase can be locked and unlocked manually.

 The vehicle cannot be started if the radio-operated key is not within range (e.g. key inside one of the cases or the topcase). If the radio-operated key remains out of range operational readiness is switched off after about 1.5 minutes to protect the battery.

It is advisable to keep the radio-operated key on your person (e.g. in a jacket pocket) and to have the emergency key with you as an alternative.

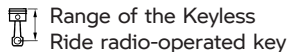

approx. 1 m

Engaging steering lock Requirement

The handlebars are turned towards the left. Radio-operated key is within range.



- Press and hold down button **1**.
 - » The steering lock engages with an audible click.
 - » Operational readiness, lights and all function circuits switched off.
- Short-press button **1** to disengage the steering lock.

Switching on operational readiness

Requirement

Radio-operated key is within range.



- There are **two** ways of switching on operational readiness.

Version 1:

- Short-press button **1**.
 - » Side lights and all function circuits are switched on.
 - with daytime riding light^{OE}
 - » Daytime riding light is switched on.◁
 - » Pre-Ride-Check is performed. (▮▮▮ 138)
 - » ABS self-diagnosis is in progress. (▮▮▮ 139)

Version 2:

- Steering lock is engaged; press and hold down button **1**.
 - » The steering lock disengages.
 - » Side lights and all function circuits switched on.

–with daytime riding light^{OE}

- » Daytime riding light is switched on.◁
- » Pre-Ride-Check is performed. (▮▮▮ 138)
- » ABS self-diagnosis is in progress. (▮▮▮ 139)

Switching off operational readiness

Requirement

Radio-operated key is within range.



- There are **two** ways of switching off operational readiness.

Version 1:

- Short-press button **1**.
 - » Light is switched off.
 - » Handlebars (steering lock) are not locked.

Version 2:

- Turn the handlebars all the way to the left.
- Press and hold down button **1**.

62 OPERATION

- » Light is switched off.
- » The steering lock engages.

Electronic immobiliser EWS

The on-board electronics of the E-Scooter access the data saved in the vehicle key via a ring aerial in the R/C ignition lock. Riding readiness is not enabled until the electronic control unit has recognised the key as "authorised" for your vehicle.

 A second radio-operated key attached to the same ring as the radio-operated key used for starting can "irritate" the electronics, in which case the enabling signal for ride readiness is not issued. Always keep the radio-operated keys separate from each other.

If you lose a key, you can have it barred by your authorised BMW Motorrad retailer. If you wish to do this, you will need to bring all other keys for the E-Scooter with you to the dealership. The electrical machine cannot be started by a barred key, but a key that has been barred can subsequently be reactivated. You can obtain spare keys only through an authorised

BMW Motorrad retailer. The keys are part of an integrated security system, so the retailer is under an obligation to check the legitimacy of all applications for replacement/extra keys.

Battery of the radio-operated key is empty or loss of the radio-operated key

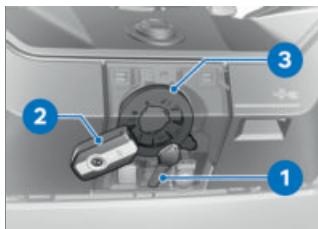

- If a key is lost or mislaid, consult the notes on the electronic immobiliser (**EWS**).
- If you happen to lose or mislay the radio-operated key while on a journey, you can start the vehicle with the spare key.
- If the battery of the radio-operated key is empty, the vehicle can be started by touching the radio-operated key against the cover between the storage compartment lid and the charging compartment lid.

- Hold spare key **1** or radio-operated key with empty battery **2** against the cover between the storage compartment lid and the charging compartment lid at the location of aerial **3**.

	<p>Time within which riding readiness can be established. The unlocking procedure has to be repeated if this time is allowed to expire.</p>
<p>30 s</p>	

- » Pre-Ride-Check is performed.
- Radio-operated key has been recognised.
- Electrical machine can be started.
- Switch on operational readiness. (➡ 61)

Replacing battery of radio-operated key

If the radio-operated key does not react when you short-press or long-press a button:

- Battery of the radio-operated key is not at full capacity.



Remote key battery weak. Function limited. Change battery.

DANGER

Swallowing a battery

Risk of injury or death

- An ignition key contains a button cell as its battery. Batteries or button cells, if swallowed, can cause serious or fatal injury within two hours, for example resulting from internal burns or caustic action.
- Keep ignition keys and batteries out of reach of children.
- If there is any suspicion that a battery or button cell has been swallowed or is inside a part of the body, seek medical assistance immediately.

- Change the battery.

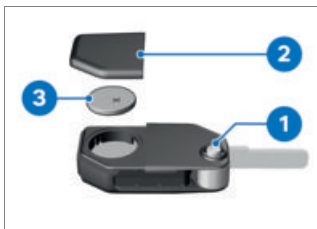

- Press button **1**.
- » Key bit flips out.
- Push battery cover **2** up.

64 OPERATION

- Remove battery **3**.
- Dispose of the old battery in accordance with all applicable laws and regulations; do not attempt to dispose of batteries as domestic waste.



ATTENTION

Unsuitable or incorrectly inserted batteries

Component damage

- Use a battery compliant with the manufacturer's specifications.
 - When inserting the battery, always make sure polarity is correct.
-
- Insert the new battery with the positive terminal up.



Battery type

For Keyless Ride radio-operated key

CR 2032

- Install battery cover **2**.
- » Red LED in the instrument cluster flashes.
- » The radio-operated key is again ready for use.

EMERGENCY-OFF SWITCH (KILL SWITCH)



- 1** Emergency-off switch (kill switch)

Emergency off switch **1** is a kill switch for switching off the electric drive quickly.



- A** Electric drive switched off
B E-Scooter ready to ride

INTELLIGENT EMERGENCY CALL

—with intelligent emergency call^{OE}

Emergency call via BMW

Press the SOS button in an emergency only.

The emergency call is not able to be ensured because of technical reasons due to unfavourable conditions, e.g. in areas where there is no mobile phone reception.

During an emergency call, the location of the vehicle, the choice of language and, if applicable, accident-related data are transmitted to BMW (▮▮▮▮ 12). Under unfavourable conditions, data transfer can be restricted or delayed. This can lead to delayed processing of the emergency call.

Even if an emergency call using BMW is not possible, the system may make an emergency call to a public emergency call number. This depends on the respective mobile phone network and the national regulations.

Language for emergency call

Each vehicle has a language assigned to it depending on the market for which it is intended. The BMW Call Center answers in this language.

 The language for the emergency call can only be changed by the BMW Motorrad partner. The language assigned to the vehicle differs from the display languages that can be selected by the rider in the TFT display.

Manual emergency call Requirement

An emergency has occurred. The vehicle is at a standstill. Operational readiness is switched on.



- Open cover **1**.
- Short-press SOS button **2**.

66 OPERATION

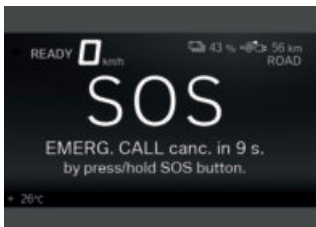

The time until transmission of the emergency call is displayed. During that time, it is possible to cancel the emergency call.

- To cancel an emergency call: Press SOS button **2** and hold it down for two seconds.
 - Operate the emergency-off switch to switch off riding readiness.
 - Remove helmet.
- » After expiry of the timer, a voice contact to the BMW Call Center is established.

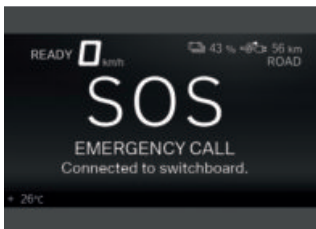

The connection was established.



- Provide information to the emergency services using the microphone **3** and speaker **4**.

Automatic

When you switch on operational readiness, the intelligent emergency call function is automatically active and reacts if a fall or a crash occurs.

Emergency call in the event of a light fall

- A minor fall or a crash is detected.
- » An acoustic signal is sounded.

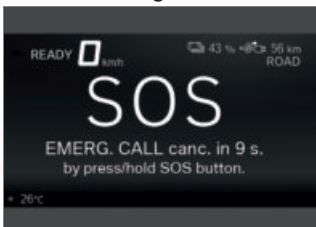

The time until transmission of the emergency call is displayed.

During that time, it is possible to cancel the emergency call.

- To cancel an emergency call: Press the SOS button and hold it down for two seconds.
 - If possible, remove your helmet and switch off the electrical machine.
- » A voice contact connection to the BMW Call Center is established.

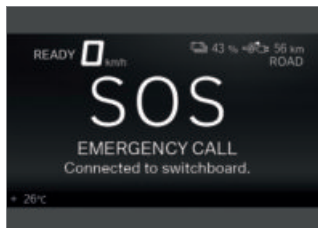

The connection was established.



- Open cover **1**.
- Provide information to the emergency services using the microphone **3** and speaker **4**.

Emergency call in the event of a severe fall

- A severe fall or a crash is detected.
- » The emergency call is placed automatically without delay.

REVERSING

Operating reversing function



WARNING

Less perceptibility of electric propulsion.

Risk of accident

- When you use electric propulsion, you must always bear in mind that the absence of engine noise means that pedestrians and other road users might not be aware of your approach on your E-Scooter.
 - Exercise special care and attention when riding.
- Switch on riding readiness. (→ 141)

68 OPERATION



- Keep button **1** pressed down throughout the reversing manoeuvre.



- Arrow symbol **1** shows while the reversing manoeuvre is in progress.

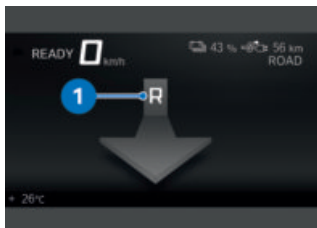

- Enabling is indicated in the display by an R accompanied by an arrow down symbol **1**.
 - Gently turn the electronic throttle grip and reverse the vehicle.
- » The E-Scooter reverses at no more than 3 km/h.

LIGHTING

Low-beam headlight and sidelights

The side lights switch on automatically as soon as the E-Scooter is ready for operation. The side lights then remain on for a short time.

The low-beam headlight switches on automatically as soon as the E-Scooter is ready to ride.

—with daytime riding light^{OE}
In daytime the daytime riding light can be switched on as an alternative to the low-beam headlight.

High-beam headlight and headlight flasher

- Switch on operational readiness. (▶▶▶ 61)



- Push switch **1** forward to switch on the high-beam headlight.
- Pull switch **1** back to operate the headlight flasher.

Headlight courtesy delay feature

- Switch off operational readiness.



- Immediately after switching off operational readiness, pull switch **1** back and hold it in that position until the head-

light courtesy delay feature switches on.

- » The vehicle's lights come on for one minute and then switch off automatically.
- This can be used to light up the path to the house door after the vehicle has been parked, for example.

Parking lights

- Switch off operational readiness. (▶▶▶ 61)



- Immediately after switching off operational readiness, push button **1** to the left and hold it in that position until the parking lights come on.
- Switch operational readiness on and off again to switch off the parking lights.

70 OPERATION

Using daytime riding light —with daytime riding light^{OE}

- Switch on riding readiness.
( 141)



- Press button **1** to switch on the daytime riding light and switch off the low-beam headlight.

 The daytime riding lights symbol is displayed.

- In the dark or in a tunnel:
Press button **1** again to switch off the daytime riding light and switch on the low-beam headlight.

 By comparison with the low-beam headlight, the daytime running light makes the vehicle more visible to on-coming traffic. This improves daytime visibility.

Automatic daytime riding light —with daytime riding light^{OE}

 The changeover between daytime riding light and low-beam headlight including side lights can be set to automatic.

WARNING

The automatic daytime riding light is not a substitute for the rider's personal judgement of the light conditions

Risk of accident

- Switch off the automatic daytime riding light in poor light conditions.

- Navigate to *Settings*, *Vehicle settings*, *Lights* and switch on the *Auto. daytime light* function.

 The indicator light for the automatic daytime riding light shows.

- » If ambient brightness drops below a certain value, the low-beam headlight is automatically switched on (e.g. in a tunnel). When sufficient ambient brightness is detected,

ted, the daytime riding light is switched back on.



The indicator light for the daytime riding light shows if the daytime riding light is active.

Manual operation of the light when the automatic system is switched on

—with daytime riding light^{OE}

If you press the button for the daytime riding light, the daytime riding light is switched off and the low-beam headlight and front side lights are switched on (e. g. when you ride into a tunnel, and the response of the automatic daytime riding light to the change in ambient brightness is delayed).

If you press the button again the daytime riding light is re-activated, in other words the daytime riding light is switched on again when ambient light is bright enough.

Automatic daytime riding light

—with daytime riding light^{OE}



The changeover between daytime riding light and low-beam headlight including side lights can be set to automatic.



WARNING

The automatic daytime riding light is not a substitute for the rider's personal judgement of the light conditions

Risk of accident

- Switch off the automatic daytime riding light in poor light conditions.

- Navigate to *Settings*, *Vehicle settings*, *Lights* and switch on the *Auto. daytime light* function.



The indicator light for the automatic daytime riding light shows.

- » If ambient brightness drops below a certain value, the low-beam headlight is automatically switched on (e.g. in a tunnel). When sufficient ambient brightness is detected, the daytime riding light is switched back on.



The indicator light for the daytime riding light shows if the daytime riding light is active.

72 OPERATION

Automatic daytime riding light

—with daytime riding light^{OE}

 The changeover between daytime riding light and low-beam headlight including side lights can be set to automatic.



WARNING

The automatic daytime riding light is not a substitute for the rider's personal judgement of the light conditions

Risk of accident

- Switch off the automatic daytime riding light in poor light conditions.
 - Navigate to *Settings*, *Vehicle settings*, *Lights* and switch on the *Auto. daytime light* function.
-  The indicator light for the automatic daytime riding light shows.
- » If ambient brightness drops below a certain value, the low-beam headlight is automatically switched on (e.g. in a tunnel). When sufficient ambient brightness is detected,

the daytime riding light is switched back on.



The indicator light for the daytime riding light shows if the daytime riding light is active.

Operating hazard warning flashers

- Switch on operational readiness. (→ 61)



The hazard warning flashers place a strain on the battery. Do not use the hazard warning flashers for longer than absolutely necessary.



If you press a turn-indicator button while the hazard warning lights are switched on, the turn-indicator function is activated instead of the hazard warning flashers and remains active until you release the button. The hazard warning flashers recommence flashing as soon as the button is released.



- Press button **1** to switch on the hazard warning flashers.
- » Operational readiness can be switched off.
- Switch on operational readiness and press button **1** again to switch off the hazard warning flashers.

Operate the turn indicators

- Switch on operational readiness. (▶▶▶ 61)
- Navigate to Settings, Vehicle settings, Lights.
- Switch Comfort turn indicator on or off.



- Push button **1** to the left to switch on the left turn indicators.
- Push button **1** to the right to switch on the right turn indicators.
- Press button **1** to cancel the turn indicators.
- » If the comfort turn indicators function is activated, the turn indicators are cancelled automatically when the speed-dependent distance is covered.

RIDING MODE

Using riding modes

BMW Motorrad has developed operational scenarios for your E-Scooter from which you can select the scenario suitable for your situation:

- ECO: range-optimised riding.
- RAIN: riding on rain-wet roads.
- ROAD: riding on dry roads.

74 OPERATION

- with riding modes Pro^{OE}
- DYNAMIC: dynamic riding on dry roads.

The respective optimum interplay of electrical machine characteristic, ASC/DTC control and energy recovery stability control (RSC) is provided for each of these scenarios.

Setting riding mode

- Switch on operational readiness. (▶▶▶ 61)



- Press button **1**.

 See the section entitled "Engineering details" for more information on the selectable riding modes.

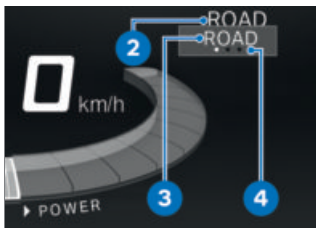

The riding mode currently active **2** is sent to the back and the first selectable riding mode **3** is displayed. The guide **4** indicates how many riding modes are available.



- Repeatedly press button **1** until the riding mode you want appears beside the selection arrow.
- » The selected riding mode is activated after approximately 2 seconds.

ANTI-THEFT ALARM (DWA)

–with anti-theft alarm (DWA)^{OE}

Activation

- Switch on operational readiness. (▶▶▶ 61)
- Customise the anti-theft alarm settings. (▶▶▶ 77)



- Switch off operational readiness.
- Press button **1** on the radio-operated key twice.
 - » Activation takes approximately 30 seconds to complete.
 - » Turn indicators flash twice.
 - » Confirmation tone sounds twice (if programmed).
 - » Anti-theft alarm is active.



- To deactivate the tilt sensor (for example if you are about to transport the E-Scooter on a train and the swaying movement of the moving train could trip the alarm), press button **1** on the radio-operated key again during the activation phase.
 - » Turn indicators flash three times.
 - » Confirmation tone sounds three times (if programmed).
 - » Tilt sensor is deactivated.

Alarm signal

A DWA alarm can be triggered by:

- Tilt sensor
- Switch-on attempt with an unauthorised vehicle key.
- Disconnection of the DWA anti-theft alarm from the vehicle's battery (DWA internal battery in the anti-theft alarm provides power -

76 OPERATION

acoustic alarm only, the turn indicators do not flash)

 When the radio-operated key is within range, an alarm triggered by the tilt sensor is suppressed.

All functions are sustained even if the internal battery of the DWA anti-theft alarm system is flat; the only difference is that an alarm cannot be triggered if the system is disconnected from the vehicle's battery.

An alarm lasts for approximately 26 seconds. While an alarm is in progress an alarm tone sounds and the turn indicators flash. The type of acoustic alarm tone can be set by an authorised BMW Motorrad retailer.



You can cancel an alarm at any time by pressing button **1** on the radio-operated key; this does not deactivate the alarm system.

If an alarm was triggered while the vehicle was unattended, the rider is notified accordingly by an alarm tone sounding once when operational readiness is switched on. The DWA LED then indicates the reason for the alarm for one minute.

Light signals issued by the indicator light:

- Flashes 1x: Tilt sensor 1
- Flashes 2x: Tilt sensor 2
- Flashes 3x: Operational readiness switched on with unauthorised key
- Flashes 4x: Disconnection of the anti-theft alarm from the vehicle's battery
- Flashes 5x: Tilt sensor 3

Deactivation

Version 1:

- Kill switch in operating position (run).
- Switch on operational readiness. (▣▣▣ 61)
 - » Turn indicators flash once.
 - » Confirmation tone sounds once (if programmed).
 - » DWA has been switched off.

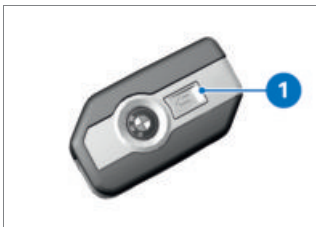

Version 2:

- Press button 1 on the radio-operated key once.
- i** If the alarm function is deactivated by the radio-operated key and operational readiness is not subsequently switched on, the alarm function is automatically reactivated after approx. 30 seconds if Arm automatically is switched on.
- » Turn indicators flash once.
 - » Confirmation tone sounds once (if programmed).
 - » DWA has been switched off.

Customise the anti-theft alarm settings

- Switch on operational readiness. (▣▣▣ 61)
- Navigate to Settings, Vehicle settings, Alarm system.
 - » The following settings are available:
 - Adapting Warning signal
 - Switch Tilt sensor on or off
 - Switch Arming tone on or off
 - Switch Arm automatically on or off
 - » Possibilities for adjustment (▣▣▣ 77)

Possibilities for adjustment

Warning signal: Set the rising and falling or intermittent alarm tone.

Tilt sensor: Activate tilt sensor to monitor the inclination of the vehicle. The anti-theft alarm is tripped if any attempt is made to steal a wheel or lift the vehicle for towing, for example.

i When the vehicle is going to be transported, deactivate the tilt sensor to prevent the anti-theft alarm (DWA) from being triggered.

78 OPERATION

Arming tone: Confirmation alarm tone after activation/deactivation of the anti-theft alarm (DWA) in addition to visual confirmation by turn indicators flashing.

Arm automatically: Automatic activation of the alarm function after operational readiness is switched off.

TYRE PRESSURE MONITORING (RDC)

—with tyre pressure control (RDC)^{OE}

Switch the target-pressure warning on or off

- The system can be set to issue a target-pressure warning if tyre pressure drops to the defined minimum.
- Navigate to **Settings**, **Vehicle settings**, **RDC**.
- Switch **Target pressure warn.** on or off.

HEATING

Operating heated handlebar grips

—with heated grips^{OE}
—without seat heating^{OE}

 The heating in the heated handlebar grips can be activated only when the ride-ready state is switched on.

- Switch on riding readiness. (→ 141)



- Repeatedly press button **1** until desired heating stage **2** appears in front of heated grip symbol **3**.

The handlebar grips have three-stage heating:

 Low heating power

 Medium heating power

 High heating power

- » The high stage is for heating the grips quickly: it is advisable to switch back to stage 1 as soon as the grips are warm.
- » The selected heating stage will be saved if you allow a certain length of time to pass without making further changes.
- To switch off the heated grips, repeatedly press

button **1** until heated grip symbol **3** disappears.

Operate the heating

–with heated grips^{OE}

–with seat heating^{OE}

 The heating in the heated handlebar grips and the seat heating can be activated only when the ride-ready state is switched on.

- Switch on riding readiness.
( 141)



- Press button **1**.
» HEATING menu opens.
- Select Grip heating or Seat heating.
- Select the desired heating stage and confirm your choice.
» The selected heating stage appears on the left beside heating symbol **2**.
- Press button **1** to close the HEATING menu.

- To switch the heating off, or on again with the heating stage selected beforehand, long-press button **1**.

 The selected heating-stage settings are retained in memory when operational readiness is switched off.

STORAGE COMPARTMENT

Opening and closing storage compartment

Requirement

Operational readiness switched on.

ATTENTION

High temperatures in the storage compartments, particularly in summer

Damage to objects stowed away, particularly electronic devices, such as mobile phones

- In summer, do not place heat-sensitive items in the storage compartment.
- Ask the manufacturer about possible usage restrictions and comply with the information provided.

80 OPERATION

ATTENTION

Vibrations when vehicle is moving

Damage to mobile phones carried on the vehicle

- Make sure that the mobile phone carried on the vehicle is suitable for use on the motorcycle. Ask the manufacturer about related usage restrictions and comply with the information provided.



- Open storage compartment lid **1** by pressing button **2**.
 - » When opened, the storage compartment hinged lid is not suitable for placing objects on.
- To close: Firmly press storage compartment lid **1** into the lock.

Ventilation

To ensure adequate circulation of air, a fan is switched on if the temperature in the storage compartment rises above 35 °C. The fan switches off again as soon as the temperature inside the storage compartment is less than 30 °C.

Charging smartphone Requirement

Operational readiness switched on.

- Open the storage compartment.



- Lay smartphone **2**, display up, in tray **1**.
 - » The smartphone is secured.



- Connect one end of the charging cable to smartphone **2** and USB-C port **3**.

 BMW Motorrad recommends using the BMW Motorrad USB cable for charging smartphones inside the storage compartment. Another commercially available charging cable might not have sufficient space in the storage compartment and could suffer damage.



- Close storage compartment lid **4**.

Notes on use

The storage compartment is suitable for smartphones up to max. 158 mm x 78 mm x 10 mm in size. For small mobile phones that might not be held securely by the holder, BMW Motorrad recommends using the BMW Motorrad smartphone pouch.

Charge current

This is a 5 V USB-C charging interface that provides a maximum charge current of 1.5 A (maximum charging power 7.5 W).

HELMET COMPARTMENT

Opening and closing helmet compartment

- Switch on operational readiness.

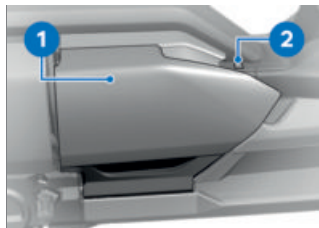

- Open helmet compartment hinged lid **1** by means of button **2**.

82 OPERATION

 The light in the stowage compartment comes on when operational readiness is switched on.

After operational readiness is switched off, the stowage compartment light remains on for a short time.



Payload of the helmet compartment

max 8 kg

» When opened, the helmet compartment hinged lid is not suitable for placing objects on.

• To close: Applying firm pressure midway between the locks, press helmet compartment hinged lid **1** into the locks.

» Both lock hooks of the helmet compartment hinged lid engage with an audible click.

Emergency unlocking of helmet compartment

• Remove the side panel.
( 173)

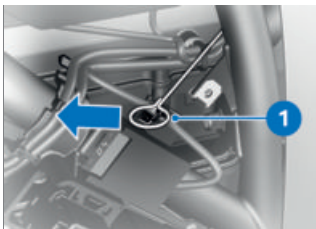

• Using the tool from the on-board toolkit if necessary, pull tab **1** in the direction indicated by the arrow.

» Helmet compartment unlocked.

• Install the side panel.
( 173)

TFT DISPLAY

05

GENERAL NOTES	86
PRINCIPLE	87
PURE RIDE VIEW	93
PURE VIEW	94
SPLITSCREEN	94
GENERAL SETTINGS	95
BLUETOOTH	97
WIFI	99
MY VEHICLE	100
ON-BOARD COMPUTER	103
NAVIGATION	104
MEDIA	106
TELEPHONE	107
DISPLAY SOFTWARE VERSION	108
DISPLAY LICENCE INFORMATION	108

GENERAL NOTES

Warnings



WARNING

Operation of a smartphone while riding the vehicle

Risk of accident

- Always comply with the road traffic regulations in force where you are riding.
- Do not use a smartphone while riding. This applies with the exception of applications without operation, such as hands-free telephony.



WARNING

Distraction from the road and loss of control

Operating the integrated information system and communication devices while driving results in a risk of accident

- Operate those systems or devices only when the traffic situation allows for it.
- If necessary, stop and operate the systems or devices when stationary.

Connectivity functions

Connectivity functions include media, telephony and navigation. Connectivity functions can be used when the TFT display is connected to a mobile device and a helmet (► 97). For more information on the Connectivity functions go to: **bmw-motorrad.com/connectivity**



Depending on the mobile device, the scope of the Connectivity functions may be restricted.

BMW Motorrad Connected app

The BMW Motorrad Connected app enables the user to call up usage data and vehicle status information. For some functions such as navigation, for example, the app has to be installed on the mobile device and paired to the TFT display. The app is used to start route guidance and adjust the navigation.



On some mobile devices, e.g. those with iOS operating systems, the BMW Motorrad Connected App must be opened before use.

Currency

Updates of the TFT display subsequent to the date of publication are possible. Because of this, your vehicle may differ from the information supplied in the rider's manual. Up-to-date information is available at bmw-motorrad.com/service.

PRINCIPLE

Controls

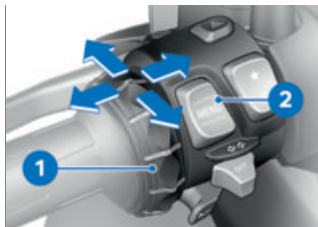

All display content is controlled by means of Multi-Controller **1** and MENU rocker button **2**. Depending on the context, the following functions are possible.

Functions of the Multi-Controller

Turn the Multi-Controller up:

- Move the cursor up in lists.
- Adjust settings.
- Increase volume.

Turn the Multi-Controller down:

- Move the cursor down in lists.
- Adjust settings.
- Decrease volume.

Tilt the Multi-Controller to the left:

- Activate the function in accordance with the operation feedback.
- Activate the function to the left or back.
- Go back to the Menu view after making the settings.
- In Menu view: Change up one level.
- In the *My vehicle* menu: Advance one menu screen.
- In Pure Ride view: Return to the previous splitscreen display.

Tilt the Multi-Controller to the right:

- Activate the function in accordance with the operation feedback.
- Confirm selection.
- Confirm settings.
- Advance a menu step.
- Scroll to the right in lists.
- In the *My vehicle* menu: Advance one menu screen.
- In Pure Ride view: Advance to the next splitscreen display.

88 TFT DISPLAY

MENU rocker button functions

 Instructions given by the navigation system are displayed in a dialogue box if the Navigation menu has not been called up. Operation of the MENU rocker button is temporarily restricted.

Short-press the top section of the MENU button:

- In Menu view: Change up one level.
- In Pure (Ride) view: Change the display for the status line.

Long-press the top section of the MENU button:

- In Menu view: Open the Pure Ride view.

Short-press the bottom section of the MENU button:

- Change down a level.
- No function if the lowest hierarchical level has been reached.

Long-press the bottom section of the MENU button:

- Change back to the last menu after a previous menu change effected by long-pressing the top section of the MENU rocker button.

Operating pointers in the main menu

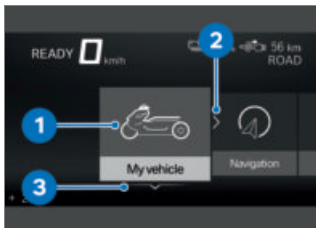

Operating pointers show whether interactions are possible, and which ones.

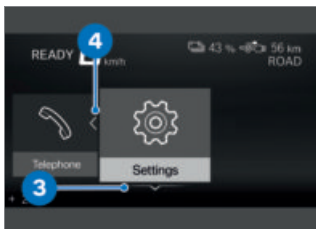

Meaning of the operating pointers:

- Operating pointer 1: Left end reached.
- Operating pointer 2: You can scroll to the right.
- Operating pointer 3: You can scroll down.
- Operating pointer 4: You can scroll to the left.

Operating pointers in submenus

In addition to the operating pointers in the main menu, there are additional operating pointers in the submenus.

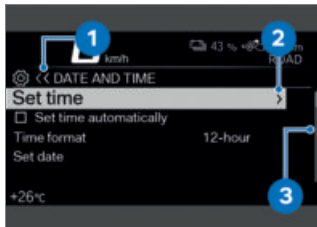

Meaning of the operating pointers:

- Operating pointer **1**: The current display is in a hierarchical menu. One symbol represents one submenu level. Two symbols represent two or more submenu levels. The colour of the symbol changes, depending on whether you can return to a higher level.
- Operating pointer **2**: One more submenu level can be accessed.
- Operating pointer **3**: There are more entries than can be displayed.

Switching functions on and off

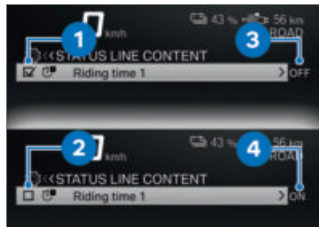

Some menu items have a check box in front of them. The check box shows whether the function is on or off. Action symbols after the menu items indicate what action you can trigger by short-tilting the Multi-Controller to the right.

Examples for switching on and off:

- Symbol **1** shows that the function is switched on.
- Symbol **2** shows that the function is switched off.
- Symbol **3** shows that the function can be switched off.
- Symbol **4** shows that the function can be switched on.

Display Pure (Ride) view

- Long-press the top section of the MENU rocker button.

90 TFT DISPLAY

Calling up menu

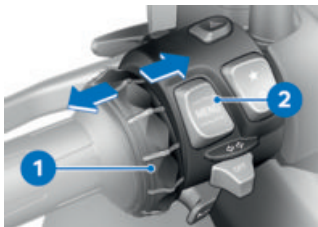

- Display the Pure (Ride) view. (→ 89)
- Short-press the bottom section of button **2**.

The following menus can be called up:

- My vehicle
- Navigation
- Media
- Telephone
- Settings

- Repeatedly short-push Multi-Controller **1** to the right until the menu item you want is highlighted.
- Short-press the bottom section of button **2**.

 The Settings menu can only be called up when the vehicle is stationary.

Moving cursor in lists

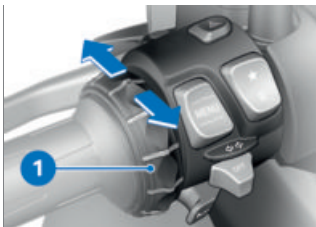

- Call up a menu. (→ 90)
- To move the cursor down in a list, turn Multi-Controller **1** down until the entry you want is highlighted.
- To move the cursor up in a list, turn Multi-Controller **1** up until the entry you want is highlighted.

Confirming selection

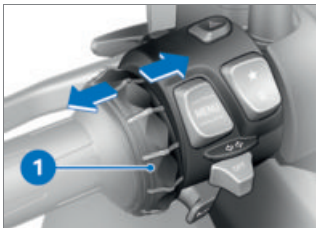

- Select the desired entry.
- Short-push Multi-Controller **1** to the right.

Call up the last menu used

- In Pure Ride view: Long-press the bottom section of the MENU rocker button.
- » The last menu used is called up. The last entry highlighted is selected.

Change the display for the status line

Requirement









The vehicle is at a standstill. The Pure (Ride) view is displayed.

- Switch on operational readiness. (▮▮▮ 61)
- » The TFT display shows all the information necessary for riding on public roads from the on-board computer (e.g. TRIP 1) and the trip computer (e.g. TRIP 2). The information can be displayed in the top status line.
 - with tyre pressure control (RDC)^{OE}
 - » Information from the tyre pressure monitoring can also be displayed. ◀
- Select the content of the top status line. (▮▮▮ 92)



- Long-press button 1 to obtain the Pure Ride view.
- Repeatedly short-press button 1 to select the value in the top status line 2.

The following values can be displayed:

-  Total distance
-  Current distance 1
-  Current distance 2
-  Consumption 1 (Average)
-  Consumption 2 (Average)
-  Recuper. 1
-  Recuper. 2
-  Riding time 1

92 TFT DISPLAY

 Riding time 2

 Break 1

 Break 2

 Speed 1 (Average)

 Speed 2 (Average)

—with tyre pressure control (RDC)^{OE}

 Tyre pressure <

Select the content of the top status line

- Navigate to Settings, Display, Status line content.
- Switch on the desired displays.
- » You can switch between the selected displays in the top status line. If no displays are selected, only the battery state of charge and the range are displayed:

 Battery charge state

 Range

Adjusting settings

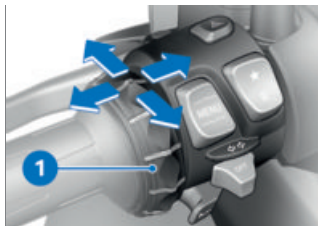

- Select and confirm the desired settings menu.
- Turn Multi-Controller **1** down until the setting you want is highlighted.
- If an operating pointer shows, tilt Multi-Controller **1** to the right.
- If no operating pointer shows, tilt Multi-Controller **1** to the left.
- » The setting is saved.

Switch Speed Limit Info on or off

Requirement

Vehicle is connected to a compatible mobile device. The BMW Motorrad Connected app is installed on the mobile device.

- Speed Limit Info shows the maximum speed permitted at the time, if this information is made available by the

publisher of the map material in the navigation system.

- Navigate to Settings, Display.
- Switch Speed Limit Info on or off.

Favourites buttons



- Navigate to Settings, System settings, Favorite button, Star.
 - Select the desired function or Not assigned.
- » The function you have selected will be called up whenever you press button **1**.

PURE RIDE VIEW

Drive gauge



- 1** Range, energy recovery moment
- 2** Current energy recovery or drive moment
- 3** Range, drive moment

Restrictions



Mark **1** indicates that energy recovery is restricted.

Mark **4** indicates that power is restricted.

In relation to restrictions, the following symbols can show at the top right in the display:
 Symbol **2**: Energy recovery is severely restricted.

94 TFT DISPLAY

Symbol **3**: Power is severely restricted.

Restrictions can be due to different causes. The cause of the restriction is indicated by the colour of mark **1** or **4**:

– Grey: Restriction due to the selected riding mode

– Yellow: System restrictions, due for example to temperature, battery state of charge, steady-state load or system fault.

 The temporary restriction of available power when steady-state load is excessive prevents premature ageing of the battery.

Range and battery state of charge



Range readout **2** indicates how far you can ride with the current battery state of charge **1**.

PURE VIEW

Display

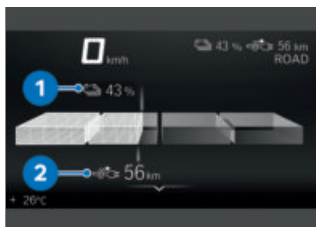

When the vehicle is not riding-ready, instead of the Pure Ride view the Pure view appears in the display.

Battery state of charge **1** and range **2** are displayed.

SPLITSCREEN

Switching on splitscreen view and selecting display

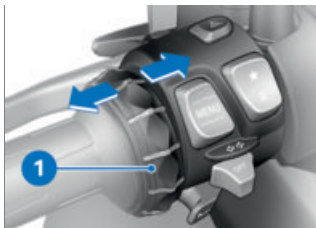

- Display the Pure (Ride) view. (▶▶▶ 89)
- Repeatedly short-push Multi-Controller **1** to the right or left until the display you want appears.

- Alternatively: Long push Multi-Controller **1** to the right to return to the display last selected in splitscreen view.

The following displays can be selected:

- ON-BOARD COMPUTER
- TRIP COMPUTER
- Navigation
- MEDIA

- » The display you select is retained in memory, even after operational readiness is switched off.

Switching off splitscreen

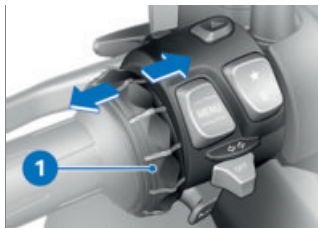

- Display the Pure (Ride) view. (▣▣▣ 89)
- Repeatedly push Multi-Controller **1** to the left until the splitscreen view is switched off.
- Alternatively: Long-push Multi-Controller **1** to the left.

GENERAL SETTINGS

Adjusting volume

- Connect the rider's and passenger's helmets. (▣▣▣ 98)
- Increase volume: Turn the Multi-Controller up.
- Reduce volume: Turn the Multi-Controller down.
- Mute: Turn the Multi-Controller all the way down.
- » Muting pauses media playback.

Set the date

- Switch on operational readiness. (▣▣▣ 61)
- Navigate to Settings, System settings, Date and time, Set date.
- Set Day, Month and Year.
- Confirm setting.

Set date format

- Navigate to Settings, System settings, Date and time, Date format.
- Select the desired setting.
- Confirm setting.

Set the clock

- Switch on operational readiness. (▣▣▣ 61)
- Navigate to Settings, System settings, Date and time, Set time.
- Set Hour and Minute.

96 TFT DISPLAY

Set the time format

- Navigate to Settings, System settings, Date and time, Time format.
- Select the desired setting.
- Confirm setting.

Set units of measurement

- Navigate to Settings, System settings, Units.
- The following units of measurement can be set:
- with tyre pressure control (RDC)^{OE}
 - Pressure◁
 - Temperature
 - Speed
 - Consumption

Set the language

- Navigate to Settings, System settings, Language.
- The following languages can be set:
- German
 - English (UK)
 - English (US)
 - Spanish
 - French
 - Italian
 - Dutch
 - Polish
 - Portuguese (Brazil)
 - Portuguese (Portugal)
 - Turkish
 - Russian

- Ukrainian
- Chinese
- Japanese
- Korean
- Thai
- Romanian

Adjusting brightness

- Navigate to Settings, Display, Brightness.
 - Adjust display brightness.
- » When ambient brightness drops below a defined threshold, the display is dimmed to the brightness set here.

Reset all settings

- All the settings in the Settings menu can be reset to the factory settings.
- Call up the Settings menu.
- Select Reset all and confirm.

The settings in the following menus are reset:

- Vehicle settings
- System settings
- Connections
- Display
- Information

- » Existing Bluetooth connections are not deleted.

BLUETOOTH

Short-range wireless technology

Bluetooth is a short-range wireless technology. Bluetooth devices are short-range devices transmitting on the license-free ISM band (Industrial, Scientific, Medical) between 2.402...2.480 GHz. They can be operated anywhere in the world without a licence being required.

Although Bluetooth is designed to establish and sustain robust connections over short distances, as with every other wireless technology disruptions are possible. Interference can affect connections or connections can sometimes fail. Particularly when multiple devices operate in a Bluetooth network, with wireless technology of this nature it is not possible to ensure fault-free communications in every situation.

Possible sources of interference:

- Interference zones due to transmission masts and similar.
- Devices with non-compliant Bluetooth implementations.

- Proximity of other Bluetooth-compatible devices.
- Shielding by metal objects or bodies.

Pairing

Two Bluetooth devices have to recognise each other before they can communicate. This process of mutual recognition is known as pairing. When two devices have paired they remember each other, so the pairing process is conducted only once, on initial contact.

 On some mobile devices, e.g. those with iOS operating systems, the BMW Motorrad Connected App must be opened before use.

During the pairing process, the TFT display searches for other Bluetooth-compatible devices within its reception range. The conditions that have to be satisfied before the audio system can recognise another device are as follows:

- The device's Bluetooth function must be active
- The device must be "visible" to others
- Other Bluetooth-compatible devices must be OFF (e.g.

98 TFT DISPLAY

mobile phones and navigation systems).

Please consult the operating instructions for your communication system.

Pairing

- Navigate to `Settings, Connections`.

- » Bluetooth connections can be established, managed and deleted in the `CONNECTIONS` menu. The following Bluetooth connections are displayed:

- Mobile device
- Rider's helmet
- Passenger helm.

The connection status for mobile devices is displayed.

Connect mobile device

- Perform pairing. (▶▶▶ 98)
- Activate the mobile device's Bluetooth function (see mobile device's operating instructions).
- Select `Mobile device` and confirm.
- Select `Pair new mobile device` and confirm.

Mobile devices are being searched for.

 flashes in the bottom status line during pairing.

Mobile devices found are displayed.

- Select and confirm mobile device.
- Follow the instructions on the mobile device.
- Confirm that the code matches.
- » The connection is established and the connection status updated.
- » If the connection is not established, consult the troubleshooting chart. (▶▶▶ 200)
- » Depending on the mobile device, telephone data is transferred to the vehicle automatically.
- » Telephone data (▶▶▶ 108)
- » If the phonebook is not displayed, consult the troubleshooting chart. (▶▶▶ 201)
- » If the Bluetooth connection does not work as expected, consult the troubleshooting chart. (▶▶▶ 201)

Connect rider's and passenger's helmet

- Perform pairing. (▶▶▶ 98)
- Select `Rider's helmet` or `Passenger helm.` and confirm.

- Make the helmet's communication system visible.
- Select `Pair new rider's helmet` or `Pair new passenger helmet` and confirm. Helmets are searched for.



flashes in the bottom status line during pairing.

Helmets found are displayed.

- Select and confirm helmet.
 - » The connection is established and the connection status updated.
 - » If the connection is not established, consult the troubleshooting chart. (▣▣▣▣▶ 200)
 - » If the Bluetooth connection does not work as expected, consult the troubleshooting chart. (▣▣▣▣▶ 201)

Delete connections

- Navigate to `Settings, Connections`.
- Select `Delete connections`.
- To delete an individual connection, select the connection and confirm.
- To delete all connections, select `Delete all connections` and confirm.

WiFi

WiFi connection

A WiFi connection is used to transmit the map view from a mobile phone to the TFT display. WiFi has to be activated on the mobile phone in order for the full scope of this functionality to be used. For more information on activating WiFi see the operating instructions for the mobile phone.

Depending on the specifics of the local situation, for example in the presence of numerous wifi networks, temporary restrictions and loss of connection are possible.

100 TFT DISPLAY

MY VEHICLE START SCREEN



- 1 Check Control display
Mode of presentation
(⇒ 30)
- 2 Status, temperature of
coolant (⇒ 45)
- 3 Range (⇒ 94)
- 4 Odometer
- 5 Service display (⇒ 56)
- 6 Tyre pressure, rear
(⇒ 49)
- 7 Status, temperature of
high-voltage battery
- 8 Tyre pressure, front
(⇒ 49)

Operating pointers

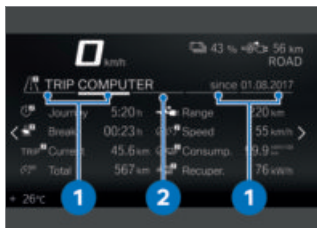

- Operating pointer 1: Indicators showing how far you can scroll to the left or right.
- Operating pointer 2: Indicator showing the position of the current menu screen.

Scrolling through menu screens

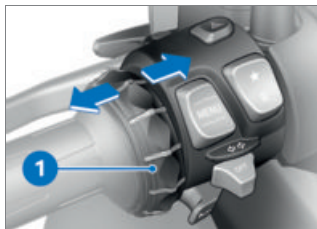

- Call up the My vehicle menu.
- To scroll to the right, short-press Multi-Controller 1 to the right.

- To scroll to the left, short-press Multi-Controller 1 to the left.

The My vehicle menu contains the following screens:

- MY VEHICLE
- ON-BOARD COMPUTER
- TRIP COMPUTER
- with tyre pressure control (RDC)^{OE}
- TYRE PRESSURE <
- SERVICE REQUIREMENTS
- CC MESSAGE (if available)
- For more information on tyre pressures and Check Control messages, see the "Displays" section.

 Check Control messages are attached dynamically to the menu screens as additional tabs in the My vehicle menu.

On-board computer and trip computer

The ON-BOARD COMPUTER and TRIP COMPUTER menu screens display vehicle and trip data, such as average values.

102 TFT DISPLAY

Service requirements

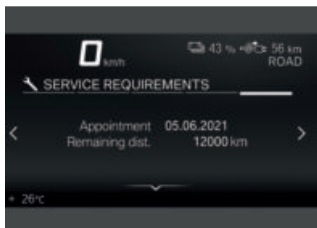

When the next service is due within less than a month or within 1000 km, a white Check Control message is displayed.

ON-BOARD COMPUTER

Call up the on-board computer

- Call up the `My vehicle` menu.
- Scroll to the right until the `ON-BOARD COMPUTER` menu screen is displayed.
 - » Alternatively, the on-board computer can also be shown on the splitscreen.
- Switch on splitscreen view and select display. (►► 94)

Reset the on-board computer

- Call up the on-board computer. (►► 103)
- Press down the `MENU` rocker button.
- Select `Reset all values` or `Reset individual values` and confirm.

The following values can be reset:



Journey



Current



Speed



Consump.



Recuper. 1

Call up the trip computer

- Call up the on-board computer. (►► 103)
- Scroll to the right until the `TRIP COMPUTER` menu screen is displayed.
 - » Alternatively, the trip computer can also be shown on the splitscreen.
- Switch on splitscreen view and select display. (►► 94)

Reset the trip computer

- Call up the trip computer. (►► 103)
- Press down the `MENU` rocker button.
- Select `Autom. reset` or `Reset all values and confirm`.
 - » If `Autom. reset` is selected, the trip computer is automatically reset when a minimum of 6 hours have passed and the date has changed since operational readiness was switched off.

Enter the destination address

- Connect a mobile device.
(▣▣▣▣▶ 98)
- Call up the BMW Motorrad Connected app and start the route guidance.
- Call up the `Navigation` menu in the TFT display.
 - » Active route guidance is displayed.
 - If WiFi is not activated on the mobile device, route guidance is displayed as arrow navigation.
 - » If active route guidance is not displayed, consult the troubleshooting chart.
(▣▣▣▣▶ 201)

Select destination from recent destinations

- Navigate to `Navigation`, `Recent destinations`.
- Select and confirm destination.
- Select `Start route guidance`.

Select destination from favourites

- The `FAVOURITES` menu shows all the destinations saved as favourites in the BMW Motorrad Connected app. You cannot use the TFT display to add favourites to the list.

- Navigate to `Navigation`, `Favourites`.
- Select and confirm destination.
- Select `Start guidance`.

Enter special destinations

- Special destinations, such as points of interest, can be displayed on the map.
- Navigate to `Navigation`, `POIs`.

The following locations can be selected:

- At current location
- At destination
- Along the route
- Select where the special destinations should be looked for. For example, the following special destination can be selected:
 - Filling station
- Select and confirm the special destination.
- Select `Start route guidance` and confirm.

Set route criteria

- Navigate to `Navigation`, `Route criteria`.
- The following criteria can be selected:
- Route type
 - Avoid
 - Select desired `Route type`.

106 TFT DISPLAY

- Switch desired *Avoid* on or off.

The number of avoidances activated is displayed in brackets.

View the route information

- Navigate to *Navigation, Settings* and select *Route info*.

You can choose between the following options:

-*Dest.*

-*Waypoint*

- Select the desired option.
» Countdown distance and time are displayed.

Edit route guidance

- Navigate to *Navigation, New destination*.

You can choose from the following destinations:

-*Recent destinations*

-*Favourites*

-*POIs*

- Select a destination from one of the three destination categories.
- Select *Change route guidance* in the destination entry.
- Select *Add as waypoint* to add the selected destination as a waypoint.
- Select *Start guidance* to overwrite the current destination.

End route guidance

- Navigate to *Navigation, Active route guidance*.
- Select *End route guidance* and confirm, or tilt the *Multi-Controller* to the left.

Switch spoken instructions on or off

- Connect the rider's and passenger's helmets. (📡 98)
- The navigation can be read out by a computer voice. For this purpose, *Spoken instruction* must be switched on.
- Navigate to *Navigation, Active route guidance*.
- Switch *Spoken instruction* on or off.

Repeat last spoken instruction

- Navigate to *Navigation, Active route guidance*.
- Select *Current instruction* and confirm.

MEDIA

Precondition

The vehicle is connected to a compatible mobile device and helmet.

Controlling music playback

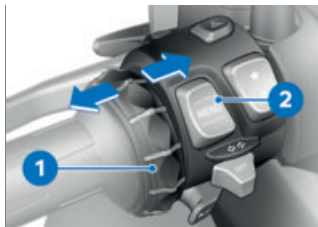

- Call up the **Media** menu.

 BMW Motorrad recommends setting the volume on the mobile end device for media and calls to maximum before setting off.

- Adjust volume. (▮▮▮ 95)
- Next track: Short-tilt Multi-Controller **1** to the right.
- Preceding track or start of current track: Short-tilt Multi-Controller **1** to the left.
- Call up context menu: Press bottom section of button **2**.

 Depending on the mobile device, the scope of the Connectivity functions may be restricted.

- » The following functions can be used in the context menu:
- Playback or Pause.
 - Select the **Now playing**, **All artists**, **All albums** or **All tracks** category for search and playback.

- Select **Playlists**.

You can make the following adjustments in the **Audio settings** submenu:

- Switch **Shuffle** on or off.
- Select **Repeat: Off**, **One** (current track) or **All**.

» If the playlist is not displayed on the TFT display, consult the troubleshooting chart. (▮▮▮ 202)

TELEPHONE

Precondition

The vehicle is connected to a compatible mobile device and helmet.

Telephone calls

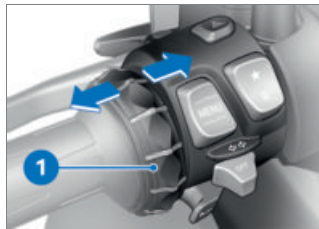

- Call up the **Telephone** menu.

 A pop-up opens when a call is incoming.

- Accept call: Tilt Multi-Controller **1** to the right.

108 TFT DISPLAY

- Reject call: Tilt Multi-Controller **1** to the left.
- End call: Tilt Multi-Controller **1** to the left.

Muting

During active phone calls, the microphone in the helmet can be muted.

Phone calls with multiple participants

While a phone call is in progress, a second call can be accepted. The first phone call is put on hold. The number of active calls is shown in the Telephone menu. It is possible to switch between two phone calls.

Telephone data

Depending on the mobile device, when pairing (📶➡ 97) completes telephone data are automatically sent to the vehicle.

Phone book: List of contacts saved on the mobile device

Call list: List of calls with the mobile device

Favourites: List of favourites saved on the mobile device

DISPLAY SOFTWARE VERSION

- Navigate to Settings, Information, Software version.

DISPLAY LICENCE INFORMATION

- Navigate to Settings, Information, Licences.

ADJUSTMENT

06

MIRRORS	112
HEADLIGHT	112
SPRING PRELOAD	113

112 ADJUSTMENT

MIRRORS

Adjusting mirrors



- Pivot the mirror to the correct position by pressing gently at the edge.

 If the mirror's range of adjustment is not enough to permit correct alignment, the position of the mirror arm has to be changed accordingly.

Adjusting mirror arm



- Push protective cap **1** over the threaded fastener of the mirror arm up to expose the threaded fastener.
- Use a suitable tool to slacken nut **2**.

- Turn the mirror arm to the appropriate position.
- Tighten nut **2** to the specified torque, while holding the mirror arm to ensure that it does not move out of position.



Left mirror (lock nut) to adapter

M10

22 Nm (Left-hand thread)

- Push protective cap **1** over the threaded fastener.

HEADLIGHT

Headlight beam throw and spring preload

Headlight beam throw is generally kept constant when spring preload is adjusted to suit load.

Consult a specialist workshop, preferably an authorised BMW Motorrad retailer, if you are unsure whether the headlight beam-throw setting is correct.

Adjusting headlight beam throw

- Remove the front trim panel. (▶ 172)

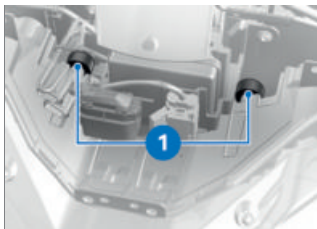

When the vehicle is heavily loaded, spring preload has to be adjusted to prevent the headlight from dazzling on-coming traffic. If adjustment of spring preload is not enough, beam throw has to be corrected at the headlight.

- Adjust headlight beam throw by turning adjusting screws **1**.
- Install the front trim panel. (▶▶▶ 172)

When the E-Scooter is again ridden less heavily loaded:

- Have the basic settings of the headlight restored by a specialist workshop, preferably an authorised BMW Motorrad retailer.

SPRING PRELOAD

Adjustment

It is essential to set spring preload of the rear suspension to suit the load carried by the E-Scooter. Increase spring preload when the vehicle is heavily loaded and reduce spring preload accordingly when the vehicle is lightly loaded.

Adjusting spring preload for spring strut

- Make sure the ground is level and firm and place the E-Scooter on its stand.

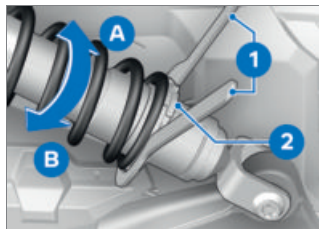

- Loosen lock nut **2**.
- To increase spring preload, use tool **1** from the onboard toolkit to turn the adjuster ring in the direction of arrow **A**.
- To reduce spring preload, use tool **1** from the onboard toolkit to turn the adjuster ring in the direction of arrow **B**.

114 ADJUSTMENT

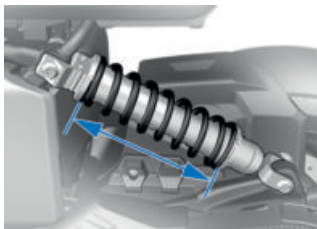

Basic setting of the rear
spring preload

Spring length in basic setting
257.5 mm (with rider 85 kg)

Spring length in basic setting
257.5 mm (One-up riding
without luggage)

Spring length in basic setting
247.5 mm (One-up with lug-
gage)

Spring length in basic setting
227.5 mm (Two-up with lug-
gage)

- Tighten locknut **2**.

BMW EPOWER

07

PRINCIPLE	118
GENERAL NOTES	118
CHARGING CABLE	120
CHARGING PROCESS	122

PRINCIPLE

The vehicle can be operated without any emissions whatsoever on account of its electric drive.

The special high-voltage battery unit supplies energy to the electrical machine.

In all riding situations, including for example pullaway and acceleration, and also at higher speeds, the torquey electrical machine provides dynamic riding characteristics.

The high-voltage battery unit is recharged with a charging cable, for example while the vehicle is parked, or while on the move by energy recovery.

Charging at special power supplies is particularly fast. But it is also possible to recharge at ordinary household sockets for example in private houses.

Energy recovery

The high-voltage battery unit is partly recharged by energy recovery while the vehicle is on the move. Energy recovery ensures that very little energy is lost by deceleration. When the vehicle decelerates the electrical machine acts as a generator, converting kinetic energy partly or completely into elec-

tricity. This partly recharges the high-voltage battery unit, helping to maximise range. This recharging can take place while the vehicle is on the move with the e-throttle grip closed or in energy recovery mode.

For more information on energy recovery by deceleration see the section entitled "Riding" (▣ 142).

In the instrument cluster, the marker is in the CHARGE part of the gauge. It is important to think well ahead and reduce speed in good time in order to make the best possible use of the vehicle's energy recovery capability.

GENERAL NOTES



DANGER

Handling of electrical current not in compliance with correct procedure.

Injury or damage to property, e.g. by electric shock or fire.

- Comply with the safety regulations.

**ATTENTION****No check of charging equipment prior to initial use**

Damage to property and overloading of the electricity supply system

- Before charging for the first time, have your charging equipment checked at the place of use by a duly trained and qualified electrical specialist.

**CAUTION****Non-compliance with the instructions posted at the charging station**

Injury or damage to property, e.g. by electric shock or fire

- Comply with the instructions posted at the charging station.

**ATTENTION****Charging equipment in poor condition**

Risk of fire, e.g. due to worn contacts or damage

- Use only charging equipment that is in perfect condition.

**DANGER****Cleaning of charging socket not in compliance with correct procedure.**

Injury or damage to property, e.g. by electric shock or fire.

- Have cleaning undertaken only by appropriately trained persons.



Do not leave the E-Scooter out of use for a lengthy period with the high-voltage battery in a low state of charge.

Before leaving the vehicle out of use for a lengthy period, check the charge status indicator and make sure that the high-voltage battery is fully charged. Excessive deep discharge will damage the high-voltage battery.



Recharge the high-voltage battery when the range is down to 30 km, as otherwise the performance of the electric drive could drop off perceptibly.

What to do after an accident

DANGER

Touching high-voltage cables after an accident.

Danger to life due to electric shock hazard.

- After an accident, do not touch high-voltage components, for example the orange-coloured high-voltage cables, or parts in contact with exposed high-voltage cables.

CAUTION

Fluid escaping from the high-voltage battery

Risk of caustic burns

- Do not touch fluids escaping from the high-voltage battery.

If you and your vehicle are involved in an accident, the following additional safety precautions apply in relation to the high-voltage system:

- Secure the scene of the accident.
- Immediately notify rescue workers, police or fire service that they are dealing with a

vehicle with high-voltage system.

- Switch off operational readiness.
- Do not inhale gases escaping from the vehicle; if necessary, remain a safe distance from the vehicle.

CHARGING CABLE

DANGER

Use of unapproved charging cables.

Injury or damage to property, e.g. by cable fire.

- Use only approved charging cables and charging stations for recharging.
- The Service partner will provide information on approved cables on request.

**ATTENTION****Use of the charging cable not in compliance with correct procedure**

Damage to property, e.g. due to cable fire

- Use the charging cable only for recharging the E-Scooter.
- Do not attempt to extend the charging cable by connecting other cables or adapters.

**DANGER****Use of damaged charging cable.**

Injury or damage to property, e.g. by electric shock or fire.

- Do not use a damaged charging cable.
- Immediately remove a damaged charging cable (housing or cable) from service.



Opening the charging-cable components causes irreparable damage and voids the warranty. Only the manufacturer can undertake repair work on the charging cable or replace components (plug, connector or Incable Modul).



Always fit the protective cap to the on-vehicle charging interface to keep out moisture and dirt.

Different charging cables are required depending on national-market version; the appropriate cable is included in the scope of delivery.

The charging cable can be stowed in the helmet compartment.

Alternatively, use a permanently installed cable of a charging station.

Standard charging cable

You can use the standard charging cable to charge by connecting to a household socket with protective earth. Connected to a household socket as power supply, charging is with alternating current.

It is essential to comply with the instructions in the detailed operating instructions of the standard charging cable:

www.apativ.com/online-manual

Indicators of the standard charging cable

The standard charging cable has four LEDs as status indicators.

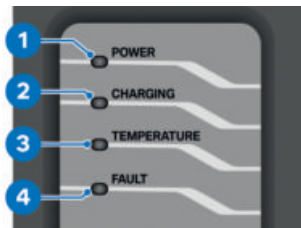

1: Power supply from the household socket or, as applicable, from the charging station

2: Charge indicator

3: Temperature monitoring

4: Fault from the household socket or, as applicable, from the charging station or the charging unit

CHARGING PROCESS

Before charging

DANGER

Non-compliance with the safety information for the electrical outlet.

Injury or damage to property, e.g. by electric shock or fire.

- Comply with the safety instructions for the electricity outlet you are using.

ATTENTION

Charge current not matched to the electricity supply system

Risk of fire, e.g. due to overheating of a domestic power outlet or overloading of the electricity supply system

- Before using a domestic power outlet, check the outlet's maximum rating and match the charge current limitation to the electricity supply system.

 You can interrupt charging at any time and resume later, for example if other power supply is needed for other consumers in the interim, or if you prefer to avoid a high power draw with several consumers all connected at the same time.

 If interrupted, for example by a temporary power failure, charging resumes automatically as soon as power is restored. If the interruption lasts for more than 2 minutes, charging does not resume automatically.

 Charging is slowed at extreme ambient temperatures in order to protect the high-voltage battery.

 The standard charging cable does not work at temperatures lower than $-32\text{ }^{\circ}\text{C}$. Before charging, place the charging cable where ambient temperature is between $-32\text{ }^{\circ}\text{C}$ and $40\text{ }^{\circ}\text{C}$.

Opening and closing charging compartment



- Open charging compartment hinged lid **1** by means of grip **2**.
- » When opened, the charging compartment hinged lid is not suitable for placing objects on.
- To close: Firmly press charging compartment lid **1** into the lock.

Adjusting the charge current

- Switch on operational readiness. (☰➔ 61)
- Adjust the charge current by navigating to **Settings**, **Vehicle settings**, **Charging settings**, **Charging curr. limit**.

 If a different charge current is available from the domestic power outlet or the charging station, the lower charge current is used for charging.

Starting charging process

- without Canada export^{NV}
- without Taiwan export^{NV}

- Switch off operational readiness. (☰➔ 61)
- » The charging process does not start until operational readiness has been switched off. Switching on operational readiness while charging is in progress immediately interrupts the charging process.
- Open the charging compartment.

124 BMW EPOWER

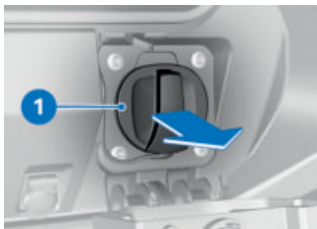

- Remove charging interface cap 1.
- Remove the protective cap from the charging plug.

ATTENTION

Charge current not matched to the electricity supply system

Risk of fire, e.g. due to overheating of a domestic power outlet or overloading of the electricity supply system

- Before using a domestic power outlet, check the outlet's maximum rating and match the charge current limitation to the electricity supply system.
- Before charging for the first time at home-base household socket and always before charging at a household socket away from home base, ascertain the permitted charge current strength, for

example by consulting a qualified electrician. If the permissible charge current strength is unknown, set charge current limitation to the lowest setting.

- » The ex-works default setting for charge current limitation is 6 A charge current.
- Adjust the charge current limitation if necessary by navigating to Settings, Vehicle settings, Charging settings, Charging curr. limit.

 If a different charge current is available from the domestic power outlet or the charging station, the lower charge current is used for charging.

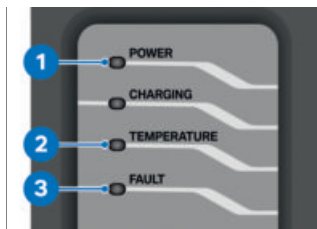

- As applicable, connect the standard charging cable to the household socket or the Mode3 charging cable to the charging station. If you are charging at a charging station,

follow the instructions posted at the station.

- » The standard charging cable automatically runs all the necessary check steps. When LED **1** shows green, this confirms that the test was successful. If LED **2** or **3** lights up or flashes, the test was not successful and the charging process cannot start or it is not permissible to connect this charging cable to the vehicle. The following test steps are performed:

- Check of the household socket for incorrect wiring
- Check for presence of a protective earth
- Check of the preconditions for correct charging
- » Status indicators / fault messages are listed in the section entitled "Displays". Fault messages can be reset as follows:
- Disconnect the standard charging cable from the power supply by unplugging it from the household socket.
- Wait 10 seconds and re-insert the plug.
- » Critical faults indicating that the standard charging cable is damaged cannot be reset. These faults include:

- Relay welded (device permanently faulty)
- Temperature sensor faulty
- Fault-current test returned a negative result

DANGER

Use of damaged charging cable.

Injury or damage to property, e.g. by electric shock or fire.

- Do not use a damaged charging cable.
- Immediately remove a damaged charging cable (housing or cable) from service.
- Have the fault rectified as soon as possible by an authorised BMW Motorrad retailer.



- Connect charging cable **2** to charging interface **1**.
- » The charging cable is electrically locked when oper-

126 BMW EPOWER

ational readiness is off and when charging is in progress.

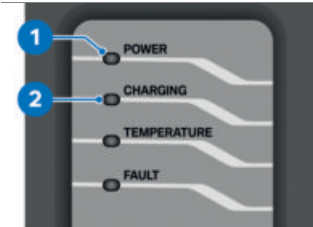

- Check the indicator lights on the charging cable.
 - » The standard charging cable automatically runs all the necessary check steps. LED **1** lights up and LED **2** flashes to indicate that the test was successful and that the vehicle is being charged.

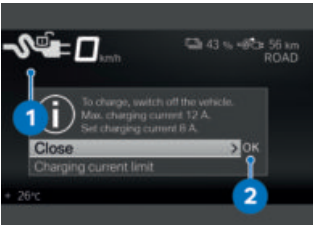

Notifier **2** appears when operational readiness is switched on. Symbol **1** indicates that the charging cable is connected, but the charging process has not yet been started. You can select a charge current limita-

tion, or start the charging process directly by switching the vehicle off.

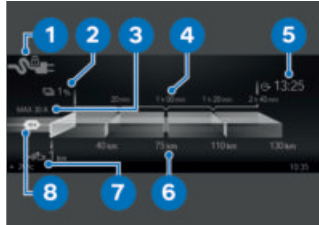

Symbol **1** for the status of charging plug detection appears. State of charge **2** and range **7** are displayed. Charging time forecast **4** in combination with range forecast **6** indicates how long the vehicle has to be recharged in order for it to be able to achieve a certain estimated range. Target time **5** indicates the time by when the vehicle will have reached 100 % charge. Target time is always based on the clock time set on the vehicle. Along with the active charge current limit **8** the maximum available charge current strength **3** is shown if the infrastructure offers a higher current than that selected in the Settings menu. After a certain time the display is automatically switched to

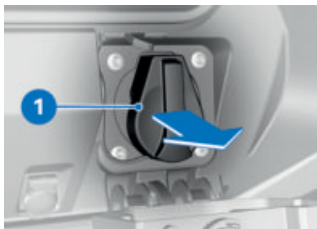

- Remove charging interface cap 1.
- Remove the protective cap from the charging plug.

ATTENTION

Charge current not matched to the electricity supply system

Risk of fire, e.g. due to overheating of a domestic power outlet or overloading of the electricity supply system

- Before using a domestic power outlet, check the outlet's maximum rating and match the charge current limitation to the electricity supply system.
- Before charging for the first time at home-base household socket and always before charging at a household socket away from home base, ascertain the permitted charge current strength, for

example by consulting a qualified electrician. If the permissible charge current strength is unknown, set charge current limitation to the lowest setting.

- » The ex-works default setting for charge current limitation is 6 A charge current.
- Adjust the charge current limitation if necessary by navigating to Settings, Vehicle settings, Charging settings, Charging curr. limit.



If a different charge current is available from the domestic power outlet or the charging station, the lower charge current is used for charging.

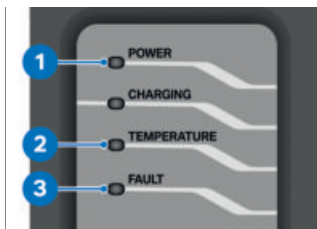

- As applicable, connect the standard charging cable to the household socket or the Mode3 charging cable to the charging station. If you are charging at a charging station,

follow the instructions posted at the station.

- » The standard charging cable automatically runs all the necessary check steps. When LED **1** shows green, this confirms that the test was successful. If LED **2** or **3** lights up or flashes, the test was not successful and the charging process cannot start or it is not permissible to connect this charging cable to the vehicle. The following test steps are performed

- Check of the household socket for incorrect wiring
- Check for presence of a protective earth
- Check of the preconditions for correct charging
- » Status indicators / fault messages are listed in the section entitled "Displays". Fault messages can be reset as follows:
- Disconnect the standard charging cable from the power supply by unplugging it from the household socket.
- Wait 10 seconds and re-insert the plug.
- » Critical faults indicating that the standard charging cable is damaged cannot be reset. These faults include:

- Relay welded (device permanently faulty)
- Temperature sensor faulty
- Fault-current test returned a negative result

DANGER

Use of damaged charging cable.

Injury or damage to property, e.g. by electric shock or fire.

- Do not use a damaged charging cable.
- Immediately remove a damaged charging cable (housing or cable) from service.
- Have the fault rectified as soon as possible by an authorised BMW Motorrad retailer.



- Connect charging cable **2** to charging interface **1**.
- » The charging cable is electrically locked when oper-

130 BMW EPOWER

ational readiness is off and when charging is in progress.

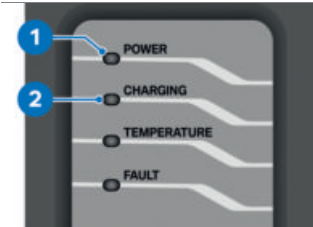

- Check the indicator lights on the charging cable.
 - » The standard charging cable automatically runs all the necessary check steps. LED **1** lights up and LED **2** flashes to indicate that the test was successful and that the vehicle is being charged.

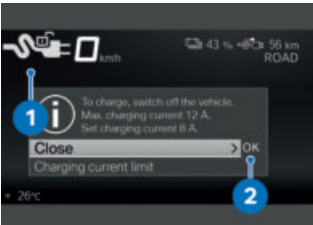

Notifier **2** appears when operational readiness is switched on. Symbol **1** indicates that the charging cable is connected, but the charging process has not yet been started. You can select a charge current limita-

tion, or start the charging process directly by switching the vehicle off.

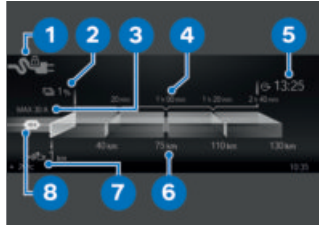

Symbol **1** for the status of charging plug detection appears. State of charge **2** and range **7** are displayed. Charging time forecast **4** in combination with range forecast **6** indicates how long the vehicle has to be recharged in order for it to be able to achieve a certain estimated range. Target time **5** indicates the time by when the vehicle will have reached 100 % charge. Target time is always based on the clock time set on the vehicle. Along with the active charge current limit **8** the maximum available charge current strength **3** is shown if the infrastructure offers a higher current than that selected in the Settings menu. After a certain time the display is automatically switched to

Stand-by-Modus (energy saving mode). The charging process resumes

–with quick charger^{OE}

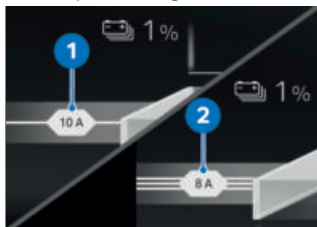

The display shows whether charging is single-phase **1** or three-phase **2**.◀

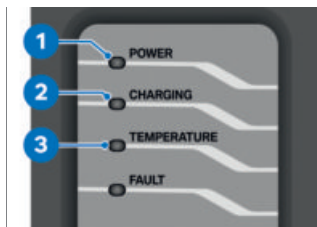

- Check the indicator lights on the charging cable.
- » If LEDs **1** and **3** light up charging has been interrupted due to excessively high temperature – if LED **2** flashes as well charging is continuing but at a lower rate. If LED **1** lights up and LED **3** flashes, charging has been interrupted due to

excessively high temperature in the line plug. The following test steps are performed:

- Check for presence of a protective earth
- Check of the preconditions for correct charging
- Short-press the **MENU** button to view the current state of charge again.
- » If charging time is longer than expected, check the **Charging curr. limit** setting.

Ending charging process

- without Canada export^{NV}
- without Taiwan export^{NV}

Requirement

It is very important to step through the procedure in the correct sequence when ending the charging process.

Requirement

If you are charging at a charging station, end the charging process at the charging station before disconnecting the charging cable.

- Switch on operational readiness.
- » The charging cable is unlocked at the E-Scooter.

132 BMW EPOWER



- Disconnect charging cable **2** from charging interface **1** on the E-Scooter.



- Install charging interface cap **1**.
- As applicable, disconnect the standard charging cable from the household socket or the Mode3 charging cable from the charging station.
- Seat the protective cap on the charging plug.
- Stow the standard charging cable in the helmet compartment, or after charging at a charging station return the permanently installed charging

cable to its intended parked location.

Ending charging process

- with Canada export^{NV}
- or
- with Taiwan export^{NV}

Requirement

It is very important to step through the procedure in the correct sequence when ending the charging process.

Requirement

If you are charging at a charging station, end the charging process at the charging station before disconnecting the charging cable.

- Switch on operational readiness.
- » The charging cable is unlocked at the E-Scooter.

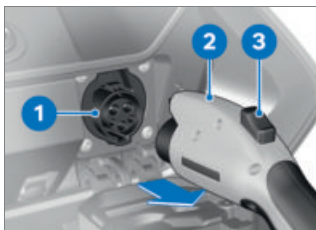

- Press release button **3** and disconnect charging cable **2**

from charging interface **1** on the E-Scooter.



- Install charging interface cap **1**.
- As applicable, disconnect the standard charging cable from the household socket or the Mode3 charging cable from the charging station.
- Seat the protective cap on the charging plug.
- Stow the standard charging cable in the helmet compartment, or after charging at a charging station return the permanently installed charging cable to its intended parked location.

Emergency unlocking of charging plug

- Remove the front trim panel. (▮▮▮▮▶ 172)

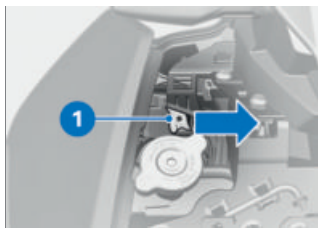

- Using a suitable tool if necessary, push emergency-unlock lever **1** in the direction indicated by the arrow.
- » Charging plug unlocked.
- Install the front trim panel. (▮▮▮▮▶ 172)

RIDING

08

SAFETY INFORMATION	136
COMPLY WITH CHECKLIST	137
ALWAYS BEFORE RIDING OFF	138
EVERY 10TH CHARGING PROCESS	138
ESTABLISHING RIDING READINESS	138
RIDING THE E-SCOOTER	141
RUNNING IN	143
BRAKES	144
PARKING YOUR E-SCOOTER	145
SECURING E-SCOOTER FOR TRANSPORTATION	146

SAFETY INFORMATION

Tampering

ATTENTION

Tampering with the E-Scooter

Damage to the affected parts, failure of safety-relevant functions. Damage due to tampering is not covered by the warranty.

- Do not tamper with the vehicle in any way that could result in tuned performance.

Rider's equipment

Do not ride without the correct clothing! Always wear

- Helmet
- Suit
- Gloves
- Boots

This applies even to short journeys, and to every season of the year. Your authorised BMW Motorrad retailer will be happy to advise you on the correct clothing for every purpose.

WARNING

Loose textiles, items of luggage or straps snagged by open rotating parts of the vehicle (wheels, drive shaft)

Risk of accident

- Make sure that loosely worn or carried textiles cannot be snagged by openly rotating parts of the vehicle.
- Keep all items of luggage and straps well clear of openly rotating parts of the vehicle.

Load

WARNING

Handling adversely affected by overloading and imbalanced loads

Risk of falling

- Do not exceed the permissible gross weight and be sure to comply with the instructions on loading.
- Adjust spring preload and tyre pressures to suit total weight.
- Note the maximum permissible payload of the helmet compartment.

	Payload of the helmet compartment
max 8 kg	

–with topcase^{OA}

- Note the maximum permissible payload of the topcase.

	Payload of topcase
max 5 kg	

Speed

If you ride at high speed, always bear in mind that various boundary conditions can adversely affect the handling of your E-Scooter:

- Settings of the spring-strut and shock-absorber system
- Imbalanced load
- Loose clothing
- Insufficient tyre pressure
- Poor tyre tread
- Mounted luggage systems such as a topcase

Risk of poisoning



Inhalation of harmful vapours

Health hazard

- Do not inhale vapours from operating fluid and plastics.
- Use the vehicle only outdoors.

Tampering



Tampering with the E-Scooter

Damage to the affected parts, failure of safety-relevant functions. Damage due to tampering is not covered by the warranty.

- Do not tamper with the vehicle in any way that could result in tuned performance.

COMPLY WITH CHECKLIST

- At regular intervals, use the checklist below to check your E-Scooter.

ALWAYS BEFORE RIDING OFF

Requirement

Always before riding off:

- Check the state of charge of the high-voltage battery.
- Check operation of the brake system.
- Check operation of the lights and signalling equipment.
- Check the tyre tread depth. (▣▣▣ 171)
- Check the tyre pressures. (▣▣▣ 170)
- Check that topcase and luggage are securely fastened.

EVERY 10TH CHARGING PROCESS

Requirement

Every 10th charging process:

- Check the brake pad thickness, front brakes. (▣▣▣ 165)
- Check the brake pad thickness, rear brakes. (▣▣▣ 166)
- Check the brake-fluid level, front and rear wheel brakes. (▣▣▣ 167)

ESTABLISHING RIDING READINESS

Pre-Ride-Check

The instrument cluster runs a test of the instruments and the indicator and warning lights when operational readiness is switched on. This test is known as the Pre-Ride-Check. The test is aborted if you switch on riding readiness before it completes.

Phase 1

All indicator and warning lights are switched on.

After a longer vehicle stand-still period, an animation is displayed when the system starts up.

Phase 2

The 'General' warning light changes from red to yellow.

Phase 3

All the indicator and warning lights switched on in the initial phase are switched off in reverse sequence.

The malfunction indicator lamp (MIL) does not go out until 15 seconds have elapsed.

If one of the indicator and warning lights did not switch on:

- Have the fault rectified as quickly as possible by a specialist workshop, preferably an authorised BMW Motorrad retailer.

 The intervention of riding dynamics control systems can be restricted, depending on which riding mode is selected and how the selected mode is configured.

Possible restrictions are indicated by a pop-up message, for example *Warning! ABS & DTC setting*.

See the section entitled "Engineering details" for more information on riding dynamics control systems such as ABS and DTC.

ABS self-diagnosis

BMW Motorrad ABS performs self-diagnosis to ensure its operability. Self-diagnosis is performed automatically when you switch on operational readiness.

Phase 1

» System components are checked at standstill.



flashes.

Phase 2

- » System components are checked as the vehicle pulls away.
- ABS self-diagnosis completed. The ABS symbol no longer shows.
- Observe all the indicator and warning lights.



ABS self-diagnosis not completed

The ABS function is not available, because self-diagnosis did not complete. (The E-Scooter has to reach a defined minimum speed for the wheel sensors to be checked: min 5 km/h)

If an indicator showing an ABS fault appears when ABS self-diagnosis completes:

- You can continue to ride. Bear in mind that the ABS function is not available or the functionality might be subject to certain restrictions.
- Have the fault rectified as soon as possible by an authorised BMW Motorrad retailer.

140 RIDING

ASC/DTC self-diagnosis

BMW Motorrad ASC/DTC performs self-diagnosis to ensure its operability. Self-diagnosis is performed automatically when you switch on operational readiness.

Phase 1

» Test of the diagnosis-compatible system components with the vehicle at a standstill.



slow-flashes.

Phase 2

» Pullaway test of the diagnosis-compatible system components.



slow-flashes.

ASC/DTC self-diagnosis completed

» The ASC/DTC symbol no longer shows.

- Check all the warning and indicator lights.



ASC/DTC self-diagnosis not completed

The E-Scooter has to reach a defined minimum speed with riding readiness switched on for the wheel speed sensors to be checked:

min 5 km/h

If an indicator showing an ASC/DTC fault appears when ASC/DTC self-diagnosis completes:

- You can continue to ride.
Bear in mind that the ASC/DTC is not available.
- Have the fault rectified as quickly as possible by a specialist workshop, preferably an authorised BMW Motorrad retailer.

E-Scooter ready for operation

When the Pre-Ride-Check and the ABS self-diagnosis complete, the E-Scooter with all consumers is ready for operation.



To preserve the 12 V battery, only use active electrical consumers for as long as is absolutely necessary and switch off operating readiness.

RIDING THE E-SCOOTER

E-Scooter ready to ride



The E-Scooter is ready to ride when you press the starter button with the brake applied. The drive indicator becomes visible and **READY** is displayed. All systems are operational. If you press the emergency-off switch the E-Scooter is no longer ready to ride.

 Power output and power draw are adversely affected by low temperatures.

 In exceptional cases it is possible for the high-voltage battery to warm up to a high temperature while the vehicle is at a standstill (e.g. in extreme ambient temperatures and direct sunlight). If the high-voltage battery overheats the E-Scooter is not in the ride-ready state.

 Very high temperatures (above 35 °C) shorten the service life of the battery cells. If the high-voltage battery overheats while you are riding, drive power is reduced step by step to allow the high-voltage battery to cool. The reading shown by the **POWER** indicator in the instrument cluster drops. If the temperature continues to rise stop the vehicle and allow the high-voltage battery to cool. If the reading of the power indicator drops to 0, the E-Scooter is no longer in the ride-ready state and the vehicle will come to a stop.

Switching on riding readiness

- Switch on operational readiness. (➡ 61)
- » Pre-Ride-Check is performed. (➡ 138)
- » ABS self-diagnosis is in progress. (➡ 139)
- » ASC/DTC self-diagnosis is in progress. (➡ 140)
- Apply the brake.

position is similar to light braking.

Energy can be recovered when the following conditions are satisfied:

- E-Scooter is on the move.
- Speed is higher than approx. 5 km/h.

Energy cannot be recovered in the following situations:

- The high-voltage battery unit is fully charged.
- The high-voltage battery unit is at a very high or very low temperature. In winter or summer there is a possibility of energy recovery being temporarily unavailable just after you pull away.



WARNING

Without energy recovery there is no braking effect from the electric drive. The E-Scooter could coast further than usual.

Risk of accident

- Always be prepared to brake.

Riding situations for deceleration

Whenever you know that you are about to decelerate as you ride, you can make use of the

deceleration phase for energy recovery. The following are typical riding situations suitable for use for this purpose:

- Deceleration on a descent
- Deceleration approaching a red traffic light

Avoid late or sharp braking. Instead, make use of the energy recovery function to slow the vehicle.

RUNNING IN

Brake pads

New brake pads have to bed down before they can achieve their optimum friction levels. You can compensate for this initial reduction in braking efficiency by exerting greater pressure on the levers.



WARNING

New brake pads

Longer stopping distance, risk of accident

- Apply the brakes in good time.

144 RIDING

Tyres

New tyres have a smooth surface. This must be roughened by riding in a restrained manner at various heel angles until the tyres are run in. This running in procedure is essential if the tyres are to achieve maximum grip.



WARNING

New tyres losing grip on wet roads and at extreme bank angles

Risk of accident

- Ride carefully and avoid extremely sharp inclines.

BRAKES

How can stopping distance be minimised?

Each time the brakes are applied, a load distribution shift takes place with the load shifting forward from the rear to the front wheel. The sharper the vehicle decelerates, the more load is shifted to the front wheel. The higher the wheel load, the more braking force can be transmitted without the wheel locking.

To optimise stopping distance, apply the front brakes rapidly and keep on increasing the

force you apply to the brake lever. This makes the best possible use of the dynamic increase in load at the front wheel. When high braking pressure is applied sharply the dynamic shift in load distribution cannot keep pace with the increase in deceleration and the tyres cannot transmit the full braking force to the surface of the road.

Descending mountain passes



WARNING

Braking only with the rear brake on mountain descents.

Brake fade. Destruction of the brakes due to overheating.

- Use both front and rear brakes, and make use of the energy recovery function as well.

For further information about energy recovery see the section entitled "Engineering details" from page (111➔ 156) onward.

Wet and dirty brakes

Wetness and dirt on the brake discs and the brake pads diminish braking efficiency.

Delayed braking action or poor braking efficiency must be reckoned with in the following situations:

- Riding in the rain or through puddles of water.
- After the vehicle has been washed.
- Riding on salted or gritted roads.
- After work has been carried on the brakes, due to traces of oil or grease.
- Riding on dirt-covered surfaces or off-road.



WARNING

Wetness and dirt result in diminished braking efficiency

Risk of accident

- Apply the brakes lightly while riding to remove wetness and dirt, or dismount and clean the brakes.
- Think ahead and brake in good time until full braking efficiency is restored.

PARKING YOUR E-SCOOTER

Side stand

- Switch off riding readiness.



ATTENTION

Poor ground underneath the stand

Risk of damage to parts if vehicle topples

- Always check that the ground under the stand is level and firm.

- Extend the side stand and prop the E-Scooter on the stand.
- » Extending the side stand automatically applies the parking brake. It prevents the vehicle from rolling away.



ATTENTION

Additional weight placing strain on the side stand

Risk of damage to parts if vehicle topples

- Do not sit or lean on the vehicle while it is propped on the side stand.
- Turn the handlebars all the way to the left.

146 RIDING

Centre stand

—with centre stand^{OE}

- Switch off riding readiness.



ATTENTION

Poor ground underneath the stand

Risk of damage to parts if vehicle topples

- Always check that the ground under the stand is level and firm.



ATTENTION

Centre stand retracts due to severe movements

Risk of damage to parts if vehicle topples

- Do not lean or sit on the vehicle with the centre stand extended.
- Extend the centre stand and lift the E-Scooter on to the stand. In this process, lift the E-Scooter only by the passenger grab handles or the grab handles on the topcase carrier.

contact with straps used to secure the motorcycle are adequately protected against scratching (e.g. with adhesive tape).



ATTENTION

Vehicle topples to side when being lifted on to stand

Risk of damage to parts if vehicle topples

- Secure the vehicle to prevent it toppling, preferably with the assistance of a second person.
- Push the E-Scooter on to the transportation flat and hold it in position: do not place it on the side stand or centre stand.

SECURING E-SCOOTER FOR TRANSPORTATION

- Make sure that all components that might come into

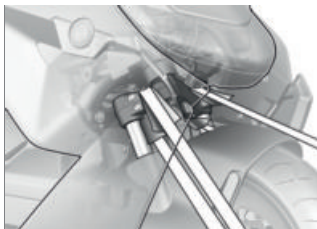

ATTENTION

Trapping of components

Component damage

- Do not trap components such as brake lines or cable legs.
- At the front, loop a strap round the bottom fork bridge on each side and tighten the straps.

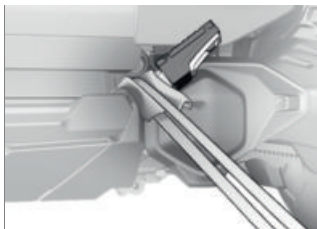

- At the rear left, secure the ratchet strap to the retaining plate of the footrest.
- Tighten all the ratchet straps uniformly; the suspension of the E-Scooter should be compressed as tightly as possible front and rear.



- At the rear right, secure the ratchet strap to the retaining plate of the footrest.

ENGINEERING DETAILS

09

GENERAL NOTES	150
ANTILOCK BRAKE SYSTEM (ABS)	150
TRACTION CONTROL (ASC/DTC)	153
ENERGY RECOVERY STABILITY CONTROL (RSC)	155
RIDING MODE	156
DYNAMIC BRAKE CONTROL	157
TYRE PRESSURE CONTROL (RDC)	158
ADAPTIVE HEADLIGHT	160

GENERAL NOTES

To find out more about engineering, go to bmw-motorrad.com/technik.

ANTILOCK BRAKE SYSTEM (ABS)

How does ABS work?

The amount of braking force that can be transferred to the road depends on factors that include the coefficient of friction of the road surface. Loose stones, ice and snow or a wet road all have much lower coefficients of friction than a clean, dry asphalt surface. The lower the coefficient of friction, the longer the stopping distance. If the rider increases braking pressure to the extent that braking force exceeds the maximum transferable limit, the wheels start to lock and the vehicle loses its directional stability; a fall is imminent. Before this situation can occur, ABS intervenes and adapts braking pressure to the maximum transferable braking force, so the wheels continue to turn and directional stability is maintained irrespective of the condition of the road surface.

What are the effects of surface irregularities?

Humps and surface irregularities can cause the wheels to lose contact temporarily with the road surface; if this happens the braking force that can be transmitted to the road can drop to zero. If the brakes are applied under these circumstances the ABS has to reduce braking force to ensure that directional stability is maintained when the wheels regain contact with the road surface. At this instant the BMW Motorrad ABS must assume an extremely low coefficient of friction (gravel, ice, snow), so that the wheels will continue to rotate under all imaginable circumstances, because this is the precondition for ensuring directional stability. As soon as it registers the actual circumstances, the system reacts instantly and adjusts braking force accordingly to achieve optimum braking.

Rear wheel lift

Under very severe and sudden deceleration, however, under certain circumstances it is possible that the BMW Motorrad ABS will be unable to prevent the rear wheel from lifting clear of the ground. If this happens the outcome can be a highside situation in which the E-Scooter can flip over.



WARNING

Rear wheel lift due to severe braking

Risk of falling

- When you brake sharply, bear in mind that ABS control cannot always be relied on to prevent the rear wheel from lifting clear of the ground.

What is the design baseline for BMW Motorrad ABS?

Within the limits imposed by physics, the BMW Motorrad ABS ensures directional stability on any surface.

At speeds above 4 km/h, within the limits imposed by physics the BMW Motorrad ABS can ensure directional stability on any surface. Limitations inherent to the design principle mean that at lower speeds the BMW Motorrad ABS cannot provide optimum assistance on all surfaces.

The system is not optimised for special requirements that apply under extreme competitive conditions off-road or on the track.

Special situations

The speeds of the front and rear wheels are compared as one means of detecting a wheel's incipient tendency to lock. If the system registers implausible values for a lengthy period the ABS function is deactivated for safety reasons and an ABS fault message is issued. Self-diagnosis has to complete before fault messages can be issued. In addition to problems with the BMW Motorrad ABS, exceptional riding conditions can lead to a fault message being issued:

152 ENGINEERING DETAILS

- Riding for a lengthy period with the front wheel lifted off the ground (wheelie).
- Rear wheel rotating with the vehicle held stationary by application of the front brake (burn-out).
- Rear wheel locked by the electrical machine's braking moment for a lengthy period, for example while descending on a loose or slippery surface.

If a fault message is issued on account of exceptional riding conditions, you can reactivate the ABS function by switching operational readiness off and on again.

What significance devolves on regular servicing?



WARNING

Brake system not regularly serviced

Risk of accident

- In order to ensure that the BMW Motorrad ABS is always maintained in optimum condition, it is essential for you to comply strictly with the specified inspection intervals.

Safety reserves

The potentially shorter braking distances which BMW Motorrad ABS permits must not be used as an excuse for careless riding. The system is primarily a means of ensuring a safety margin in genuine emergencies.

Take care when cornering!

When you apply the brakes on a corner, the vehicle's weight and momentum take over and even BMW Motorrad ABS is unable to counteract their effects.

Evolution of ABS to ABS Pro

-with riding modes Pro^{OE}

Until now, the BMW Motorrad ABS helped ensure a very high degree of safety for braking with the vehicle upright and travelling in a straight line. Now ABS Pro offers enhanced safety for braking in corners as well. ABS Pro prevents the wheels from locking even under sharp braking. ABS Pro reduces abrupt changes in steering force, particularly in panic-braking situations, counteracting the vehicle's otherwise natural but undesirable tendency to straighten up.

ABS intervention

Technically speaking, depending on the riding situation ABS Pro adapts ABS intervention to the E-Scooter's bank angle. Signals for rate of roll and rate of yaw and lateral acceleration are used to calculate bank angle.

As the vehicle is heeled over more and more as it banks into a corner, an increasingly strict limit is imposed on the brake-pressure gradient for the start of brake application. This slows the build-up of brake pressure to a corresponding degree. Additionally, pressure modulation is more uniform across the range of ABS intervention.

Advantages for the rider

The advantages of ABS Pro for the rider are sensitive response and high braking and directional stability combined with best-case deceleration of the vehicle, even when cornering.

TRACTION CONTROL (ASC/DTC)

How does traction control work?

Traction control is available in two versions

- without** provision for bank angle when cornering: Automatic Stability Control (ASC)
- ASC is a rudimentary function intended to prevent falls.
- with** provision for bank angle when cornering: Dynamic Traction Control (DTC)
- DTC regulation is more delicate and more comfortable thanks to the additional bank angle and acceleration information.

Traction control compares the front and rear wheel circumferential velocities. The differential is used to compute slip as a measure of the reserves of stability available at the rear wheel. If slip exceeds a certain limit, the electrical machine management system intervenes and adapts torque accordingly. BMW Motorrad ASC/DTC is designed as an assistant system for the rider and for use on public roads. The extent to which the rider affects ASC/DTC control can be consider-

154 ENGINEERING DETAILS

able (weight shifts when cornering, items of luggage loose on the vehicle), especially when the style of riding takes rider and machine close to the limits imposed by physics.



WARNING

Risky riding

Risk of accident despite ASC/DTC

- Invariably, it remains the rider's responsibility to adapt riding style to riding conditions.
- Do not take risks that would negate the additional safety offered by this system.

Special situations

In accordance with the laws of physics, the ability to accelerate is restricted more and more as the angle of heel increases. Consequently, there can be a perceptible reduction in acceleration out of very tight bends.

The speeds of the front and rear wheels are compared and DTC, unlike ASC, also takes the bank angle into account in processing data to detect the rear wheel's incipient tendency to spin or slip sideways.

–with riding modes Pro^{OE}
If the electronic processor receives values for the bank angle that it considers implausible over a lengthy period, a dummy value is used for the bank angle or the DTC function is switched off. Under these circumstances the indicator for a DTC fault shows. Self-diagnosis has to complete before fault messages can be issued.

The BMW Motorrad Traction Control can shut down automatically under the exceptional riding conditions outlined below.

Exceptional riding conditions:

- Riding for a lengthy period with the front wheel lifted off the ground (wheelie).
- Rear wheel rotating with the vehicle held stationary by application of the front brake (burn-out).
- Warming up with the vehicle on an auxiliary stand



Minimum speed for activation of DTC

min 5 km/h

–with riding modes Pro^{OE}

If the front wheel lifts clear of the ground under severe acceleration, in all riding modes the DTC reduces torque until the front wheel regains contact with the ground.

If the front wheel lifts clear of the ground, BMW Motorrad recommends rolling the e-throttle grip slightly closed so as to restore stability with the least possible delay.

In ECO riding mode, the DTC setting corresponds to the ROAD riding mode.

In RAIN, ROAD and DYNAMIC riding modes, the DTC setting corresponds to the riding mode.

ENERGY RECOVERY STABILITY CONTROL (RSC)

How does energy recovery stability control RSC work?

The purpose of energy recovery stability control is to prevent the unstable riding states that can be produced by excessive energy-recovery braking moment acting on the rear wheel. Depending on the road condition and riding dynamic, excessive energy recovery braking moment can produce a sharp rise in rear-wheel slip

and impair directional stability. Energy recovery stability control limits this slip at the rear wheel to a safe, mode-dependent regulated slip.

Causes for excessive slip at the rear wheel:

- Riding in energy recovery mode on a surface with a low coefficient of friction (e.g. wet leaves).
- Sharp braking during sporty riding.

In the same way as BMW Motorrad DTC dynamic traction control, energy recovery stability control compares the wheel circumferential velocities of the front and rear wheels calculated from the wheel speeds and the tyre radius. Energy recovery stability control uses this differential to compute slip as a measure of the reserve of stability available at the rear wheel.

If slip overshoots the applicable limit, the energy recovery braking moment is reduced. Slip is reduced and the vehicle is stabilised.

156 ENGINEERING DETAILS

Effect of energy recovery stability control

- In ECO, RAIN and ROAD riding modes: Maximum stability.
- with riding modes Pro^{OE}
- In DYNAMIC riding mode: Compared to RAIN and ROAD riding modes, reduced intervention.

RIDING MODE

Selection

To adapt the E-Scooter to road condition and the desired riding experience, any of the following riding modes can be selected:

Standard

- ECO
 - RAIN
 - ROAD (standard mode)
 - with riding modes Pro^{OE}
- ### with riding modes Pro
- DYNAMIC

For each of these riding modes, there is a matching setting for the ABS, DTC systems, for energy recovery stability control and for throttle response and energy recovery.

Throttle response

- In ECO riding mode: Restrained throttle response and reduced torque.
- In RAIN riding mode: Gentle throttle response.
- In ROAD riding mode: Optimum throttle response.
- with riding modes Pro^{OE}
- In DYNAMIC riding mode: Direct throttle response.

Energy recovery

- In RAIN and ROAD riding modes: Medium energy recovery by deceleration of the vehicle.
- In ECO riding mode: Maximum energy recovery by deceleration of the vehicle.
- with riding modes Pro^{OE}
- In DYNAMIC riding mode: Maximum energy recovery by deceleration of the vehicle.

ABS

- The rear wheel lift-off detection is activated in all riding modes.
- In ECO, RAIN, ROAD and DYNAMIC riding modes, the ABS is set up for on-road riding.

–with riding modes Pro^{OE}

ABS Pro

–ABS Pro is fully available in all riding modes. The stand-up tendency of the E-Scooter, in other words its tendency to straighten up when the brakes are applied with the machine banked for cornering, is reduced to a minimum.

DTC

Tyres

–DTC is set up for on-road riding with road tyres in all riding modes.

Riding stability

- In RAIN riding mode, DTC intervenes early to maximise riding stability.
- In ECO and ROAD riding modes, DTC intervention is later than in RAIN riding mode. This prevents the rear wheel from spinning whenever possible.
- In DYNAMIC riding mode, DTC intervention is later than in ROAD riding mode. This prevents the rear wheel from spinning whenever possible.
- The front wheel is prevented from lifting in all riding modes.

Mode changes

You can switch riding modes at a standstill with operational readiness switched on, or when the vehicle is on the move.

The desired riding mode is initially preselected. The mode change does not take place until the systems in question are all in the appropriate state.

The selection menu does not disappear from the display until the mode change has taken place.

ECO mode

In ECO mode, energy recovery by vehicle deceleration is maximised and acceleration is reduced. The ECO mode is designed for maximum range.

DYNAMIC BRAKE CONTROL

–with riding modes Pro^{OE}

How Dynamic Brake Control works

The Dynamic Brake Control function assists the rider in emergency braking situations.

Detection of emergency braking

–Sudden, sharp application of the front brake is interpreted as emergency braking.

Behaviour in emergency braking

–If emergency braking occurs at a speed in excess of min 10 km/h, the ABS function is further assisted by Dynamic Brake Control.

Behaviour in response to inadvertent actuation of the e-throttle grip

- If the throttle is accidentally opened (e-throttle grip position > 5 %) during emergency braking, Dynamic Brake Control ensures the desired braking effect by ignoring actuation of the e-throttle grip. The effectiveness of emergency braking is ensured.
- If the throttle is closed (throttle grip position < 5 %) while Dynamic Brake Control is in action, the propulsive torque requested by the ABS brake system is restored.
- If emergency braking ceases and the rider still has not changed the position of the throttle grip, Dynamic Brake Control steadily ramps the torque of the electrical machine back to the rider's requested level.

TYRE PRESSURE CONTROL (RDC)

–with tyre pressure control (RDC)^{OE}

Function

A sensor integrated into each tyre measures the air temperature and the air pressure inside the tyre and transmits this information to the control unit. Each sensor has a centrifugal-force tripswitch that does not enable transmission of the measured values until the vehicle has accelerated to a defined minimum speed for the first time.

 Minimum speed for transmission of the RDC measured values:

min 30 km/h

The display shows -- for each tyre until the tyre-pressure signal is received for the first time. The sensors continue to transmit the measured-value signals for some time after the vehicle comes to a stop.

 Time for transmission of measured values after vehicle comes to a stop:

min 15 min

An error message is issued if wheels without sensors are fitted to a vehicle equipped with an RDC control unit.

Tyre pressure ranges

The RDC control unit distinguishes between three tyre pressure ranges matched to the vehicle:

- Tyre pressure within permitted tolerance.
- Tyre pressure close to limit of permitted tolerance.
- Tyre pressure outside permitted tolerance.

Temperature compensation

Tyre pressure is a temperature-dependent variable: pressure increases as tyre air temperature rises and decreases as tyre air temperature drops. Tyre air temperature depends on ambient temperature as well as on the style of riding and the duration of the ride.



The tyre pressures are shown in the TFT display as temperature compensated and always refer to the following tyre air temperature:

20 °C

The air lines available to the public in petrol stations and

motorway service areas have gauges that do not compensate for temperature; the reading shown by a gauge of this nature is the temperature-dependent tyre-air pressure. As a result, the values displayed there usually do not correspond to the values displayed in the TFT display.

Pressure adaptation

Compare the RDC value on the TFT display with the value in the table on the back cover of the Rider's Manual. Then use the air-line gauge at a service station to compensate for the difference between the RDC reading and the value in the table.



Example

According to the operating instructions, the tyre pressure should be:

2.5 bar

The following display is shown in the TFT display:

2.3 bar

So pressure is low by:

0.2 bar

The gauge on the air line shows:

2.4 bar

160 ENGINEERING DETAILS



Example

You must now increase tyre pressure until the value is:

2.6 bar

ADAPTIVE HEADLIGHT

—with adaptive head light^{OE}

How does the adaptive cornering headlight work?

The low-beam unit installed as standard in the headlight consists of two reflectors that produce a low beam from an LED light source. Ride height sensors on front and rear suspension supply data for permanent beam throw adjustment. While the motorcycle is moving straight ahead, pitch compensation keeps the throw of the headlight beam constantly in the optimum, preset range, regardless of ride and load state. With the Adaptive headlight function, the low-beam unit is additionally rotated about an axis to a degree that varies with the bank angle, compensating for the vehicle's angle of lean. The angle of rotation is $70^\circ (\pm 35^\circ)$. Along with pitch compensation, therefore, the throw of the low-beam headlight also com-

pensates for the rider's chosen bank angle through corners.

The two movements are superimposed, so as the motorcycle is steered through a bend the headlight beam is directed into the bend for better illumination of the road ahead. The results are considerably better illumination of the road ahead when the vehicle corners, and a huge increase in active riding safety.

MAINTENANCE

10

GENERAL NOTES	164
STANDARD TOOLKIT	165
BRAKE SYSTEM	165
COOLANT	169
TYRES	170
RIMS AND TYRES	171
LIGHTING	172
TRIM PANEL COMPONENTS	172
BATTERY	174
FUSES	178
DIAGNOSTIC CONNECTOR	180

GENERAL NOTES

The "Maintenance" chapter describes straightforward procedures for checking and replacing certain wear parts.

Special tightening torques are listed as applicable. The tightening torques for the threaded fasteners on your vehicle are listed in the section entitled "Technical data".

Microencapsulated screws

The microencapsulation is a chemical thread-locker. An adhesive compound creates a secure connection between bolt and nut or between screw and component. Consequently, microencapsulated screws are for once-only use and are not intended for re-installation after being slackened.

After removal of the screw, clean the internal thread to remove all traces of thread-locking compound. Always use new microencapsulated screws when re-assembling. Consequently, prior to disassembly make sure that you have suitable tools for cleaning the threads and a new replacement for each screw to be removed. If the job is not done correctly there is no guaran-

tee that the screw will remain secure, which means that you would be putting yourself at risk!

Some of the work calls for special tools and a thorough knowledge of the technology involved. If you are in doubt, consult a specialist workshop, preferably your authorised BMW Motorrad retailer.



DANGER

Maintenance and repair work not in compliance with correct procedure.

Danger to life due to electric shock hazard.

- Work not described here requires special tools and a thorough knowledge of the technology involved.
- Carry out only the tasks described in this section of the manual. Perform the tasks described only with operational readiness switched off. If in doubt consult a specialist workshop, preferably an authorised BMW Motorrad retailer.

**DANGER****Work on the high-voltage system.**

Danger to life

- The vehicle's high-voltage system is a self-contained system. Safety is ensured as long as no work is attempted on the technical components.
- Have all modifications and work on the high-voltage system carried out by an authorised BMW Motorrad dealer with suitably trained personnel.

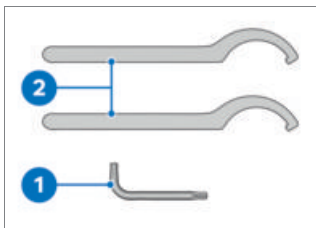
STANDARD TOOLKIT

- 1 Torx wrench, T25
– Removing body panels.
- 2 Hook wrench
– Adjust the spring preload for spring strut.
(→ 113)

BRAKE SYSTEM**Check operation of the brakes**

- Operate right brake lever.
 - » There is a clearly perceptible pressure point.
 - Operate left brake lever.
 - » There is a clearly perceptible pressure point.
 - To test the parking brake, extend the side stand and try to push the E-Scooter forward and back.
 - » E-Scooter cannot be moved.
- If a clear pressure point is not perceptible or if the Scooter can be pushed in either direction:

- Have the brakes checked by an authorised BMW Motorrad retailer.

Checking brake pad thickness, front brakes

- Make sure the ground is level and firm and place the E-Scooter on its stand.



- Visually inspect the left and right brake pads to ascertain their thickness. Viewing direction: from the rear toward brake pads **1**.

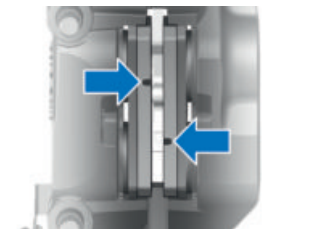

Brake-pad wear limit,
front

min 5.6 mm (Friction lining
with carrier plate)

If the wear indicators, i.e. the grooves, are no longer clearly visible:



WARNING

Brake-pad thickness less than permissible minimum

Diminished braking effect,
damage to the brakes

- In order to ensure the dependability of the brake system, do not permit the brake pads to wear past the minimum permissible thickness.

- Have the brake pads replaced by a specialist workshop, preferably an authorised BMW Motorrad retailer.
- BMW Motorrad recommends installing only genuine OEM brake pads.

Checking brake pad thickness, rear brakes

- Make sure the ground is level and firm and place the E-Scooter on its stand.

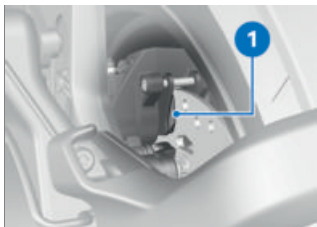

- Visually inspect the brake pads to ascertain their thickness. Viewing direction: from the rear toward brake caliper **1**.

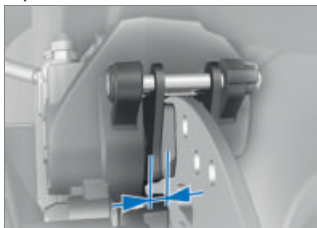

Brake-pad wear limit,
rear

min 4.5 mm (Friction lining
with carrier plate)

If the wear marks have been reached:



WARNING

Brake-pad thickness less than permissible minimum

Diminished braking effect,
damage to the brakes

- In order to ensure the dependability of the brake system, do not permit the brake pads to wear past the minimum permissible thickness.

- Have the brake pads replaced by a specialist workshop, preferably an authorised BMW Motorrad retailer.
- BMW Motorrad recommends installing only genuine OEM brake pads.

Checking brake-fluid level, front and rear wheel brakes

- The brake fluid level can be checked in the sight glasses of the brake fluid reservoirs. The brake fluid reservoir for the front wheel brake is on the right, the brake fluid reservoir for the rear wheel brake is on the left.

WARNING

Not enough brake fluid in brake fluid reservoir, or contaminants in brake fluid

Considerably reduced braking power due to presence of air, contaminants or water in the brake system

- Cease operation of the vehicle immediately and do not ride it until the fault has been rectified.
 - Check the brake-fluid levels at regular intervals.
 - Always make sure that the lid of the brake fluid reservoir and the area around the lid are cleaned before opening.
 - Make sure that only fresh brake fluid from a sealed container is used.
-
- Make sure the ground is level and firm and place the E-Scooter on its stand.
 - Turn the handlebars to a position in which the brake fluid reservoir is horizontal.



- Check the brake fluid level in sight glass **1** of the left or, as applicable, right brake fluid reservoir.



- Wear of the brake pads causes the brake fluid level in the reservoir to sink.



Brake fluid level

Brake fluid, DOT4

It is not permissible for the brake fluid level to be below the **MIN** mark. (Brake-fluid reservoir horizontal)

If the brake fluid level drops below the permitted level:

- Have the fault rectified as quickly as possible by a specialist workshop, preferably an authorised BMW Motorrad retailer.

COOLANT

Check the coolant level

- Make sure the ground is level and firm and place the E-Scooter on its stand.
- Remove the front trim panel. (▮▮▮▮▶ 172)

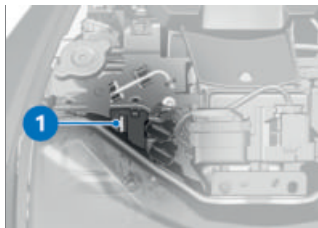

- Check coolant level **1** by visual inspection.



 Specified coolant level in expansion tank

Between **MIN-** and **MAX-** marks (cooling circuit cold)

If the coolant drops below the permitted level:

- Top up the coolant up, or have it topped up by an authorised BMW Motorrad retailer, as soon as possible.
- Install the front trim panel. (▮▮▮▮▶ 172)

Topping up coolant

 **WARNING**

Opening radiator cap

Risk of burning

- Do not open the radiator cap when the system is hot.
- Check and, if necessary, top up the coolant in the expansion tank only.



- Remove the front trim panel. (▮▮▮▮▶ 172)

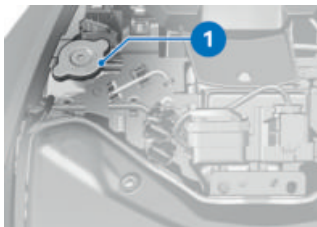

170 MAINTENANCE

- Allow the drive and the cooling system to cool down.



- Open cap 1.
- Top up coolant to specified level.

	Coolant, frost protection
min -25 °C	
	Top-up quantity, coolant
0.07 l	

- Check the coolant level.
( 169)
- Close the cap of the expansion tank.
- Install the front trim panel.
( 172)

TYRES

Checking tyre pressures

WARNING

Incorrect tyre pressure.
Impaired handling characteristics of the Scooter. Shorter useful tyre life.

- Always check that the tyre pressures are correct.



WARNING

Tendency of valve inserts installed vertically to open by themselves at high riding speeds

Sudden loss of tyre pressure

- Install valve caps fitted with rubber sealing rings and tighten firmly.

- Check tyre pressures against the data below.

	Tyre pressure, front
2.3 bar (One-up, tyre cold)	
2.3 bar (Two-up with luggage, tyre cold)	
	Tyre pressure, rear
2.5 bar (One-up, tyre cold)	



Tyre pressure, rear

2.5 bar (Two-up with luggage, tyre cold)

If tyre pressure is too low:

- Correct tyre pressure.

RIMS AND TYRES

Checking rims

- Make sure the ground is level and firm and place the E-Scooter on its stand.
- Visually inspect the rims for defects.
- Have damaged rims checked and, if necessary, replaced by an authorised BMW Motorrad retailer.

Check the tyre tread depth



WARNING

Riding with badly worn tyres

Risk of accident due to impaired handling

- If applicable, have the tyres changed in good time before they wear to the minimum tread depth permitted by law.

- Measure the tyre tread depth in the main tread grooves with wear marks.



Wear indicators are built into the main profile grooves on each tyre. The tyre is worn out when the tyre tread has worn down to the level of the marks. The locations of the marks are indicated on the edge of the tyre, e.g. by the letters TI, TWI or by an arrow.

If the tyre tread is worn to minimum:

- Replace tyre or tyres, as applicable.

Tyre recommendation

For each size of tyre, BMW Motorrad tests and classifies as roadworthy certain makes. BMW Motorrad cannot assess the suitability or provide any guarantee of road safety for other tyres.

BMW Motorrad recommends using only tyres tested by BMW Motorrad.

More detailed information is available from your authorised BMW Motorrad retailer.

- Make sure the ground is level and firm and place the E-Scooter on its stand.

172 MAINTENANCE

LIGHTING

Replacing LED light sources



WARNING

Vehicle overlooked in traffic due to failure of the lights on the vehicle

Safety risk

- Always replace a faulty bulb at the earliest possible opportunity. Consult a specialist workshop, preferably an authorised BMW Motorrad Retailer.

All light sources of the vehicle are LED light sources. The service life of the LED light sources is longer than the presumed vehicle service life. If an LED light source is faulty contact a specialist workshop, preferably an authorised BMW Motorrad retailer.

TRIM PANEL COMPONENTS

Removing front trim panel



- Hold front trim panel **1** by the grip provided for the purpose centred underneath the windscreen and pull the panel forward.
- Disengage front trim panel **1** from detents **2**.
- Work front trim panel **1** forward to remove.

Installing front trim panel

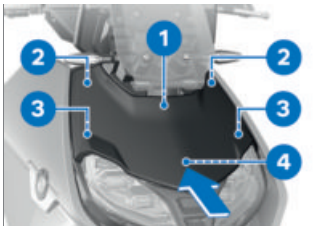

- Position front trim panel **1** in the direction indicated by the arrow.
- Work front trim panel **1** into position with guides **3** and **4**.

- Lightly press front trim panel **1** to engage it in clips **2**.

Removing side trim panel



- Remove screw **2**.
- Remove side trim panel **1**.



- Work battery cover **1** in the direction indicated by the arrow to remove.
- Remove screws **2**.

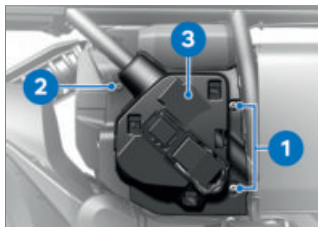

- Remove screws **1**.
- Push back the trim panel component and remove screw **2**.
- Remove the cover **3**.

Installing side trim panel

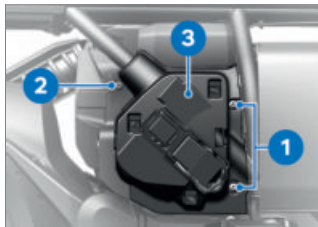

- Hold cover **3** in position.
- Push back the trim panel component and install screw **2**.
- Install screws **1**.

174 MAINTENANCE



- Install screws **2**.
- Hold battery cover **1** in position.
- By pressing from above, push battery cover **1** in the direction indicated by the arrow; the lock must engage with an audible click.
- Check that battery cover **1** is secure.

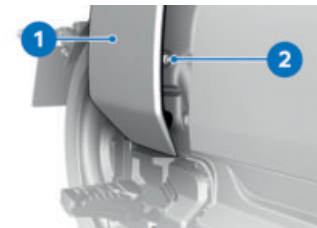

- Engage side trim panel **1** in the detents.
- Install screw **2**.

BATTERY

General notes

Correct upkeep, recharging and storage will prolong the life of the 12 V battery and are essential if warranty claims are to be considered.

Compliance with the points below is important in order to maximise the life of the 12 V battery:

- Keep the surface of the battery clean and dry.
- Be sure to read and comply with the instructions for charging the battery on the following pages.
- Do not turn the battery upside down.

Recharge function

If the state of charge of the 12 V battery drops below a defined threshold, the recharge function is activated. Under these circumstances the 12V battery is charged via the DC/DC transformer by the high-voltage battery. This ensures that the 12 V battery maintains an adequate state of charge.

The recharge function is active in the following situations:

- Vehicle on the move: The 12 V battery is recharged when necessary.
- Charging process in progress: The 12 V battery is recharged in addition to the high-voltage battery.
- During out-of-use periods: The 12 V battery's state of charge is checked very 2 days and the battery is recharged as necessary. Fan and coolant pump noises might be audible while recharging is in progress.

If the 12 V battery required three recharges in succession in the course of a lengthy out-of-use period, On-board battery status. No restrictions. Have it checked by a specialist workshop. appears when operational readiness is switched on. See "Displays" for more information.

If the high-voltage battery's state of charge drops below a critical threshold, the 12 V battery cannot be recharged from this source. An adequate state of charge of the high-voltage

battery has to be ensured in order for the recharging function to be active whenever it is needed.

Charge the 12 V battery



ATTENTION

Charging the connected 12 V battery via the battery terminals

Damage to the vehicle electronics

- Disconnect the 12 V battery at the battery terminals before charging.



ATTENTION

Charging a fully discharged 12 V battery using the 12 V power socket

Damage to the vehicle electronics

- Always charge the **disconnected**, fully discharged 12 V battery at the terminals (battery voltage smaller than 12 V, indicator lights and multifunction display remain off when ignition is switched on).

Replacing 12 V battery

—with anti-theft alarm (DWA)^{OE}

- If applicable, switch off the anti-theft alarm.◀
- Switch off operational readiness.
- Remove the side panel. (▮▮▮ 173)

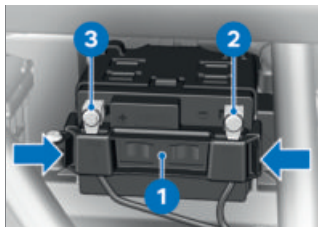

- Squeeze the clips of retainer **1** together at left and right and remove the retainer.

ATTENTION

Battery not disconnected in accordance with correct procedure

Risk of short-circuit

- Always proceed in compliance with the specified disconnection sequence.
- Remove screw **2** and disconnect the negative battery cable.

- Remove screw **3** and disconnect the positive battery cable.
- Remove the 12 V battery from the battery holder.
- Slip the 12 V battery into the battery holder.

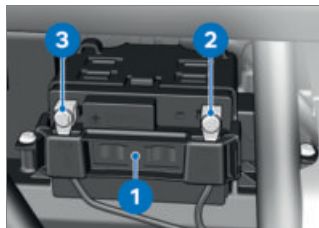

- Install retainer **1** on the 12V battery.

ATTENTION

Battery not connected in accordance with correct procedure

Risk of short-circuit

- Always proceed in compliance with specified installation sequence.
- Hold the positive battery cable in position and install screw **3**.
- Hold the negative battery cable in position and install screw **2**.

178 MAINTENANCE

- Install the side panel.
(173)

FUSES

Replace the main fuse



ATTENTION

Jumpering of blown fuses

Risk of short-circuit and fire

- Never attempt to jumper a blown fuse.
 - Always replace a defective fuse with a new fuse of the same amperage.
- Switch off operational readiness.
 - Make sure the ground is level and firm and place the E-Scooter on its stand.
 - Remove the side panel.
(173)

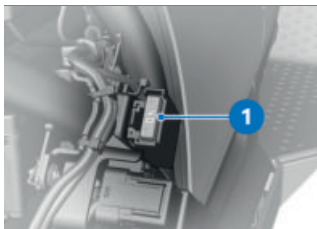

- Replace blown fuse **1**.

If fuse defects recur frequently have the electric circuits checked by a specialist

workshop, preferably an authorised BMW Motorrad dealer.



Main fuse

40 A (Main fuse)

- Install the side panel.
(173)

Replacing fuses

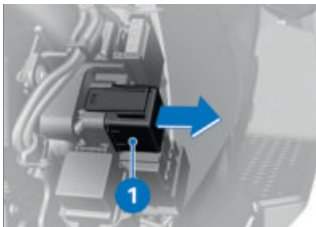

- Switch off operational readiness.
- Remove the side panel.
(173)
- Remove fuse box **1**.

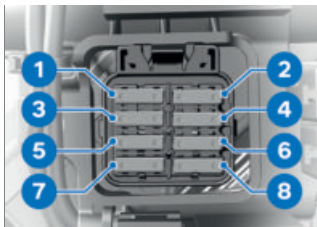
**ATTENTION****Jumpering of blown fuses**

Risk of short-circuit and fire

- Never attempt to jumper a blown fuse.
 - Always replace a defective fuse with a new fuse of the same amperage.
- Consult the fuse assignment diagram and replace blown fuse **1 - 8**.



If fuse defects recur frequently have the electric circuits checked by a specialist workshop, preferably an authorised BMW Motorrad dealer.



Fuse 1

15 A (Electrical machine electronics, relay terminal 30g)



Fuse 2

7.5 A (Terminal 30b, electrical machine electronics, ABS, sensor box, seat heating, USB charging compartment, RDC, storage compartments)



Fuse 3

10 A (Electrical machine electronics)



Fuse 4

7.5 A (Terminal 30, isolating relay terminal 30b, anti-theft alarm system (DWA), ignition lock, instrument cluster, on-board charger, OBD connector)



Fuse 5



7.5 A (Terminal 30C, multi-function switch left, Service Disconnect, electrical machine electronics, on-board charger)



Fuse 6

Not used

180 MAINTENANCE

 Fuse 7
Not used
 Fuse 8
Not used

- Insert the fuse box.
- Install the side panel.
( 173)

DIAGNOSTIC CONNECTOR

Disengaging diagnostic socket



CAUTION

Incorrect disconnection of the diagnostic socket for on-board diagnosis

Malfunctions of the vehicle

- Do not disconnect the diagnostic socket or allow it to be disconnected except in the course of a BMW Motorrad service by a specialist workshop or by other authorised persons.
 - Have the work carried out by appropriately trained personnel.
 - Comply with the stipulations of the vehicle manufacturer.
- Remove the front trim panel.
( 172)

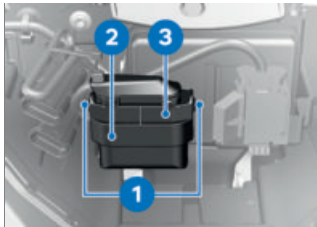

- Press locks **1** on both sides.
- Disengage diagnostic socket **2** from holder **3**.
» The interface to the diagnosis and information system can be connected to the diagnostic connector **2**.

Securing diagnostic socket

- Disconnect the interface for the diagnosis and information system.

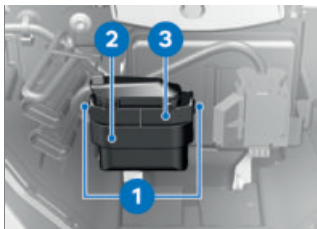

- Insert diagnostic socket **2** into holder **3**.
» Locks **1** engage on both sides.
- Install the front trim panel.
( 172)

ACCESSORIES

11

GENERAL NOTES	184
POWER SOCKETS	184
TOPCASE	185

GENERAL NOTES



CAUTION

Use of other-make products

Safety risk

- BMW Motorrad cannot examine or test each product of outside origin to ensure that it can be used on or in connection with BMW vehicles without constituting a safety hazard. Country-specific official authorisation does not suffice as assurance. Tests conducted by these instances cannot make provision for all operating conditions experienced by BMW vehicles and, consequently, they are not sufficient in some circumstances.
- Use only parts and accessories approved by BMW for your vehicle.

BMW has conducted extensive testing of the parts and accessory products to establish that they are safe, functional and suitable. Consequently, BMW accepts responsibility for the products. BMW accepts no liability whatsoever for parts and accessories that it has not approved.

All modifications must be in compliance with legal requirements. Make sure that the vehicle does not infringe the national road-vehicle construction and use regulations applicable in your country. Your authorised BMW Motorrad retailer can offer expert advice on the choice of genuine BMW parts, accessories and other products. To find out more about accessories go to:

bmw-motorrad.com/equipment

POWER SOCKETS

Connection of electrical devices

- You can start using electrical devices connected to the vehicle's sockets only when operational readiness is switched on.
- The sockets continue to receive power for only 60 seconds after operational readiness is switched off.

Operating electrical accessories

Battery capacity is not monitored while 12 V sockets are in use. The 12 V battery can become fully discharged if aux-

iliary equipment is used for a long time without the high-voltage battery being switched on. Under these circumstances there is no guarantee that the E-Scooter's operational readiness can be established.

Cable routing

- The cables from the power sockets to the auxiliary devices must be routed in such a way that they do not impede the rider.
- The cable routing should not restrict the steering angle or obstruct handling.
- The cables must not be trapped.

TOPCASE

-with topcase^{OA}

Opening topcase



- Turn key **1** clockwise.
- Press and hold down yellow latch **2** and pull out carry handle **3**.



- Push yellow button **1** forwards, simultaneously opening the topcase lid.

Adjust the topcase volume

- Open the topcase and remove all its contents.



- Engage lever **1** in the front limit position for the larger volume.
- Engage lever **1** in the rear limit position for the smaller volume.
- Close the topcase.



Capacity, topcase

25...35 l

186 ACCESSORIES

Closing topcase

- Press down firmly on the topcase lid to close.



ATTENTION

Closure of carrying handle with case lock latched

Damage to locking tab

- Make sure that the topcase lock is vertical when you close the carry handle.
- Close carry handle **1**.
 - » The handle engages with an audible click.
- Turn key **2** anti-clockwise and withdraw.

Removing topcase



- Turn key **1** clockwise.
- Press and hold down yellow latch **2** and pull out carry handle **3**.



- Pull red lever **1** to the rear.
 - » Latching flap **2** pops up.
- Fully open the latching flap.
- Take a firm grip of the handle and lift the topcase out of the holder.

Installing topcase



- Pull red lever **1** to the rear.
» Latching flap **2** pops up.
- Fully open the latching flap.



- Engage the topcase in front holders **1** of the topcase carrier plate.
- Press the rear of the topcase on to the topcase carrier plate.



- Push locking flap **1** forwards until you feel some resistance.
- Then push locking flap and red release lever **2** forwards simultaneously.
» The locking flap engages.



ATTENTION

Closure of carrying handle with case lock latched

Damage to locking tab

- Make sure that the case lock is at right angles to the forward direction of travel when you close the carry handle.

188 ACCESSORIES

- Close carry handle **1**.
 - » The handle engages with an audible click.
- Turn key **2** anti-clockwise and withdraw.

Maximum payload

 Payload of topcase
-with topcase ^{OA}
max 5 kg ◁

CARE

12

CARE PRODUCTS	192
WASHING THE VEHICLE	192
CLEANING EASILY DAMAGED COMPONENTS	194
CARE OF PAINTWORK	195
PAINT PRESERVATION	195
LAYING UP THE E-SCOOTER	196
RESTORING E-SCOOTER TO USE	196

CARE PRODUCTS

BMW Motorrad recommends that you use the cleaning and care products you can obtain from your authorised BMW Motorrad retailer. The substances in BMW Care Products have been tested in laboratories and in practice; they provide optimised care and protection for the materials used in your vehicle.



ATTENTION

Use of unsuitable cleaning and care products

Damage to vehicle parts

- Do not use solvents such as cellulose thinners, cold cleaners, fuel or the like, and do not use cleaning products that contain alcohol.



ATTENTION

Use of strongly acidic or strongly alkaline cleaning agents

Damage to vehicle parts

- Dilute in accordance with the dilution ratio stated on the packaging of the cleaning agent.
- Do not use strongly acidic or strongly alkaline cleaning agents.

WASHING THE VEHICLE

BMW Motorrad recommends that you use BMW insect remover to soften and wash off insects and stubborn dirt on painted parts prior to washing the vehicle.

To prevent stains, do not wash the vehicle immediately after it has been exposed to strong sunlight and do not wash it in the sun.

Remove dirt from the fork legs at regular intervals.

Make sure that the vehicle is washed frequently, especially during the winter months and if it is ridden on roads near the coast.

To remove road salt deposits, clean the vehicle and mounted

parts, as applicable, with cold water immediately after every trip.

 After a ride in the rain, when humidity is high or after the vehicle has been washed, condensation might form inside the headlight. This can cause temporary fogging on the headlight lens. If moisture is constantly present inside the headlight consult a specialist workshop, preferably an authorised BMW Motorrad retailer.



WARNING

Wet brake discs and brake pads after vehicle wash, after riding through water and in rainy conditions

Diminished braking effect, risk of accident

- Apply the brakes in good time to allow the friction and heat to dry the brake discs and brake pads.



ATTENTION

Effect of road salt intensified by warm water

Corrosion

- Use only cold water to remove road salt deposits.



ATTENTION

Damage due to high water pressure from high pressure cleaners or steam cleaners

Corrosion or short circuit, damage to labels, seals, hydraulic brake system, electrical system and the motorcycle seat

- Exercise restraint when using a steam jet or high pressure cleaning equipment.

CLEANING EASILY DAMAGED COMPONENTS

Plastics



ATTENTION

Use of unsuitable cleaning agents

Damage to plastic surfaces

- Do not use cleaning agents that contain alcohol, solvents or abrasives.
- Do not use insect-remover pads or cleaning pads with hard, scouring surfaces.

Clean the plastic parts with water and BMW plastic care product. This includes in particular:

- Windscreen and slipstream deflectors
- Headlight lens made of plastic
- Glass cover of the instrument cluster
- Black, unpainted parts



Soften stubborn dirt and insects by covering the affected areas with a wet cloth.



Clean with water and sponge only.



Do not use any chemical cleaning agents.

TFT display

Clean the TFT display with warm water and washing-up liquid. Then dry it with a clean cloth, e.g. a paper towel.

Chrome

Carefully clean chrome parts with plenty of water and motorcycle cleaner from the BMW Motorrad Care Products range. This is particularly important to counter the effects of salt.

Use BMW Motorrad metal polish for additional treatment.

Radiator

Clean the radiator regularly to prevent overheating of the electrical machine due to inadequate cooling.

For example, use a garden hose with low water pressure.



ATTENTION

Bending of radiator fins

Damage to radiator fins

- Take care not to bend the radiator fins when cleaning.

Rubber

Treat rubber components with water or BMW rubber-care products.



ATTENTION

Application of silicone sprays to rubber seals

Damage to the rubber seals

- Do not use silicone sprays or care products that contain silicon.

CARE OF PAINTWORK

Washing the vehicle regularly will help counteract the long-term effects of substances that can damage the paint, especially if your vehicle is ridden in areas with high air pollution or natural sources of dirt, for example tree resin or pollen.

Remove particularly aggressive substances immediately, however, as otherwise the paint can be affected or become discoloured. Substances of this nature include spilt fuel, oil, grease, brake fluid and bird droppings. For this, we recommend BMW Motorrad solvent cleaner followed by BMW Motorrad gloss polish for preservation.

Marks on the paintwork are particularly easy to see after the motorcycle has been washed. Remove stains of this kind at the earliest possible opportunity, using benzine or petroleum spirit on a clean cloth or ball of cotton wool. BMW Motorrad recommends using BMW tar remover for removing specks of tar. Then apply preserving agent to the areas treated in this way.



ATTENTION

Damage to paintwork due to metal polish

Risk of damage

- Do not treat painted surfaces and chrome-painted surfaces with metal polish.

PAINT PRESERVATION

If water no longer rolls off the paint, the paint must be preserved.

For paint preservation, BMW Motorrad recommends the use of BMW Motorrad gloss polish or agents containing carnauba wax or synthetic wax.



Do not use chrome polish to preserve chrome paints.

196 CARE

Use only the agents recommended by BMW Motorrad.

LAYING UP THE E-SCOOTER



ATTENTION

Damage to the high-voltage battery by excessive discharge

Risk of damage

- Prior to a lengthy out-of-use period of up to four weeks, make sure that the high-voltage battery is fully charged.
- Check the state of charge at regular intervals; recharge the high-voltage battery as necessary.
- Do not leave the vehicle out of use for a lengthy period with the high-voltage battery in a low state of charge.



Do not leave the vehicle parked up for more than 14 days if electric range is less than 10 km.

- Clean the E-Scooter.

–without Canada export^{NV}

–without Taiwan export^{NV}

- Start the charging process.
(123)◀

–with Canada export^{NV}
or

–with Taiwan export^{NV}

- Start the charging process.
(127)◀

- Spray the brake-lever, centre-stand and side-stand pivot mounts with a suitable lubricant.

- Coat bright metal and chrome-plated parts with an acid-free grease (e.g. Vaseline).

- Stand the E-Scooter in a dry room in such a way that there is no load on either wheel.

RESTORING E-SCOOTER TO USE

- Remove the protective wax coating.
- Clean the E-Scooter.
- Checklist. (137)

TECHNICAL DATA

13

TROUBLESHOOTING CHART	200
CHARGING	203
DRIVE	204
TRANSMISSION	205
FINAL DRIVE	205
FRAME	205
CHASSIS AND SUSPENSION	205
BRAKES	206
WHEELS AND TYRES	206
ELECTRICAL SYSTEM	207
ANTI-THEFT ALARM	209
DIMENSIONS	209
WEIGHTS	210
PERFORMANCE FIGURES	210

200 TECHNICAL DATA

TROUBLESHOOTING CHART

Riding readiness cannot be switched on:

Possible cause	Rectification
Side stand extended	Retract the side stand.
Starting without operating the brakes	Operate a brake lever when starting.
12 V battery flat	Charge the 12 V battery. ( 175)

The Bluetooth connection is not established.

Possible cause	Rectification
The steps required for pairing were not carried out.	Check the necessary steps for pairing in the operating instructions for the communication system.
The communication system was not connected automatically despite successful pairing.	Switch off the helmet's communication system and reconnect it after a minute or two.
Too many Bluetooth devices are saved on the helmet.	All pairing entries on the helmet are deleted (see the communication system operating instructions).
There are other vehicles with Bluetooth-capable devices in the vicinity.	Avoid simultaneously pairing with more vehicles.

Bluetooth connection is interrupted.

Possible cause	Rectification
The Bluetooth connection to the mobile device is interrupted.	Switch off energy saving mode.
The Bluetooth connection to the helmet is interrupted.	Switch off the helmet's communication system and reconnect it after a minute or two.
The volume in the helmet cannot be adjusted.	Switch off the helmet's communication system and reconnect it after a minute or two.

The phonebook is not displayed in the TFT display.

Possible cause	Rectification
The phonebook was not transmitted to the vehicle.	Confirm transmission of the phone data ( 108) when pairing the mobile device.

Active route guidance is not displayed in the TFT display.

Possible cause	Rectification
Navigation from the BMW Motorrad Connected app was not transmitted.	Call up the BMW Motorrad Connected app on the paired mobile device prior to departure.
The route guidance cannot be started.	Make sure that the mobile device has a data connection and check the map data on the mobile device.

202 TECHNICAL DATA





Playlist not shown on the TFT display.

Possible cause	Rectification
Too many tracks in the playlist on the mobile device.	Reduce the number of tracks in the playlist on the mobile device.

CHARGING

Total capacity of the high-voltage battery unit	60.6 Ah
Net energy content, high-voltage energy storage system	8.5 kWh
–with power reduction ^{OE}	6.2 kWh
Note, charging time	The figures for charging times are based on the assumption that charging is with the stated charge current. Temperatures and the selected charging infrastructure, charging cable and charge current limitation can prolong the charging time.

204 TECHNICAL DATA

Charging time	
Charging time of the high-voltage battery unit with standard charging cable	 210 min, 80 % charge at charge current: 10 A 260 min, 100 % charge at charge current: 10 A
-with power reduction ^{OE}	 145 min, 80 % charge at charge current: 10 A 200 min, 100 % charge at charge current: 10 A
Charging time of the high-voltage battery unit with Mode3 charging cable	
-with quick charger ^{OE}	 65 min, 80 % charge at charge current: 30 A 100 min, 100 % charge at charge current: 30 A
-with quick charger ^{OE} -with power reduction ^{OE}	 50 min, 80 % charge at charge current: 30 A 70 min, 100 % charge at charge current: 30 A

DRIVE

Engine number location	Underside of electrical machine housing
Engine type	IA0P06A
Engine design	Synchronous machine
-with quick charger ^{OE}	Synchronous machine (3-phase, permanently excited)
Nominal steady-state power	15 kW
-with power reduction ^{OE}	11 kW
Maximum power	31 kW, at rpm: 4900 min ⁻¹
-with power reduction ^{OE}	23 kW, at rpm: 4000 min ⁻¹

Torque	62 Nm, at rpm: 1500 min ⁻¹
Maximum engine speed	max 12300 min ⁻¹

TRANSMISSION

Type of transmission	Single-speed transmission, integrated into electrical machine housing
----------------------	---

FINAL DRIVE

Type of final drive	Toothed-belt drive
Type of rear suspension	Cast light-alloy single-arm swinging arm with cam-adjustable rear wheel axle

FRAME

Frame type	Steel double-cradle frame
Type plate location	Frame, front right on steering head
Position of the vehicle identification number	Main frame front right at bottom

CHASSIS AND SUSPENSION

Front wheel

Type of front suspension	Telescopic forks
Spring travel, front	110 mm, at front wheel

Rear wheel

Design of the rear-wheel suspension	Direct-pivot spring strut with adjustable spring preload
Spring travel at rear wheel	92 mm, at rear wheel

206 TECHNICAL DATA

BRAKES

Front wheel

Type of front brake	Twin disc brake, rigid, diameter 265 mm, 4-piston fixed caliper
Brake-pad material, front	Organic material
Brake disc thickness, front	5 mm, When new min 4.5 mm, Wear limit
Play of brake controls (Front brake)	0.7...3.4 mm, at the piston

Rear wheel

Type of rear brake	Single-disc brake, diameter 265 mm, 1-piston floating caliper
Brake-pad material, rear	Organic material
Brake disc thickness, rear	5 mm, When new min 4.5 mm, Wear limit

WHEELS AND TYRES

Recommended tyre combinations	Your authorised BMW Motorrad retailer will be happy to supply an up-to-date list of the approved wheel/tyre combinations.
Speed category, front/rear tyres	H, required at least: 210 km/h

Front wheel

Front-wheel type	Aluminium cast wheel
Front-wheel rim size	3.50" x 15"
Tyre designation, front	120/70 R 15
Load index, front tyre	56
Permissible front-wheel imbalance	max 5 g

Rear wheel

Rear-wheel type	Aluminium cast wheel
Rear wheel rim size	4.50" x 15"
Tyre designation, rear	160/60 R 15
Load index, rear tyre	67
Permissible rear-wheel imbalance	max 5 g

Tyre pressures

Tyre pressure, front	2.3 bar, One-up, tyre cold 2.3 bar, Two-up with luggage, tyre cold
Tyre pressure, rear	2.5 bar, One-up, tyre cold 2.5 bar, Two-up with luggage, tyre cold

ELECTRICAL SYSTEM

Electrical rating of on-board sockets	max 5 A, Total for all sockets
Main fuse	40 A, Main fuse
Fuse 1	15 A, Electrical machine electronics, relay terminal 30g

208 TECHNICAL DATA

Fuse 2	7.5 A, Terminal 30b, electrical machine electronics, ABS, sensor box, seat heating, USB charging compartment, RDC, storage compartments
Fuse 3	10 A, Electrical machine electronics
Fuse 4	7.5 A, Terminal 30, isolating relay terminal 30b, anti-theft alarm system (DWA), ignition lock, instrument cluster, on-board charger, OBD connector
Fuse 5	7.5 A, Terminal 30C, multi-function switch left, Service Disconnect, electrical machine electronics, on-board charger
Fuse 6	Not used
Fuse 7	Not used
Fuse 8	Not used

Battery

Battery type	AGM battery (Absorbent Glass Mat), maintenance-free
Battery rated voltage	12 V
Battery rated capacity	5 Ah

Lighting

All light sources	LED
-------------------	-----

ANTI-THEFT ALARM

–with anti-theft alarm (DWA)^{OE}

Activation time on arming	approx. 30 s
Alarm duration	approx. 26 s
Battery type	CR 123 A

DIMENSIONS

Length of motorcycle	2285 mm, over number-plate carrier
Height of motorcycle	1150 mm, over windscreen, at DIN vehicle kerb weight
–with windscreen, high ^{OE}	1315 mm, over windscreen, at DIN vehicle kerb weight
Width of motorcycle	855 mm, with mirrors 820 mm, over handlebar weights
Height of rider's seat	780 mm, without rider, at DIN vehicle kerb weight
–with Backrest comfort seat ^{OE}	800 mm, without rider, at DIN vehicle kerb weight
Rider's inside-leg arc, heel to heel	1810 mm, without rider, at DIN vehicle kerb weight
–with Backrest comfort seat ^{OE}	1856 mm, without rider, at DIN vehicle kerb weight

210 TECHNICAL DATA

WEIGHTS

Vehicle kerb weight	231 kg, DIN unladen weight, without OE
Wheel load, front, at unladen weight	119 kg
Permissible gross vehicle weight	410 kg
Wheel load, rear, at unladen weight	112 kg
Maximum payload	179 kg
Payload of topcase	
–with topcase ^{OA}	max 5 kg
Payload of the helmet compartment	max 8 kg
Payload, soft bag	max 5 kg

PERFORMANCE FIGURES

Top speed	120 km/h
Range	130 km, in accordance with WMTC
–with power reduction ^{OE}	100 km, in accordance with WMTC

SERVICE

14

REPORTING SAFETY-RELEVANT DEFECTS	214
RECYCLING	215
BMW MOTORRAD SERVICE	215
BMW MOTORRAD SERVICE HISTORY	216
BMW MOTORRAD MOBILITY SERVICES	217
MAINTENANCE WORK	217
MAINTENANCE SCHEDULE	219
BMW MOTORRAD RUNNING-IN CHECK	220
MAINTENANCE CONFIRMATIONS	221
SERVICE CONFIRMATIONS	233

REPORTING SAFETY-RELEVANT DEFECTS

—with Canada export^{NV}

If you think that your motorcycle has a fault which may cause an accident, injury or death, you must inform the NHTSA (National Highway Traffic Safety Administration) immediately and BMW of North America, LLC.

If the NHTSA receives other similar complaints, it may open an investigation. If it finds that a safety defect exists in a group of vehicles, the NHTSA may order the manufacturer to perform a recall and remedy campaign. However, the NHTSA cannot become involved in individual problems between you, your retailer, or BMW of North America, LLC.

You can contact the NHTSA by calling the Vehicle Safety hotline on 1-888-327-4236 (teletypewriter TTY for the hearing impaired: 1-800-424-9153) for free, by visiting the website at [http:// www.safercar.gov](http://www.safercar.gov) or by writing to Administrator, NHTSA, 400 Seventh Street, SW., Washington, DC 20590. Further information on vehicle safety is available at [http:// www.safercar.gov](http://www.safercar.gov).

Canadian customers who wish to report a safety-related defect to Transport Canada, Defect Investigations and Recalls can call the toll-free hotline 1-800-333-0510. You can also obtain other information about motor vehicle safety from [http:// www.tc.gc.ca/roadsafety](http://www.tc.gc.ca/roadsafety).

RECYCLING

Disposal of an EOL vehicle

BMW Motorrad recommends disposing of a vehicle that has reached the end of its useful life by taking it to a manufacturer-designated receiving centre for EOL vehicles.

In general, the laws of the country in question apply for receiving and recycling of EOL vehicles. Information about recycling and sustainability can be viewed on the country-specific websites of the manufacturer. Additional information can be obtained on request from your authorised BMW Motorrad retailer or another qualified service partner, or from a specialist workshop.

Disposal of the rider's manual

—with France export^{NV}

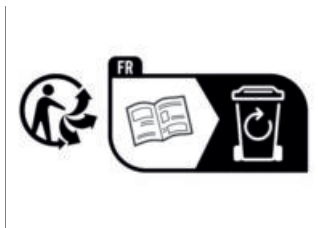

Dispose of this rider's manual by depositing it in the container provided for the purpose.

BMW MOTORRAD SERVICE

BMW Motorrad has an extensive retailer network in place to look after you and your E-Scooter in more than 100 countries. Authorised BMW Motorrad retailers have the technical information and the technical know-how to carry out reliably all preventive maintenance and repair work on your BMW.

You can locate the nearest authorised BMW Motorrad retailer by visiting our website: **bmw-motorrad.com**.



WARNING

Maintenance and repair work not in compliance with correct procedure

Risk of accident due to subsequent damage

- BMW Motorrad recommends you to have all the associated work on your E-Scooter carried out by a specialist workshop, preferably an authorised BMW Motorrad dealer.

In order to help ensure that your BMW is always in optimum condition, BMW Motorrad recommends compliance with the maintenance intervals specified for your E-Scooter.

Have all maintenance and repair work carried out confirmed in the "Service" chapter in this manual. Evidence of regular preventive maintenance is essential for generous treatment of claims submitted after the warranty period has expired.

Your authorised BMW Motorrad retailer can provide information on BMW Motorrad services and the work undertaken as part of each service.

BMW MOTORRAD SERVICE HISTORY

Entries

Maintenance work that has been carried out is entered in the proof of maintenance. The entries are like a Service Booklet and provide proof of regular maintenance.

When an entry is made in the electronic service booklet of the vehicle, service-relevant data is saved in the central IT systems of BMW AG, Munich, Germany.

If there is a change in vehicle ownership, the data saved in the electronic service booklet can also be viewed by the new vehicle owner. A BMW Motorrad retailer or a specialist workshop can also view data that is stored in the electronic service booklet.

Objection

The vehicle owner can object to entries being made by the BMW Motorrad retailer or a specialist workshop in the electronic service booklet along with the corresponding storage of data in the vehicle and transfer of data to the vehicle manufacturer for the period of time that they are the vehicle owner. In this instance, no entry is made in the electronic service booklet of the vehicle.

BMW MOTORRAD MOBILITY SERVICES

As owner of a new BMW E-Scooter, in circumstances in which assistance is required you can benefit from the protection afforded by the various BMW Motorrad mobility services (e.g. Mobile Service, breakdown service, vehicle recovery service).

Your authorised BMW Motorrad retailer will be happy to provide information about the mobility services available to you.

MAINTENANCE WORK

BMW pre-delivery check

Your authorised BMW Motorrad retailer conducts the BMW pre-delivery check before handing over the vehicle to you.

BMW Running-in Check

The BMW running-in check has to be performed when the motorcycle has covered between 500 km and 1200 km.

BMW Motorrad Service

The BMW Motorrad Service is carried out every 24 months or every 10000 km (whichever comes first). The scope of services can vary, depending on the age of the vehicle and the distance it has covered. Your authorised BMW Motorrad retailer confirms that the service work has been carried out and enters the date when the next service will be due.

Riders who cover long distances in a year might have to bring in their vehicles for service before the next scheduled date. It is to allow for these cases that a maximum odometer reading is entered as well in the confirmation of service. Servicing has to be

218 SERVICE

brought forward if this odometer reading is reached before the next scheduled date for the service.

To find out more about service go to:

bmw-motorrad.com/service

The maintenance tasks necessary for your vehicle are set out in the maintenance schedule below:

MAINTENANCE SCHEDULE

	50 000 km 30 000 mls	10 000 km 6 000 mls	20 000 km 12 000 mls	30 000 km 18 000 mls	40 000 km 24 000 mls	50 000 km 30 000 mls	60 000 km 36 000 mls	70 000 km 42 000 mls	80 000 km 48 000 mls	90 000 km 54 000 mls	100 000 km 60 000 mls	12 months	24 months
1	X												
2		X	X	X	X	X	X	X	X	X	X		X ^a
3					X				X				
4													X
5	X				X				X				

- 1 BMW Motorrad Running-in check
 - 2 BMW Motorrad Service, standard scope
 - 3 Replace the belt
 - 4 Change brake fluid, entire system
 - 5 Change transmission oil
- ^a every two years or every 10000 km (whichever comes first)

BMW MOTORRAD RUNNING-IN CHECK

BMW Motorrad running-in check

The tasks included in the BMW Motorrad running-in check are listed below. The actual scope of work applicable for your vehicle may vary.

- Setting service-due data and countdown distance
- Performing vehicle test with BMW diagnostic system
- Checking brake-fluid level, front/rear brakes
- Lubricating side stand and checking Bowden cable for parking brake
- Lubricate the bearer of Bowden cable for parking brake and check the basic setting and braking effect of parking brake
- Removing belt guard, outer
- Changing transmission oil
- Checking belt tension
- Installing outside belt guard
- Check the coolant composition
- Check the tyre pressures and tread depth
- Checking steering-head bearing
- Checking lighting and signalling system
- Function check, start enabling
- Final inspection and check of roadworthiness
- Performing vehicle test with BMW diagnostic system
- Confirm the BMW service in the on-board literature

MAINTENANCE CONFIRMATIONS

BMW Motorrad Service standard scope

The tasks included in the BMW Motorrad Service standard scope are listed below. The actual scope of maintenance work applicable for your vehicle may vary.

- Checking battery state of charge
- Visual inspection of the brake lines, brake hoses and connections
- Changing brake fluid, entire system
- Checking brake-fluid level, front/rear brakes
- Check the front brake pads and brake discs for wear
- Check the rear brake pads and brake disc for wear
- Lubricating side stand and checking Bowden cable for parking brake
- Lubricate the bearer of Bowden cable for parking brake and check the basic setting and braking effect of parking brake
- Replacing belt
- Changing transmission oil
- Checking steering-head bearing
- Check the coolant composition
- Check the tyre pressures and tread depth
- Checking lighting and signalling system
- Function check, start enabling
- Final inspection and check of roadworthiness
- Performing vehicle test with BMW Motorrad diagnostic system
- Performing vehicle test with BMW diagnostic system
- Setting service-due date and countdown distance with BMW Motorrad diagnostic system
- Confirm the BMW Motorrad service in the on-board literature

222 SERVICE

BMW Motorrad pre-delivery check

carried out

on _____

Stamp, signature

BMW Motorrad running-in check

carried out

on _____

odometer reading _____

Next service

at the latest

on _____

or, when reached earlier

odometer reading _____

Stamp, signature

BMW Motorrad service

carried out

on _____

odometer reading _____

Next service

at the latest

on _____

or, when reached earlier

odometer reading _____

Work performed

	Yes	No
BMW Motorrad service	<input type="checkbox"/>	<input type="checkbox"/>
Replace belt	<input type="checkbox"/>	<input type="checkbox"/>
Changing the brake fluid in the entire system	<input type="checkbox"/>	<input type="checkbox"/>
Change gearbox oil	<input type="checkbox"/>	<input type="checkbox"/>

Notes

Stamp, signature

224 SERVICE

BMW Motorrad service

carried out

on _____

odometer reading _____

Next service

at the latest

on _____

or, when reached earlier

odometer reading _____

Work performed

BMW Motorrad service

Yes No

Replace belt

Changing the brake fluid in the entire system

Change gearbox oil

Notes

Stamp, signature

BMW Motorrad service

carried out

on _____

odometer reading _____

Next service

at the latest

on _____

or, when reached earlier

odometer reading _____

Work performed

	Yes	No
BMW Motorrad service	<input type="checkbox"/>	<input type="checkbox"/>
Replace belt	<input type="checkbox"/>	<input type="checkbox"/>
Changing the brake fluid in the entire system	<input type="checkbox"/>	<input type="checkbox"/>
Change gearbox oil	<input type="checkbox"/>	<input type="checkbox"/>

Notes

Stamp, signature

226 SERVICE

BMW Motorrad service

carried out

on _____

odometer reading _____

Next service

at the latest

on _____

or, when reached earlier

odometer reading _____

Work performed

BMW Motorrad service

Yes No

Replace belt

Changing the brake fluid in the entire system

Change gearbox oil

Notes

Stamp, signature

BMW Motorrad service

carried out

on _____

odometer reading _____

Next service

at the latest

on _____

or, when reached earlier

odometer reading _____

Work performed

	Yes	No
BMW Motorrad service	<input type="checkbox"/>	<input type="checkbox"/>
Replace belt	<input type="checkbox"/>	<input type="checkbox"/>
Changing the brake fluid in the entire system	<input type="checkbox"/>	<input type="checkbox"/>
Change gearbox oil	<input type="checkbox"/>	<input type="checkbox"/>

Notes

Stamp, signature

228 SERVICE

BMW Motorrad service

carried out

on _____

odometer reading _____

Next service

at the latest

on _____

or, when reached earlier

odometer reading _____

Work performed

BMW Motorrad service

Yes No

Replace belt

Changing the brake fluid in the entire system

Change gearbox oil

Notes

Stamp, signature

BMW Motorrad service

carried out

on _____

odometer reading _____

Next service

at the latest

on _____

or, when reached earlier

odometer reading _____

Work performed

	Yes	No
BMW Motorrad service	<input type="checkbox"/>	<input type="checkbox"/>
Replace belt	<input type="checkbox"/>	<input type="checkbox"/>
Changing the brake fluid in the entire system	<input type="checkbox"/>	<input type="checkbox"/>
Change gearbox oil	<input type="checkbox"/>	<input type="checkbox"/>

Notes

Stamp, signature

230 SERVICE

BMW Motorrad service

carried out

on _____

odometer reading _____

Next service

at the latest

on _____

or, when reached earlier

odometer reading _____

Work performed

	Yes	No
BMW Motorrad service	<input type="checkbox"/>	<input type="checkbox"/>
Replace belt	<input type="checkbox"/>	<input type="checkbox"/>
Changing the brake fluid in the entire system	<input type="checkbox"/>	<input type="checkbox"/>
Change gearbox oil	<input type="checkbox"/>	<input type="checkbox"/>

Notes

Stamp, signature

BMW Motorrad service

carried out

on _____

odometer reading _____

Next service

at the latest

on _____

or, when reached earlier

odometer reading _____

Work performed

	Yes	No
BMW Motorrad service	<input type="checkbox"/>	<input type="checkbox"/>
Replace belt	<input type="checkbox"/>	<input type="checkbox"/>
Changing the brake fluid in the entire system	<input type="checkbox"/>	<input type="checkbox"/>
Change gearbox oil	<input type="checkbox"/>	<input type="checkbox"/>

Notes

Stamp, signature

232 SERVICE

BMW Motorrad service

carried out

on _____

odometer reading _____

Next service

at the latest

on _____

or, when reached earlier

odometer reading _____

Work performed

BMW Motorrad service

Yes No

Replace belt

Changing the brake fluid in the entire system

Change gearbox oil

Notes

Stamp, signature

CERTIFICATE

15

BMW CE 04 BATTERY CERTIFICATE FOR THE HIGH-VOLTAGE CELL MODULES SERVICES AND CONDITIONS

In relation to the high-voltage cell modules, supplementary to claims in respect of material defects as set out in the terms and conditions of sale and supply for new BMW CE 04 vehicles, the selling, authorised BMW Motorrad retailer issues to the purchaser of a BMW CE 04 new vehicle the following commitments:

- 1.** The BMW CE 04 Battery Certificate for the high-voltage cell modules of the BMW CE 04 new vehicle applies for the first 40,000 km of the BMW CE 04 new vehicle and ends, regardless of the distance covered, no later than five years after initial delivery or initial registration of the BMW CE 04 new vehicle, whichever comes first ("term of certificate").
- 2.** Within the term of certificate the purchaser can stipulate rectification of a defect in the high-voltage cell modules free of charge.
- 3.** If the BMW CE 04 vehicle has to be recovered within the term of certificate on account of a defect in the high-voltage cell modules, the purchaser will receive reimbursement of the costs incurred for recovery and transport to the nearest BMW CE 04 service workshop.
- 4.** For technical reasons, the capacity of a lithium-ion high-voltage battery decreases in the course of its service life (natural wear). If charge-capacity measurement by an authorised BMW Motorrad retailer within the term of certificate establishes that net battery capacity is less than 70 % of the original value on delivery of the BMW CE 04 new vehicle, this percentage capacity below 70 % constitutes an excessive loss of capacity. This excessive loss of capacity will be eliminated free of charge to the purchaser.
- 5.** The purchaser can request the commitments set out in this BMW CE 04 Battery Certificate from the selling authorised BMW Motorrad retailer or any authorised BMW Motorrad retailer in the CE 04 sales markets*.

6. The commitments from the BMW CE 04 Battery Certificate require the inspections to have been undertaken with the regularity specified by the manufacturer and for checks and, if applicable, improvements within the framework of these inspections to have been carried out on the high-voltage cell modules. The commitments do not apply if a defect of the high-voltage cell modules or an excessive loss of capacity is due to accident damage or has occurred because

- the BMW CE 04 vehicle was operated under conditions for which it was not homologated (e.g. in a country with conditions of homologation different from that of the place of initial delivery), or
- the BMW CE 04 was handled incorrectly or overstressed, for example in motorsport competition, or
- parts were installed in the BMW CE 04 vehicle the use of which the manufacturer had not approved, or the BMW CE 04 vehicle of parts thereof (e.g. software) were modified in a way not authorised by the manufacturer, or

- the instructions for handling, maintenance and care of the BMW CE 04 vehicle (particularly as set out in the Rider's Manual) were not followed, or
- the high-voltage battery was opened or removed from the BMW CE 04 vehicle.

7. This BMW CE 04 Battery Certificate is a supplementary part of the terms and conditions of sale and supply for new BMW CE 04 vehicles. Commitments and claims in accordance with the terms and conditions of sale and supply for new BMW CE 04 vehicles are unaffected by the commitments set out in this BMW CE 04 Battery Certificate.

8. A change of owner of the BMW CE 04 vehicle does not affect the commitments set out in the BMW CE 04 Battery Certificate.

* Sales markets are: Andorra, Austria, Belgium, China, Germany, France, Great Britain, Ireland, Italy, Japan, Korea, Liechtenstein, Luxembourg, Monaco, Netherlands, Portugal, Russia, San Marino, Spain, Switzerland, USA.

DECLARATION OF CONFORMITY	241
CERTIFICATE FOR ELECTRONIC IMMOBILISER	244
CERTIFICATE FOR KEYLESS RIDE	247
CERTIFICATE FOR KEYLESS RIDE	249
CERTIFICATE FOR KEYLESS RIDE	251
CERTIFICATE FOR KEYLESS RIDE	253
CERTIFICATE FOR TYRE PRESSURE CONTROL (RE- IFENDRUCK-CONTROL, RDC)	255
CERTIFICATE FOR TFT INSTRUMENT CLUSTER	256

DECLARATION OF CONFORMITY**Manufacturer**

Bayerische Motoren Werke Aktiengesellschaft
Petuelring 130, 80809 Munich, Germany

Hereby, BMW AG declares that the radio equipment components listed below are in compliance with Directive 2014/53/EU and with Radio Equipment Regulations 2017 of the United Kingdom. The full text of the EU/UK declarations of conformity are available at the following internet address:
bmw-motorrad.com/certification



Simplified UK Declaration of Conformity according to Radio Equipment Regulations 2017 of the United Kingdom.



Simplified EU Declaration of Conformity according to EU RED (2014/53/EU).

242 APPENDIX

Technical information

Radio equipment	Component	Frequency band	Output/Transmission Power
EWS4	EWS	134 kHz	50 dB μ V/m
HUF5750	Keyless Ride	434,42 MHz	10 mW
HUF8465	Keyless Ride	134,45 kHz	42 dB μ V/m
HUF5794	Keyless Ride	433,92 MHz	10 mW
HUF8485	Keyless Ride	134,45 kHz	42 dB μ V/m
ZB001	Keyless Ride	134.5 kHz	allowed 66 dB μ A/ m@ 10m
ZB002	Keyless Ride	433.92 MHz	max. 10 dBm e.r.p
TXBM-WMR	DWA	433.05 MHz - 434.79 MHz	18,8 dBm
RDC3	RDC	433.92 MHz	<13 mW
Wus Moto gen 3	RDC	433,05 MHz - 434,79 MHz	<10 mW e.r.p.
MC24MA4	RDC		
WCA Motorrad-Ladestafach	Charging compartment	110 kHz - 115 kHz	< 6 W
ICC6.5in	Instrument Cluster	Bluetooth: 2402 MHz - 2480 MHz WLAN: 2412 MHz - 2462 MHz	Bluetooth: < 4 dBm WLAN: < 20 dBm

Radio equipment	Component	Frequency band	Output/Transmission Power
ICC10in	Instrument Cluster	Bluetooth: 2402 MHz - 2480 MHz WLAN: 2402 MHz - 2472 MHz	Bluetooth: < +4 dBm WLAN: < +14 dBm
MRR e14FCR	ACC	76 - 77 GHz	Peak max. 32 dBm Nom max. 27 dBm
TL1P22	Intelligent emergency call	832 MHz - 862 MHz 880 MHz - 915 MHz 1710 MHz - 1785 MHz 1920 MHz - 1980 MHz 2500 MHz - 2570 MHz 2570 MHz - 2620 MHz GNSS: 1559 MHz-1610 MHz	23 dBm 33 dBm 30 dBm 24 dBm 23 dBm 23 dBm
MCR001	Audio system		

Declaration of Conformity

Radio equipment electronic immobiliser (EWS4)

For all countries without EU

Technical information

Frequency Band: 134 kHz
(Transponder: TMS37145 /
Type DST80, TMS3705
Transponder Base Station IC)
Output Power: 50 dB μ V/m

Manufacturer and Address

Manufacturer:
BECOM Electronics GmbH
Address: Technikerstraße 1,
A-7442 Hochstraß

Argentina

 **RAMATEL**

H-25246

Australia/New Zealand



R-NZ

Brunei



TA No: DTA-007061

United Arab Emirates

TRA
REGISTERED No:
ER89926/20

DEALER No:
DA96133I20

Philippiens



NTC

Type Approved
No.: ESD-RCE-2023298

South Africa



TA-2020/6131

APPROVED

India

ETA-SD-20200905860

Belarus



Indonesia

72790/SDPPI/2021
13349



Dilarang melakukan perubahan
Spesifikasi yang dapat
Menimbulkan gangguan fisik
dan/atau elektromagnetik
terhadap lingkungan sekitarnya

Paraguay

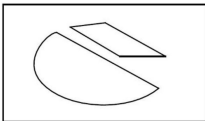

CONATEL

NR: 2020-11-I-0834

Singapore

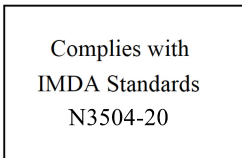

Taiwan



低功 電波 射性電機管 辦法
第十二條 經型式認證合格之低
功率射頻電機，非經許可，公
司、商號或使用者均不得擅 自變
更頻率、加大功率或變更原設計
之特性及 功能。第十四條 低功
率射頻電機之使用不 得影響飛航
安全及干擾合法通信；經發現有
干 擾現象時，應立即停用，並改
善至無干擾時方 得繼續使用。前
項合法通信，指依電信法規定作
業之無線電 通信。

Malaysia



RFCL/47A/0920/S(20-3358)

Israel

מספר אישור אלחוטי של משרד התקשורת הוא
51-74908
אסור להחליף את האנטנה המקורית של המכשיר
ולא
לעשות בו כל שינוי טכני אחר

United States (USA)

Contains FCC ID:

ODE-MREWS5012

FCC § 15.19 Labelling requirements

This device complies with part 15 of the FCC Rules and Industry Canada's licence-exempt RSS standard(s). Operation is subject to the following two conditions:

- (1) this device may not cause interference, and
- (2) this device must accept any interference received, including interference that may cause undesired operation.

FCC § 15.21 Information to user

Changes or modifications not expressly approved by the party responsible for compliance could void the user's authority to operate the equipment.

RF Exposure Requirements

To comply with FCC RF exposure compliance requirements, the device must be installed to provide a separation distance of at least 20 cm from all persons.

Serbia



P1620118300

Canada

Contains IC:

10430A-MREWS5012

This device complies with part 15 of the FCC Rules and Industry Canada license-exempt RSS standard(s). Operation is subject to the following two conditions:

- (1) this device may not cause interference, and
- (2) this device must accept any interference received, including interference that may cause undesired operation.

Le présent appareil est conforme aux CNR d'Industrie Canada applicables aux appareils radio exempts de licence. L'exploitation est autorisée aux deux conditions suivantes : (1) l'appareil ne doit pas produire de brouillage, et (2) l'utilisateur de l'appareil doit accepter tout brouillage radioélectrique subi, même si le brouillage est susceptible d'en compromettre le fonctionnement.

Vietnam

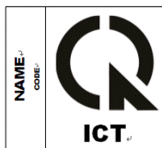

A1109091120AF04A3

Declaration of Conformity

Keyless Ride ECU

For all Countries without EU

Model name: HUF8485

Technical information

Frequenzy band: 134,45 kHz

Output/Transmission Power:
42 dB μ V/m

Manufacturer and Address

Huf H \ddot{u} lsbeck &
F \ddot{u} rst GmbH & Co. KG
Steeger Str. 17,
42551 Velbert, Germany

Argentina

R RAMATEL

H-27411

Morocco

AGREE PAR L'ANRT MAROC
Numéro d'agrément: MR00031290ANRT2022
Date d'agrément: 06/01/2022

Nigeria

Connection and use of this communications
equipment is permitted by the Nigerian
Communications Commission

United Arab Emirates



TRA - United Arab Emirates

Dealer ID: DA36976/14
TA RTTE: ER04912/22
Model: HUF8485
Type: BMW



Malaysia



MCMC
HIDF17000037

Philippines



NTC

Type Approved
No. ESD-RCE-2228692

South Africa



TA-2022/0251

APPROVED

Vietnam



Indonesia

81597/SDPPI/2022



13349

Paraguay

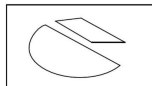

CONATEL

2022-01-I-0052

Pakistan



Oman

OMAN - TRA

R/13020/22

D100428

Singapore

Complies with
IMDA Standards
DA105282

Canada

This device complies with part 15 of the FCC Rules and Industry Canada licence-exempt RSS standard(s). Operation is subject to the following two conditions:

- (1) This device may not cause interference.
- (2) This device must accept any interference, including interference that may cause undesired operation of the device.

Le présent appareil est conforme aux CNR d'Industrie Canada applicables aux appareils radio exempts de licence. L'exploitation est autorisée aux deux conditions suivantes :

- (1) L'appareil ne doit pas produire de brouillage;
- (2) L'utilisateur de l'appareil doit accepter tout brouillage radioélectrique subi, même si le brouillage est susceptible d'en compromettre le fonctionnement.

United States (USA)

This device complies with part 15 of the FCC Rules. Operation is subject to the following two conditions:

- (1) This device may not cause harmful interference.
- (2) This device must accept any interference received, including interference that may cause undesired operation.

CAUTION:

Changes or modifications not expressly approved by the party responsible for compliance could void the user's authority to operate the equipment.

Taiwan

取得審驗證明之低功率射頻器材，非經核准，公司、商號或使用者均不得擅自變更頻率、加大功率或變更原設計之特性及功能。低功率射頻器材之使用

不得影響飛航安全及干擾合法通信；經發現有干擾現象時，應立即停用，並改善至無干擾時方得繼續使用。前述合法通信，指依電信管理法規定作業之

無線電通信。低功率射頻器材須忍受合法通信或工業、科學及醫療用電波輻射性電機設備之干擾

Thailand



nabp.

เครื่องวิทยุคมนาคมนี้ ได้รับความเห็น ไม่ต้องได้
รับใบอนุญาตให้มี ใช้ซึ่งเครื่องวิทยุคมนาคม
หรือตั้งสถานีวิทยุคมนาคมตามประกาศ กสทช.
เรื่อง เครื่องวิทยุคมนาคม และสถานีวิทยุ
คมนาคมที่ได้รับความเห็นไม่ต้องได้รับใบอนุญาต
วิทยุคมนาคมตามพระราชบัญญัติวิทยุคมนาคม
พ.ศ. 2498



nabp. | โทรคมนาคม
กำกับดูแลเพื่อประชาชน
Call Center 1200 (InswS)

Declaration of Conformity

Keyless Ride Key

For all Countries without EU

Model name: HUF5794

Technical information

Frequenzy band: 433,92 MHz

Output/Transmission Power:

10 mW

Manufacturer and Address

Huf Hülsbeck &

Fürst GmbH & Co. KG

Steeger Str. 17,

42551 Velbert, Germany

Oman

OMAN - TRA
R/13021/22
D100428

Morocco

AGREE PAR L'ANRT MAROC
Numéro d'agrément: MR00031289ANRT2022
Date d'agrément: 06/01/2022

Nigeria

Connection and use of this communications equipment is permitted by the Nigerian Communications Commission
--

United Arab Emirates



TRA - United Arab Emirates
Dealer ID: DA36976/14
TA RTTE: ER04909/22
Model: HUF5794
Type: BMW



Malaysia



Philippines



South Africa



Vietnam



Indonesia



Paraguay



Pakistan



Belarus



Serbia



Singapore

Complies with IMDA Standards DA105282

Canada

This device complies with part 15 of the FCC Rules and Industry Canada licence-exempt RSS standard(s). Operation is subject to the following two conditions:

- (1) This device may not cause interference.
- (2) This device must accept any interference, including interference that may cause undesired operation of the device.

Le présent appareil est conforme aux CNR d'Industrie Canada applicables aux appareils radio exempts de licence. L'exploitation est autorisée aux deux conditions suivantes :

- (1) L'appareil ne doit pas produire de brouillage;
- (2) L'utilisateur de l'appareil doit accepter tout brouillage radioélectrique subi, même si le brouillage est susceptible d'en compromettre le fonctionnement.

United States (USA)

This device complies with part 15 of the FCC Rules. Operation is subject to the following two conditions:

- (1) This device may not cause harmful interference.
- (2) This device must accept any interference received, including interference that may cause undesired operation.

CAUTION:

Changes or modifications not expressly approved by the party responsible for compliance could void the user's authority to operate the equipment.

Taiwan

取得審驗證明之低功率射頻器材，非經核准，公司、商號或使用者均不得擅自變更頻率、加大功率或變更原設計之特性及功能。低功率射頻器材之使用

不得影響飛航安全及干擾合法通信；經發現有干擾現象時，應立即停用，並改善至無干擾時方得繼續使用。前述合法通信，指依電信管理法規定作業之

無線電通信。低功率射頻器材須忍受合法通信或工業、科學及醫療用電波輻射性電機設備之干擾

Thailand



nabp.

เครื่องวิทยุคมนาคมนี้ ได้รับยกเว้น ไม่ต้องได้รับใบอนุญาตให้มี ใช้ซึ่งเครื่องวิทยุคมนาคมหรือตั้งสถานีวิทยุคมนาคมตามประกาศ กสทช. เรื่อง เครื่องวิทยุคมนาคม และสถานีวิทยุคมนาคมที่ได้รับยกเว้นไม่ต้องได้รับใบอนุญาตวิทยุคมนาคมตามพระราชบัญญัติวิทยุคมนาคม พ.ศ. 2498



nabp. | โทรคมนาคม
กำกับดูแลเพื่อประชาชน
Call Center 1200 (InswS)

Declaration of Conformity

Keyless Ride ECU

For all Countries without EU

Model name: HUF8465

Technical information

Frequenzy band: 134,45 kHz

Output/Transmission Power:
42 dB μ V/m

Manufacturer and Address

Huf H \ddot{u} lsbeck &
F \ddot{u} rst GmbH & Co. KG
Steeger Str. 17,
42551 Velbert, Germany

Argentina

RAMATEL

H-27885

Morocco

AGREE PAR L'ANRT MAROC

Numéro d'agrément: MR 9389 ANRT 2014

Date d'agrément: 24/06/2014

Nigeria

Connection and use of this communications
equipment is permitted by the Nigerian
Communications Commission

United Arab Emirates



TRA – United Arab Emirates

Dealer ID: DA36976/14
TA RTTE: ER59309/17
Model: HUF8465
Type: ELV incl. ECU



Malaysia



MCMC
HIDF17000037

Philippines



NTC

Type Approved

No. ESD-1409281C

South Africa



TA-2014/886

APPROVED

Vietnam



Indonesia

81555/SDPPI/2022

13349



Paraguay

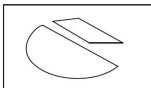

CONATEL

2020-05-I-0278

Singapore

Complies with
IMDA Standards
DA101586

Canada

This device complies with part 15 of the FCC Rules and Industry Canada licence-exempt RSS standard(s). Operation is subject to the following two conditions:

- (1) This device may not cause interference.
- (2) This device must accept any interference, including interference that may cause undesired operation of the device.

Le présent appareil est conforme aux CNR d'Industrie Canada applicables aux appareils radio exempts de licence. L'exploitation est autorisée aux deux conditions suivantes :

- (1) L'appareil ne doit pas produire de brouillage;
- (2) L'utilisateur de l'appareil doit accepter tout brouillage radioélectrique subi, même si le brouillage est susceptible d'en compromettre le fonctionnement.

United States (USA)

This device complies with part 15 of the FCC Rules. Operation is subject to the following two conditions:

- (1) This device may not cause harmful interference.
- (2) This device must accept any interference received, including interference that may cause undesired operation.

CAUTION:

Changes or modifications not expressly approved by the party responsible for compliance could void the user's authority to operate the equipment.

Taiwan

取得審驗證明之低功率射頻器材，非經核准，公司、商號或使用者均不得擅自變更頻率、加大功率或變更原設計之特性及功能。低功率射頻器材之使用

不得影響飛航安全及干擾合法通信；經發現有干擾現象時，應立即停用，並改善至無干擾時方得繼續使用。前述合法通信，指依電信管理法規定作業之

無線電通信。低功率射頻器材須忍受合法通信或工業、科學及醫療用電波輻射性電機設備之干擾

Thailand



nabp.

เครื่องวิทยุคมนาคมนี้ ได้รับยกเว้น ไม่ต้องได้รับใบอนุญาตให้มี ใช้ซึ่งเครื่องวิทยุคมนาคมหรือตั้งสถานีวิทยุคมนาคมตามประกาศ กสทช. เรื่อง เครื่องวิทยุคมนาคม และสถานีวิทยุคมนาคมที่ได้รับยกเว้นไม่ต้องได้รับใบอนุญาตวิทยุคมนาคมตามพระราชบัญญัติวิทยุคมนาคม พ.ศ. 2498



nabp. | โทรคมนาคม

กำกับดูแลเพื่อประชาชน
Call Center 1200 (Inswr)

Declaration of Conformity

Keyless Ride Key

For all Countries without EU

Model name: HUF5750

Technical information

Frequenzy band: 434,42 MHz

Output/Transmission Power:

10 mW

Manufacturer and Address

Huf Hüsbeck &

Fürst GmbH & Co. KG

Steeger Str. 17,

42551 Velbert, Germany

Argentina

CNC COMISIÓN NACIONAL
DE COMUNICACIONES

H-17115

Morocco

AGREE PAR L'ANRT MAROC

Numéro d'agrément: MR 8851 ANRT 2014

Date d'agrément: 17/01/2014

Nigeria

Connection and use of this communications
equipment is permitted by the Nigerian
Communications Commission

United Arab Emirates



TRA - United Arab Emirates

Dealer ID: DA36976/14

TA RTE: ER57698/17

Model: HUF5750

Type: RF transceiver for BMW Motorcycles



Malaysia



MCMC

HIDF17000037

Paraguay

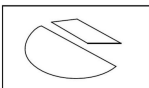

CONATEL

2020-05-I-0277

Philippines



NTC

Type Approved

No. ESD-1408693C

Belarus



South Africa



TA-2013/1674

APPROVED

Vietnam



THACO AUTO
C9000248

ICT

Singapore

Complies with
IMDA Standards
DA101586

Indonesia

81556/SDPPI/2022



13349

Serbia



M005 19

Canada

This device complies with part 15 of the FCC Rules and Industry Canada licence-exempt RSS standard(s). Operation is subject to the following two conditions:

- (1) This device may not cause interference.
- (2) This device must accept any interference, including interference that may cause undesired operation of the device.

Le présent appareil est conforme aux CNR d'Industrie Canada applicables aux appareils radio exempts de licence. L'exploitation est autorisée aux deux conditions suivantes :

- (1) L'appareil ne doit pas produire de brouillage;
- (2) L'utilisateur de l'appareil doit accepter tout brouillage radioélectrique subi, même si le brouillage est susceptible d'en compromettre le fonctionnement.

United States (USA)

This device complies with part 15 of the FCC Rules. Operation is subject to the following two conditions:

- (1) This device may not cause harmful interference.
- (2) This device must accept any interference received, including interference that may cause undesired operation.

CAUTION:

Changes or modifications not expressly approved by the party responsible for compliance could void the user's authority to operate the equipment.

Taiwan

取得審驗證明之低功率射頻器材，非經核准，公司、商號或使用者均不得擅自變更頻率、加大功率或變更原設計之特性及功能。低功率射頻器材之使用

不得影響飛航安全及干擾合法通信；經發現有干擾現象時，應立即停用，並改善至無干擾時方得繼續使用。前述合法通信，指依電信管理法規定作業之

無線電通信。低功率射頻器材須忍受合法通信或工業、科學及醫療用電波輻射性電機設備之干擾

Thailand



nabp.

เครื่องวิทยุคมนาคมนี้ ได้รับยกเว้น ไม่ต้องได้รับใบอนุญาตให้มี ใช้ซึ่งเครื่องวิทยุคมนาคมหรือตั้งสถานีวิทยุคมนาคมตามประกาศ กสทช. เรื่อง เครื่องวิทยุคมนาคม และสถานีวิทยุคมนาคมที่ได้รับยกเว้นไม่ต้องได้รับใบอนุญาตวิทยุคมนาคมตามพระราชบัญญัติวิทยุคมนาคม พ.ศ. 2498



nabp. | โทรคมนาคม

กำกับดูแลเพื่อประชาชน
Call Center 1200 (Inswr)

Certification Tire Pressure Control (TPC)

FCC ID: MRXBC54MA4
IC: 2546A-BC54MA4

FCC ID: MRXBC5A4
IC: 2546A-BC5A4

This device complies with Part 15 of the FCC Rules and with Industry Canada license-exempt RSS standard(s).

Operation is subject to the following two conditions:

- (1) This device may not cause harmful interference, and
- (2) This device must accept any interference received, including interference that may cause undesired operation.

WARNING: Changes or modifications not expressly approved by the party responsible for compliance could void the user's authority to operate the equipment. The term "IC:" before the radio certification number only signifies that Industry Canada technical specifications were met.

Le présent appareil est conforme aux CNR d'Industrie Canada applicables aux appareils radio exempts de licence. L'exploitation est autorisée aux deux conditions suivantes:

- (1) l'appareil ne doit pas produire de brouillage, et
- (2) l'utilisateur de l'appareil doit accepter tout brouillage radioélectrique subi, même si le brouillage est susceptible d'en compromettre le fonctionnement.

WARNING: Changes or modifications not expressly approved by the party responsible for compliance could void the user's authority to operate the equipment. The term "IC:" before the radio certification number only signifies that Industry Canada technical specifications were met.

Declaration of Conformity

Radio equipment TFT instrument cluster

For all Countries without EU

Model name: ICC10in

Technical information

The ICC10in can operate in one of two operating modes:

1. Normal mode, with Bluetooth and WLAN on, and
2. Radio off mode (only available during vehicle manufacturing).

BT operating frq. Range:
2402 – 2480 MHz

BT version: 4.2 (no BTLE)

BT output power:

< +4 dBm (internal antenna)

WLAN operating frq. Range:
2402 – 2472 MHz

WLAN standards:

IEEE 802.11 b/g/n

WLAN output power:

< +14 dBm (internal antenna)

Manufacturer and Address

Manufacturer:

Robert Bosch GmbH

Address:

Robert-Bosch-Platz 1,
70839 Gerlingen, Germany

Turkey

Robert Bosch GmbH, ICC10in tipi telsiz sisteminin 2014/53/EU nolu yönetmeliğe uygun olduğunu beyan eder. AB Uygunluk Beyanı'nın tam metni, aşağıdaki internet adresinden görülebilir: <http://cert.bosch-carmultimedia.net>

Brazil

Este equipamento não tem direito de proteção contra interferência prejudicial e não pode causar interferência em sistemas devidamente autorizados. Para maiores informações, consulte o site da ANATEL www.anatel.gov.br

Thailand

เครื่องโทรคมนาคมและอุปกรณ์นี้ มีความสอดคล้องตามข้อกำหนดของ กทช.
(This telecommunication equipments is in compliance with NTC requirements)

Argentina

 **RAMATEL**

C-25636

Canada

This device contains licence-exempt transmitter(s)/ receiver(s) that comply with Innovation, Science and Economic Development Canada's licence-exempt RSS(s). Operation is subject to the following two conditions:

- (1) This device may not cause interference.
- (2) This device must accept any interference, including interference that may cause undesired operation of the device.

Radiofrequency radiation exposure Information: This equipment complies with Canada radiation exposure limits set forth for an uncontrolled environment. This equipment should be installed and operated with minimum distance of 20 centimeters between the radiator and your body. This transmitter must not be co-located or operating in conjunction with any other antenna or transmitter.

L'émetteur/récepteur exempt de licence contenu dans le présent appareil est conforme aux CNR d'Innovation, Sciences et Développement économique Canada applicables aux appareils radio exempts de licence. L'exploitation est autorisée aux deux conditions suivantes :

- (1) L'appareil ne doit pas produire de brouillage;
- (2) L'appareil doit accepter tout brouillage radioélectrique subi, même si le brouillage est susceptible d'en compromettre le fonctionnement.

Informations sur l'exposition aux radiofréquences:

Cet équipement est conforme aux limites d'exposition aux radiations fixées par le Canada pour un environnement non contrôlé. Cet équipement doit être installé et utilisé avec une distance minimale de 20 centimètres entre le radiateur et votre corps. Cet émetteur ne doit pas être co-localisée ou opérant en conjonction avec autre antenne ou émetteur.

United States (USA)

This device complies with part 15 of the FCC Rules. Operation is subject to the following two conditions:

- (1) This device may not cause harmful interference, and
- (2) this device must accept any interference received, including interference that may cause undesired operation.

Changes or modifications made to this equipment not expressly approved by Robert Bosch GmbH may void the FCC authorization to operate this equipment.

NOTE: This equipment has been tested and found to comply with the limits for a Class B digital device, pursuant to Part 15 of the FCC Rules. These limits are designed to provide reasonable protection against harmful interference in a residential installation. This equipment generates, uses and can radiate radio frequency energy and, if not installed and used in accordance with the instructions, may cause harmful interference to radio communications.

However, there is no guarantee that interference will not occur in a particular installation. If this equipment does cause harmful interference to radio or television reception, which can be determined by turning the equipment off and on, the user is encouraged to try to correct the interference by one or more of the following measures:

- Reorient or relocate the receiving antenna.
- Increase the separation between the equipment and receiver.
- Connect the equipment into an outlet on a circuit different from that to which the receiver is connected.
- Consult the dealer or an experienced radio/TV technician for help.

Radiofrequency radiation exposure Information: This equipment complies with FCC radiation exposure limits set forth for an uncontrolled environment. This equipment should be installed and operated with minimum distance of 20 cm between the radiator and your body. This transmitter must not be co-located or operating in conjunction with any other antenna or transmitter.

Japan

This device is granted pursuant to the Japanese Radio Law (電波法) and the Japanese

Telecommunications Business Law (電気通信事業法)

本製品は、電波法と電気通信事業法に基づく適合証明を受けております。

This device should not be modified (otherwise the granted designation number will become invalid)

本製品の改造は禁止されています。
(適合証明番号などが無効となります。)



R 201-200559

T 20 0138 201

Korea

Equipment Name: BMW A-Kombi

Basic model number: ICC10in

Manufacturer/Country of Origin:

Robert Bosch GmbH / 포르투갈

Zertifikatsnummer:

R-R-BO2-ICC10in

Serbia



ID: I1011 20

Mexico

La operación de este equipo está sujeta a las siguientes dos condiciones:

- (1) es posible que este equipo o dispositivo no cause interferencia perjudicial y
- (2) este equipo o dispositivo debe aceptar cualquier interferencia, incluyendo la que pueda causar su operación no deseada.



Taiwan, Republic of

取得審驗證明之低功率射頻器材，非經核准，公司、商號或使用者均不得擅自變更頻率、加大功率或變更原設計之特性及功能。低功率射頻器材之使用不得影響飛航安全及干擾合法通信；經發現有干擾現象時，應立即停用，並改善至無干擾時方得繼續使用。前述合法通信，指依電信管理法規定作業之無線電通信。低功率射頻器材須忍受合法通信或工業、科學及醫療用電波輻射性電機設備之干擾。

260 INDEX

- 1**
- 12 V battery
 - charging, 175, 176
 - general notes, 174
 - Position on the vehicle, 19
 - Recharge function, 174
 - replacing, 177
 - Technical data, 208
 - Warning indicators, 47, 48
- 12 V socket
 - Notes on use, 184
 - Position on the vehicle, 19
- A**
- Abbreviations and symbols, 4
- ABS
 - Engineering details, 150
 - Self-diagnosis, 139
 - Warning indicators, 55, 56
- Adaptive Headlight, 160
- Ambient temperature, 38
- ASC
 - Engineering details, 153
 - Self-diagnosis, 140
 - Warning indicators, 48, 49
- B**
- Beam throw
 - Adjusters, 18
 - adjusting, 112
- Bluetooth, 97
- Brake fluid
 - Checking fill level, 167
 - Fluid reservoir, 18, 19
- Brake pads
 - Check, 165, 166
 - Running in, 143
- Brakes
 - ABS Pro in detail, 152
 - Checking operation, 165
 - Safety information, 144
 - Technical data, 206
- C**
- Care
 - Care products, 192
 - Chrome, 194
 - Paintwork preservation, 195
 - Washing the vehicle, 192
- Charging
 - Charge current, 123
 - Charging cable, 120
 - charging process, 123, 127, 131, 132
 - Overview, 29
 - State of charge, 94
 - Technical data, 203
 - Warning indicators, 43, 44, 45, 46, 47
- Charging process
 - ending, 131, 132
 - starting, 123, 127
- Chassis and suspension, 205
- Check control, 30
- Checklist, 137
- Clock, 95
- Coolant
 - Checking fill level, 169
 - Fluid reservoir, 18
 - topping up, 169
 - Warning indicators, 45

D

- Daytime riding lights
 - automatic daytime riding light, 70, 71, 72
 - Control, 20
 - operating, 70
- Diagnostic connector
 - disengaging, 180
 - Position on the vehicle, 18
 - securing, 180
- Dimensions, 209
- Drive, 204
- Drive indicator, 93
- DTC
 - Engineering details, 153
 - Warning indicators, 48, 49
- DWA
 - Indicator light, 23
 - operating, 75
 - Technical data, 209
 - Warning indicators, 41
- Dynamic Brake Control, 157

E

- Electrical system, 207
- Emergency call
 - automatic, 66, 67
 - Control, 21
 - Language, 65
 - manual, 65
 - Notes, 12
 - Warning indicators, 54
- Emergency off switch (kill switch)
 - Control, 21, 22
 - operating, 64
- Energy recovery
 - Restriction, 93
 - Warning indicators, 46

E-Scooter

- care, 190
- cleaning, 190
- lashing, 146
- laying up, 196
- parking, 145
- restoring to use, 196

F

- Favourites buttons
 - Assigning functions, 93
 - Control, 20
- Final drive, 205
- Frame, 205
- Fuses
 - Position on the vehicle, 19
 - replacing, 178

G

- General views
 - Indicator and warning lights, 26
 - Instrument cluster, 23
 - Left multifunction switch, 20
 - left side of vehicle, 18
 - My vehicle, 100
 - Right multifunction switch, 21, 22
 - right side of vehicle, 19
 - TFT display in Charging view, 29
 - TFT display in Menu view, 28
 - TFT display in Pure Ride view, 27

262 INDEX

- H**
 - Hazard warning flashers, 72
 - Control, 20
 - Headlight, 112
 - Heated handlebar grips, 78
 - Helmet compartment
 - Emergency unlocking, 82
 - operating, 81
 - Position on the vehicle, 19
 - High-voltage battery
 - State of charge, 94
 - Technical data, 203
 - High-voltage system, 42, 43, 44, 46
 - Horn, 20
- I**
 - Immobiliser, 62
 - Indicator lights
 - Instrument cluster, 23
 - Overview, 26
 - Instructions for loading, 136
 - Instrument cluster
 - Ambient-light brightness sensor, 23
 - Overview, 23
- K**
 - Keyless Ride
 - Battery empty or loss of radio-operated key, 62
 - Electronic immobiliser EWS, 62
 - Engaging steering lock, 60
 - Warning indicators, 38, 39
 - Keys, 60
- L**
 - Lighting
 - replacing, 172
 - Technical data, 208
 - Warning indicators, 39
 - Lights
 - Adaptive headlight, 160
 - automatic daytime riding light, 70, 71, 72
 - Control, 20
 - Daytime riding light, 70
 - Headlight courtesy delay feature, 69
 - Headlight flasher, 69
 - High-beam headlight, 69
 - Low-beam headlight, 68
 - Parking lights, 69
 - Side light, 68
 - Luggage, 136
- M**
 - Maintenance confirmations, 221
 - Maintenance intervals, 217
 - Maintenance schedule, 219
 - Media, 106
 - Menu, 90
 - Mirrors, 112
 - Mobility services, 217
 - Multifunction switch
 - Overview, left side, 20
 - Overview, right side, 21, 22
- N**
 - Navigation, 104
- O**
 - On-board computer, 103
 - Operational readiness, 61

P

- Pairing, 97
- Payload table, 19
- Performance figures, 210
- Phone, 107
- Power
 - Restriction, 93
 - Warning indicators, 43
- Pre-Ride-Check, 138
- Pure, 94
- Pure Ride
 - Overview, 27
 - View, 93

R

- Radio-operated key
 - Replacing battery, 63
 - Warning indicators, 38, 39
- Range, 94
- RDC
 - Engineering details, 158
 - Warning indicators, 49, 51, 52, 53
- Rear footrests
 - Position on the vehicle, left, 18
 - Position on the vehicle, right, 19
- Rear grab handle
 - Position on the vehicle, left, 18
 - Position on the vehicle, right, 19
- Recycling, 215
- Reversing
 - Control, 20
 - operating, 67

Ride readiness

- Control, 21, 22
 - Display, 141
 - restore, 138
 - switching on, 141
- Riding mode
- adjusting, 73
 - Engineering details, 156
- RSC, 155
- Running in, 143

S

- Safety instructions
 - for brake, 144
 - for riding, 136
 - Seat heating, 78
 - Service
 - BMW Motorrad Service, 215
 - Reporting safety-relevant defects, 214
 - Service history, 216
 - Warning indicators, 57
 - Service-due indicator, 56
 - Speed Limit Info, 92
 - Splitscreen, 94, 95
 - Spring preload
 - Adjuster, rear, 18
 - adjusting, 113
 - Status line, top, 91
 - Stowage compartment
 - operating, 79
 - Position on the vehicle, 19
- T**
- TFT display
 - Controls, 87
 - Instrument cluster, 23
 - operating, 90
 - Overview, charging, 29

264 INDEX

- Overview, Menu, 28
- Overview, Pure Ride, 27
- Splitscreen, 94
- Top status line, 91
- Toolkit
 - Contents, 165
 - Position on the vehicle (hook wrench), 19
 - Position on the vehicle (Torx T25), 18
- Topcase, 185
- Transmission, 205
- Transportation, 146
- Trim panels
 - Front trim panel, 172
 - Side panel, 173
- Troubleshooting chart, 200
- Turn indicators, 73
 - Control, 20
- Type plate, 19
- Tyres
 - Checking tread depth, 171
 - Checking tyre pressure, 170
 - Pressures, 207
 - Recommendations, 171
 - Running in, 144
- V**
 - Vehicle Identification
 - Number, 19
- W**
 - Warning indicator lights
 - 12 V battery, 47, 48
 - ABS, 55, 56
 - Anti-theft alarm, 41
 - ASC, 48, 49
 - Bulb faulty, 39
 - Charging, 43, 44, 45, 46, 47
 - Coolant, 45
 - DTC, 48, 49
 - Electric drive, 44, 45
 - Electrical machine control unit, 42
 - Electrical machine electronics, 42
 - Emergency call, 54
 - Energy recovery, 46
 - High-voltage system, 42, 43, 44, 46
 - Insulation fault, 42, 43
 - Keyless Ride, 38, 39
 - Light control failed, 40
 - Mode of presentation, 30
 - My vehicle, 100
 - Outside temperature warning, 38
 - Power, 43
 - RDC, 49, 51, 52, 53
 - Service, 57
 - Side stand, 54
 - State of charge, 43
 - Warning light, drive malfunction, 42
 - Warning light, drive malfunction, 42
 - Warning lights
 - Instrument cluster, 23
 - Overview, 26
 - Warnings, overview, 32
 - Weights, 210
 - Wheels
 - Checking rims, 171
 - Technical data, 206
 - WIFI, 99

Details described or illustrated in this booklet may differ from the vehicle's actual specification as purchased, the accessories fitted or the national-market specification. No claims will be entertained as a result of such discrepancies.

Dimensions, weights, fuel consumption and performance data are quoted to the customary tolerances.

The right to modify designs, equipment and accessories is reserved.

Errors and omissions excepted.

© 2022 Bayerische Motoren
Werke Aktiengesellschaft
80788 Munich, Germany

Not to be reproduced by any means whatsoever, wholly or in part, without the written permission of BMW Motorrad, After Sales.

Original rider's manual, printed in Germany.

Important data:

Charging time

Charging time of the high-voltage battery unit with standard charging cable



210 min, 80 % charge at charge current: 10 A
260 min, 100 % charge at charge current: 10 A

–with power reduction^{OE}



145 min, 80 % charge at charge current: 10 A
200 min, 100 % charge at charge current: 10 A

Charging time of the high-voltage battery unit with Mode3 charging cable

–with quick charger^{OE}



65 min, 80 % charge at charge current: 30 A
100 min, 100 % charge at charge current: 30 A

–with quick charger^{OE}

–with power reduction^{OE}



50 min, 80 % charge at charge current: 30 A
70 min, 100 % charge at charge current: 30 A

Tyre pressures

Tyre pressure, front

2.3 bar, One-up, tyre cold
2.3 bar, Two-up with luggage, tyre cold

Tyre pressure, rear

2.5 bar, One-up, tyre cold
2.5 bar, Two-up with luggage, tyre cold

For further information on all aspects of your vehicle, visit: [bmw-motorrad.com](https://www.bmw-motorrad.com)

